

ADAM

Owner's Manual



Contents

Introduction	2
In brief	6
Keys, doors and windows	21
Seats, restraints	34
Storage	53
Instruments and controls	72
Lighting	110
Climate control	118
Driving and operating	128
Vehicle care	164
Service and maintenance	213
Technical data	217
Customer information	230
Index	238

Introduction

Fuel	Designation	<input type="text"/>		
Engine oil	Grade	<input type="text"/>		
	Viscosity	<input type="text"/>		
Tyre pressure	Tyre size		Front	Rear
	Summer tyres	<input type="text"/>	<input type="text"/>	<input type="text"/>
	Winter tyres	<input type="text"/>	<input type="text"/>	<input type="text"/>
Weights	Gross vehicle weight rating	<input type="text"/>		
	- Kerb weight, basic model	<input type="text"/>		
	= Loading	<input type="text"/>		

Vehicle specific data

Please enter your vehicle's data on the previous page to keep it easily accessible. This information is available in the sections "Service and maintenance" and "Technical data" as well as on the identification plate.

Introduction

Your vehicle is a designed combination of advanced technology, safety, environmental friendliness and economy.

This Owner's Manual provides you with all the necessary information to enable you to drive your vehicle safely and efficiently.

Make sure your passengers are aware of the possible risk of accident and injury which may result from improper use of the vehicle.

You must always comply with the specific laws and regulations of the country that you are in. These laws may differ from the information in this Owner's Manual.

Disregarding the description given in this manual may affect your warranty.

When this Owner's Manual refers to a workshop visit, we recommend your Opel Service Partner.

For gas vehicles we recommend an Opel Repairer authorised for servicing gas vehicles.

All Opel Service Partners provide first-class service at reasonable prices. Experienced mechanics trained by Opel work according to specific Opel instructions.

The customer literature pack should always be kept ready to hand in the vehicle.

Using this manual

- This manual describes all options and features available for this model. **Certain descriptions, including those for display and menu functions, may not apply to your vehicle due to model variant, country specifications, special equipment or accessories.**
- The "In brief" section will give you an initial overview.

- The table of contents at the beginning of this manual and within each section shows where the information is located.
- The index will enable you to search for specific information.
- This Owner's Manual depicts left-hand drive vehicles. Operation is similar for right-hand drive vehicles.
- The Owner's Manual uses the engine identifier code. The corresponding sales designation and engineering code can be found in the section "Technical data".
- Directional data, e.g. left or right, or front or back, always relate to the direction of travel.
- Displays may not support your specific language.
- Display messages and interior labelling are written in **bold** letters.

Danger, Warnings and Cautions

Danger

Text marked ** Danger** provides information on risk of fatal injury. Disregarding this information may endanger life.

Warning

Text marked ** Warning** provides information on risk of accident or injury. Disregarding this information may lead to injury.

Caution

Text marked **Caution** provides information on possible damage to the vehicle. Disregarding this information may lead to vehicle damage.

Symbols

Page references are indicated with ⇨.
⇨ means "see page".

Page references and index entries refer to the indented headings given in the section table of content.

We wish you many hours of pleasurable driving.

Adam Opel GmbH

In brief

Initial drive information

Vehicle unlocking



Press  to unlock the doors and load compartment. Open the doors by pulling the handles.



To open the tailgate, press the brand emblem at the bottom half.

Radio remote control ⇨ 22, Central locking system ⇨ 23, Load compartment ⇨ 26.

Seat adjustment

Longitudinal adjustment



Pull handle, slide seat, release handle. Try to move the seat back and forth to ensure that the seat is locked in place.

Seat position ⇨ 35, Seat adjustment ⇨ 36.

Backrest inclination



Turn handwheel to adjust inclination. Do not lean on backrest while adjusting.

Seat position ⇨ 35, Seat adjustment ⇨ 36, Seat folding ⇨ 37.

Seat height

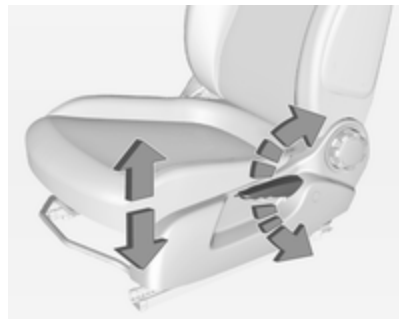

Lever pumping motion

up : seat higher
down : seat lower

Seat position ⇨ 35, Seat adjustment ⇨ 36.

Head restraint adjustment

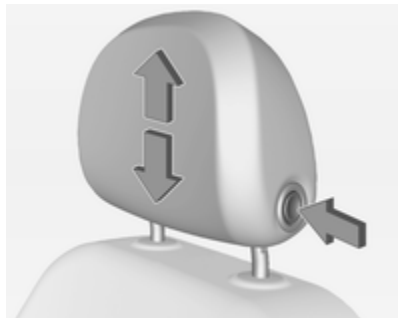

Press release button, adjust height, engage.

Head restraints ⇨ 34.

Seat belt



Pull out the seat belt and fasten in belt buckle. The seat belt must not be twisted and must fit close against the body. The backrest must not be tilted back too far (maximum approx. 25 °).

To unfasten belt, press red button on belt buckle.

Seat position ⇨ 35, Seat belts ⇨ 39, Airbag system ⇨ 41.

Mirror adjustment

Interior mirror



To adjust the mirror, move the mirror housing in the desired direction.

Manual anti-dazzle interior mirror ⇨ 30.

Automatic anti-dazzle interior mirror ⇨ 30.

Exterior mirrors



Select the relevant exterior mirror and adjust it.

Convex exterior mirrors ⇨ 29,
Electric adjustment ⇨ 29, Folding
exterior mirrors ⇨ 29.

Heated exterior mirrors ⇨ 29.

Steering wheel adjustment



Unlock the lever, adjust the steering
wheel, then engage the lever and
ensure it is fully locked.

Do not adjust the steering wheel
unless the vehicle is stationary and
the steering wheel lock has been
released.

Airbag system ⇨ 41, Ignition
positions ⇨ 129.

Instrument panel overview

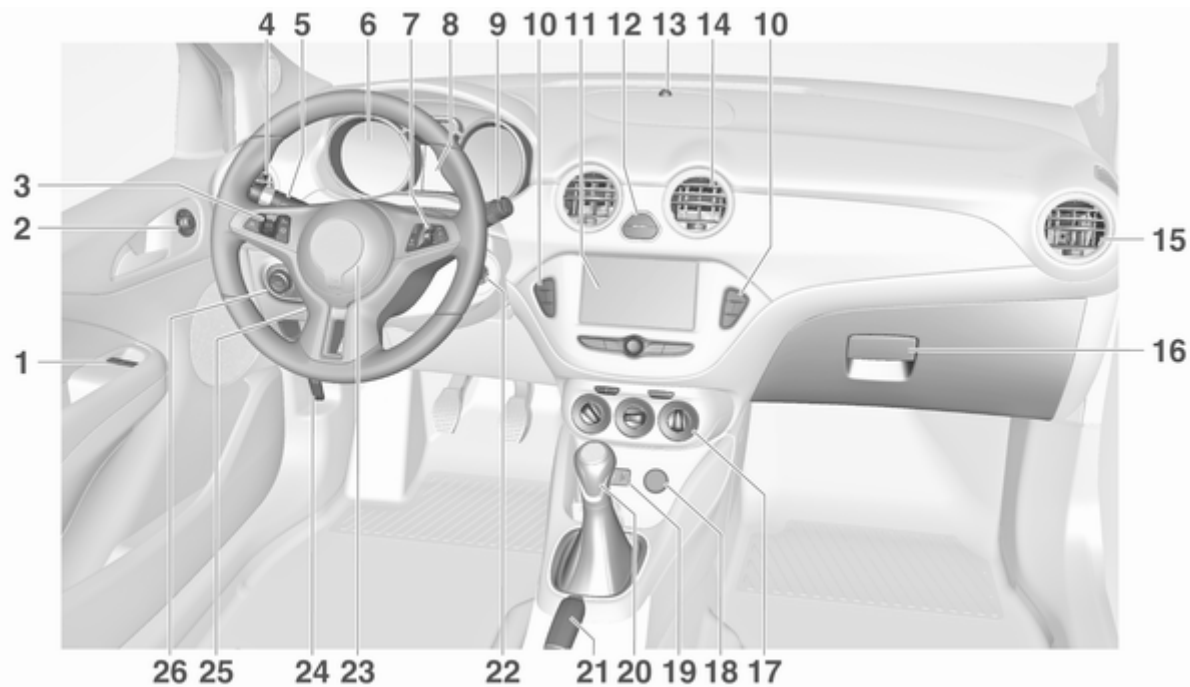

<p>1 Power windows 30</p> <p>2 Exterior mirrors 29</p> <p>3 Cruise control 145</p> <p style="padding-left: 20px;">Speed limiter 146</p> <p>4 Side air vents 126</p> <p>5 Turn and lane-change signals, headlight flash, low beam and high beam 113</p> <p style="padding-left: 20px;">Exit lighting 116</p> <p style="padding-left: 20px;">Parking lights 113</p> <p style="padding-left: 20px;">Buttons for Driver Information Centre 92</p> <p>6 Instruments 81</p> <p>7 Infotainment controls 73</p> <p>8 Driver Information Centre 92</p> <p>9 Windscreen wiper, windscreen washer system, rear wiper, rear washer system 74</p> <p>10 Central locking system 23</p> <p style="padding-left: 20px;">City mode 143</p> <p style="padding-left: 20px;">Fuel selector 82</p> <p style="padding-left: 20px;">Eco button for stop-start system 131</p>	<p style="padding-left: 20px;">Traction Control system 141</p> <p style="padding-left: 20px;">Electronic Stability Control . 142</p> <p style="padding-left: 20px;">Parking assist 148</p> <p style="padding-left: 20px;">Seat heating 38</p> <p style="padding-left: 20px;">Heated steering wheel 73</p> <p>11 Colour-Info-Display 97</p> <p style="padding-left: 20px;">Graphic-Info-Display 98</p> <p>12 Hazard warning flashers 112</p> <p style="padding-left: 20px;">Control indicator for airbag deactivation 88</p> <p style="padding-left: 20px;">Control indicator for front passenger seat belt 87</p> <p>13 Anti-theft alarm system status LED 27</p> <p>14 Centre air vents 126</p> <p>15 Side air vents passenger side 126</p> <p>16 Glovebox 53</p> <p>17 Climate control system 118</p> <p>18 Power outlet 78</p> <p>19 AUX input, USB input 10</p> <p>20 Selector lever, transmission 135</p> <p>21 Parking brake 140</p>	<p>22 Ignition switch with steering wheel lock 129</p> <p>23 Horn 74</p> <p style="padding-left: 20px;">Driver airbag 45</p> <p>24 Bonnet release lever 166</p> <p>25 Steering wheel adjustment . . 73</p> <p>26 Light switch 110</p> <p style="padding-left: 20px;">Headlight range adjustment 112</p> <p style="padding-left: 20px;">Rear fog light 113</p> <p style="padding-left: 20px;">Fuse box 184</p> <p style="padding-left: 20px;">Brightness of instrument panel illumination 114</p> <p style="padding-left: 20px;">Brightness of ambient light 114</p>
--	--	--

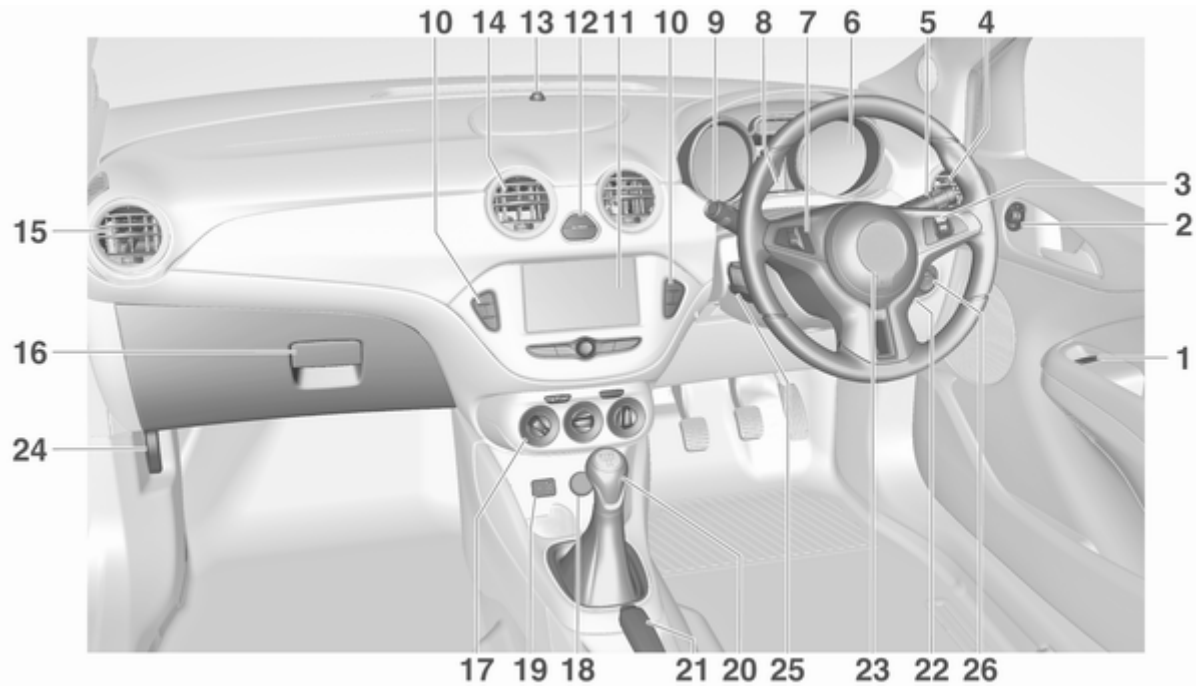

<p>1 Power windows 30</p> <p>2 Exterior mirrors 29</p> <p>3 Cruise control 145</p> <p style="padding-left: 20px;">Speed limiter 146</p> <p>4 Side air vents 126</p> <p>5 Turn and lane-change signals, headlight flash, low beam and high beam 113</p> <p style="padding-left: 20px;">Exit lighting 116</p> <p style="padding-left: 20px;">Parking lights 113</p> <p style="padding-left: 20px;">Buttons for Driver Information Centre 92</p> <p>6 Instruments 81</p> <p>7 Steering wheel controls 73</p> <p>8 Driver Information Centre 92</p> <p>9 Windscreen wiper, windscreen washer system, headlight washer system, rear wiper, rear washer system 74</p> <p>10 Central locking system 23</p> <p style="padding-left: 20px;">City mode 143</p> <p style="padding-left: 20px;">Fuel selector 82</p>	<p style="padding-left: 20px;">Eco button for stop-start system 131</p> <p style="padding-left: 20px;">Traction Control system 141</p> <p style="padding-left: 20px;">Electronic Stability Control . 142</p> <p style="padding-left: 20px;">Parking assist 148</p> <p style="padding-left: 20px;">Seat heating 38</p> <p style="padding-left: 20px;">Heated steering wheel 73</p> <p>11 Colour-Info-Display 97</p> <p style="padding-left: 20px;">Graphic-Info-Display 98</p> <p>12 Hazard warning flashers 112</p> <p style="padding-left: 20px;">Control indicator for airbag deactivation 88</p> <p style="padding-left: 20px;">Control indicator for front passenger seat belt 87</p> <p>13 Anti-theft alarm system status LED 27</p> <p>14 Centre air vents 126</p> <p>15 Side air vents passenger side 126</p> <p>16 Glovebox 53</p> <p style="padding-left: 20px;">Fuse box 184</p> <p>17 Climate control system 118</p> <p>18 Power outlet 78</p>	<p>19 AUX input, USB input 10</p> <p>20 Selector lever, transmission 135</p> <p>21 Parking brake 140</p> <p>22 Ignition switch with steering wheel lock 129</p> <p>23 Horn 74</p> <p style="padding-left: 20px;">Driver airbag 45</p> <p>24 Bonnet release lever 166</p> <p>25 Steering wheel adjustment . . 73</p> <p>26 Light switch 110</p> <p style="padding-left: 20px;">Headlight range adjustment 112</p> <p style="padding-left: 20px;">Rear fog light 113</p> <p style="padding-left: 20px;">Brightness of instrument panel illumination 114</p> <p style="padding-left: 20px;">Brightness of ambient light 114</p>
---	--	--

Exterior lighting

Light switch



Turn light switch:

- ⊙ : lights off
- ☞☞ : sidelights
- ☞☞☞ : headlights

Light switch with automatic light control



- AUTO** : automatic light control:
exterior lighting is switched
on and off automatically
- ⊙ : activation or deactivation of
the automatic light control
- ☞☞ : sidelights
- ☞☞☞ : headlights

Automatic light control ⇨ 111.

Rear fog light

Press ⊙☞ in the light switch.

Headlight flash, high beam and low beam

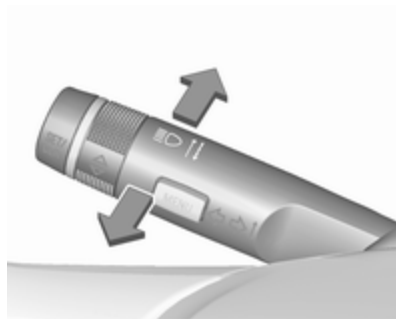

- headlight flash : pull lever
- high beam : push lever
- low beam : push or pull lever

High beam ⇨ 111, Headlight flash
⇨ 111.

Turn and lane-change signals



lever up : right turn signal
lever down : left turn signal

Turn and lane-change signals
↪ 113, Parking lights ↪ 113.

Hazard warning flashers



Operated by pressing .
Hazard warning flashers ↪ 112.

Horn

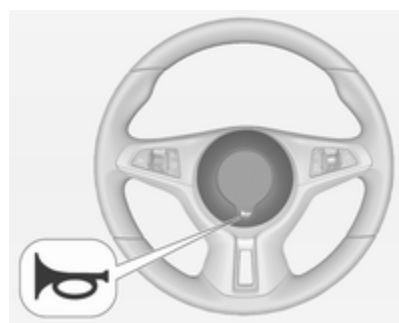

Press .

Washer and wiper systems

Windscreen wiper

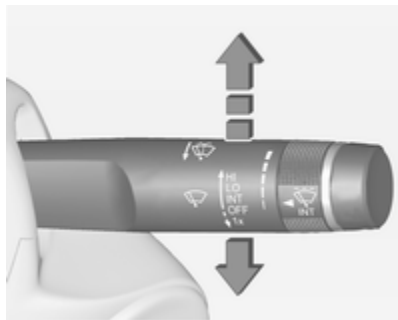

HI : fast

LO : slow

INT : interval wiping

or

automatic wiping with rain sensor

OFF : off

For a single wipe when the windscreen wiper is off, press the lever down to position **1x**.

Windscreen wiper ⇨ 74, Wiper blade replacement ⇨ 171.

Windscreen washer



Pull lever.

Windscreen washer system ⇨ 74,
Washer fluid ⇨ 168.

Rear window wiper



Press the rocker switch to activate the rear window wiper:

ON : continuous operation

OFF : off

INT : intermittent operation

Rear window washer



Push lever.

Washer fluid is sprayed on the rear window and the wiper wipes a few times.

Rear window wiper/washer ⇨ 75.

Climate control

Heated rear window



The heating is operated by pressing .

Heated rear window ⇨ 32.



Heated exterior mirrors

Pressing  also activates the heated exterior mirrors.

Heated exterior mirror ⇨ 29.

Demisting and defrosting the windows



- Set air distribution control to .
- Press .
- Set temperature control to warmest level.
- Set fan speed to highest level.
- Switch on heated rear window .
- Open side air vents as required and direct them towards the door windows.

Climate control system ⇨ 118.

Transmission

Manual transmission



Reverse: with the vehicle stationary, depress clutch pedal and press the release button on the selector lever and engage the gear.

If the gear does not engage, set the lever to neutral, release the clutch pedal and depress again; then repeat gear selection.

Manual transmission ⇨ 135.

Manual transmission automated

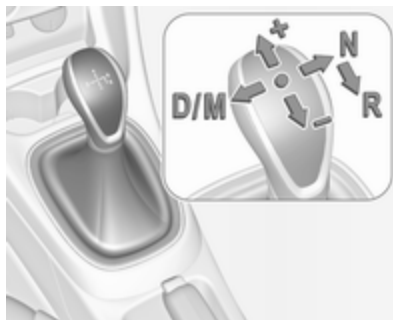

N : neutral position

D/M : switch between automatic (**D**) and manual (**M**) shift mode. **D** or **M** is indicated in the transmission display

+ : upshifting in manual mode

- : downshifting in manual mode

R : reverse, engage only when vehicle is stationary

Manual transmission automated

⇨ 135.

Starting off

Check before starting off

- tyre pressure and condition
⇨ 188, ⇨ 228
- engine oil level and fluid levels
⇨ 167
- all windows, mirrors, exterior lighting and number plates are free from dirt, snow and ice and are operational
- proper position of mirrors, seats, and seat belts ⇨ 29, ⇨ 35, ⇨ 40
- brake function at low speed, particularly if the brakes are wet

Starting the engine

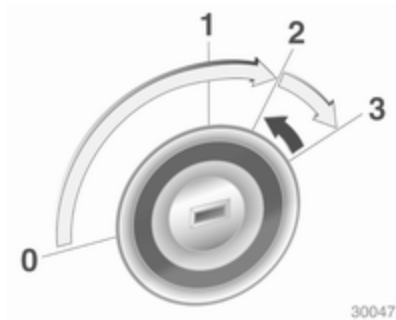

- Turn key to position **1**.
- Move the steering wheel slightly to release the steering wheel lock.
- Manual transmission: operate clutch and brake pedal.
Manual transmission automated: operate brake pedal.
- Do not operate accelerator pedal.
- Turn key to position **3** and release.

Starting the engine ⇨ 130.

Stop-start system

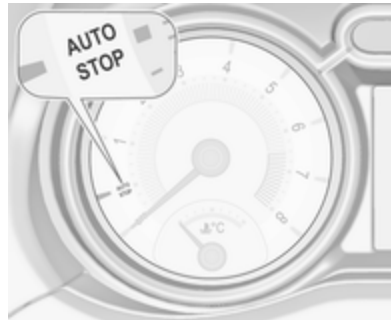

If the vehicle is at a low speed or at a standstill and certain conditions are fulfilled, activate an Autostop as follows:

Vehicles with manual transmission

- Depress the clutch pedal.
- Engage neutral gear.
- Release the clutch pedal.

An Autostop is indicated by the needle at the **AUTOSTOP** position in the tachometer.

To restart the engine, depress the clutch pedal again.

Vehicles with manual transmission automated

If the vehicle is at a standstill with depressed brake pedal, Autostop is activated automatically, indicated by the needle at the **AUTOSTOP** position in the tachometer.

Release the brake pedal or move selector lever out of **D** to restart the engine.

Stop-start system ⇨ 131.

Parking

⚠ Warning

- Do not park the vehicle on an easily ignitable surface. The high temperature of the exhaust system could ignite the surface.
- Always apply the parking brake. Activate the parking brake without pressing the release button. Apply as firmly as possible on a downhill slope or uphill slope. Depress brake pedal at the same time to reduce operating force.
- Switch off the engine.
- If the vehicle is on a level surface or uphill slope, engage first gear before removing the ignition key. On an uphill slope, turn the front wheels away from the kerb.

If the vehicle is on a downhill slope, engage reverse gear before removing the ignition

key. Turn the front wheels towards the kerb.

- Close the windows and the sunroof.
- Remove the ignition key from the ignition switch. Turn the steering wheel until the steering wheel lock is felt to engage.

For vehicles with manual transmission automated, the key can only be removed from the ignition switch when the parking brake is applied.

- Lock the vehicle by pressing  on the radio remote control. Activate the anti-theft alarm system ⇨ 27.
- The engine cooling fans may run after the engine has been switched off ⇨ 166.

Caution

After running at high engine speeds or with high engine loads, operate the engine briefly at a low load or run in neutral for approx. 30 seconds before switching off, in order to protect the turbocharger.

Keys, locks ⇨ 21, Laying-up the vehicle for a long period of time ⇨ 165.

Keys, doors and windows

Keys, locks	21
Keys	21
Car Pass	22
Radio remote control	22
Memorised settings	23
Central locking system	23
Automatic locking	25
Doors	26
Load compartment	26
Vehicle security	27
Anti-theft locking system	27
Anti-theft alarm system	27
Immobiliser	28
Exterior mirrors	29
Convex shape	29
Electric adjustment	29
Folding mirrors	29
Heated mirrors	29
Interior mirrors	30
Manual anti-dazzle	30
Automatic anti-dazzle	30
Windows	30
Windscreen	30

Power windows	30
Heated rear window	32
Sun visors	32
Roof	32
Sunroof	32
Glass panel	33

Keys, locks

Keys

Caution
Do not attach heavy or bulky items to the ignition key.

Replacement keys

The key number is specified in the Car Pass or on a detachable tag.

The key number must be quoted when ordering replacement keys as it is a component of the immobiliser system.

Locks ⇨ 209.

The code number of the adapter for the locking wheel bolts is specified on a card. It must be quoted when ordering a replacement adapter.

Wheel changing ⇨ 198.

Key with foldaway key section



Press button to extend. To fold the key, first press the button.

Car Pass

The Car Pass contains security-related vehicle data and should therefore be kept in a safe place.

When the vehicle is taken to a workshop, this vehicle data is needed in order to perform certain operations.

Radio remote control



Used to operate:

- central locking system
- anti-theft locking system
- anti-theft alarm system
- power windows

The radio remote control has a range of approx. 20 metres. It can be restricted by external influences. The hazard warning flashers confirm operation.

Handle with care, protect from moisture and high temperatures and avoid unnecessary operation.

Fault

If the central locking system cannot be operated with the radio remote control, it may be due to the following:

- The range is exceeded.
- The battery voltage is too low.
- Frequent, repeated operation of the radio remote control while not in range, which will require re-synchronisation.
- Overload of the central locking system by operating at frequent intervals, the power supply is interrupted for a short time.
- Interference from higher-power radio waves from other sources.

Unlocking ⇨ 23.

Basic settings

Some settings can be changed in the Info-Display.

Vehicle personalisation ⇨ 102.

Radio remote control battery replacement

Replace the battery as soon as the range reduces.



Batteries do not belong in household waste. They must be disposed of at an appropriate recycling collection point.

Key with foldaway key section

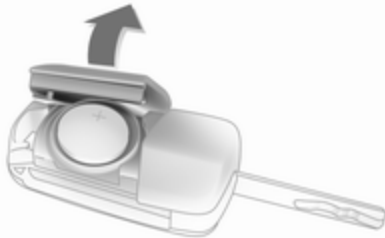

Extend the key and open the unit. Replace the battery (battery type CR 2032), paying attention to the installation position. Close the unit and synchronise.

Key with fixed key section

Have the battery replaced by a workshop.

Memorised settings

Whenever the key is removed from the ignition switch, the following settings are automatically memorised by the key:

- lighting
- Infotainment system presets
- central locking system
- comfort settings
- climate control

The saved settings are automatically used the next time the memorised key is inserted into the ignition switch and turned to position 1 ⇨ 129.

A precondition is that **Personalization by driver** is activated in the personal settings of the Info-Display. This must be set for each key used.

Vehicle personalisation ⇨ 102.

Central locking system

Unlocks and locks doors, load compartment and fuel filler flap.

A pull on an interior door handle unlocks the respective door.

Note

In the event of an accident in which airbags or belt pretensioners are deployed, the vehicle is automatically unlocked.

Note



Three minutes after unlocking with the remote control, the doors are relocked automatically if no door has been opened.

Unlocking



Press .

Two settings are selectable in the Info-Display:

- To unlock only the driver's door, load compartment and fuel filler flap, press  once. To unlock both doors, press  twice.
- Press  once to unlock doors, load compartment and fuel filler flap.

Vehicle personalisation ⇨ 102.

The setting can be saved for the key being used.

Memorised settings ⇨ 23.

Unlocking and opening the tailgate
⇨ 26.

Locking

Close doors, load compartment and fuel filler flap.



Press .

If the driver's door is not closed properly, the central locking system will not work.

Central locking buttons

Locks or unlocks doors, the load compartment and fuel filler flap from inside the passenger compartment.



Press  to lock.

Press  to unlock.

Delayed door lock

Switch off engine and remove key from the lock. Press  with at least one door opened and three chimes will sound. When the last door is closed, the vehicle will automatically lock all doors after five seconds and a feedback is given. After ten minutes, the vehicle will automatically lock all doors even if a door is still open. This function may be activated or deactivated in the Info-Display. Vehicle personalisation ⇨ 102.

Fault in radio remote control system

Unlocking



Manually unlock the driver's door by turning the key in the lock. Switch on the ignition and press the central locking button  to unlock the passenger door, load compartment and fuel filler flap.

By switching on the ignition, the anti-theft locking system is deactivated.

Locking

Manually lock the driver's door by turning the key in the lock.

Fault in central locking system

Unlocking

Manually unlock the driver's door by turning the key in the lock. The passenger door can be opened by pulling the interior handle. The load compartment and fuel filler flap cannot be opened.

To deactivate the anti-theft locking system, switch on the ignition .

Locking

Press inside locking knob of passenger door. Then close the driver's door and lock it from the outside with the key. The fuel filler flap and tailgate cannot be locked.

Automatic locking

This security feature can be configured to automatically lock doors, load compartment and fuel filler flap as soon as a certain speed is exceeded.

Additionally, it is configurable to unlock the driver's door or both doors after the ignition is switched off and the ignition key is removed.

Settings can be changed in the Info-Display.

Vehicle personalisation  102.

The settings can be saved for the key being used  23.

Doors

Load compartment

Tailgate

Opening



Press the brand emblem at the bottom half to unlock and open the tailgate.

Closing

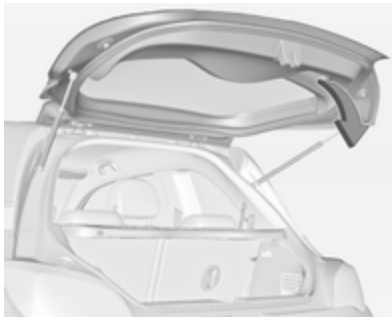

Use interior handle.

Do not press the emblem whilst closing as this will unlock the tailgate again.

Central locking system ⇨ 23.

General hints for operating tailgate

⚠ Danger

Do not drive with the tailgate open or ajar, e.g. when transporting bulky objects, since toxic exhaust

gases, which cannot be seen or smelled, could enter the vehicle. This can cause unconsciousness and even death.

Caution

Before opening the tailgate, check overhead obstructions, e.g. a garage door, to avoid damage to the tailgate. Always check the moving area above and behind the tailgate.

Note

The installation of certain heavy accessories onto the tailgate may affect its ability to remain open.

Vehicle security

Anti-theft locking system

⚠ Warning

Do not use the system if there are people in the vehicle! The doors cannot be unlocked from the inside.

The system deadlocks all the doors. All doors must be closed otherwise the system cannot be activated.

If the ignition was on, the driver's door must be opened and closed once so that the vehicle can be secured.

Unlocking the vehicle disables the mechanical anti-theft locking system. This is not possible with the central locking button in the passenger compartment.

Activating



Press  on the radio remote control twice within five seconds.



Anti-theft alarm system

The anti-theft alarm system is combined with the anti-theft locking system.

It monitors:

- doors, tailgate, bonnet
- ignition

Activation

- Self-activated 30 seconds after locking the vehicle by pressing  once.
- Directly by pressing  twice within five seconds.

Status LED



Status LED is integrated in the sensor on top of the instrument panel.

Status during the first 30 seconds of anti-theft alarm system activation:

LED illuminates : test, arming delay
 LED flashes : doors, tailgate or quickly bonnet not completely closed, or system fault

Status after system is armed:

LED flashes : system is armed slowly

Seek the assistance of a workshop in the event of faults.

Deactivation

Unlocking the vehicle by pressing  deactivates anti-theft alarm system.

The system is not deactivated by unlocking the driver's door with the key or with the central locking button in the passenger compartment.

Alarm

When triggered, the alarm horn sounds and the hazard warning lights flash simultaneously. The number and duration of alarm signals are stipulated by legislation.

The alarm can be silenced by pressing any button on the radio remote control or by switching on the ignition.

The anti-theft alarm system can only be deactivated by pressing  on the radio remote control or by switching on the ignition.

A triggered alarm, which has not been interrupted by the driver, will be indicated by the hazard warning lights. They will flash quickly three times when the vehicle is unlocked with the radio remote control.

Vehicle messages  99.

If the vehicle's battery is to be disconnected (e.g. for maintenance work), the alarm siren must be deactivated as follows: Switch the ignition on then off, then disconnect the vehicle's battery within 15 seconds.

Immobiliser

The system is part of the ignition switch and checks whether the vehicle is allowed to be started with the key being used.



The immobiliser is activated automatically after the key has been removed from the ignition switch.

If the control indicator  flashes when the ignition is on, there is a fault in the system; the engine cannot be started. Switch off the ignition and repeat the start attempt.

If the control indicator continues flashing, attempt to start the engine using the spare key and seek the assistance of a workshop.

Note

The immobiliser does not lock the doors. You should always lock the vehicle after leaving it.

Switch on the anti-theft alarm system  23,  27.

Control indicator   92.

Exterior mirrors

Convex shape

The convex exterior mirror contains an aspherical area and reduces blind spots. The shape of the mirror makes objects appear smaller, which will affect the ability to estimate distances.

Electric adjustment



Select the relevant exterior mirror by turning the control to left (L) or right (R). Then swivel the control to adjust the mirror.

In position 0 no mirror is selected.

Folding mirrors

For pedestrian safety, the exterior mirrors will swing out of their normal mounting position if they are struck with sufficient force. Reposition the mirror by applying slight pressure to the mirror housing.

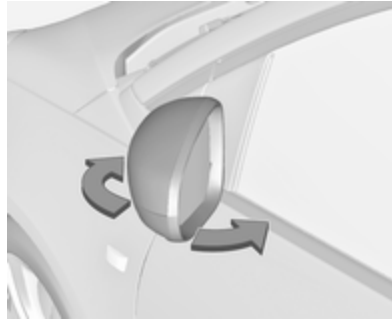

Parking position

The exterior mirrors can be folded in by pressing gently on the outer edge of the housing, e.g. when in a confined parking situation.

Heated mirrors



Operated by pressing .

Heating works with the engine running and is switched off automatically after a short time.

Interior mirrors

Manual anti-dazzle



To reduce dazzle, adjust the lever on the underside of the mirror housing to the front or rear. Lever in the middle position is the normal driving position.

Versions with illuminated starlight panel

When the starlight panel is illuminated, adjust the lever to the front. Starlight panel ⇨ 114.

Automatic anti-dazzle



Dazzle from following vehicles at night is automatically reduced.

Windows

Windscreen

Windscreen stickers

Do not attach stickers, e.g. toll road stickers or similar, on the windscreen in the area of the interior mirror. Otherwise the detection zone of the sensor in the mirror housing could be restricted.

Power windows

⚠ Warning

Take care when operating the power windows. Risk of injury, particularly to children.

Be careful when closing the windows. Ensure that nothing becomes trapped in them as they move.

Switch on ignition to operate power windows.

Retained power off ⇨ 129.



Operate the switch for the respective window by pushing to open or pulling to close.

Pushing or pulling gently to the first detent: window moves up or down as long as the switch is operated.

Pushing or pulling firmly to the second detent then releasing: window moves up or down automatically with safety function enabled. To stop movement, operate the switch once more in the same direction.

Safety function

If the window glass encounters resistance above the middle of the window during automatic closing, it is immediately stopped and opened again.

Override safety function

In the event of closing difficulties due to frost or the like, switch on the ignition, then pull the switch to the first detent and hold. The window moves up without safety function enabled. To stop movement, release the switch.

Operating windows from outside

The windows can be operated remotely from outside the vehicle.

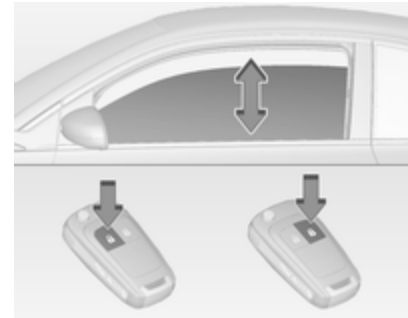

Press and hold  to open windows.

Press and hold  to close windows.

Release button to stop window movement.

If the windows are fully opened or closed, the hazard warning lights will flash twice.

Overload

If the windows are repeatedly operated within short intervals, the window operation is disabled for some time.

Initialising the power windows

If the windows cannot be closed automatically (e.g. after disconnecting the vehicle battery), a warning message or a warning code is displayed in the Driver Information Centre.

Vehicle messages ⇨ 99.

Activate the window electronics as follows:

1. Close the doors.
2. Switch on the ignition.
3. Pull switch until the window is closed and keep pulling for additional two seconds.
4. Repeat for each window.

Heated rear window



Operated by pressing .

Heating works with the engine running and is switched off automatically after a short time.

Sun visors

The sun visors can be folded down or swivelled to the side to prevent dazzling.

The cover of the mirrors should be closed when driving.

A ticket holder is located on the backside of the sun visor.

Roof

Sunroof

Foldable power sunroof

Warning

Take care when operating the sunroof. Risk of injury, particularly to children.

Keep a close watch on the movable parts when operating them. Ensure that nothing becomes trapped in them as they move.

Operable with ignition on (position 2)
⇨ 129.

The foldable power sunroof can be opened and closed while driving up to a speed of 140 km/h.

Retained power off ⇨ 129.





Switch can be operated in two ways: short press for automatic run and hold depressed for manual run.

Open

Short press on : sunroof opens automatically up to end position. To stop movement operate switch once more.

Hold  depressed: sunroof opens as long as switch is operated.

Close

Short press on : sunroof closes automatically up to a gap of approx. 30 cm for safety reasons. Following hold  depressed to close the

sunroof completely. To stop movement during automatic run operate switch once more.

Hold  depressed: sunroof closes as long as switch is operated.

Glass panel

Sunblind

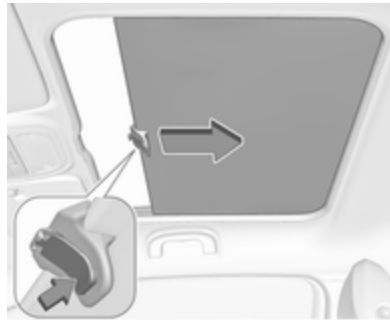

Press the button in the handle to open the sunblind and guide it backwards. It rolls up automatically.

No intermediate positions are possible.

To close, draw the sunblind to the front and allow the button to engage.

Seats, restraints

Head restraints	34
Front seats	35
Seat position	35
Seat adjustment	36
Seat folding	37
Heating	38
Seat belts	39
Three-point seat belt	40
Airbag system	41
Front airbag system	45
Side airbag system	45
Curtain airbag system	46
Airbag deactivation	46
Child restraints	48
Child restraint systems	48
Child restraint installation locations	50

Head restraints

Position

⚠ Warning

Only drive with the head restraint set to the proper position.

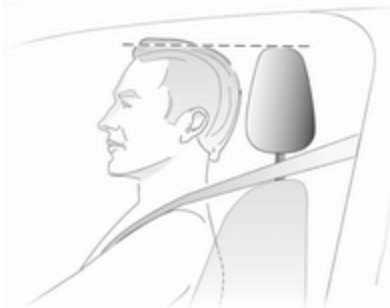

The upper edge of the head restraint should be at upper head level. If this is not possible for extremely tall people, set to highest position, and set to lowest position for small people.

Adjustment

Front head restraints, height adjustment



Press release button, adjust height, engage.

Rear head restraints, height adjustment

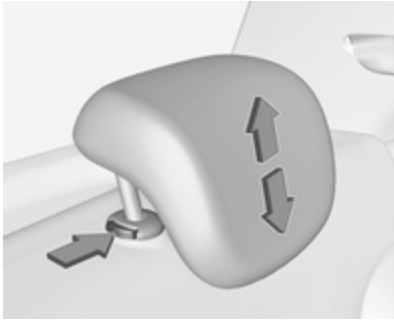

Pull the head restraint upwards and let engage. To move downwards, press the catch to release and push the head restraint downwards.

Removal of rear head restraint

E.g. when using a child restraint system ↪ 48.

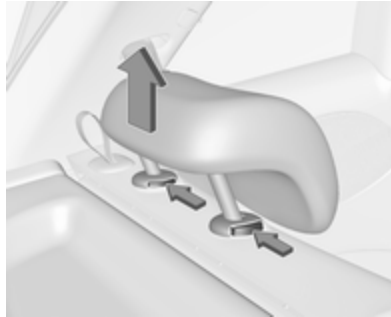

Press both catches, pull the head restraint upwards and remove.

Place the head restraint in a net bag and secure the underside of the bag with Velcro fasteners to the load compartment floor. A suitable net bag is available from your workshop.

Front seats

Seat position

⚠ Warning

Only drive with the seat correctly adjusted.

⚠ Danger

Do not sit closer than 25 cm to the steering wheel, to permit safe airbag deployment.

⚠ Warning

Never adjust seats while driving as they could move uncontrollably.

⚠ Warning

Never store any objects under the seats.



- Sit with buttocks as far back against the backrest as possible. Adjust the distance between the seat and the pedals so that legs are slightly angled when fully pressing the pedals. Slide the front passenger seat as far back as possible.
- Set seat height high enough to have a clear field of vision on all sides and of all display instruments. There should be at least one hand of clearance between head and the roof frame. Your thighs should rest lightly on the seat without pressing into it.

- Sit with shoulders as far back against the backrest as possible. Set the backrest rake so that it is possible to easily reach the steering wheel with arms slightly bent. Maintain contact between shoulders and the backrest when turning the steering wheel. Do not angle the backrest too far back. We recommend a maximum rake of approx. 25°.
- Adjust seat and steering wheel in a way that the wrist rests on top of the steering wheel while the arm is fully extended and shoulders on the backrest.
- Adjust the steering wheel ↻ 73.
- Adjust the head restraint ↻ 34.

Seat adjustment

Drive only with engaged seats and backrests.

Longitudinal adjustment



Pull handle, slide seat, release handle. Try to move the seat back and forth to ensure that the seat is locked in place.

Backrest inclination



Turn handwheel to adjust inclination.
Do not lean on backrest while adjusting.

Seat height

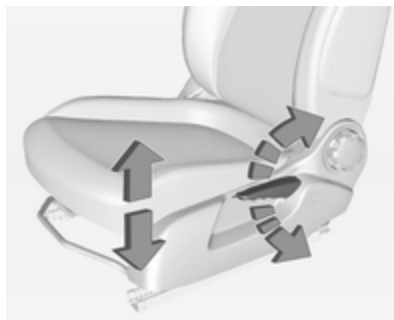

Lever pumping motion
up : seat higher
down : seat lower

Seat folding

Manual seats



Pull release lever towards the front and fold backrest forwards. Then slide seat forwards to the stop.

To restore, slide the seat backwards to the stop. Lift backrest to upright position without operating the release lever. Allow backrest to engage.

⚠ Warning

When folding up, ensure that the seat is securely locked in position before driving. Failure to do so may result in personal injury in the event of heavy braking or collision.

The memory function allows the seat to engage in its original position after folding.

Do not operate backrest adjuster handwheel when backrest is folded forwards.

Caution

When seat height is in the highest position, push head restraints down and fold up sun visors before folding backrest forwards.

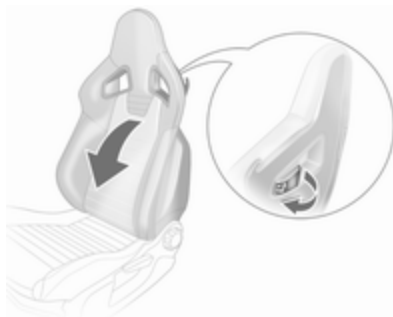
Sport seat folding

Remove seat belt from belt mount on the backrest.

Pull release lever located on the backrest, fold backrest forwards and release lever. Slide seat forwards to the stop.

To restore, slide the seat backwards to the stop. Lift backrest to upright position without operating the release lever. Allow backrest to engage.

⚠ Warning

When folding up, ensure that the seat is securely locked in position before driving. Failure to do so may result in personal injury in the event of heavy braking or collision.

The memory function allows the seat to engage in its original position after folding.

Do not operate backrest adjuster handwheel when backrest is folded forwards.

Heating

Activate seat heating by pressing  for the respective front seat.

Activation is indicated by the LED in the button.

Pressing  once more deactivates seat heating.

Seat heating is operational when engine is running.

During an Autostop seat heating is also operational.

Stop-start system ⇨ 131.

Seat belts



The seat belts are locked during heavy acceleration or deceleration of the vehicle, holding the occupants in the sitting position. Therefore the risk of injury is considerably reduced.

Warning

Fasten seat belt before each trip.
In the event of an accident, people not wearing seat belts endanger their fellow occupants and themselves.

Seat belts are designed to be used by only one person at a time. Child restraint system ⇨ 48.



Periodically check all parts of the belt system for damage, pollution and proper functionality.

Have damaged components replaced by a workshop. After an accident, have the belts and triggered belt pretensioners replaced by a workshop.

Note

Make sure that the belts are not damaged by shoes or sharp-edged objects or trapped. Prevent dirt from getting into the belt retractors.

Seat belt reminder

Each seat is equipped with a seat belt reminder, indicated for driver's seat by control indicator  in the tachometer ⇨ 87, for front passenger seat by control indicator  in the centre console ⇨ 85, and for rear seats by symbols  in the Driver Information Centre ⇨ 92.

Belt force limiters

On the front seats, stress on the body is reduced by the gradual release of the belt during a collision.

Belt pretensioners

In the event of a head-on or rear-end collision of a certain severity, the front seat belts are tightened.

⚠ Warning

Incorrect handling (e.g. removal or fitting of belts) can trigger the belt pretensioners.

Deployment of the belt pretensioners is indicated by continuous illumination of control indicator  ↻ 88.

Triggered belt pretensioners must be replaced by a workshop. Belt pretensioners can only be triggered once.

Note

Do not affix or install accessories or other objects that may interfere with the operation of the belt pretensioners. Do not make any

modifications to belt pretensioner components as this will invalidate the operating permit of your vehicle.

Three-point seat belt

Fasten



Withdraw the belt from the retractor, guide it untwisted across the body and insert the latch plate into the buckle. Tighten the lap belt regularly while driving by pulling the shoulder belt.

Sport seat: Feed seat belt through belt mount on backrest when fastening seat belt.



30053

Loose or bulky clothing prevents the belt from fitting snugly. Do not place objects such as handbags or mobile phones between the belt and your body.

⚠ Warning

The belt must not rest against hard or fragile objects in the pockets of your clothing.

Seat belt reminder  ↻ 87.

Unfasten



To release belt, press red button on belt buckle.

Using the seat belt while pregnant



⚠ Warning

The lap belt must be positioned as low as possible across the pelvis to prevent pressure on the abdomen.

Airbag system

The airbag system consists of a number of individual systems depending on the scope of equipment.

When triggered, the airbags inflate within milliseconds. They also deflate so quickly that it is often unnoticeable during the collision.

⚠ Warning

The airbag system deploys in an explosive manner, repairs must be performed by skilled personnel only.

⚠ Warning

Adding accessories that change the vehicle's frame, bumper system, height, front end or side sheet metal, may keep the airbag system from working properly. The operation of the airbag system can also be affected by changing any parts of the front seats, seat belts,

airbag sensing and diagnostic module, steering wheel, instrument panel, inner door seals including the speakers, any of the airbag modules, ceiling or pillar trim, front sensors, side impact sensors or airbag wiring.

Note

The airbag systems and belt pretensioner control electronics are located in the centre console area. Do not put any magnetic objects in this area.

Do not affix any objects onto the airbag covers and do not cover them with other materials. Have damaged covers replaced by a workshop.

Each airbag is triggered only once. Have deployed airbags replaced by a workshop. Furthermore, it may be necessary to have the steering wheel, the instrument panel, parts of the panelling, the door seals, handles and the seats replaced.

Do not make any modifications to the airbag system as this will invalidate the vehicle operating permit.

Fault

If there is a fault in the airbag system, control indicator  illuminates and a message or a warning code appears in the Driver Information Centre. The system is not operational.

Have the cause of the fault remedied by a workshop.

Control indicator for airbag systems
 88.

Child restraint systems on front passenger seat with airbag systems

Warning according to ECE R94.02:



EN: NEVER use a rearward-facing child restraint on a seat protected by an ACTIVE AIRBAG in front of it; DEATH or SERIOUS INJURY to the CHILD can occur.

DE: Nach hinten gerichtete Kindersitze NIEMALS auf einem Sitz verwenden, der durch einen davor befindlichen AKTIVEN AIRBAG geschützt ist, da dies den TOD oder SCHWERE VERLETZUNGEN DES KINDES zur Folge haben kann.

FR: NE JAMAIS utiliser un siège d'enfant orienté vers l'arrière sur un siège protégé par un COUSSIN GONFLABLE ACTIF placé devant lui, sous peine d'infliger des BLESSURES GRAVES, voire MORTELLES à l'ENFANT.

ES: NUNCA utilice un sistema de retención infantil orientado hacia atrás en un asiento protegido por un AIRBAG FRONTAL ACTIVO. Peligro de MUERTE o LESIONES GRAVES para el NIÑO.

RU: ЗАПРЕЩАЕТСЯ устанавливать детское удерживающее устройство лицом назад на сиденье автомобиля,

оборудованном фронтальной подушкой безопасности, если ПОДУШКА НЕ ОТКЛЮЧЕНА! Это может привести к СМЕРТИ или СЕРЬЕЗНЫМ ТРАВМАМ РЕБЕНКА.

NL: Gebruik NOOIT een achterwaarts gericht kinderzitje op een stoel met een ACTIEVE AIRBAG ervoor, om DODELIJK of ERNSTIG LETSEL van het KIND te voorkomen.

DA: Brug ALDRIG en bagudvendt autostol på et forsæde med AKTIV AIRBAG, BARNET kan komme i LIVSFARE eller komme ALVORLIGT TIL SKADE.

SV: Använd ALDRIG en bakåtvänd barnstol på ett säte som skyddas med en framförvarande AKTIV AIRBAG. DÖDSFALL eller ALLVARLIGA SKADOR kan drabba BARNET.

FI: ÄLÄ KOSKAAN sijoita taaksepäin suunnattua lasten turvaistuinta istuimelle, jonka edessä on AKTIIVINEN TURVATYYNY, LAPSI VOI KUOLLA tai VAMMAUTUA VAKAVASTI.

NO: Bakovervendt barnesikringsutstyr må ALDRI brukes på et sete med AKTIV KOLLISJONSPUTE foran, da det kan føre til at BARNET utsettes for LIVSFARE og fare for ALVORLIGE SKADER.

PT: NUNCA use um sistema de retenção para crianças voltado para trás num banco protegido com um AIRBAG ACTIVO na frente do mesmo, poderá ocorrer a PERDA DE VIDA ou FERIMENTOS GRAVES na CRIANÇA.

IT: Non usare mai un sistema di sicurezza per bambini rivolto all'indietro su un sedile protetto da AIRBAG ATTIVO di fronte ad esso: pericolo di MORTE o LESIONI GRAVI per il BAMBINO!

EL: ΠΟΤΕ μη χρησιμοποιείτε παιδικό κάθισμα ασφαλείας με φορά προς τα πίσω σε κάθισμα που προστατεύεται από μετωπικό ΕΝΕΡΓΟ ΑΕΡΟΣΑΚΟ, διότι το παιδί μπορεί να υποστεί ΤΡΑΥΜΑΤΙΣΜΟ.

PL: NIE WOLNO montować fotelika dziecięcego zwróconego tyłem do kierunku jazdy na fotelu, przed którym znajduje się WŁĄCZONA PODUSZKA POWIETRZNA. Niezastosowanie się do tego zalecenia może być przyczyną ŚMIERCI lub POWAŻNYCH OBRAŻEŃ u DZIECKA.

TR: Arkaya bakan bir çocuk emniyet sistemini KESİNLİKLE önünde bir AKTİF HAVA YASTIĞI ile korumakta olan bir koltukta kullanmayınız. ÇOCUK ÖLEBİLİR veya AĞIR ŞEKİLDE YARALANABİLİR.

UK: НІКОЛИ не використовуйте систему безпеки для дітей, що встановлюється обличчям назад, на сидінні з УВІМКНЕНОЮ ПОДУШКОЮ БЕЗПЕКИ, інакше це може призвести до СМЕРТІ чи СЕРІОЗНОГО ТРАВМУВАННЯ ДИТИНИ.

HU: SOHA ne használjon hátrafelé néző biztonsági gyermekülést előlről AKTÍV LÉGZSÁKKAL védett ülésen, mert a GYERMEK HALÁLÁT vagy KOMOLY SÉRÜLÉSÉT okozhatja.

HR: NIKADA nemojte koristiti sustav zadržavanja za djecu okrenut prema natrag na sjedalu s AKTIVNIM ZRAČNIM JASTUKOM ispred njega, to bi moglo dovesti do SMRTI ili OZBILJNIH OZLJEDA za DIJETE.

SL: NIKOLI ne nameščajte otroškega varnostnega sedeža, obrnjenega v nasprotni smeri vožnje, na sedež z AKTIVNO ČELNO ZRAČNO BLAZINO, saj pri tem obstaja nevarnost RESNIH ali SMRTNIH POŠKODB za OTROKA.

SR: NIKADA ne koristiti bezbednosni sistem za decu u kome su deca okrenuta unazad na sedištu sa AKTIVNIM VAZDUŠNIM JASTUKOM ispred sedišta zato što DETE može da NASTRADA ili da se TEŠKO POVREDI.

MK: НИКОГАШ не користете детско седиште свртено наназад на седиште заштитено со АКТИВНО ВОЗДУШНО ПЕРНИЧЕ пред него, затоа што детето може ДА ЗАГИНЕ или да биде ТЕШКО ПОВРЕДЕНО.

BG: НИКОГА не използвайте детска седалка, гледаща назад, върху седалка, която е защитена

чрез АКТИВНА ВЪЗДУШНА ВЪЗГЛАВНИЦА пред нея - може да се стигне до СМЪРТ или СЕРИОЗНО НАРАНЯВАНЕ на ДЕТЕТО.

RO: Nu utilizați NICIODATĂ un scaun pentru copil îndreptat spre partea din spate a mașinii pe un scaun protejat de un AIRBAG ACTIV în fața sa; acest lucru poate duce la DECESUL sau VĂTĂMAREA GRAVĂ a COPILULUI.

CS: NIKDY nepoužívejte dětský zadržný systém instalovaný proti směru jízdy na sedadle, které je chráněno před sedadlem AKTIVNÍM AIRBAGEM. Mohlo by dojít k VÁŽNĚMU PORANĚNÍ nebo ÚMRTÍ DÍTĚTE.

SK: NIKDY nepoužívajte detskú sedačku otočenú vzad na sedadle chránenom AKTÍVNÝM AIRBAGOM, pretože môže dôjsť k SMRTI alebo VÁŽNÝM ZRANENIAM DIEŤAŤA.

LT: JOKIU BŪDU nemontuokite atgal atgręžtos vaiko tvirtinimo sistemas sėdynėje, prieš kurią įrengta AKTYVI ORO PAGALVĖ, nes VAIKAS GALI ŽŪTI arba RIMTAI SUSIŽALOTI.

LV: NEKĀDĀ GADĪJUMĀ neizmantojiet uz aizmuguri vērstu bērnu sēdekļīti sēdvietā, kas tiek aizsargāta ar tās priekšā uzstādītu AKTĪVU DROŠĪBAS SPILVENU, jo pretējā gadījumā BĒRNS var gūt SMAGAS TRAUMAS vai IET BOJĀ.

ET: ÄRGE kasutage tahapoole suunatud lapseturvaistet istmel, mille ees on AKTIIVSE TURVAPADJAGA kaitstud iste, sest see võib põhjustada LAPSE SURMA või TÕSISE VIGASTUSE.

MT: QATT tuża trażżin għat-tfal li jħares lejn in-naħa ta' wara fuq sit protett b'AIRBAG ATTIV quddiemu; dan jista' jikkawża l-MEWT jew ĠRIEHI SERJI lit-TFAL.

GA: Ná húsáid srian sábháilteachta linbh cúil RIAMH ar shuíochán a bhfuil mála aeir ag feidhmiú os a chomhair. Tá baol BÁIS nó GORTÚ DONA don PHÁISTE ag baint leis.

Beyond the warning required by ECE R94.02, for safety reasons a forward-facing child restraint system must only be used subject to the instructions and restrictions in the table ⇨ 50.

The airbag label is located on both sides of the front passenger sun visor.
Airbag deactivation ⇨ 46.

Front airbag system

The front airbag system consists of one airbag in the steering wheel and one in the instrument panel on the front passenger side. The location is identified by the word **AIRBAG**.

The front airbag system is triggered in the event of a front-end impact of a certain severity. The ignition must be switched on.

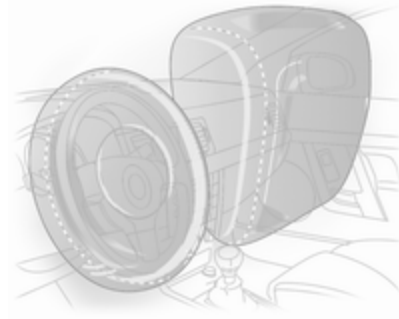

The inflated airbags cushion the impact, thereby reducing the risk of injury to the upper body and head of the front seat occupants considerably.

⚠ Warning

Optimum protection is only provided when the seat is in the proper position.

Seat position ⇨ 35.

Keep the area in which the airbag inflates clear of obstructions.

Fit the seat belt correctly and engage securely. Only then is the airbag able to protect.

Side airbag system



The side airbag system consists of an airbag in each front seat backrest. The location is identified by the word **AIRBAG**.

The side airbag system is triggered in the event of a side impact of a certain severity. The ignition must be switched on.

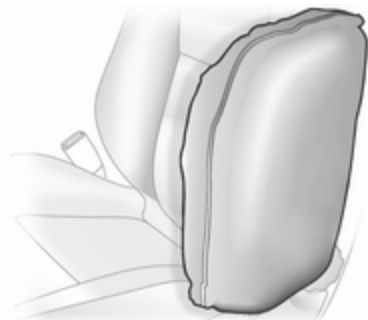

The inflated airbags cushion the impact, thereby reducing the risk of injury to the upper body and pelvis in the event of a side-on collision considerably.

⚠ Warning

Keep the area in which the airbag inflates clear of obstructions.

Note

Only use protective seat covers that have been approved for the vehicle. Be careful not to cover the airbags.

Curtain airbag system

The curtain airbag system consists of an airbag in the roof frame on each side. The location is identified by the word **AIRBAG** on the roof pillars.

The curtain airbag system is triggered in the event of a side-on impact of a certain severity. The ignition must be switched on.

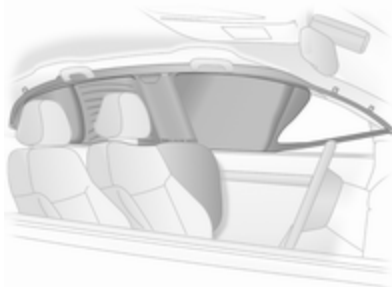

The inflated airbags cushion the impact, thereby reducing the risk of injury to the head in the event of a side-on impact considerably.

⚠ Warning

Keep the area in which the airbag inflates clear of obstructions.

The hooks on the handles in the roof frame are only suitable for hanging up light articles of clothing, without coat hangers. Do not keep any items in these clothes.



Airbag deactivation

The front passenger airbag system must be deactivated for child restraint system on the passenger seat according to the instructions in the table ↪ 50. The side airbag and curtain airbag systems, the belt pretensioners and all driver airbag systems will remain active.



The front passenger airbag system can be deactivated via a key-operated switch on the passenger side of the instrument panel.

Use the ignition key to choose the switch position:

-  OFF : front passenger airbag is deactivated and will not inflate in the event of a collision. Control indicator  OFF illuminates continuously in the centre console
-  ON : front passenger airbag is active

Danger

Deactivate passenger airbag only in combination with the use of a child restraint system, subject to the instructions and restrictions in the table ⇨ 50.

Otherwise, there is a risk of fatal injury for a person occupying a seat with a deactivated front passenger airbag.



If the control indicator  illuminates for approx. 60 seconds after the ignition is switched on, the front passenger airbag system will inflate in the event of a collision.

If both control indicators are illuminated at the same time, there is a system failure. The status of the system is not discernible, therefore no person is allowed to occupy the front passenger seat. Contact a workshop immediately.

Change status only when the vehicle is stopped with the ignition off.

Status remains until the next change.

Control indicator for airbag deactivation ⇨ 88.

Child restraints

Child restraint systems

⚠ Danger

If using a rear-facing child restraint system on the front passenger seat, the airbag system for the front passenger seat must be deactivated. This also applies to certain forward-facing child restraint systems as indicated in the table ⇨ 50.

Airbag deactivation ⇨ 46.

Airbag label ⇨ 41.

We recommend a child restraint system which is tailored specifically to the vehicle. For further information, contact your workshop.

When a child restraint system is being used, pay attention to the following usage and installation instructions and also those supplied with the child restraint system.

Always comply with local or national regulations. In some countries, the use of child restraint systems is forbidden on certain seats.

Child restraint systems can be fastened with:

- Three-point seat belt
- ISOFIX brackets
- Top-tether anchors

Three-point seat belt

Child restraint systems can be fastened by using a three-point seat belt ⇨ 50.

ISOFIX brackets

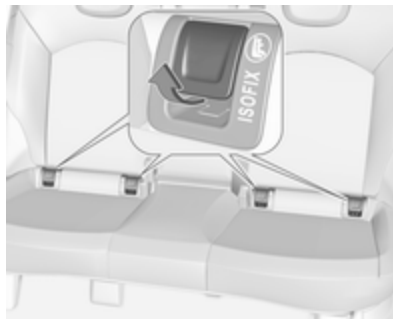

Fasten vehicle-approved ISOFIX child restraint systems to the ISOFIX mounting brackets. Specific vehicle ISOFIX child restraint system positions are marked in the table by IL ⇨ 50.

The vehicle is equipped with guides in the backrests to support the installation of the child restraint system.

ISOFIX mounting brackets are indicated by the ISOFIX logo on the backrest.

Open the flaps of the guides before mounting a child restraint system. After removing the child restraint system, close the flaps.

Top-tether anchors

Top-tether anchors are marked with the symbol 🚫 for a child seat.

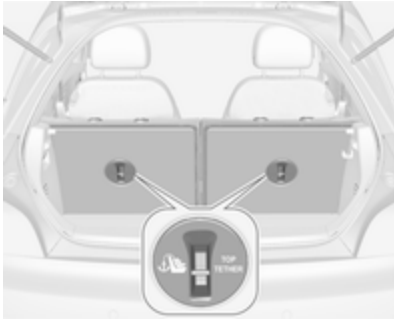

In addition to the ISOFIX mounting brackets, fasten the Top-tether strap to the Top-tether anchors.

ISOFIX child restraint systems of universal category positions are marked in the table by IUF ⇨ 50.

Selecting the right system

The rear seats are the most convenient location to fasten a child restraint system.

Children should travel facing rearwards in the vehicle as long as possible. This ensures that the child's

backbone, which is still very weak, is under less strain in the event of an accident.

Suitable are restraint systems that comply with valid UN ECE regulations. Check local laws and regulations for mandatory use of child restraint systems.

Ensure that the child restraint system to be installed is compatible with the vehicle type.

Refer to the tables on the following pages, the instructions supplied with the child restraint system and the vehicle type list of non-universal child restraint systems.

The following child restraints are recommended for the following weight classes:

- **Group 0, Group 0+**
OPEL Baby cradle, with or without **ISOFIX** base, for children up to 13 kg.
- **Group I**
FAIR G 0/1 S **ISOFIX**, for children from 9 kg to 13 kg in this group.

OPEL Duo, for children from 13 kg to 18 kg in this group.

- **Group II, Group III**

OPEL Kid, OPEL Kidfix, TAKATA MAXI 2/3 for children from 15 kg up to 36 kg.

Ensure that the mounting location of the child restraint system within the vehicle is correct, see following tables.

Allow children to enter and exit the vehicle only on the side facing away from the traffic.

When the child restraint system is not in use, secure the seat with a seat belt or remove it from the vehicle.

Note

Do not affix anything on the child restraint systems and do not cover them with any other materials.

A child restraint system which has been subjected to stress in an accident must be replaced.

Child restraint installation locations

Permissible options for fitting a child restraint system

Weight class	On front passenger seat		On rear seats
	activated airbag	deactivated airbag	
Group 0: up to 10 kg	X	U ¹	U*
Group 0+: up to 13 kg	X	U ¹	U*
Group I: 9 to 18 kg	X	U ¹	U ² *
Group II: 15 to 25 kg	U **	X	U *
Group III: 22 to 36 kg	U **	X	U *

¹ : if the child restraint system is being secured using a three-point seat belt, adjust seat backrest to a vertical position to ensure that the belt is tight on the buckle side. Move seat height to the uppermost position.

² : remove rear head restraint when using child restraint systems in this group ⇨ 34

* : move the respective front seat ahead of the child restraint system to one of the foremost adjustment positions

** : move the front passenger seat to the rearmost adjustment position. Move seat height to the uppermost position and the headrest to the lowest position. Adjust seat backrest as far as necessary to a vertical position to ensure that vehicle seat belt runs forwards from the upper anchorage point

U : universal suitability in conjunction with three-point seat belt

X : no child restraint system permitted in this weight class

Permissible options for fitting an ISOFIX child restraint system

Weight class	Size class	Fixture	On front passenger seat	On rear seats
Group 0: up to 10 kg	E	ISO/R1	X	IL *
Group 0+: up to 13 kg	E	ISO/R1	X	IL *
	D	ISO/R2	X	X
	C	ISO/R3	X	X
Group I: 9 to 18 kg	D	ISO/R2	X	X
	C	ISO/R3	X	X
	B	ISO/F2	X	IL, IUF**
	B1	ISO/F2X	X	IL, IUF**
	A	ISO/F3	X	IL, IUF**
Group II: 15 to 25 kg			X	IL
Group III: 22 to 36 kg			X	IL

IL : suitable for particular ISOFIX restraint systems of the "specific-vehicle", "restricted" or "semi-universal" categories.

The ISOFIX restraint system must be approved for the specific vehicle type

IUF : suitable for ISOFIX forward-facing child restraint systems of universal category approved for use in this weight class

X : no ISOFIX child restraint system approved in this weight class

* : move the respective front seat ahead of the child restraint system to one of the foremost adjustment positions

** : remove respective rear head restraint when using child restraint systems in this size class ⇨ 34

ISOFIX size class and seat device

- A – ISO/F3 : forward-facing child restraint system for children of maximum size in the weight class 9 to 18 kg
- B – ISO/F2 : forward-facing child restraint system for smaller children in the weight class 9 to 18 kg
- B1 – ISO/F2X : forward-facing child restraint system for smaller children in the weight class 9 to 18 kg
- C – ISO/R3 : rear-facing child restraint system for children of maximum size in the weight class up to 18 kg
- D – ISO/R2 : rear-facing child restraint system for smaller children in the weight class up to 18 kg
- E – ISO/R1 : rear-facing child restraint system for young children in the weight class up to 13 kg

Storage

Storage compartments	53
Glovebox	53
Cupholders	53
Front storage	54
Rear carrier system	55
Load compartment	64
Rear storage	65
Load compartment cover	66
Rear floor storage cover	67
Lashing eyes	68
Warning triangle	68
First aid kit	69
Roof rack system	69
Roof rack	69
Loading information	70

Storage compartments

⚠ Warning

Do not store heavy or sharp objects in the storage compartments. Otherwise, the storage compartment lid could open and vehicle occupants could be injured by objects being thrown around in the event of hard braking, a sudden change in direction or an accident.

Glovebox



Pull lever to open the glovebox cover. The glovebox features a coin holder and an adapter for the locking wheel bolts.

The glovebox should be closed whilst driving.

Cupholders

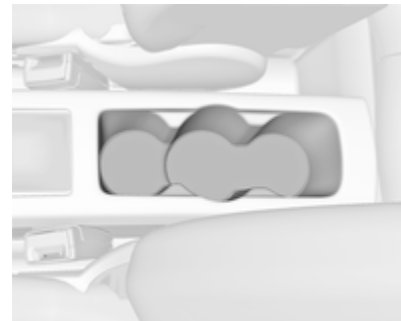

Cupholders are located in the console between the front seats. They are designed for cups of different sizes.



Door pockets in both doors are designed to carry bottles.

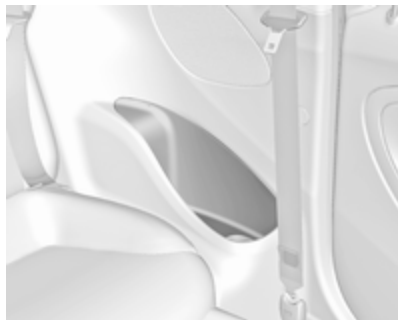

Additional cupholders or bottle holders are located in the rear side panels.

Flexible cupholder strap



A movable rubber strap is located in the storage compartment in front of the gear selector lever. Pull out the strap to fix a cup or ashtray.

Front storage

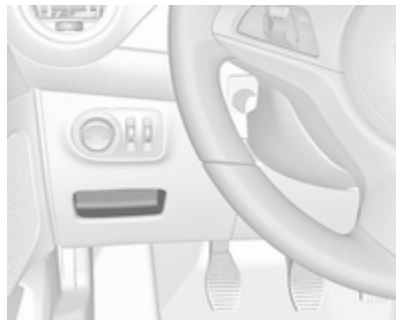

Storage compartments are located below the light switch, in the centre console in front of the gear selector lever, in the door pockets and in the side panels near the rear seats.

Rear carrier system

Rear carrier system for two bicycles



The rear carrier system (Flex-Fix system) allows one bicycle to be attached to an extendable carrier integrated into the vehicle floor. It is possible to attach one further bicycle on an adapter. The transportation of other objects is not permitted.

The maximum load of the rear carrier system is 50 kg with attached adapter and 30 kg without attached adapter. This allows the attachment of an

electrically-powered bicycle to the rear carrier system. The maximum load on the adapter is 20 kg.

The wheelbase of a bicycle must not exceed 1.15 metres. Otherwise the secure fastening of a bicycle is not possible.

If not in use, the rear carrier system must be slid back into the vehicle floor.

There must not be any objects on the bicycles that could become loose during transportation.

Caution

If the rear carrier system is extended and the vehicle is fully loaded, the chassis clearance will be reduced.

Drive carefully whenever the road has a strong inclination or when driving over a ramp, bump, etc.

Caution

Consult your bicycle dealer before attaching bicycles with carbon frames. The bicycles might get damaged.

Note

The tail lights of the vehicle will be deactivated if the tail lights of the rear carrier system are installed.

Extending

Open the tailgate.

⚠ Warning

No-one should be in the extension zone of the rear carrier system, risk of injury.

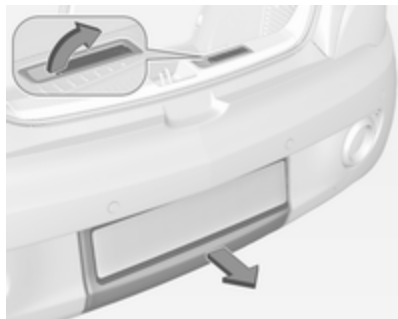

Pull release lever up. The system disengages and travels quickly out of the bumper.

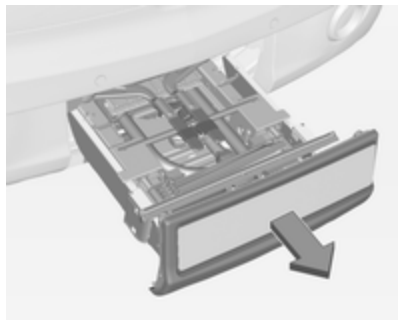

Completely pull out the rear carrier system until you hear it engage. Ensure that it is not possible to push in the rear carrier system without pulling the release lever again.

⚠ Warning

It is only permissible to fit objects to the rear carrier system if the system has been correctly engaged. If the rear carrier system will not engage correctly, do not fit objects to the system and slide the system back. Seek the assistance of a workshop.

Unfold number plate light

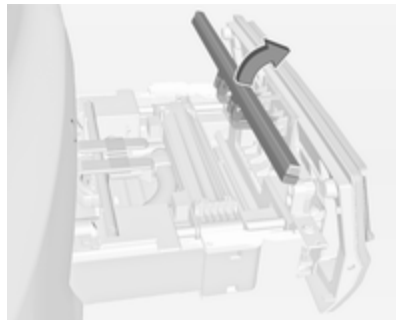

Lift the number plate light and fold it backwards.

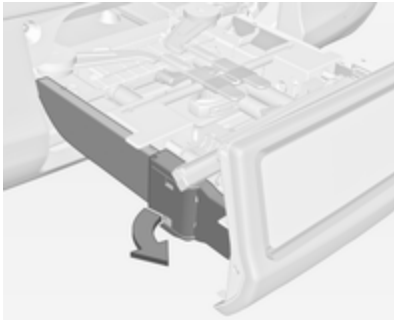
Fold out tail lamps

Swivel hinges of both tail lamps backwards as far as they will go.

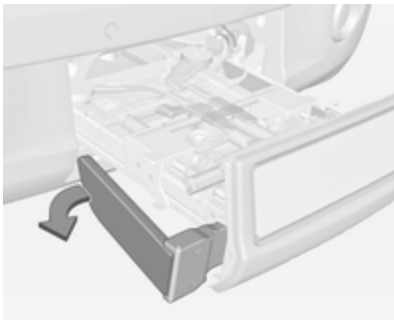

Swivel both tail lamps backwards as far as they will go.

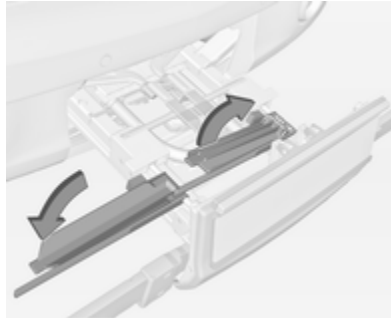
Fold out wheel recess

Remove strap and fold out the wheel recess.

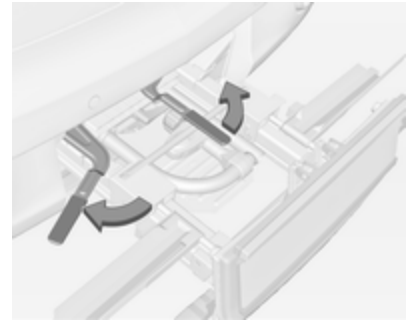
Lock the rear carrier system

Remove strap and swivel both clamping levers sideways as far as they will go.

Otherwise safe functionality is not guaranteed.

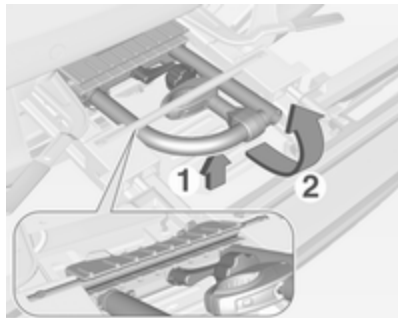
Assembling the bicycle rack

Lift the rack at the rear (1) and pull it backwards.

Fold up the rack (2).

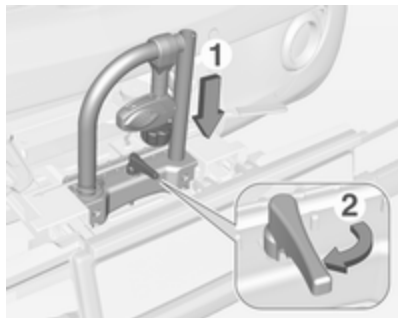

Push down the rack (1) and turn handle (2) backwards to engage.

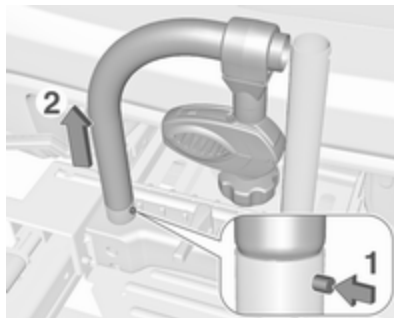

Press button (1) and remove left part of rack (2).

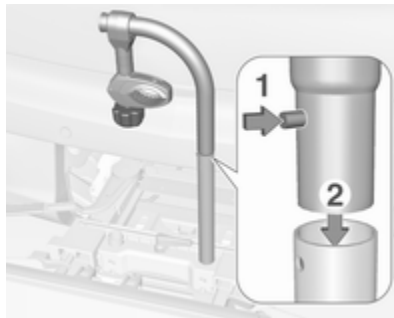

Press button (1) and insert left part of rack into the right part (2).

Attaching the adapter

When carrying two bicycles, the adapter must be fixed before attaching the first bicycle.

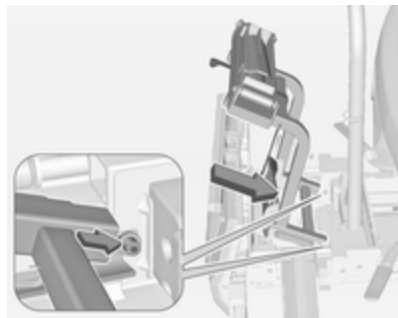

1. Install the adapter to the rear carrier system as shown in the illustration.

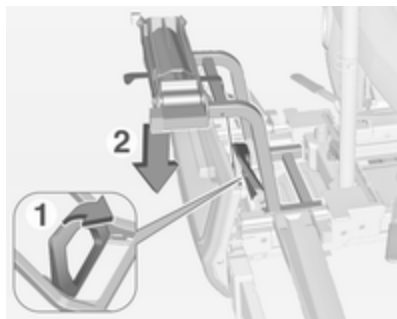

2. Turn the lever (1) forwards and hold, then lower the adapter (2) at the rear.
3. Release lever and check that the adapter is engaged securely.

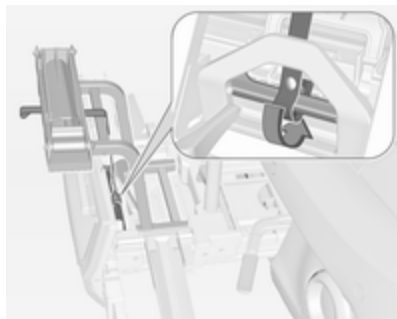

4. Guide the strap attached to the adapter underneath the lever for folding back the rear carrier system. Fasten the strap.

Attaching the first bicycle



1. Rotate the pedals into position as shown in the illustration and put the bicycle on the wheel recess. Make sure that the bicycle stands centrally on the wheel recesses.

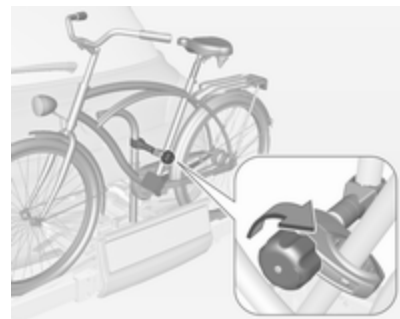

2. Attach the short mounting bracket to the bicycle frame. Turn the knob clockwise to fasten.

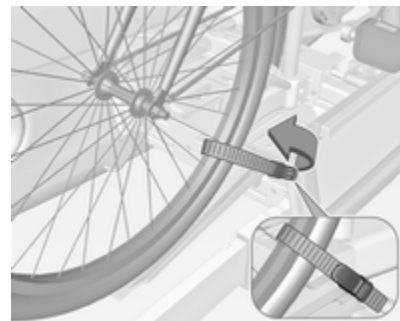

- Secure both bicycle wheels to the wheel recesses using the strap retainers.
- Check the bicycle to make sure it is secure.

Caution

Ensure gap between bicycle and vehicle is at least 5 cm. If necessary, loosen handlebar and swivel sideways.

Attaching the second bicycle

The attachment of a second bicycle is similar to the attachment of the first bicycle. Additionally, some steps must be considered:

- Always rotate the pedals into an appropriate position before putting on the bicycle.

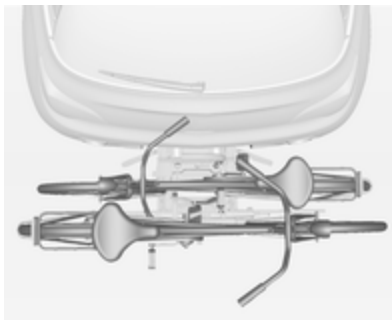

- Position the bicycles on the rear carrier system alternately aligned to the left and to the right.
- Align the rear bicycle to the front bicycle. The wheel hubs of the bicycles must not touch each other.
- Attach the rear bicycle with the longer mounting bracket and the strap retainers as described for the front bicycle. The mounting brackets should be fixed in parallel.

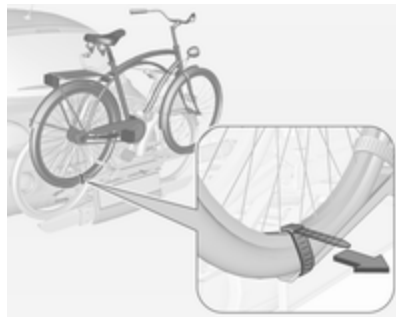

- Additionally, secure both bicycle wheels of the rear bicycle to the wheel recesses using the tensioning straps.

It is recommended to attach a warning sign at the rearmost bicycle, to increase visibility.

Fold the rear carrier system backwards

The rear carrier system can be folded backwards to gain access to the load compartment.

- Without attached adapter:

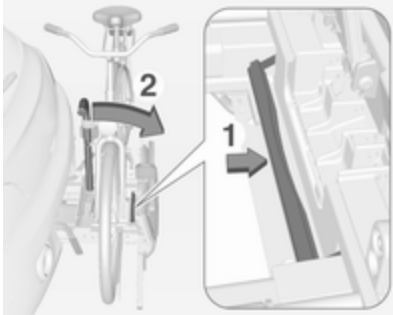

Push the lever (1) to disengage and hold.

Pull the rack (2) backwards to fold the rear carrier system.

- With attached adapter:

⚠ Warning

Take care when disengaging the rear carrier system as it will tilt backwards. Risk of injury.

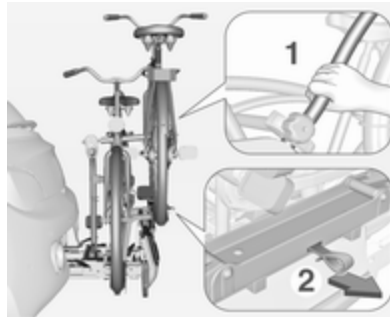

Hold frame (1) of rear bicycle with one hand and pull the loop (2) to disengage.

Hold rear bicycle with both hands and fold the rear carrier system backwards.

To increase visibility, the tail lights of the vehicle are activated when the rear carrier system is folded back.

⚠ Warning

When folding the rear carrier system forwards again, take care that the system is engaged securely.

Removing bicycles

Undo strap retainers on both bicycle tyres.

Turn knob anticlockwise and remove mounting brackets.

Detaching adapter

1. Fold in wheel recesses.

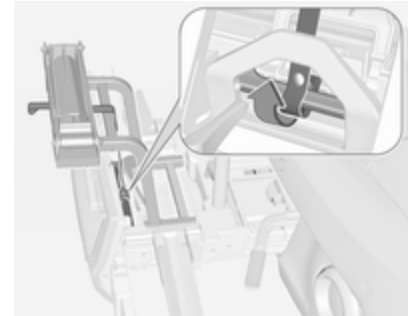

2. Unbutton the strap.

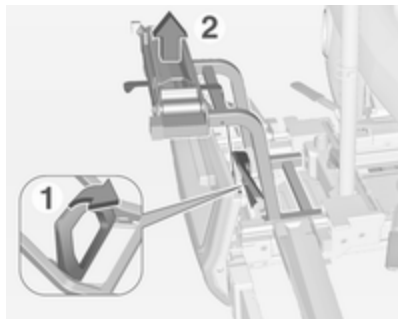

3. Turn the lever (1) forwards and hold.
4. Lift the adapter (2) at the rear and remove.

Disassembling the bicycle rack

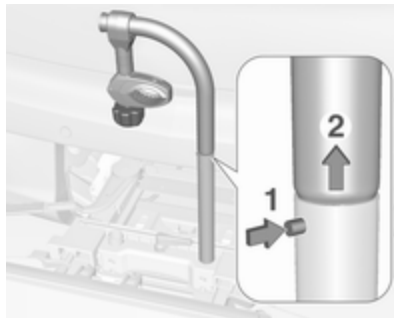

Press button (1) and remove upper part of rack (2).

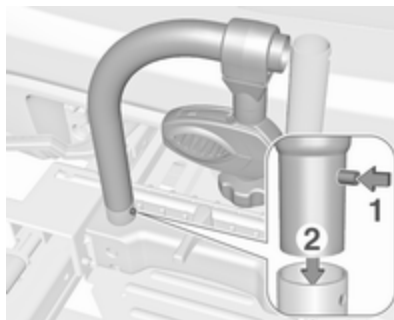

Press button (1) and reinstall rack (2).

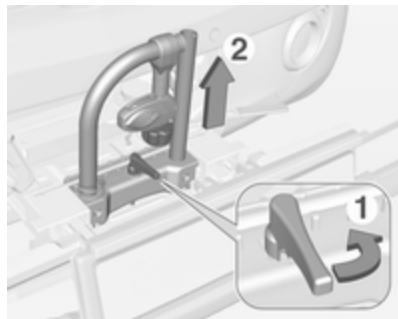

Arrange mounting bracket as shown in the illustration.

Turn handle (1) sideways to disengage and lift the rack (2).

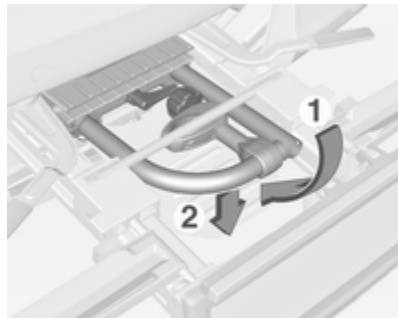

Fold the rack backwards, then push forwards until it stops (1).

Press the rack down at the rear (2).

Fold in wheel recess

Fold in wheel recess. Fasten strap.

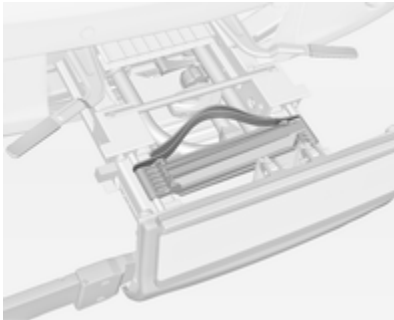

Stow the strap retainers accurately.

Unlock the rear carrier system

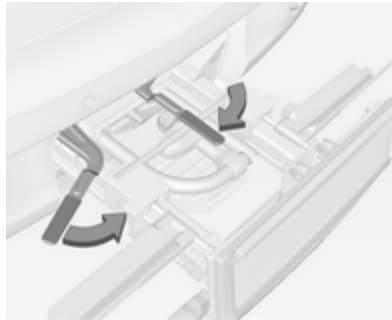

Swivel both clamping levers inwards as far as they will go. Fasten strap.

Fold in tail lamps

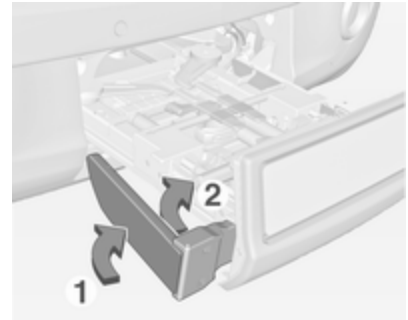

First swivel tail lamps (1) forwards as far as they will go.

Then swivel hinges (2) forwards as far as they will go.

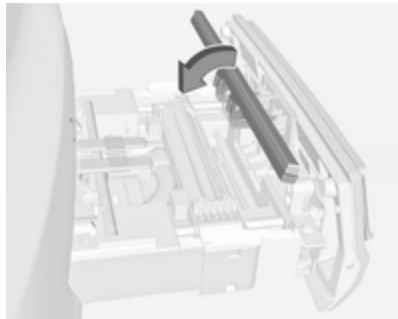
Fold in number plate light

Fold number plate light forwards.

Retracting the rear carrier system**Caution**

Take care that all foldable parts, e.g. wheel recesses and mounting brackets, are stowed accurately. Otherwise the rear carrier system might get damaged when trying to retract it.



Push the release lever up and hold. Lift the system slightly and push it into the bumper until it engages.

Release lever must return to original position.

Warning

If the system cannot be correctly engaged, please seek the assistance of a workshop.

Load compartment

The rear seat backrest is divided into two parts. Both parts can be folded down separately.

Load compartment extension

Remove the load compartment cover if necessary.

Press the catch and push down the head restraint.



Insert seat belt latch plate into side holder to protect the belt against damage.

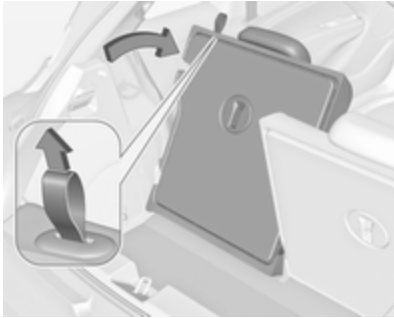

Pull the loop on one or both backrests and fold them down onto the seat cushion.

To fold up, raise the backrests into upright position and let them engage audibly.

The backrests are properly engaged when the red marks on both release loops are not visible.

⚠ Warning

When folding up, ensure that backrests are securely locked in position before driving. Failure to

do so may result in personal injury or damage to load or vehicle in the event of heavy braking or collision.

Hook for carrier bags



Use the hook at the right sidewall of the load compartment for hanging up carrier bags. Maximum load: 5 kg.

Rear storage

Storage box

A closable storage box is located in the load compartment. The cover is lockable by turning the knob. It must be locked while driving.

To open, unlock and lift up the cover.

To remove the cover, open it and slide sideways to the left.

The box can be separated by a divider.

The storage box cover can be loaded with max. 20 kg.

Removal

To gain access to emergency breakdown equipment or for bulb replacement of the tail lights, the storage box must be removed:

- Remove the load compartment cover ⇨ 66.
- Fold down the rear backrests ⇨ 64.
- Open the storage box.



- Turn the lock hooks on both sides to the rear and push down the lashing eyes in the recesses.
- Raise the storage box and place it on the folded backrests.
- Remove the storage box out of the load compartment.

Installation

- Place the storage box on the folded backrests.
- Lower the box in the load compartment.
- Open the storage box.

- Raise the lashing eyes on both sides and turn the lock hooks to the front to fix the box to the lashing eyes.
- Raise the rear backrests and install the load compartment cover.
- Stow the suitcase with tyre repair kit in a chamber of the storage box.
- Close and lock the cover.

Load compartment cover

Do not place any objects on the cover.

Opening

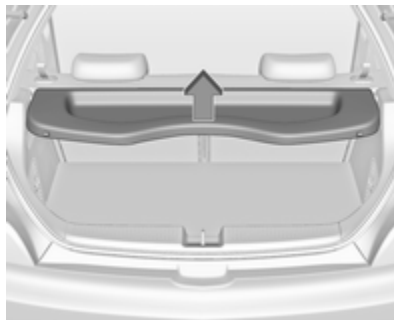

Lift up the cover at the rear end. It engages in a nearly vertical position. Further opening is possible. To close, move down the cover beyond the engage point.

Removing

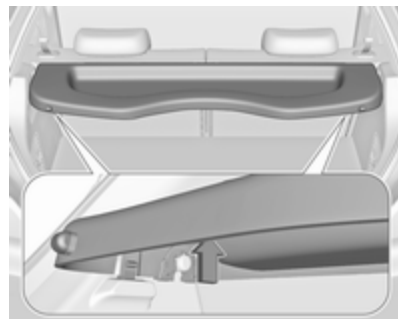

Push cover upwards at the left and right from the lower side and remove.

Fitting

Engage cover by pushing into guides on both sides.

Rear floor storage cover

Rear floor cover

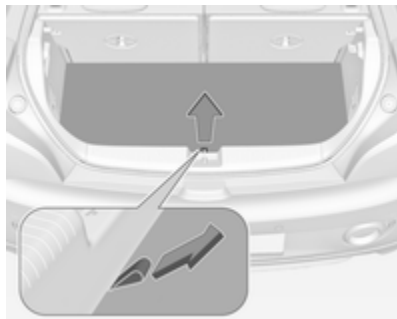

Lift up rear floor cover to gain access to emergency breakdown equipment.
Tools ⇨ 186.

Subwoofer cover

Lift up rear part of floor cover to gain access to the warning triangle.

When closing floor cover, ensure it is fixed with the Velcro fastener.

Removal

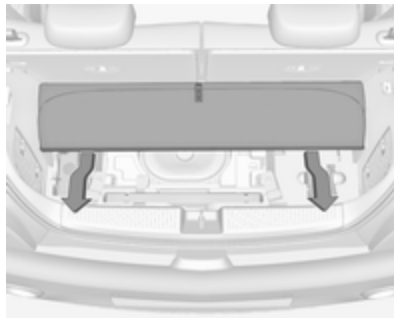

Remove floor cover to gain access to emergency breakdown equipment and for bulb replacement of tail lights:

- Lift up and fold the rear part to the front.
- Pull out the cover to the rear, it will be lifted slightly by a guide.
- Detach the cover from the load compartment.



To gain access to the right cover in the load compartment, e.g. for bulb replacement, fold down rear right backrest and pull out the tool box beside the subwoofer.

Bulb replacement ⇨ 175.

Installation

- Install the tool box if removed.
- Place the floor cover in load compartment.

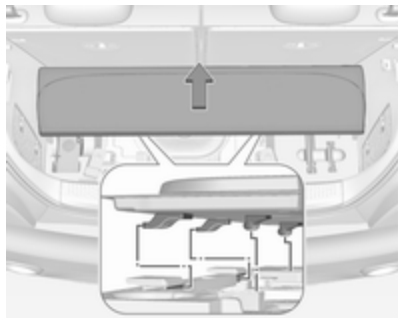

- Move the floor cover slowly to the front, taking care that the guiding bolts slide into the attachments of the load compartment, and allow the floor cover to lower into position.
- Close the floor cover by folding the upper part to the rear, and fix it with the Velcro fastener.
- Fold up the rear backrests.

General hint

⚠ Warning

For safety reasons, stow all parts in the load compartment in its position, always drive with a closed rear floor cover and, if possible, with folded up rear backrests.

Otherwise, vehicle occupants could be injured by objects being thrown around in the event of sharp braking, a sudden change in direction or an accident.

Lashing eyes

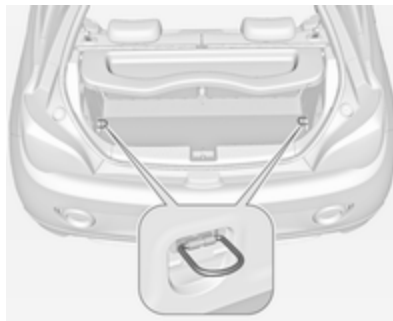

The lashing eyes are designed to secure items against slippage, e.g. using lashing straps or luggage net.

Warning triangle



The warning triangle is stowed with elastic straps in the load compartment below the tailgate.

If the vehicle is equipped with a storage box in the load compartment, remove the storage box to gain access to the warning triangle ↪ 65.

Version with subwoofer box

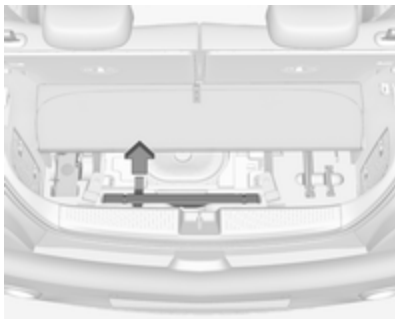

Lift up the rear part of the floor cover. Pull the handle to remove the warning triangle.

Rear floor storage cover ⇨ 67.

First aid kit



Stow the first aid kit in the side panel storage near the rear seats.

Roof rack system

Roof rack

For safety reasons and to avoid damage to the roof, the vehicle approved roof rack system is recommended. For further information contact your workshop.

Follow the installation instructions and remove the roof rack when not in use.

Mounting roof rack

Open the cover from each mounting point by using a coin.



Loading information



- Heavy objects in the load compartment should be placed against the seat backrests. Ensure that the backrests are securely engaged. If objects can be stacked, heavier objects should be placed at the bottom.
- Secure objects with lashing straps attached to the lashing eyes ↪ 68.
- Use the hook at the right sidewall of the load compartment for hanging up carrier bags. Maximum load: 5 kg.

- Secure loose objects in the load compartment to prevent them from sliding.
- When transporting objects in the load compartment, the backrests of the rear seats must not be angled forward.
- Do not allow the load to protrude above the upper edge of the backrests.
- Do not place any objects on the load compartment cover or the instrument panel, and do not cover the sensor on top of the instrument panel.
- The load must not obstruct the operation of the pedals, parking brake and gear selector lever, or hinder the freedom of movement of the driver. Do not place any unsecured objects in the interior.
- Do not drive with an open load compartment.

⚠ Warning

Always make sure that the load in the vehicle is securely stowed. Otherwise objects can be thrown around inside the vehicle and cause personal injury or damage to the load or vehicle.

- The payload is the difference between the permitted gross vehicle weight (see identification plate ↪ 218) and the EC kerb weight.
To calculate the payload, enter the data for your vehicle in the weights table at the front of this manual.
The EC kerb weight includes weights for the driver (68 kg), luggage (7 kg) and all fluids (fuel tank 90% full).
Optional equipment and accessories increase the kerb weight.
- Driving with a roof load increases the sensitivity of the vehicle to cross-winds and has a

detrimental effect on vehicle handling due to the vehicle's higher centre of gravity.

Distribute the load evenly and secure it properly with retaining straps. Adjust the tyre pressure and vehicle speed according to the load conditions. Check and retighten the straps frequently.

Do not drive faster than 120 km/h.

The permissible roof load is 50 kg. The roof load is the combined weight of the roof rack and the load.

Instruments and controls

Controls	73
Steering wheel adjustment	73
Steering wheel controls	73
Heated steering wheel	73
Horn	74
Windscreen wiper/washer	74
Rear window wiper/washer	75
Outside temperature	76
Clock	77
Power outlets	78
Inductive charging	79
Cigarette lighter	80
Ashtrays	80
Warning lights, gauges and indicators	81
Instrument cluster	81
Speedometer	81
Odometer	81
Trip odometer	81
Tachometer	81
Fuel gauge	82
Fuel selector	82
Engine coolant temperature gauge	83

Service display	84
Control indicators	85
Turn signal	87
Seat belt reminder	87
Airbag and belt tensioners	88
Airbag deactivation	88
Charging system	88
Malfunction indicator light	89
Service vehicle soon	89
Brake and clutch system	89
Operate pedal	89
Antilock brake system (ABS)	90
Upshift	90
Power steering	90
Ultrasonic parking assist	90
Electronic Stability Control off	90
Electronic Stability Control and Traction Control system	90
Tyre pressure monitoring system	91
Engine oil pressure	91
Low fuel	91
Immobiliser	92
Exterior light	92
High beam	92
Rear fog light	92
Cruise control	92
Door open	92
Information displays	92
Driver Information Centre	92
Colour-Info-Display	97
Graphic-Info-Display	98
Vehicle messages	99
Warning chimes	101
Battery voltage	101
Vehicle personalisation	102
Telematics service	106
OnStar	106

Controls

Steering wheel adjustment



Unlock lever, adjust steering wheel, then engage lever and ensure it is fully locked.

Do not adjust steering wheel unless vehicle is stationary and steering wheel lock has been released.

Steering wheel controls





The Infotainment system, the cruise control and a connected mobile phone can be operated via the controls on the steering wheel.

Further information is available in the Infotainment manual.

Driver assistance systems ⇨ 145.

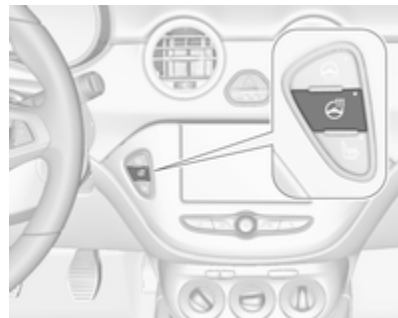
Heated steering wheel



Activate heating by pressing . Activation is indicated by the LED in the button.



The highlighted grip areas of the steering wheel are heated quicker and to a higher temperature than the other areas.

Heating is operational when the engine is running and during an Autostop.

Stop-start system ⇨ 131.

Horn

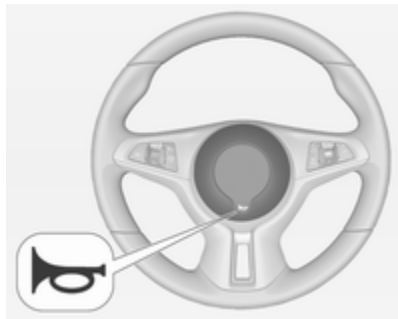

Press .

Windscreen wiper/washer

Windscreen wiper

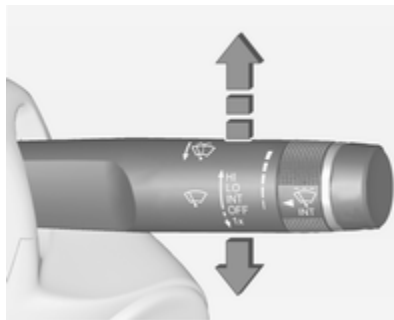

HI : fast
LO : slow
INT : interval wiping

or

automatic wiping with rain sensor

OFF : off

For a single wipe when the windscreen wiper is off, press the lever down to position **1x**.

Do not use if the windscreen is frozen.

Switch off in car washes.

Adjustable wiper interval

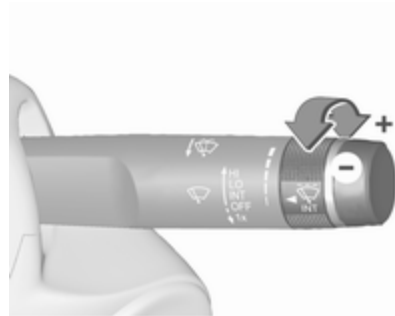

Wiper lever in position **INT**.

Turn the adjuster wheel to adjust the wiping frequency.

Adjustable sensitivity of the rain sensor



Wiper lever in position **INT**.

Turn the adjuster wheel to adjust the sensitivity of the rain sensor.

The rain sensor detects the amount of water on the windscreen and automatically regulates the wiping frequency and speed.

After 20 seconds without wiping activity the wiper arms move slightly down to park position.

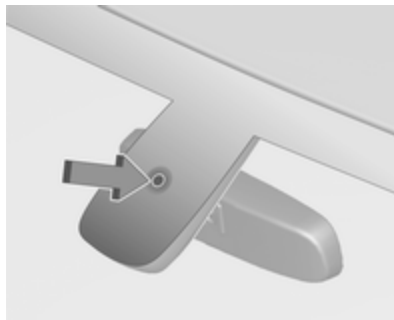

Keep the sensor free from dust, dirt and ice.

Windscreen washer



Pull lever. Washer fluid is sprayed onto the windscreen and the wiper wipes a few times.

Washer fluid ↗ 168

Rear window wiper/washer

Rear window wiper



Press the rocker switch to activate the rear window wiper:

- ON** : continuous operation
- OFF** : off
- INT** : intermittent operation

Do not use if the rear window is frozen.

Switch off in car washes.

The rear window wiper comes on automatically when the windscreen wiper is switched on and reverse gear is engaged.

Activation or deactivation of this function can be changed in the menu **Settings** in the Info-Display.

Vehicle personalisation ⇨ 102.

Rear window washer



Push lever. Washer fluid is sprayed onto the rear window and the wiper wipes a few times.

Washer fluid ⇨ 168

Outside temperature

A drop in temperature is indicated immediately and a rise in temperature after a time delay. Temperatures below 3 °C are displayed flashing.



Illustration shows Graphic-Info-Display.



Illustration shows Colour-Info-Display.

Uplevel-Display



If outside temperature drops to 3 °C, a warning message is displayed in the Driver Information Centre.

⚠ Warning

The road surface may already be icy even though the display indicates a few degrees above 0 °C.

Clock

Graphic-Info Display

Press **CONFIG** to open the **Settings** menu.

Scroll through the list and select the menu item **Time Date** to display the respective submenu.



Note

For a detailed description of menu operation, refer to the Infotainment manual.

Set time



Press the **MENU-TUNE** knob to enter the **Set time** submenu.

Turn the **MENU-TUNE** knob to change the current value of the first setting.

Press the **MENU-TUNE** knob to confirm the set value.

The cursor then switches to the next value. If all values are set, you are automatically returned to the next higher menu level.

Set date



Press the **MENU-TUNE** knob to enter the **Set date** submenu.

Turn the **MENU-TUNE** knob to change the current value of the first setting.

Press the **MENU-TUNE** knob to confirm the set value.

The cursor then switches to the next value. If all values are set, you are automatically returned to the next higher menu level.

Set time format

To switch between the available options, repeatedly press the **MENU-TUNE** knob.

Set date format

To switch between the available options, repeatedly press the **MENU-TUNE** knob.

RDS clock synchronization

The RDS signal of most VHF transmitters automatically sets the time. RDS time synchronisation can take a few minutes. Some transmitters do not send a correct time signal. In such cases, it is recommended to switch off the automatic time synchronisation.

To switch between the options **On** and **Off**, repeatedly press the **MENU-TUNE** knob.

Colour-Info Display

Press  then select **Settings** screen.

Select **Time and Date** to display the respective submenu.

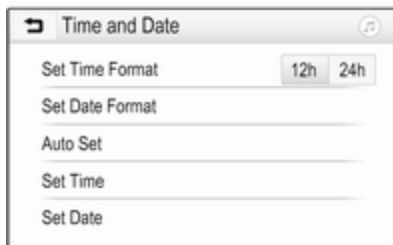

Set Time Format

To select the desired time format, touch the screen buttons **12 h** or **24 h**.

Set Date Format

To select the desired date format, select **Set Date Format** and choose between the available options in the submenu.

Auto Set

To choose whether time and date are to be set automatically or manually, select **Auto Set**.

For time and date to be set automatically, select **On - RDS**.

For time and date to be set manually, select **Off - Manual**. If **Auto Set** is set to **Off - Manual**, the submenu items **Set Time** and **Set Date** become available.

Set time and date

To adjust the time and date settings, select **Set Time** or **Set Date**.

Touch **+** and **-** to adjust the settings.

Power outlets



A 12 Volt power outlet is located in the centre console.

Do not exceed the maximum power consumption of 120 watts.

With ignition off, the power outlet is deactivated. Additionally, the power outlet is deactivated in the event of low vehicle battery voltage.

Electrical accessories that are connected must comply with the electromagnetic compatibility requirements laid down in DIN VDE 40 839.

Do not connect any current-delivering accessories, e.g. electrical charging devices or batteries.

Do not damage the outlet by using unsuitable plugs.

Stop-start system ⇨ 131.

Inductive charging

⚠ Warning

Inductive charging can affect the operation of implanted pacemakers or other medical devices. If applicable, seek medical advice before using the inductive charging device.

⚠ Warning

Remove any metal objects from the charging device before charging a mobile phone, as these objects could become very hot.



To charge a device, the ignition must be switched on.

LED status on the charging device (see arrow):

- Illuminates green:
 - mobile phone with inductive charging functionality was recognised.
- Illuminates yellow:
 - metal objects have been detected in the charging area. Remove objects to allow charging.
 - mobile phone was not placed properly.

PMA or Qi compatible mobile phones can be charged inductively.

A back cover with an integrated coil (e.g. Samsung 4 and 5) or a jacket (e.g. some iPhone models) may be required to charge a mobile phone.

The mobile phone must be smaller than 8 cm in width and 15 cm in length to fit into the charging device.

Protective cover for the mobile phone could have impact on the inductive charging.

To charge a mobile phone:

1. Remove all objects from the charging device.
2. Place the mobile phone with the display facing upwards on the charging device.
3. Ensure that the mobile phone is located at the right bottom corner of the charging device.

In the case that the yellow LED illuminates:

1. Remove the mobile phone from the charging device.
2. Rotate the mobile phone by 180°.
3. Wait three seconds after the LED has extinguished and place the mobile phone on the charging device again.
4. Ensure that the mobile phone is located at the right bottom corner of the charging device.

Cigarette lighter



The cigarette lighter is located in the centre console.

Press in cigarette lighter. It switches off automatically once the element is glowing. Pull out lighter.

Ashtrays

Caution
To be used only for ash and not for combustible rubbish.

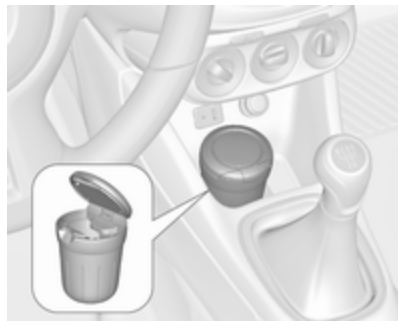

The portable ashtray can be placed in the cupholders.

Warning lights, gauges and indicators

Instrument cluster

The needles of the instruments briefly rotate to the end position when the ignition is switched on.

Speedometer



Indicates vehicle speed.

Odometer

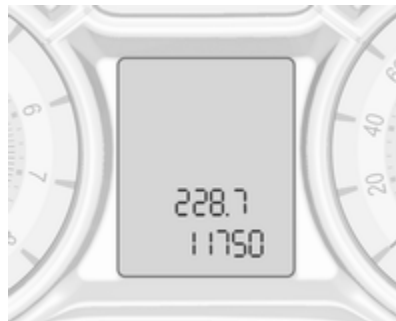

The bottom line displays the recorded distance in km.

Trip odometer

The top line displays the recorded distance since the last reset.

To reset, press **SET/CLR** on the turn signal lever for a few seconds
↔ 92.

Trip odometer counts up to a distance of 2000 km and then restarts at 0.

Tachometer



Displays the engine speed.

Drive in a low engine speed range for each gear as much as possible.

Caution

If the needle is in the red warning zone, the maximum permitted engine speed is exceeded. Engine at risk.

Fuel gauge



Displays the level in the fuel tank.

The arrow indicates the vehicle side where the fuel filler flap is located.

During liquid gas operation, the level in the gas tank is displayed.

Control indicator  illuminates if the level in the tank is low. Refuel immediately if it flashes.

During liquid gas operation, the system automatically switches over to petrol operation when gas tanks are empty ⇨ 82.

Never run the fuel tank dry.

Because of the fuel remaining in the tank, the top-up quantity may be less than the specified tank capacity.

Fuel selector

Pressing **LPG** switches between petrol and liquid gas operation as soon as the required parameters (coolant temperature, gas temperature and minimum engine speed) have been reached. The requirements are usually fulfilled after approx. 60 seconds (depending on exterior temperature) and the first firm press on the accelerator. The LED status shows the current operating mode.



Press **LPG**. The LED in the button shows the current operating mode.

LED off : petrol operation
 LED flashes : checking conditions for fuel transition to liquid gas operation.
 Illuminates if conditions are fulfilled.

LED illuminates : liquid gas operation
 LED flashes five times and extinguishes : liquid gas tank is empty or failure in liquid gas system. A message is displayed in the Driver Information Centre.

If the fuel tank is empty, the engine will not start.

The selected fuel mode is stored and reactivated at the next ignition cycle, if conditions allow.

As soon as the liquid gas tanks are empty, petrol operation is automatically engaged until the ignition is switched off.

When switching automatically between petrol or gas operation, a brief delay of engine tractive power may be noticeable.

Every six months, run the petrol tank down until control indicator  illuminates, then refuel. This helps maintain fuel quality and system function for petrol operation.

Fill the tank completely at regular intervals to prevent corrosion in the tank.

Fuel for liquid gas operation ⇨ 159.

Faults and remedies

If gas mode is not possible, check the following:

- Is there enough liquid gas present?
- Is there enough petrol present for starting?

Due to extreme temperatures in combination with the gas composition, it may take slightly longer before the system switches from petrol to gas mode.

In extreme situations, the system may also switch back to petrol mode if the minimum requirements are not fulfilled. If conditions allow, it might be possible to manually switch back to liquid gas operation.

Seek the assistance of a workshop in the event of all other faults.

Caution

Repairs and adjustments may only be made by trained specialists in order to maintain the safety and warranty on the LPG system.

Liquid gas is given a particular odour (odorised) so that any leaks can be detected easily.

Warning

If you smell gas in the vehicle or in the immediate vicinity, switch to petrol mode immediately. No smoking. No naked flames or ignition sources.

If the gas odour persists, do not start the engine. Have the cause of the fault remedied by a workshop.

When using underground car parks, follow the instructions of the operator and local laws.

Note

In the event of an accident, switch off the ignition and lights.

Engine coolant temperature gauge



Displays the coolant temperature.

- left area : engine operating temperature not yet reached
- central area : normal operating temperature
- right area : temperature too high

Caution

If engine coolant temperature is too high, stop vehicle, switch off engine. Danger to engine. Check coolant level.

Service display

The engine oil life system lets you know when to change the engine oil and filter. Based on driving conditions, the interval at which an engine oil and filter change will be indicated can vary considerably.

Midlevel-Display

The remaining engine oil life duration is displayed in percent beside the control indicator  on the Midlevel-Display.

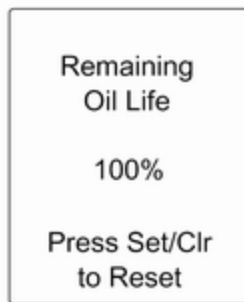

Uplevel-Display

The remaining oil life duration is displayed in percent in the **Vehicle Information Menu** on the Uplevel-Display.

To display the remaining engine oil life duration use turn signal lever buttons:

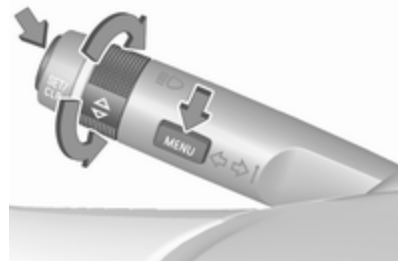

Press **MENU** to select the **Vehicle Information Menu**.

Turn the adjuster wheel to select **Remaining Oil Life**.

Reset

Press **SET/CLR** on turn signal lever for several seconds to reset. The remaining engine oil life duration page must be active. Switch on ignition only, engine must be switched off.

The system must be reset every time the engine oil is changed to ensure proper functionality. Seek the assistance of a workshop.

Next service

When the system has calculated that engine oil life has diminished, a warning message appears in the Driver Information Centre. Have engine oil and filter changed by a workshop within one week or 500 km (whichever occurs first).

Driver Information Centre ⇨ 92.

Service information ⇨ 213.

Control indicators

The control indicators described are not present in all vehicles. The description applies to all instrument versions. Depending on the equipment, the position of the control indicators may vary.

When the ignition is switched on, most control indicators will illuminate briefly as a functionality test.

The control indicator colours mean:

red : danger, important reminder
yellow : warning, information, fault
green : confirmation of activation
blue : confirmation of activation
white : confirmation of activation

Control indicators in the instrument cluster

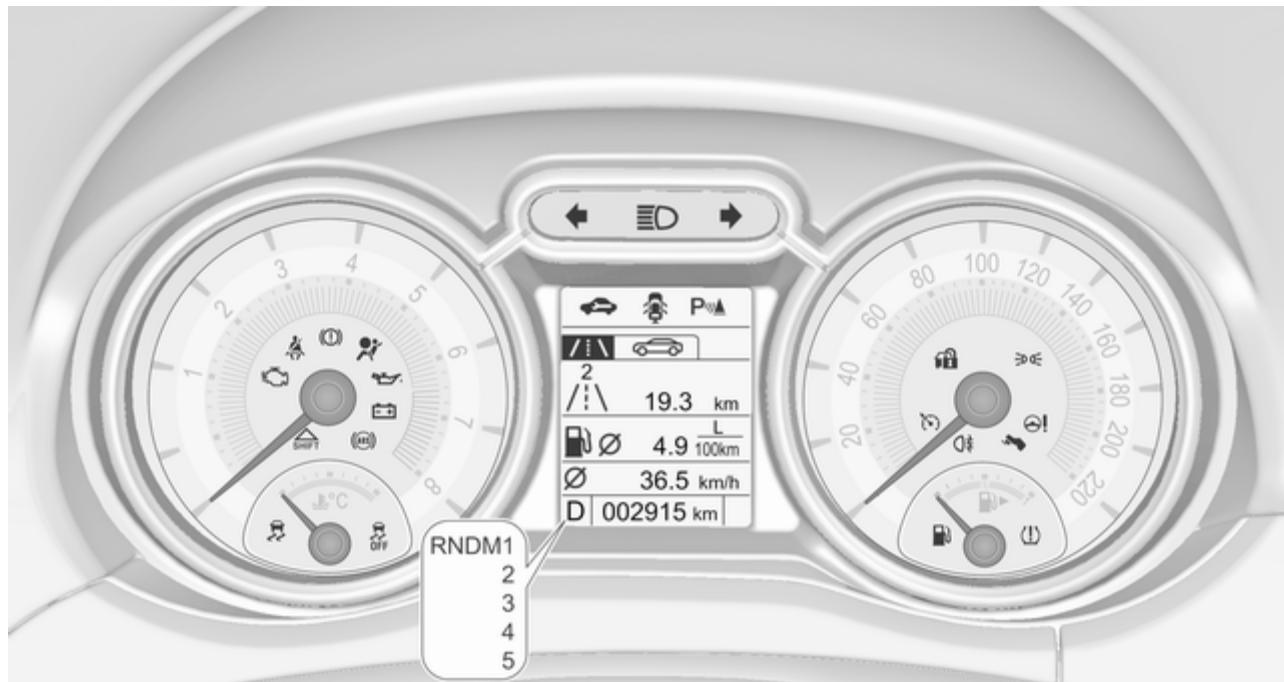

Control indicators in the centre console



Overview

- ↔ Turn signal ⇨ 87
- 🚗 Seat belt reminder ⇨ 87
- 🚗 Airbag and belt tensioners ⇨ 88
- 🚗 Airbag deactivation ⇨ 88
- 🔌 Charging system ⇨ 88
- 🚗 Malfunction indicator light ⇨ 89
- 🚗 Service vehicle soon ⇨ 89

- 🚗 Brake and clutch system ⇨ 89
- 🚗 Operate pedal ⇨ 89
- 🚗 Antilock brake system (ABS) ⇨ 90
- 🚗 Upshift ⇨ 90
- 🚗 Power steering ⇨ 90
- 🚗 Ultrasonic parking assist ⇨ 90
- 🚗 Electronic Stability Control off ⇨ 90
- 🚗 Electronic Stability Control and Traction Control system ⇨ 90
- 🚗 Tyre pressure monitoring system ⇨ 91
- 🚗 Engine oil pressure ⇨ 91
- 🚗 Low fuel ⇨ 91
- 🚗 Immobiliser ⇨ 92
- 🚗 Exterior light ⇨ 92
- 🚗 High beam ⇨ 92
- 🚗 Rear fog light ⇨ 92

- 🚗 Cruise control ⇨ 92
- 🚗 Door open ⇨ 92

Turn signal

↔ illuminates or flashes green.

Illuminates briefly

The parking lights are switched on.

Flashes

A turn signal or the hazard warning flashers are activated.

Rapid flashing: failure of a turn signal light or associated fuse.

Bulb replacement ⇨ 171, Fuses ⇨ 181.

Turn signals ⇨ 113.

Seat belt reminder

Seat belt reminder on front seats

🚗 for driver's seat illuminates or flashes red in the tachometer.

 for front passenger seat illuminates or flashes red in the centre console, when the seat is occupied.

Illuminates

After the ignition has been switched on until the seat belt has been fastened.

Flashes

After having started the engine for a maximum of 100 seconds until the seat belt has been fastened.

Fastening the seat belt ⇨ 40.

Seat belt status on rear seats



 in the Driver Information Centre flashes or illuminates.

Illuminates

After having started the engine for a minimum of 35 seconds until the seat belt has been fastened.

If an unfastened seat belt is fastened whilst driving.

Flashes

After starting off when the seat belt is unfastened.

Fastening the seat belt ⇨ 40.

Airbag and belt tensioners

 illuminates red.

When the ignition is switched on, the control indicator illuminates for approx. four seconds. If it does not illuminate, does not go out after four seconds or illuminates whilst driving, there is a fault in the airbag system. Seek the assistance of a workshop. The airbags and belt pretensioners may fail to trigger in the event of an accident.

Deployment of the belt pretensioners or airbags is indicated by continuous illumination of .

Warning

Have the cause of the fault remedied immediately by a workshop.

Belt pretensioners, airbag system
⇨ 39, ⇨ 41.

Airbag deactivation

 illuminates yellow.

Illuminates for approx. 60 seconds after the ignition is switched on. The front passenger airbag is activated.

 illuminates yellow.

The front passenger airbag is deactivated.

Airbag deactivation ⇨ 46.

Charging system

 illuminates red.

Illuminates when the ignition is switched on and extinguishes shortly after the engine starts.

Illuminates when the engine is running

Stop, switch off engine. Vehicle battery is not charging. Engine cooling may be interrupted. The brake servo unit may cease to be effective. Seek the assistance of a workshop.

Malfunction indicator light

 illuminates or flashes yellow.

Illuminates when the ignition is switched on and extinguishes shortly after the engine starts.

Illuminates when the engine is running

Fault in the emission control system. The permitted emission limits may be exceeded. Seek the assistance of a workshop immediately.

Flashes when the engine is running

Fault that could lead to catalytic converter damage. Ease up on the accelerator until the flashing stops. Seek the assistance of a workshop immediately.

Service vehicle soon

 illuminates yellow.

Additionally, a warning message is displayed in the Driver Information Centre.

The vehicle needs a service.

Seek the assistance of a workshop.

Vehicle messages ⇨ 99.

Brake and clutch system

 illuminates red.

The brake and clutch fluid level is too low, when manual parking brake is not applied ⇨ 169.

⚠ Warning

Stop. Do not continue your journey. Consult a workshop.

Illuminates when the manual parking brake is applied and ignition is switched on ⇨ 140.

Operate pedal

 illuminates or flashes yellow.

Illuminates

Clutch pedal must be depressed to start the engine in Autostop mode. Stop-start system ⇨ 131.

Flashes

Clutch pedal must be depressed to start the engine with the key ⇨ 18, ⇨ 130.

On some versions, the Driver Information Centre indicates a message to operate the clutch pedal ⇨ 99.

Antilock brake system (ABS)

 illuminates yellow.

Illuminates for a few seconds after the ignition is switched on. The system is ready for operation when the control indicator extinguishes.

If the control indicator does not go out after a few seconds, or if it illuminates while driving, there is a fault in the ABS. The brake system remains operational but without ABS regulation.

Antilock brake system ⇨ 139.

Upshift

 illuminates green as control indicator or is shown as a symbol in the Driver Information Centre with Uplevel-Display, when upshifting is recommended for fuel saving reasons.

Eco information menu

The gear shift indication is popped-up as a full page in the Driver Information Centre.

EcoFlex drive assistant ⇨ 92.

Power steering

 illuminates yellow.

Illuminates with power steering disabled

Failure in the power steering system. Consult a workshop.

Illumination of and simultaneously

Power steering system must be calibrated, system calibration ⇨ 143.

Ultrasonic parking assist

 illuminates yellow.

Fault in system

or

Fault due to sensors that are dirty or covered by ice or snow

or

Interference due to external sources of ultrasound. Once the source of interference is removed, the system will operate normally.

Have the cause of the fault in the system remedied by a workshop.

Ultrasonic parking assist ⇨ 148.

Electronic Stability Control off

 illuminates yellow.

The system is deactivated.

Electronic Stability Control and Traction Control system

 flashes or illuminates yellow.

Flashes

The system is actively engaged. Engine output may be reduced and the vehicle may be braked automatically to a small degree.

Illuminates

A fault in the system is present. A warning message appears in the Driver Information Centre. Continued driving is possible. The system is not

operational. Driving stability, however, may deteriorate depending on road surface conditions.

Have the cause of the fault remedied by a workshop.

Electronic Stability Control ⇨ 142,
Traction Control system ⇨ 141.

Tyre pressure monitoring system

⚠ illuminates or flashes yellow.

Illuminates

Tyre pressure loss. Stop immediately and check tyre pressure.

Flashes

Fault in system or tyre without pressure sensor mounted (e.g. spare wheel). After 60-90 seconds the control indicator illuminates continuously. Consult a workshop.

Tyre pressure monitoring system ⇨ 189.

Engine oil pressure

🚗 illuminates red.

Illuminates when the ignition is switched on and extinguishes shortly after the engine starts.

Illuminates when the engine is running

Caution

Engine lubrication may be interrupted. This may result in damage to the engine and/or locking of the drive wheels.

1. Depress the clutch.
2. Select neutral gear.
3. Move out of the flow of traffic as quickly as possible without impeding other vehicles.
4. Switch off ignition.

⚠ Warning

When the engine is off, considerably more force is needed to brake and steer.

During an Autostop the brake servo unit will still be operational.

Do not remove key until vehicle is stationary, otherwise the steering wheel lock could engage unexpectedly.

Check oil level before seeking the assistance of a workshop ⇨ 167.

Low fuel

🚗 illuminates or flashes yellow.

Illuminates

Level in fuel tank is too low.

Flashes

Fuel used up. Refuel immediately. Never run the tank dry.

Refuelling ⇨ 160.

Catalytic converter ⇨ 134.

Immobiliser

 flashes yellow.

Fault in the immobiliser system. The engine cannot be started.

Exterior light

 illuminates green.

The exterior lights are on  110.

High beam

 illuminates blue.

Illuminated when high beam is on or during headlight flash  111.

Rear fog light

 illuminates yellow.

The rear fog light is on  113.

Cruise control

 illuminates white or green.

Illuminates white

The system is on.

Illuminates green

Cruise control is active.

Cruise control  145.

Door open

 illuminates red.

A door or the tailgate is open.

Information displays

Driver Information Centre

The Driver Information Centre is located in the instrument cluster.

It is available as Midlevel-Display or Uplevel-Display.

Midlevel-Display



Indication of:

- overall odometer
- trip odometer
- control indicators
- vehicle information menu, see following

- trip/fuel information menu, see following
- vehicle messages, displayed as code numbers ⇨ 99.

Select menu pages by pressing **MENU** or turning the adjuster wheel on the turn signal lever.

Some of the displayed functions differ when the vehicle is being driven or at a standstill. Some functions are only available when the vehicle is being driven.

Vehicle information menu and trip/fuel information menu are selectable pages, while vehicle messages and control indicators pop-up when required.

Uplevel-Display



Indication of:

- Trip/Fuel Information Menu / \
- Vehicle Information Menu 
- ECO Information Menu ECO

Select menu pages by pressing **MENU** on the turn signal lever; main menu symbols are indicated in the top line of the display.

Some of the displayed functions differ when the vehicle is being driven or at a standstill. Some functions are only available when the vehicle is being driven.

Vehicle messages pop-up when required.

Vehicle personalisation ⇨ 102.

Memorised settings ⇨ 23.

Selecting menus and functions

The menus and functions can be selected via the buttons on the turn signal lever.



Press **MENU** to switch between the menus or to return from a submenu to the next higher menu level.

Turn the adjuster wheel to highlight a menu option or to set a numeric value.

Press **SET/CLR** to select a function or to confirm a message.

Trip/Fuel Information Menu / ∞ \

Press **MENU** to select the Trip/Fuel Information Page.

Turn the adjuster wheel to select a submenu.

Midlevel-Display



Midlevel-Display may be available with trip/fuel information menu.

Uplevel-Display



- trip odometer 1
- average consumption 1
- average speed 1



- trip odometer 2

- average consumption 2
- average speed 2



- digital speed
- range
- instantaneous consumption

Selection and indication can be different between Midlevel- and Uplevel-Display.

Two Trip computer

The information of two trip computer can be reset separately for odometer, average consumption and average speed, making it possible to display different trip information.

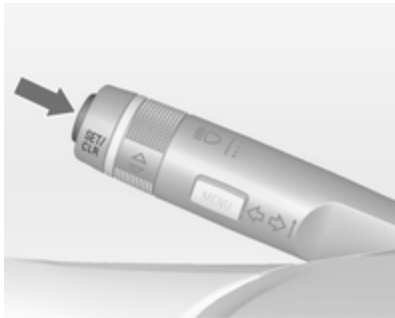

Trip odometer

Trip odometer displays the current distance since a certain reset.

Trip odometer counts up to a distance of 2000 km and then restarts at 0.

Reset trip odometer by pressing **SET/CLR** for a few seconds on the respective page.

Average consumption

Display of average consumption. The measurement can be reset at any time and starts with a default value.

To reset, press **SET/CLR** for a few seconds on the respective page.

On vehicles with LPG engines:
Average consumption is indicated for the currently selected mode (LPG or petrol).

Average speed

Display of average speed. The measurement can be reset at any time.

To reset, press **SET/CLR** for a few seconds on the respective page.

Digital speed

Digital display of the instantaneous speed.

Fuel range

Range is calculated from current fuel tank level and current consumption. The display shows average values.

After refuelling, the range is updated automatically after a brief delay.

When the fuel level in the tank is low, a message appears on the display.  in the fuel gauge illuminates.

When the tank must be refuelled immediately, a warning message pops-up on the display.  in the fuel gauge flashes.

 91.

Fuel range LPG version

Display of approximate fuel range available with the remaining fuel in each respective fuel tank of petrol and LPG fuel, along with a total range of both fuel types together. Switch between the mode by pressing **SET/CLR**.

Instantaneous consumption

Display of the instantaneous consumption.

On vehicles with LPG engines:
Instantaneous consumption is indicated for the currently selected mode; LPG or petrol.

Vehicle Information Menu

Press **MENU** to select the Vehicle Information page.

Turn the adjuster wheel to select a submenu.

Follow the instructions given in the submenus.

- **Unit**

Press **SET/CLR** while page is displayed. Select imperial (unit 1) or metric (unit 3) by turning the adjuster wheel. Press **SET/CLR** to set the unit.

- **Tyre Pressure**

Tyre pressure of all wheels is displayed on this page during driving ⇨ 189.

- **Tyre Load**

The tyre pressure category according to the actually inflated tyre pressure can be selected ⇨ 189.

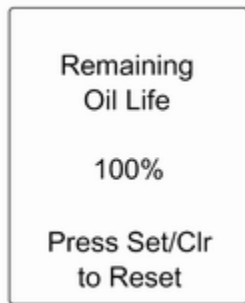

- **Remaining Oil Life**

Indicates an estimate of the oil's useful life. The number in % means the current remaining oil life and indicates when to change the engine oil and filter ⇨ 84.



- **Speed Warning**

The speed warning display alarms when a set speed is exceeded.

To set the speed warning, press **SET/CLR** while the page is displayed. Turn the adjuster wheel to select the value. Press **SET/CLR** to set the speed.

If the selected speed limit is exceeded, a warning chime sounds. Once the speed is set, this feature can be turned off by pressing **SET/CLR** while viewing this page.

Selection and indication can be different between Midlevel- and Uplevel-Display.

ECO Information Menu ECO

Press **MENU** to select **ECO** in the top line of the Display.

Turn the adjuster wheel to select a submenu. Press **SET/CLR** to confirm.

Submenus are:

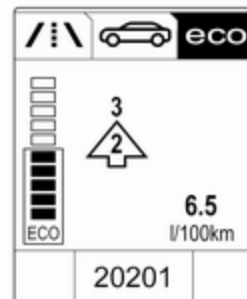

- **Shift indication:** Current gear is indicated inside an arrow. The figure above recommends upshifting for fuel saving reasons.

Eco index display: The current fuel consumption is indicated on a segment display. For economical driving, adapt your driving style to keep the filled segments within the Eco area. The more segments are filled, the higher the fuel consumption. Simultaneously the average consumption value is indicated.

- **Top consumers:** List of top comfort consumers currently switched on is displayed in descending order. Fuel saving potential is indicated.

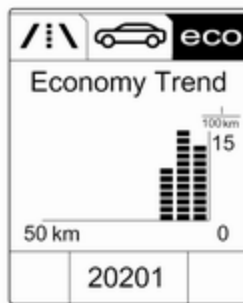

- **Economy Trend:** Displays the average consumption development over a distance of 50 km. Filled segments display the consumption in 5 km steps and shows the effect of topography or driving behaviour on fuel consumption.

Colour-Info-Display

Depending on the vehicle configuration, the vehicle has a Colour-Info-Display with touchscreen functionality.

The Colour-Info-Display with touchscreen functionality indicates in colour:

- time ⇨ 77
- outside temperature ⇨ 76
- date ⇨ 77
- electronic climate control settings ⇨ 121
- parking assist and advanced parking assist instructions ⇨ 148
- Infotainment system, see description in the Infotainment manual
- system messages
- vehicle messages ⇨ 99
- settings for vehicle personalisation ⇨ 102

The type of information and how it is displayed depends on the settings made.

Selecting menus and settings

Menus and settings are selected via the touch screen display.





Press  to switch on the display.

Press  to display the homepage.

Touch required menu display icon with the finger.

Touch a respective icon to confirm a selection.

Touch  to return to the next higher menu level.

Press  to return to the homepage.

For further information, see Infotainment manual.





Vehicle personalisation  102.

Graphic-Info-Display

Depending on the vehicle configuration, the vehicle has a Graphic-Info-Display.



The Graphic-Info-Display indicates:

- time  77
- outside temperature  76
- date  77
- electronic climate control settings  121

- Infotainment system, see description in the Infotainment manual
- settings for vehicle personalisation  102

Selecting menus and settings

Menus and settings are accessed via the display.

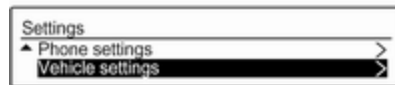

Press **CONFIG**: Menu page **Settings** is displayed.

Turn knob **MENU-TUNE** to select a setting or value.

Press knob **MENU-TUNE** to confirm a setting or value.

Press **BACK** to exit a menu or setting without changing or delete the last character in a character sequence.

Press the **BACK** for a few seconds to delete the entire entry.

To exit the **Settings** menu, press **BACK** repeatedly or press **CONFIG** after confirming the changes.

Vehicle personalisation ⇨ 102.

Memorised settings ⇨ 23.

Vehicle messages

Messages are indicated mainly in the Driver Information Centre, in some cases together with a warning and signal buzzer.



Press **SET/CLR**, **MENU** or turn the adjuster wheel to confirm a message.

Vehicle messages on the Midlevel-Display



The vehicle messages are displayed as code numbers.

No. Vehicle message

- 1 Change engine oil
- 3 Engine coolant level low
- 4 Air conditioning off
- 5 Steering wheel is locked
- 7 Turn steering wheel, switch ignition off then on

No. Vehicle message

- 9 Turn steering wheel, start engine again
- 12 Vehicle overloaded
- 13 Compressor overheated
- 15 Centre high-mounted brake light failure
- 16 Brake light failure
- 17 Headlight levelling malfunction
- 18 Left low beam failure
- 19 Rear fog light failure
- 20 Right low beam failure
- 21 Left sidelight failure
- 22 Right sidelight failure
- 23 Reversing light failure
- 24 Number plate light failure
- 25 Left front turn signal failure
- 26 Left rear turn signal failure
- 27 Right front turn signal failure

No. Vehicle message

- 28 Right rear turn signal failure
- 35 Replace battery in radio remote control
- 48 Clean side blind spot alert system
- 53 Tighten fuel filler cap
- 56 Tyre pressure imbalance on front axle
- 57 Tyre pressure imbalance on rear axle
- 58 Winter tyres detection
- 59 Open then close driver window
- 60 Open then close front passenger window
- 66 Service theft alarm system
- 67 Service steering wheel lock
- 68 Service power steering
- 75 Service air conditioning

No. Vehicle message

- 76 Service side blind spot alert system
- 79 Top up engine oil
- 82 Change engine oil soon
- 84 Engine power reduced
- 89 Service vehicle soon
- 90 Service brake assist
- 95 Service airbag
- 128 Bonnet open
- 134 Parking assist fault, clean bumper
- 136 Service parking assist
- 151 Press clutch to start
- 174 Low vehicle battery
- 258 Parking assist off

Vehicle messages on the Uplevel-Display



The vehicle messages are displayed as text. Follow the instructions given in the messages.

Vehicle messages on the Colour-Info-Display

Some important messages appear additionally in the Colour-Info-Display. Some messages only pop-up for a few seconds.

Warning chimes

When starting the engine or whilst driving

Only one warning chime will sound at a time.

The warning chime regarding unfastened seat belts has priority over any other warning chime.

- If seat belt is not fastened.
- If a door or the tailgate is not fully closed when starting off.
- If a certain speed is exceeded with parking brake applied.
- If a programmed speed is exceeded.
- If a warning message appears in the Driver Information Centre or Info-Display.
- If the parking assist detects an object.
- If the reverse gear is engaged and the rear end carrier extended.

When the vehicle is parked and/or the driver's door is opened

- With exterior lights on.

During an Autostop

- If the driver's door is opened.

Battery voltage

Midlevel-Display

When the vehicle battery voltage is running low, a warning code 174 will appear in the Driver Information Centre.

Uplevel-Display

When the vehicle battery voltage is running low, a warning message will appear in the Driver Information Centre.

1. Switch off immediately any electrical consumers which are not required for a safe drive, e.g. seat heating, heated rear window or other main consumers.
2. Charge the vehicle battery by driving continuously for a while or by using a charging device.

The warning message or warning code will disappear after the engine has been started twice consecutively without a voltage drop.

If the vehicle battery cannot be recharged, have the cause of the fault remedied by a workshop.

Vehicle personalisation

The vehicle's behaviour can be personalised by changing the settings in the Info-Display.

Some of the personal settings for different drivers can be memorised individually for each vehicle key. Memorised settings ⇨ 23.

Depending on vehicle equipment and country-specific regulations some of the functions described below might not be available.

Some functions are only displayed or active when the engine is running.

Personal settings

Graphic-Info-Display

Press **CONFIG** for the Settings menu.

Turn the **MENU-TUNE** knob to move to the desired setup menu, then press **MENU-TUNE**.



Select **Settings** and then **Vehicle settings**.



Vehicle settings

- **Climate and air quality**

Auto fan speed: Modifies the level of the cabin airflow of the climate control in automatic mode.

Air conditioning mode: Controls the state of the cooling compressor when the vehicle is started. Last setting (recommended) or at vehicle start is either always ON or always OFF.

Auto rear demist: Activates automatically rear heated window.

- **Comfort settings**

Chime volume: Changes the volume of warning chimes.

Personalization by driver: Activates or deactivates the personalisation function.

Rear auto wipe in reverse:

Activates or deactivates automatic switching on of the rear window wiper when reverse gear is engaged.

- **Park assist / Collision detection**

Park assist: Activates or deactivates the ultrasonic sensors.

Side blind zone alert: Changes the settings for the side blind spot alert system.

- **Exterior ambient lighting**

Exterior lighting by unlocking:

Activates or deactivates the entry lighting.

Duration upon exit of vehicle:

Activates or deactivates and changes the duration of exit lighting.

- **Power door locks**

Auto door lock: Activates or deactivates the automatic door locking function after switching on ignition.

Stop door lock if door open:

Activates or deactivates the door locking function while a door is open.

Delayed door lock: Activates or deactivates the delayed door locking function. This menu option is displayed with **Stop door lock if door open** deactivated. Central locking system ↻ 23.

- **Remote locking, unlocking, starting**

Remote unlock feedback:

Activates or deactivates the hazard warning flasher feedback whilst unlocking.

Passive door unlock: Changes the configuration to unlock only the driver's door or the whole vehicle whilst unlocking.

Auto relock doors: Activates or deactivates the automatic relock function after unlocking without opening the vehicle.

- **Restore factory settings:**

Resets all settings to the default settings.

Personal settings

Colour-Info-Display

Press , select **Settings** and then **Vehicle** on the touch-screen.



In the corresponding submenus the following settings can be changed:

Vehicle

- **Climate & Air Quality**

Auto Fan Max Speed: Modifies the level of the cabin airflow of the climate control in automatic mode.

Auto Heated Seats:
Automatically activates the seat heating.

Auto Defog: Supports windscreen dehumidification by automatically selecting the necessary settings and automatic air conditioning mode.

Auto Rear Defog: Automatically activates heated rear window.

- **Collision / Detection Systems**

Forward Collision Alert :
Activates or deactivates forward collision alert.

Auto Collision Preparation:
Activates or deactivates the automatic brake functionality of the vehicle in the event of imminent collision danger. The following is selectable: the system will take over brake control, warn by chimes only or is deactivated completely.

Forward Collision System:
Changes the settings of forward collision alert.

Park Assist: Activates or deactivates the ultrasonic parking assist. Activation is selectable with or without attached trailer coupling.

Go Notifier: Activates or deactivates the reminder to drive off when the adaptive cruise control holds the vehicle at standstill.

Side Blind Zone Alert: Activates or deactivates side blind zone alert.

- **Comfort and Convenience**

Auto Memory Recall : Changes the settings to the recall of memorised settings for power seat adjustment.

Easy Exit Driver Seat: Activates or deactivates easy exit function of the power seat.

Chime Volume: Changes the volume of warning chimes.

Personalization By Driver:
Activates or deactivates the personalisation function.

Rain Sense Wipers: Activates or deactivates automatic wiping with rain sensor.

Auto Wipe in Reverse Gear:
Activates or deactivates automatic switching on of the rear window wiper when reverse gear is engaged.

- **Lighting**

Vehicle Locator Lights: Activates or deactivates the entry lighting.

Exit Lighting: Activates or deactivates and changes the duration of exit lighting.

Left or Right Hand Traffic :

Changes between lighting for left or right-hand traffic.

Adaptive Forward Lighting :

Changes the settings of the functions of the LED headlights.

- **Power Door Locks**

Unlocked Door Anti Lock Out:

Activates or deactivates the door locking function while a door is open.

Auto Door Lock: Activates or deactivates the automatic door locking function after switching on ignition.

Delayed Door Lock: Activates or deactivates the delayed door locking function. This feature delays the actual locking of the doors until all doors are closed.

- **Remote Lock, Unlock, Start**

Remote Unlock Light Feedback:

Activates or deactivates the hazard warning flasher feedback whilst unlocking.

Remote Lock Feedback:

Changes what kind of feedback is given when locking the vehicle.

Remote Door Unlock: Changes the configuration to unlock only the driver's door or the whole vehicle whilst unlocking.

Relock Remotely Unlocked

Doors: Activates or deactivates the automatic relock function after unlocking without opening the vehicle.

Remote Window Operation:

Activates or deactivates the operation of power windows with remote control.

Passive Door Unlock: Changes the configuration to unlock only the driver's door or the whole vehicle whilst unlocking.

Passive Door Lock : Activates or deactivates the passive locking function. This feature locks the vehicle automatically after several seconds if all doors have been closed and an electronic key has been removed from the vehicle.

Remote Left in Vehicle Alert:

Activates or deactivates the warning chime when the electronic key remains in the vehicle.

Telematics service

OnStar

OnStar is a personal connectivity and service assistant with integrated Wi-Fi hotspot. The OnStar service is available 24 hours a day, seven days a week.

Note

OnStar is not available for all markets. For further information, contact your workshop.

Note

In order to be available and operational, OnStar needs a valid OnStar subscription, functioning vehicle electrics, mobile service and GPS satellite link.

To activate the OnStar services and set up an account, press  and speak with an advisor.

Depending on the equipment of the vehicle, the following services are available:

- Emergency services and support in the case of a vehicle breakdown
- Wi-Fi hotspot
- Smartphone application
- Remote control, e.g. location of the vehicle, activation of horn and lights, control of central locking system
- Stolen vehicle assistance
- Vehicle diagnostics
- Destination download

Note

The OnStar module of the vehicle is deactivated after ten days without an ignition cycle. Functions requiring a data connection will be available again after switching on the ignition.

OnStar buttons

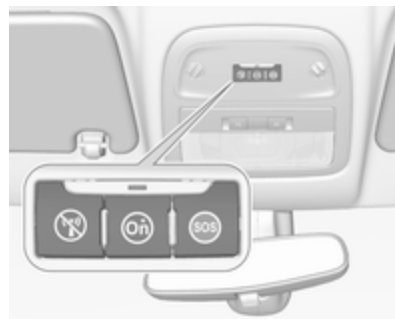

Note

Depending on the equipment, the OnStar buttons can also be integrated in the rear view mirror.

Privacy button

Press and hold  until a message is heard to activate or deactivate the transmission of the vehicle location.

Press  to answer a call or to end a call to an advisor.

Press  to access the Wi-Fi settings.

Service button

Press  to establish a connection to an advisor.

SOS button

Press  to establish a priority emergency connection to a specially trained emergency advisor.

Status LED

Green: The system is ready with activated transmission of the vehicle location.

Green flashing: The system is on a call.

Red: A problem arose.

Off: The system is ready with deactivated transmission of the vehicle location or the system is in standby mode.

Red / green flashing for a short period of time: The transmission of the vehicle location has been deactivated.

OnStar services**General services**

If you need any information e.g. opening hours, points of interest and destinations or if you need any support e.g. in the case of a vehicle

breakdown, a flat tyre and empty fuel tank, press  to establish a connection to an advisor.

Emergency services

In the case of an emergency situation, press  and talk to an advisor. The advisor then contacts emergency or assistance service providers and directs them to your vehicle.

In the case of an accident with activation of airbags or belt tensioners, an automatic emergency call is established. The advisor is immediately connected to your vehicle to see whether help is needed.

Wi-Fi hotspot

The Wi-Fi hotspot of the vehicle provides internet connectivity with a maximum speed of 4G/LTE.

Note

The Wi-Fi hotspot functionality is not available for all markets.

Up to seven devices may be connected.

To connect a mobile device with the Wi-Fi hotspot:

1. Press  and then select Wi-Fi settings on the Info-Display. The settings displayed include the Wi-Fi hotspot name (SSID), password and connection type.
2. Start a Wi-Fi network search on your mobile device.
3. Select your vehicle hotspot (SSID) when listed.
4. When prompted, enter the password on your mobile device.

Note

To change the SSID or password, press  and talk to an advisor or log in to your account.

To switch off the Wi-Fi hotspot functionality, press  to an advisor.

Smartphone app

With the myOpel smartphone app, some vehicle functions can be operated remotely.

The following functions are available:

- Lock or unlock vehicle.
- Honk horn or flash lights.
- Check fuel level, engine oil life and tyre pressure (only with tyre pressure monitoring system).
- Send navigation destination to the vehicle, if equipped with a built-in navigation system.
- Locate vehicle on a map.
- Manage Wi-Fi settings.

To operate these functions, download the app from App Store® or Google Play™ Store.

Remote control

If desired, use any phone to call an advisor, who can remotely operate specific vehicle functions. Find the respective OnStar phone number on our country-specific website.

The following functions are available:

- Lock or unlock vehicle.
- Provide information on the vehicle location.
- Honk horn or flash lights.

Stolen vehicle assistance

If the vehicle is stolen, report the theft to the authorities and request OnStar stolen vehicle assistance. Use any phone to call an advisor. Find the respective OnStar phone number on our country-specific website.

OnStar can provide support in locating and recovering the vehicle.

Theft alert

When the anti-theft alarm system is triggered, a notification is sent to OnStar. You are then informed about this event by text message or email.

Restart prevention

By sending remote signals, OnStar can prevent the vehicle from restarting once it has been turned off.

On-demand diagnostics

At any time e.g. if the vehicle displays a vehicle message, press  to contact an advisor and ask to complete a real-time diagnostic check to directly determine the issue. Depending on the results, the advisor will provide further support.

Diagnostic report

The vehicle automatically transmits diagnostic data to OnStar which sends a monthly email report to you and your preferred workshop.

Note

The workshop notification function can be disabled in your account.

The report contains the status of key operating systems of the vehicle like engine, transmission, airbags, ABS, and other major systems. It also provides information on possible maintenance items and tyre pressure (only with tyre pressure monitoring system).

To look at the information in greater detail, select the link within the email and log in to your account.

Destination download

A desired destination can be directly downloaded to the navigation system.

Press  to call an advisor and describe the destination or point of interest.

The advisor can look up any address or point of interest and directly send the destination to the built-in navigation system.

OnStar settings

OnStar PIN

To have full access to all OnStar services, a four-digit PIN is required. The PIN has to be personalised when first talking to an advisor.

To change the PIN, press **Ⓜ** to call an advisor.

Account data

An OnStar subscriber has an account where all the data is stored. To request a change of the account information, press **Ⓜ** and talk to an advisor or log in to your account.

If the OnStar service is used on another vehicle, press **Ⓜ** and request that the account be transferred to the new vehicle.

Note

In any case, if the vehicle is disposed of, sold or otherwise transferred, immediately inform OnStar about the changes and terminate the OnStar service on this vehicle.

Vehicle location

The vehicle location is transmitted to OnStar when service is requested or triggered. A message on the Info-Display informs about this transmission.

To activate or deactivate the transmission of the vehicle location, press and hold **Ⓜ** until an audio message is heard.

The deactivation is indicated by the status light flashing red and green for a short period of time and each time the vehicle is started.

Note

If the transmission of the vehicle location is deactivated, some services are no longer available.

Note

The vehicle location always remains accessible to OnStar in the case of an emergency.

Find the privacy policy in your account.

Software updates

OnStar may remotely carry out software updates without further notice or consent. These updates are to enhance or maintain safety and security or the operation of the vehicle.

These updates may concern privacy issues. Find the privacy policy in your account.

Lighting

Exterior lighting	110
Light switch	110
Automatic light control	111
High beam	111
Headlight flash	111
Headlight range adjustment	112
Headlights when driving abroad	112
Daytime running lights	112
Hazard warning flashers	112
Turn and lane-change signals .	113
Rear fog lights	113
Parking lights	113
Reversing lights	114
Misted light covers	114
Interior lighting	114
Instrument panel illumination control	114
Interior lights	114
Lighting features	116
Entry lighting	116
Exit lighting	116
Battery discharge protection	117

Exterior lighting

Light switch



Turn light switch:

- O** : lights off
- D** : sidelights
- ID** : headlights

Control indicator **D** **92**.

Light switch with automatic light control



Turn light switch:

- AUTO** : automatic light control: low beam is switched on and off automatically depending on external lighting conditions
- O** : activation or deactivation of the automatic light control. Switch turns back to **AUTO**
- D** : sidelights
- ID** : headlights

The current status of the automatic light control is displayed in the Driver Information Centre.

When switching on the ignition, automatic light control is active.

When headlights are on, $\Rightarrow \Leftarrow$ illuminates. Control indicator $\Rightarrow \Leftarrow$ \hookrightarrow 92.

Tail lights

Tail lights are illuminated together with headlights and sidelights.

Automatic light control



When the automatic light control function is switched on and the engine is running, the system switches between daytime running light and headlights automatically

depending on the lighting conditions and information given by the rain sensor system.

Daytime running light \hookrightarrow 112.

Automatic headlight activation

When the automatic light control function is switched on and the engine is running, the headlights are switched on during poor lighting conditions.

Furthermore the headlights are switched on if the windscreen wipers have been activated for several wipes.

Tunnel detection

When a tunnel is entered the headlights are switched on without any delay.

High beam



To switch from low to high beam, push lever.

To switch to low beam, push lever again or pull.

Headlight flash

To activate the headlight flash, pull lever.

Headlight range adjustment

Manual headlight range adjustment



To adapt headlight range to the vehicle load to prevent dazzling: turn thumb wheel $\frac{1}{4}$ to required position.

- 0 : front seats occupied
- 1 : all seats occupied
- 2 : all seats occupied and load compartment laden
- 3 : driver's seat occupied and load compartment laden

Headlights when driving abroad

The asymmetrical headlight beam extends visibility at the edge of the road at the passenger side.

However, when driving in countries where traffic drives on the opposite side of the road, adjust the headlights to prevent dazzling of oncoming traffic.

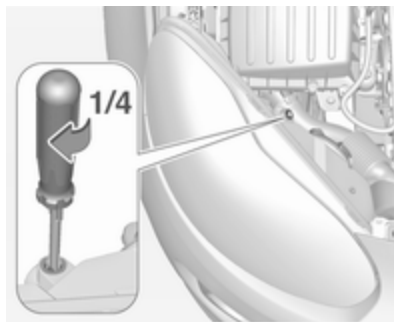

Turn adjuster on both headlight housings $\frac{1}{4}$ turn clockwise to set tourist mode.

Daytime running lights

Daytime running light increases visibility of the vehicle during daylight.

They are switched on automatically when ignition is on.

Hazard warning flashers



Operated by pressing \triangle .

In the event of an accident with airbag deployment the hazard warning flashers are activated automatically.

Turn and lane-change signals

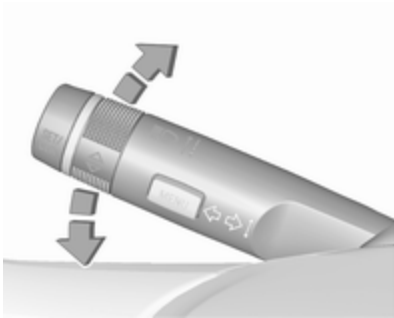

lever up : right turn signal
 lever down : left turn signal

A resistance point can be felt when moving the lever.

Constant flashing is activated when the lever is being moved beyond the resistance point. It is deactivated when the steering wheel is moved in the opposite direction or lever is manually moved back to its neutral position.

Activate temporary flashing by holding the lever just before the resistance point. Turning lights will flash until lever is being released.

To activate three flashes, tap the lever briefly without passing the resistance point.

Rear fog lights



Operated by pressing $\text{Q}\ddot{\text{z}}$.

Light switch in position **AUTO**: switching on rear fog light will switch on headlights automatically.

Parking lights



When the vehicle is parked, the parking lights on one side can be activated:

1. Switch off ignition.
2. Move turn signal lever all the way up (right parking lights) or down (left parking lights).

Confirmed by a signal and the corresponding turn signal control indicator.

Reversing lights

The reversing light comes on when the ignition is on and reverse gear is selected.

Misted light covers

The inside of the light housing may mist up briefly in poor, wet and cold weather conditions, in heavy rain or after washing. The mist disappears quickly by itself; to help switch on the headlights.

Interior lighting

Instrument panel illumination control



Brightness of the following lights can be adjusted when the exterior lights are on:

- instrument panel illumination
- ambient light
- dome light
- Info-Display
- illuminated switches and operation elements

Turn thumb wheel  and hold until the desired brightness is obtained.

Interior lights

Front courtesy light

During entry and exit of the vehicle, the courtesy light automatically switches on then off after a delay.



Operate rocker switch:

 : automatic switching on and off

press  : on

press  : off

Note

In the event of an accident with airbag deployment the courtesy lights are turned on automatically.

Dome light

Spotlight incorporated in the interior lighting comes on when headlights are switched on.

Dome light illuminates gear shifting console indirectly.



Ambient light

Ambient light consists of indirect lights in the doors, in the instrument panel below the doors, in the heating and ventilation unit and in the passenger foot well. 8 colours can be selected by a button in the roof console.



Operate button with ignition switched on:

- ⏻ one brief press : on or off
- ✍ repeated brief presses : colours change in steps
- ✍ long press : colours change continuously

Ambient light can be dimmed with the thumb wheel  together with the instrument panel illumination  114.

The selected colour remains the next time the ignition is switched on.

Ambient light comes on automatically when switching off ignition and extinguishes after opening a door.

Pressing  after switching off ignition; ambient light remains on for 60 minutes.

Starlight panel

Starlight panel consists of approx. 64 LEDs. The intensity can be dimmed with a button in the roof console.



Operate button with ignition switched on:

- ⓘ one brief press : on or off
- *⊛ repeated brief presses : dimming stepwise
- *⊛ long press : dimming continuously

The selected intensity remains the next time the ignition is switched on.

Starlight comes on automatically when switching off ignition and extinguishes after opening a door. Pressing ⓘ after switching off ignition; starlight remains on for 60 minutes.

Lighting features

Entry lighting

Welcome lighting

The following lights are switched on for a short time by unlocking the vehicle with the radio remote control:

- headlights
- tail lights
- number plate lights
- instrument panel light
- interior lights

Some functions are only operable when it is dark outside to facilitate locating the vehicle.

The lighting switches off immediately when the ignition key is turned to position 1 ⇨ 129.

Activation or deactivation of this function can be changed in the Info-Display.

Vehicle personalisation ⇨ 102.

The settings can be saved for the key being used ⇨ 23.

The following lights will additionally switch on when the driver's door is opened:

- illumination of some switches
- Driver Information Centre
- ambient light
- starlight panel

Exit lighting

The following lights switch on if the key is removed from the ignition switch:

- interior lights
- instrument panel light (only when it is dark)
- ambient light
- starlight panel

They will switch off automatically after a delay and will be activated again if the driver's door is opened.

Path lighting

Headlights, tail lights and number plate lights illuminate the surrounding area for an adjustable time after leaving the vehicle.

Activating



1. Switch off the ignition.
2. Remove the ignition key.
3. Open the driver's door.
4. Pull the turn signal lever.
5. Close the driver's door.

If the driver's door is not closed the lights switch off after two minutes.

Exit lighting is switched off immediately if the turn signal lever is pulled while the driver's door is open.

Activation, deactivation and duration of this function can be changed in the Info-Display. Vehicle personalisation ↻ 102.

The settings can be saved for the key being used ↻ 23.

Battery discharge protection

Vehicle battery state of charge function

The function guarantees longest vehicle battery life via a generator with controllable power output and optimised power distribution.

To prevent discharge of the vehicle battery when driving, following systems are reduced automatically in two stages and finally switched off:

- auxiliary heater
- heated rear window
- heated mirrors
- heated seats
- fan

In the second stage a message which confirms the activation of the vehicle battery discharge protection will be displayed in the Driver Information Centre.

Switching off electric lights

To prevent discharge of the vehicle battery when the ignition is switched off, some interior lights are switched off automatically after some time.

Climate control

Climate control systems	118
Heating and ventilation system	118
Air conditioning system	119
Electronic climate control system	121
Air vents	126
Adjustable air vents	126
Fixed air vents	126
Maintenance	126
Air intake	126
Pollen filter	126
Air conditioning regular operation	127
Service	127

Climate control systems

Heating and ventilation system



Controls for:

- temperature
- fan speed
- air distribution

Heated rear window  ⇨ 32.

Heated seats  ⇨ 38.

Heated steering wheel  ⇨ 73.

Temperature

red : warm

blue : cold

Heating will not be fully effective until the engine has reached normal operating temperature.

Fan speed

Adjust the air flow by switching the fan to the desired speed.

Air distribution

 : to head area

 : to head area and foot well

 : to foot well and windscreen



 : to windscreen, front door windows and foot well

 : to windscreen and front door windows

Intermediate settings are possible.

Demisting and defrosting the windows







- Set temperature control to warmest level.
- Set fan speed to highest speed.
- Set air distribution control to .
- Switch on heated rear window .
- Open side air vents as required and direct them towards door windows.
- For simultaneous warming of the foot well, set air distribution control to .

Air conditioning system



Controls for:

- temperature
- fan speed
- air distribution
-  : cooling
-  : air recirculation
-  : heated rear window  32

Heated seats   38.

Heated steering wheel   73.

Temperature





red : warm
blue : cold

Heating will not be fully effective until the engine has reached normal operating temperature.

Fan speed

Adjust the air flow by switching the fan to the desired speed.

Air distribution

-  : to head area
-  : to head area and foot well
-  : to foot well and windscreen
-  : to windscreen, front door windows and foot well
-  : to windscreen and front door windows (air conditioning is activated in the background to help preventing windows from fogging)

Intermediate settings are possible.

Cooling ☀

Press ☀ to switch on cooling. The LED in the button illuminates to indicate activation. Cooling is only functional when the engine is running and climate control fan is switched on.

Press ☀ again to switch off cooling.

The air conditioning system cools and dehumidifies (dries) as soon as the outside temperature is slightly above the freezing point. Therefore condensation may form and drip from under the vehicle.

If no cooling or drying is required, switch off the cooling system for fuel saving reasons.

Activated cooling may inhibit Autostops.

Stop-start system ⇨ 131.

Air recirculation system 🚗

Press 🚗 to activate air recirculation mode. The LED in the button illuminates to indicate activation.

Press 🚗 again to deactivate recirculation mode.

⚠ Warning

The exchange of fresh air is reduced in air recirculation mode. In operation without cooling the air



humidity increases, so the windows may mist up from inside. The quality of the passenger compartment air deteriorates, which may cause the vehicle occupants to feel drowsy.

In warm and very humid ambient air conditions, the windscreen may mist up from outside, when cold air is directed to it. If windscreen mists up from outside, activate windscreen wiper and deactivate 🚗.

Maximum cooling



Briefly open the windows so that hot air can disperse quickly.



- Switch on cooling ☀.
- Air recirculation system  on.
- Set temperature control to coldest level.
- Set fan speed to highest level.
- Set air distribution control to .
- Open all vents.

Demisting and defrosting the windows



- Set temperature control to warmest level.
- Set fan speed to highest level.
- Set air distribution control to .
- Switch on heated rear window .
- Open side air vents as required and direct them towards the door windows.

Note

If air distribution mode  is selected while engine is running, an Autostop will be inhibited until another air distribution is selected.

If air distribution mode  is selected while the engine is in an Autostop, the engine will restart automatically.

Stop-start system  131.

Electronic climate control system



Controls for:

- fan speed
- temperature
- air distribution

 : cooling

AUTO : automatic mode

 : manual air recirculation

 : demisting and defrosting

 : heated rear window ↪ 32

Heated seats  ↪ 38.

Heated steering wheel  ↪ 73.

In Automatic mode temperature, fan speed and air distribution are regulated automatically.



Climate control settings are shown on the Info-Display. Setting modifications are briefly popped-up, superimposed over the currently displayed menu.

The electronic climate control system is only fully operational when the engine is running.

Automatic mode AUTO



Basic setting for maximum comfort:

- Press **AUTO**, the air distribution and fan speed are regulated automatically. The LED in the button illuminates to indicate activation.

- Open all air vents to allow optimised air distribution in automatic mode.
- Press  to switch on optimal cooling and demisting. The LED in the button illuminates to indicate activation.
- Set the preselected temperature using the centre rotary knob. Recommended temperature is 22 °C.

Temperature preselection

Set temperature by turning the centre rotary knob to the desired value. It is indicated in the display of the switch.

For reasons of comfort, change temperature only in small increments.



If the minimum temperature **Lo** is set, the climate control system runs at maximum cooling, if cooling  is switched on.

If the maximum temperature **Hi** is set, the climate control system runs at maximum heating.



Note

If  is switched on, reducing the set cabin temperature can cause the engine to restart from an Autostop or inhibit an Autostop.

Stop-start system ⇨ 131.



Demisting and defrosting the windows





- Press . The LED in the button illuminates to indicate activation.
- Temperature and air distribution are set automatically and the fan runs at high speed.
- Switch on heated rear window .
- To return to previous mode: press , to return to automatic mode: press **AUTO**.

Setting of automatic rear window heating can be changed in the Info-Display. Vehicle personalisation ⇨ 102.

Note

If  is pressed while the engine is running, an Autostop will be inhibited until  is pressed again.

If  is pressed with the fan switched on and the engine running, an Autostop will be inhibited until  is pressed again or until the fan is switched off.

If  is pressed while the engine is in an Autostop, the engine will restart automatically.

If  is pressed with the fan switched on while the engine is in an Autostop, the engine will restart automatically.

Stop-start system ⇨ 131.

Manual settings

Climate control system settings can be changed by activating the buttons and rotary knobs as follows. Changing a setting will deactivate the automatic mode.

Fan speed



Turn left rotary knob to decrease or increase fan speed. The fan speed is indicated in the Info-Display.





Turning knob to : fan and cooling are switched off.

To return to automatic mode: Press **AUTO**.

Air distribution



Turn right rotary knob for desired adjustment. Setting is indicated in the Info-Display.

-  : to foot well and windscreen
-  : to windscreen, front door windows and foot well
-  : to windscreen and front door windows (air conditioning is activated in the background to help preventing windows from fogging)
-  : to head area via adjustable air vents
-  : to head area and foot well

Return to automatic air distribution: press **AUTO**.

Cooling



Press  to switch on cooling. The LED in the button illuminates to indicate activation. Cooling is only functional when the engine is running and climate control fan is switched on.

Press  again to switch off cooling.

The air conditioning system cools and dehumidifies (dries) as soon as the outside temperature is slightly above the freezing point. Therefore condensation may form and drip from under the vehicle.

If no cooling or drying is required, switch off the cooling system for fuel saving reasons.

When the cooling system is switched off, no engine restart will be requested by the climate control system during an Autostop.

Exception: defrost system is activated and outside temperature above 0 °C requests a restart.

Stop-start system ↗ 131.

The status of cooling operation is indicated in the Info-Display.

Activation or deactivation of cooling operation after engine start can be changed in the Info-Display. Vehicle personalisation ↗ 102.

Air recirculation mode



Press  to activate air recirculation mode. The LED in the button illuminates to indicate activation.

Press  again to deactivate recirculation mode.

Warning

The exchange of fresh air is reduced in air recirculation mode. In operation without cooling the air humidity increases, so the windows may mist up from inside. The quality of the passenger

compartment air deteriorates, which may cause the vehicle occupants to feel drowsy.

In warm and very humid ambient air conditions, the windscreen may mist up from outside, when cold air is directed to it. If windscreen mists up from outside, activate windscreen wiper and deactivate .

Basic settings

Some settings can be changed in the Info-Display. Vehicle personalisation ↗ 102.

Air vents

Adjustable air vents

At least one air vent must be open while the cooling is on.

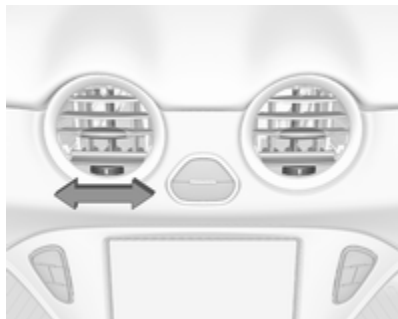

Adjust the air amount at the vent outlet by turning the adjuster wheel. The vent is closed when the adjuster wheel is turned close to the left or right.



Direct the flow of air by tilting and swivelling the slats.

Warning

Do not attach any objects to the slats of the air vents. Risk of damage and injury in case of an accident.

Fixed air vents

Additional air vents are located beneath the windscreen and door windows and in the foot wells.

Maintenance

Air intake



The air intake in front of the windscreen in the engine compartment must be kept clear to allow air intake. Remove any leaves, dirt or snow.

Pollen filter

The pollen filter cleans dust, soot, pollen and spores from the air entering the vehicle through the air intake.

Air conditioning regular operation

In order to ensure continuously efficient performance, cooling must be operated for a few minutes once a month, irrespective of the weather and time of year. Operation with cooling is not possible when the outside temperature is too low.

Service

For optimal cooling performance, it is recommended to annually check the climate control system, starting three years after initial vehicle registration, including:

- functionality and pressure test
- heating functionality
- leakage check
- check of drive belts
- cleaning of condenser and evaporator drainage
- performance check

Note

Refrigerant R-134a contains fluorinated greenhouse gases.

Driving and operating

Driving hints	128
Control of the vehicle	128
Steering	129
Starting and operating	129
New vehicle running-in	129
Ignition switch positions	129
Retained power off	129
Starting the engine	130
Overrun cut-off	130
Stop-start system	131
Parking	133
Engine exhaust	134
Catalytic converter	134
Manual transmission	135
Manual transmission automated	135
Transmission display	136
Starting the engine	136
Selector lever	136
Manual mode	138
Electronic driving programmes	138
Fault	138

Brakes	139
Antilock brake system	139
Parking brake	140
Brake assist	140
Hill start assist	140
Ride control systems	141
Traction Control system	141
Electronic Stability Control	142
City mode	143
Driver assistance systems	145
Cruise control	145
Speed limiter	146
Parking assist	148
Side blind spot alert	157
Fuel	158
Fuel for petrol engines	158
Fuel for liquid gas operation	159
Refuelling	160
Fuel consumption - CO ₂ -	
Emissions	163

Driving hints

Control of the vehicle

Never coast with engine not running

Many systems will not function in this situation (e.g. brake servo unit, power steering). Driving in this manner is a danger to yourself and others.

All systems function during an Autostop.

Stop-start system ⇨ 131.

Idle boost

If charging of the vehicle battery is required due to battery condition, the power output of the generator must be increased. This will be achieved by an idle boost which may be audible.

A message appears on the Uplevel-Display.

Pedals

To ensure the pedal travel is uninhibited, there must be no mats in the area of the pedals.

Use only floor mats, which fit properly and are fixed by the retainers on the driver side.

Steering

If power steering assist is lost because the engine stops or due to a system malfunction, the vehicle can be steered but may require increased effort.

Control indicator  90.

Starting and operating

New vehicle running-in

Do not brake unnecessarily hard for the first few journeys.

During the first drive, smoke may occur because of wax and oil evaporating off the exhaust system. Park the vehicle in the open for a while after the first drive and avoid inhaling the fumes.

During the running-in period fuel and engine oil consumption may be higher.

Autostop may be inhibited to allow for charging the vehicle battery.

Ignition switch positions

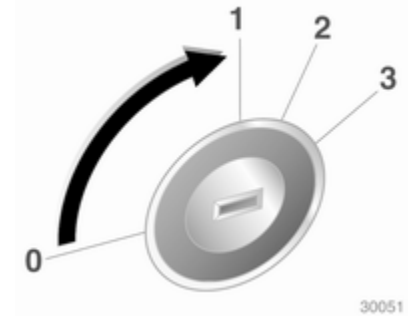

- 0 : ignition off
- 1 : steering wheel lock released, ignition off
- 2 : ignition on
- 3 : starting

Retained power off

The following electronic systems can work until the driver's door is opened or at the latest for ten minutes after the ignition is switched off:

- power windows
- power outlets
- power sunroof

Starting the engine

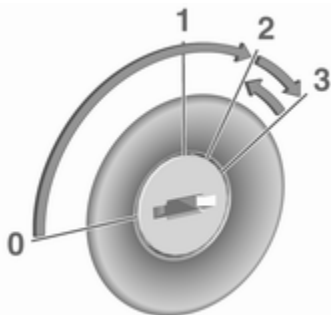

Turn key to position **1** to release the steering wheel lock.

Manual transmission: operate clutch and brake pedal.

Manual transmission automated: operate brake pedal.

Do not operate the accelerator pedal.

Turn key briefly to position **3** and release: an automatic procedure operates the starter after a brief delay, until the engine is running. See 'Automatic Starter Control'.

Before restarting or to switch off the engine, turn the key back to position **0**.

During an Autostop, the engine can be started by depressing the clutch pedal.

Starting the vehicle at low temperatures

The start of the engine without additional heaters is possible down to $-30\text{ }^{\circ}\text{C}$. Required is an engine oil with the correct viscosity, the correct fuel, performed services and a sufficiently charged vehicle battery.

Automatic starter control

This function controls the engine starting procedure. The driver does not need to hold the key in position **3**. Once applied, the system will go on starting automatically until the engine is running. Because of the checking procedure, the engine starts running after a short delay.

Possible reasons for a non-starting engine:

- clutch pedal is not operated (manual transmission).
- brake pedal not operated (manual transmission automated).
- timeout occurred.

Turbo engine warm-up

Upon start-up, engine available torque may be limited for a short time, especially when the engine temperature is cold. The limitation is to allow the lubrication system to fully protect the engine.

Overrun cut-off

The fuel supply is automatically cut off during overrun, i.e. when the vehicle is driven with a gear engaged but accelerator is released.

Depending on driving conditions, the overrun cut-off may be deactivated.

Stop-start system

The stop-start system helps to save fuel and to reduce the exhaust emissions. When conditions allow, it switches off the engine as soon as the vehicle is at a low speed or at a standstill, e.g. at a traffic light or in a traffic jam.

On vehicles with manual transmission, the engine is started automatically as soon as the clutch is depressed.

On vehicles with manual transmission automated, the engine is started automatically as soon as the brake pedal is released.

A vehicle battery sensor ensures that an Autostop is only performed if the vehicle battery is sufficiently charged for a restart.

Activation

The stop-start system is available as soon as the engine is started, the vehicle starts-off and the conditions as stated below in this section are fulfilled.

Deactivation



Deactivate the stop-start system manually by pressing **eco**. The deactivation is indicated when the LED in the button extinguishes.

Autostop

Vehicles with manual transmission: If the vehicle is at a low speed or at a standstill, activate an Autostop as follows:

- Depress the clutch pedal.
- Move the selector lever to neutral.
- Release the clutch pedal.

The engine will be switched off while the ignition stays on.

Vehicles with manual transmission automated:

If the vehicle is at a standstill with depressed brake pedal, Autostop is activated automatically.

The engine will be switched off while the ignition stays on.

The stop-start system will be disabled on inclines of 15% or more.

Indication

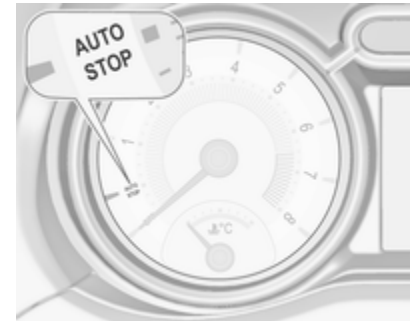

An Autostop is indicated by the needle at the **AUTOSTOP** position in the tachometer.

During an Autostop, the heating and brake performance will be maintained.

Conditions for an Autostop

The stop-start system checks if each of the following conditions is fulfilled:

- The stop-start system is not manually deactivated.
- The bonnet is fully closed.
- The driver's door is closed or the driver's seat belt is fastened.
- The vehicle battery is sufficiently charged and in good condition.
- The engine is warmed up.
- The engine coolant temperature is not too high.
- The engine exhaust temperature is not too high, e.g. after driving with high engine load.
- The ambient temperature is above -5 °C.
- The climate control system allows an Autostop.

- The brake vacuum is sufficient.
- The vehicle was driven at least at walking speed since the last Autostop.

Otherwise an Autostop will be inhibited.

Certain settings of the climate control system may inhibit an Autostop. See 'Climate control' chapter for more details ⇨ 121.

Immediately after motorway driving, an Autostop may be inhibited.

New vehicle running-in ⇨ 129.

Vehicle battery discharge protection

To ensure reliable engine restarts, several vehicle battery discharge protection features are implemented as part of the stop-start system.

Power saving measures

During an Autostop, several electrical features, e.g. the rear window heating, are disabled or switched into a power saving mode. The fan speed of the climate control system is reduced to save power.

Restart of the engine by the driver

Vehicles with manual transmission:

Depress the clutch pedal to restart the engine.

The engine start is indicated by the needle at the idle speed position in the tachometer.

If the selector lever is shifted out of neutral before depressing the clutch first, control indicator  illuminates or is shown as a symbol in the Driver Information Centre.

Control indicator  ⇨ 89.

Vehicles with manual transmission automated:

Release the brake pedal or move selector lever out of **D** to restart the engine.

The engine start is indicated by the needle at the idle speed position in the tachometer.

Restart of the engine by the stop-start system

The selector lever must be in neutral to enable an automatic restart.

If one of the following conditions occurs during an Autostop, the engine will be restarted automatically by the stop-start system:

- The stop-start system is manually deactivated.
- The bonnet is opened.
- The driver's seat belt is unfastened and the driver's door is opened.
- The engine temperature is too low.
- The charging level of the vehicle battery is below a defined level.
- The brake vacuum is not sufficient.
- The vehicle is driven at least at walking speed.
- The climate control system requests an engine start.
- The air conditioning is manually switched on.

If the bonnet is not fully closed, a warning message is displayed in the Driver Information Centre.

If an electrical accessory, e.g. a portable CD player, is connected to the power outlet, a brief power drop during restart might be noticeable.

Parking

Warning

- Do not park the vehicle on an easily ignitable surface. The high temperature of the exhaust system could ignite the surface.
- Always apply the parking brake. Activate the parking brake without pressing the release button. Apply as firmly as possible on a downhill slope or uphill slope. Depress brake pedal at the same time to reduce operating force.
- Switch off the engine.
- If the vehicle is on a level surface or uphill slope, engage first gear before removing the ignition key. On an uphill slope,

turn the front wheels away from the kerb.

If the vehicle is on a downhill slope, engage reverse gear before removing the ignition key. Turn the front wheels towards the kerb.

- Close the windows and the sunroof.
- Remove the ignition key from the ignition switch. Turn the steering wheel until the steering wheel lock is felt to engage.

For vehicles with manual transmission automated, the key can only be removed from the ignition switch when the parking brake is applied.

- Lock the vehicle.
- Activate the anti-theft alarm system.
- The engine cooling fans may run after the engine has been switched off ⇨ 166.

Caution

After running at high engine speeds or with high engine loads, operate the engine briefly at a low load or run in neutral for approx. 30 seconds before switching off, in order to protect the turbocharger.

Note

In the event of an accident with airbag deployment, the engine is turned off automatically if the vehicle comes to a standstill within a certain time.

Engine exhaust**⚠ Danger**

Engine exhaust gases contain poisonous carbon monoxide, which is colourless and odourless and could be fatal if inhaled.

If exhaust gases enter the interior of the vehicle, open the windows. Have the cause of the fault rectified by a workshop.

Avoid driving with an open load compartment, otherwise exhaust gases could enter the vehicle.

Catalytic converter

The catalytic converter reduces the amount of harmful substances in the exhaust gases.

Caution

Fuel grades other than those listed on page ⇨ 158 could damage the catalytic converter or electronic components.

Unburnt petrol will overheat and damage the catalytic converter. Therefore avoid excessive use of the starter, running the fuel tank dry and starting the engine by pushing or towing.

In the event of misfiring, uneven engine running, a reduction in engine performance or other unusual problems, have the cause of the fault rectified by a workshop as soon as possible. In an emergency, driving can be continued for a short period, keeping vehicle speed and engine speed low.

Manual transmission



To engage reverse, depress the clutch pedal and press the release button on the selector lever and engage the gear.

If the gear does not engage, set the lever to neutral, release the clutch pedal and depress again; then repeat gear selection.

Do not slip the clutch unnecessarily.

When operating, depress the clutch pedal completely. Do not use the pedal as a foot rest.

Caution

It is not advisable to drive with the hand resting on the selector lever.

Gear shift indication ⇨ 90.

Stop-start system ⇨ 131.

Manual transmission automated

The automated manual transmission permits manual gearshifting (manual mode) or automatic gearshifting (automatic mode), both with automatic clutch control.

Manual shifting is possible by tapping the selector lever in manual mode.

Note

When unlocking or opening a vehicle door, a sound may be audible caused by the hydraulic system.

Transmission display

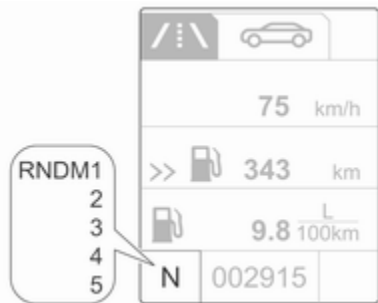

In automatic mode, the driving programme is indicated by **D** in the Driver Information Centre.

In manual mode, **M** and the number of the selected gear is indicated.

R indicates reverse gear.

N indicates neutral.

Starting the engine

To start the engine, depress the brake pedal, if transmission is not in **N**.

Transmission automatically shifts to **N** upon starting. There may be a slight delay.

Starting is not possible if all brake lights fail.

Stop-start-system

Autostop

If the vehicle is at a standstill and brake pedal is operated, Autostop is activated automatically.

The engine will be switched off while the ignition stays on.

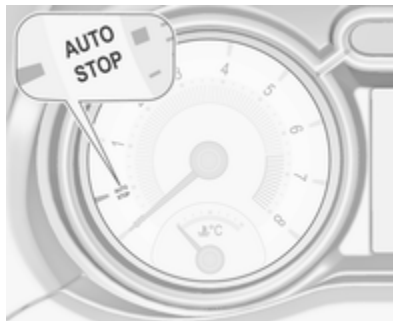

An Autostop is indicated by the needle at the **AUTOSTOP** position in the tachometer.

Autostart

Release the brake pedal or move selector lever out of **D** to restart the engine.

The engine restart is indicated by the needle at the idle speed position in the tachometer.

The stop-start system will be disabled on inclines of 15% or more.

Stop-start-system ↪ 131.

Selector lever



Always move the selector lever in the appropriate direction as far as it will go. Upon release, it automatically returns to the centre position.

Note

Do not hold the selector lever in an intermediate position. Not fully engaging a gear may lead to malfunction and the error code 81 may be displayed in the Driver Information Centre.

Return the selector lever to the centre position. After a short while N will be displayed in the Driver Information Centre and the system will operate normally again.

Vehicle messages ⇨ 99.

- N** : neutral position
- D/M** : switch between automatic (**D**) and manual (**M**) shift mode. The transmission display shows either **D** or **M** with the selected gear
- +** : upshifting in manual mode
- : downshifting in manual mode
- R** : reverse gear. Engage only when vehicle is stationary

If selector lever is moved from **R** to the left, **D** is directly engaged.

If selector lever is moved from **D** to **+** or **-**, the manual mode **M** is selected and the transmission shifts.

Starting off

Depress the brake pedal and move the selector lever to **D/M** or **R**. If **D** is selected, transmission is in automatic mode and first gear is engaged. If **R** is selected, reverse gear is engaged.

The vehicle starts to move when the brake is released.

To start-off without depressing the foot brake, accelerate immediately after engaging a gear as long as **D** or **R** flashes.

If neither the accelerator nor the brake pedal are depressed, no gear is engaged and **D** or **R** flashes for a brief time in the display.

Stopping the vehicle

In **D**, first gear is engaged and the clutch is released when the vehicle is stopped. In **R**, reverse gear remains engaged.

Engine braking

Automatic mode

When driving downhill, the manual transmission automated does not shift into higher gears until a fairly high engine speed has been reached. It shifts down in good time when braking.

Manual mode

To utilise the engine braking effect, select a lower gear in good time when driving downhill. Changing into manual mode is only possible while the engine is running or during an Autostop.

Rocking the vehicle

Rocking the vehicle is only permissible if the vehicle is stuck in sand, mud or snow. Move the selector lever between **R** and **D** in a repeat pattern. Do not race the engine and avoid sudden acceleration.

Parking

The most recently engaged gear (see transmission display) remains engaged when switching off ignition. With **N**, no gear is engaged.

Therefore always apply the parking brake when switching off ignition. If parking brake is not applied, **P** flashes in the transmission display and the key cannot be removed from the ignition switch. **P** stops flashing in the transmission display as soon as the parking brake is slightly applied.

When the ignition is switched off, the transmission no longer responds to movement of the selector lever.

Tyre pressure monitoring system

To start the sensor matching process of the tyre pressure monitoring system, the selector lever must be moved and held in position **N** for five seconds. **P** illuminates in the transmission display to indicate that the sensor matching process can be started.

Tyre pressure monitoring system
⇨ 189.

Manual mode

If a higher gear is selected when the engine speed is too low, or a lower gear when the speed is too high, the shift is not executed. This prevents the engine from running at too low or too high an engine speed. A warning message is displayed in the Driver Information Centre. Vehicle messages ⇨ 99.

If engine speed is too low, the transmission automatically shifts to a lower gear.

If engine speed is too high, the transmission only switches to a higher gear via kickdown.

When **+** or **-** is selected in automatic mode, the transmission switches to manual mode and shifts accordingly.

Gear shift indication

The symbol ▲, with a number alongside it, is indicated when gearshifting is recommended for fuel saving reasons.

Shift indication appears only in manual mode.

Electronic driving programmes

- Following a cold start, the operating temperature programme increases engine speed to quickly bring the catalytic converter to the required temperature.
- The adaptive programme tailors gearshifting to the driving conditions, e.g. greater load or gradients.

Kickdown

If the accelerator pedal is pressed down completely in automatic mode, the transmission shifts to a lower gear depending on engine speed.

Fault

To prevent damage to the manual transmission automated, the clutch is engaged automatically at high clutch temperatures.

In the event of a fault, control indicator  illuminates. Additionally, a warning message is displayed in the Driver Information Centre. Vehicle messages ⇨ 99.

Continued driving is restricted or not possible, depending on the fault.

Have the cause of the fault remedied by a workshop.

Brakes

The brake system comprises two independent brake circuits.

If a brake circuit fails, the vehicle can still be braked using the other brake circuit. However, braking effect is achieved only when the brake pedal is depressed firmly. Considerably more force is needed for this. The braking distance is extended. Seek the assistance of a workshop before continuing the journey.

When the engine is not running, the support of the brake servo unit disappears once the brake pedal has been depressed once or twice.

Braking effect is not reduced, but braking requires significantly greater force. It is especially important to bear this in mind when being towed.

Control indicator  ⇨ 89.

Antilock brake system

Antilock brake system (ABS) prevents the wheels from locking.

ABS starts to regulate brake pressure as soon as a wheel shows a tendency to lock. The vehicle remains steerable, even during hard braking.

ABS control is made apparent through a pulse in the brake pedal and the noise of the regulation process.

For optimum braking, keep the brake pedal fully depressed throughout the braking process, despite the fact that the pedal is pulsating. Do not reduce the pressure on the pedal.

After starting off the system performs a self-test which may be audible.

Control indicator  ⇨ 90.

Adaptive brake light

During full braking, all three brake lights flash for the duration of ABS control.

Fault

⚠ Warning

If there is a fault in the ABS, the wheels may be liable to lock due to braking that is heavier than normal. The advantages of ABS are no longer available. During hard braking, the vehicle can no longer be steered and may swerve.

Have the cause of the fault remedied by a workshop.

Parking brake

Manual parking brake

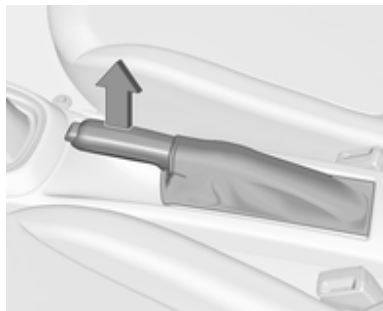
**⚠ Warning**

Always apply parking brake firmly without operating the release button, and apply as firmly as possible on a downhill or uphill slope.

To release the parking brake, pull the lever up slightly, press the release button and fully lower the lever.

To reduce the operating forces of the parking brake, depress the brake pedal at the same time.

Control indicator (D) ⇨ 89.

Brake assist

If the brake pedal is depressed quickly and forcefully, maximum brake force is automatically applied (full braking).

Maintain steady pressure on the brake pedal for as long as full braking is required. Maximum brake force is automatically reduced when the brake pedal is released.

Hill start assist

The system helps prevent unintended movement when driving away on inclines.

When releasing the brake pedal after stopping on an incline, the brakes remain on for a further two seconds. The brakes release automatically as

soon as the vehicle begins to accelerate or the two seconds holding time is over.

The hill start assist is not active during an Autostop.

Ride control systems

Traction Control system

The Traction Control system (TC) is a component of the Electronic Stability Control (ESC).

TC improves driving stability when necessary, regardless of the type of road surface or tyre grip, by preventing the drive wheels from spinning.

As soon as the drive wheels starts to spin, engine output is reduced and the wheel spinning the most is braked individually. This considerably improves the driving stability of the vehicle on slippery road surfaces.

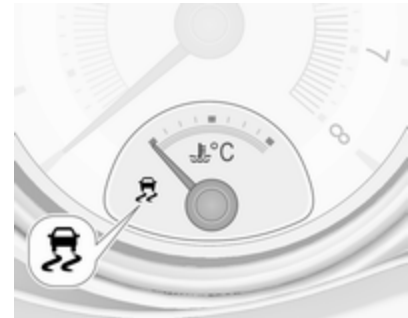

TC is operational after each engine start as soon as control indicator  extinguishes.

When TC operates  flashes.

Warning

Do not let this special safety feature tempt you into taking risks when driving.

Adapt speed to the road conditions.

Deactivation



TC can be switched off when spinning of drive wheels is required: press  briefly.

A status message appears in the Driver Information Centre when TC is deactivated.

When TC is deactivated, ESC remains active.

TC is reactivated by pressing  again. A status message pops up in the Driver Information Centre when TC is reactivated.

TC is also reactivated the next time the ignition is switched on.

Fault

If there is a fault in the system the control indicator  illuminates continuously and a message or a warning code appears in the Driver Information Centre. The system is not operational.

Have the cause of the fault remedied by a workshop.

Electronic Stability Control

Electronic Stability Control (ESC) improves driving stability when necessary, regardless of the type of road surface or tyre grip.

As soon as the vehicle starts to swerve (understeer/oversteer), engine output is reduced and the wheels are braked individually.

ESC operates in combination with the Traction Control system (TC). It prevents the drive wheels from spinning.



ESC is operational after each engine start as soon as control indicator  extinguishes.

When ESC operates  flashes.

Warning

Do not let this special safety feature tempt you into taking risks when driving.



Adapt speed to the road conditions.

Control indicator  \Rightarrow 90.

Deactivation



ESC and TC can be deactivated:

- hold  pressed for a minimum of five seconds: ESC and TC are both deactivated.  illuminates and status messages appear in the Driver Information Centre.

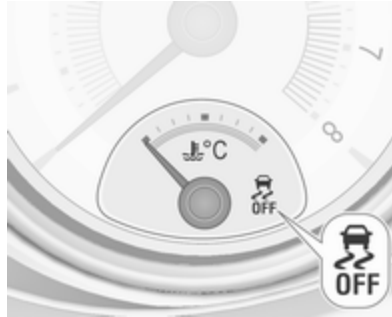

- To deactivate only Traction control system press  briefly: TC is inactive but ESC remains active. A status message appears in the Driver Information Centre when TC is deactivated.

If the vehicle reaches the stability threshold with deactivated ESC, the system will automatically reactivate ESC for the time duration of the threshold, when the brake pedal is depressed once.

ESC is reactivated by pressing  again. If the TC system was previously disabled, both TC and ESC are reactivated. A status message pops up in the Driver

Information Centre and  extinguishes when TC and ESC are reactivated.

ESC is also reactivated the next time the ignition is switched on.

Fault

If there is a fault in the system the control indicator  illuminates continuously and a message or a warning code appears in the Driver Information Centre. The system is not operational.

Have the cause of the fault remedied by a workshop.

City mode

City mode is a feature which enables increased steering assistance during lower speed conditions, e.g. city traffic or parking. Steering assistance is increased for greater convenience.

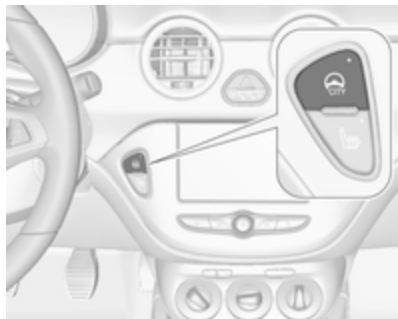
Activation

Press  when engine is running. The system works from standstill up to 35 km/h, and in reverse gear. Above this speed the system changes to normal mode. When activated, City mode engages automatically below 35 km/h.

An illuminated LED in the City mode button indicates that the system is active.

Additionally, a message pops-up in the Driver Information Centre.

City mode remains active during an Autostop, but is only operational when the engine is running.

Stop-start system  131.

Deactivation

Press ; LED in the button extinguishes and a message pops-up in the Driver Information Centre.



Each time the engine is started, City mode is deactivated.



Fault

In the event of a fault in the system,  illuminates and a message is displayed in the Driver Information Centre.

Vehicle messages  99.

System calibration

If control indicators  and  illuminate simultaneously, a calibration of the power steering system is necessary. This can occur e.g. when turning the steering wheel for one rotation with ignition switched off. In this case switch on ignition and turn steering wheel once from lock to lock.

If control indicators  and  do not extinguish after calibration, seek the assistance of a workshop.

Driver assistance systems

⚠ Warning

Driver assistance systems are developed to support the driver and not to replace the driver's attention.

The driver accepts full responsibility when driving the vehicle.

When using driver assistance systems, always take care regarding the current traffic situation.

Cruise control

The cruise control can store and maintain speeds of approx. 30 km/h to maximum vehicle speed. Deviations from the stored speeds may occur when driving uphill or downhill.

For safety reasons the cruise control cannot be activated until the brake pedal has been operated once. Activating in first gear is not possible.





Do not use the cruise control if it is not advisable to maintain a constant speed.

On vehicles with manual transmission automated cruise control can be activated in automatic mode and manual mode.

Control indicator   92.

Switching on

Press ; control indicator  in instrument cluster illuminates white.

Activation

Accelerate to the desired speed and turn thumb wheel to **SET/-**, the current speed is stored and maintained. Control indicator  in instrument cluster illuminates green. Accelerator pedal can be released.

Vehicle speed can be increased by depressing the accelerator pedal. When the accelerator pedal is released, the previously stored speed is resumed.

Cruise control remains activated while gearshifting.

Increase speed

With cruise control active, hold thumb wheel turned to **RES/+** or briefly turn to **RES/+** repeatedly: speed increases continuously or in small increments.

Alternatively accelerate to the desired speed and store by turning to **SET/-**.

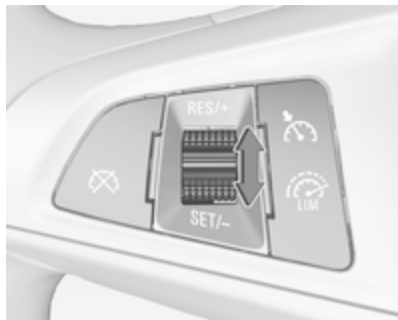

Reduce speed

With cruise control active, hold thumb wheel turned to **SET/-** or briefly turn to **SET/-** repeatedly: speed decreases continuously or in small increments.

Deactivation

Press ; control indicator in instrument cluster illuminates white. Cruise control is deactivated. Last stored speed remains in memory for later speed resume.

Automatic deactivation:

- Vehicle speed is below approx. 30 km/h.
- Vehicle speed drops more than 25 km/h below the set speed.
- The brake pedal is depressed.
- The clutch pedal is depressed for a few seconds.
- The selector lever is in **N**.
- Engine speed is in a very low range.
- The Traction Control system or Electronic Stability Control is operating.
- Simultaneous pressing **RES/+** and brake pedal deactivates cruise control and will delete stored speed.

Resume stored speed

Turn thumb wheel to **RES/+** at a speed above 30 km/h. The stored speed will be obtained.

Switching off

Press ; control indicator in instrument cluster extinguishes. The stored speed is deleted.

Pressing to activate the speed limiter or switching off the ignition also switches off cruise control and deletes the stored speed.

Speed limiter

The speed limiter prevents the vehicle exceeding a preset maximum speed.



The maximum speed can be set at speeds above 25 km/h up to 200 km/h.

The driver can only accelerate up to the preset speed. Deviations from the limited speed may occur when driving downhill.

The preset speed limit is displayed in the Driver Information Centre when the system is active.

Activation



Press . If cruise control has been activated before, it is switched off when speed limiter is activated and the control indicator  extinguishes.

Set speed limit

Accelerate to the desired speed and briefly turn thumb wheel to **SET/-**: the current speed is stored as maximum speed. Speed limit is displayed in the Driver Information Centre.

	50 km/h
	2781.2 km
	6.5 $\frac{L}{100km}$
	99.6 km/h
10253	

Change speed limit

With speed limiter active, turn thumb wheel to **RES/+** to increase or **SET/-** to decrease the desired maximum speed.

Exceeding the speed limit

When exceeding the limited speed without driver input, the speed will flash in the Driver Information Centre and a chime sounds during this period.

In the event of an emergency, it is possible to exceed the speed limit by depressing the accelerator pedal firmly nearly to the final point. In this case no chime appears.

Release the accelerator pedal and the speed limiter function is reactivated once a speed lower than the limit speed is obtained.

Deactivation

Press : speed limiter is deactivated and the vehicle can be driven without speed limit.

The stored limited speed is indicated in brackets in the Driver Information Centre.

Additionally, a corresponding message appears on the Uplevel-Display.

Resume limit speed

Turn thumb wheel to **RES/+**. The stored speed limit will be obtained and is indicated without brackets in the Driver Information Centre.

Switching off

Press , the speed limit indication in the Driver Information Centre extinguishes. The stored speed is deleted.

By pressing  to activate cruise control, speed limiter is also deactivated and the stored speed is deleted.

By switching off the ignition, speed limiter is also deactivated, but the speed limit will be stored for next speed limiter activation.

Parking assist

General information

When the trailer hitch is attached, change the configuration settings in the vehicle personalisation menu in the Info-Display. Vehicle personalisation ⇨ 102.

When attaching a trailer or bike carrier to the trailer hitch, the parking assist is deactivated.

Rear parking assist

Warning

It is the driver who bears full responsibility for the parking manoeuvre.

Always check the surrounding area while reversing and using the rear parking assist system.

The rear parking assist makes parking easier by measuring the distance between the vehicle and rear obstacles. It informs and warns the driver via acoustic and visual signals.

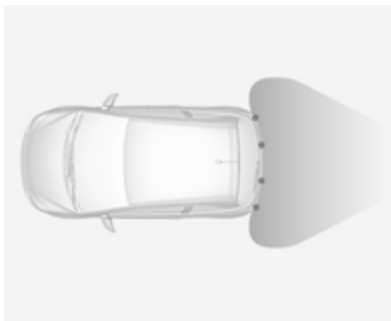

The system has four ultrasonic parking sensors in the rear bumper.

Activation

When reverse gear is engaged, the system is ready to operate automatically.

An illuminated LED in the parking assist button  indicates that the system is ready to operate.

Indication

The system warns the driver with acoustic signals against potentially hazardous obstacles behind the vehicle in a distance range up to 1.5 metres. The interval between the sounds becomes shorter as the vehicle gets closer to that obstacle. When the distance is less than approximately 30 cm, the sound is continuous.

Additionally, the distance to rear obstacles is displayed by changing distance lines in the Driver Information Centre with Uplevel display ⇨ 92 or, depending on the version, on the Colour-Info-Display ⇨ 97.

Deactivation



The system automatically switches off when reverse gear is disengaged. Manual deactivation is also possible by pressing **PWA**.

In both cases the LED in the button extinguishes.

Fault

In the event of a fault or if the system does not work temporarily, e.g. because of high external noise level or other interference factors, the LED in the button flashes for three seconds and then extinguishes. Control indicator **PWA** illuminates in

the instrument cluster ⇨ 90 and a message pops-up in the Driver Information Centre.

Front-rear parking assist

⚠ Warning

The driver bears full responsibility for the parking manoeuvre.

Always check the surrounding area when driving backwards or forwards while using parking assist system.

The front-rear parking assist measures the distance between the vehicle and obstacles in front and behind the vehicle. It informs and warns the driver via acoustic signals and display indication.

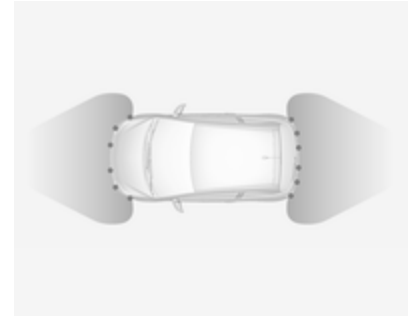

The system has six ultrasonic parking sensors in both the rear and front bumper.

It uses two different acoustic warning signals for the front and rear monitoring areas, each with a different tone frequency.

Front-rear parking assist is always combined with advanced parking assist, see "Advanced parking assist" section below.

Parking assist button and operation logic



Front-rear parking assist and advanced parking assist both use the same button for activation and deactivation:

A brief press of  activates or deactivates the parking assist.

A long press of  (approx. one second) activates or deactivates the advanced parking assist, see separate description.

Button logic operates the systems by pressing  as follows:

- If only front-rear parking assist is active, a brief press deactivates front-rear parking assist.
- If only front-rear parking assist is active, a long press activates advanced parking assist.
- If only advanced parking assist is active and the system is in parking slot searching mode, a brief press activates front-rear parking assist.
- If only advanced parking assist is active and the system is in park guiding mode, a brief press deactivates advanced parking assist.
- If advanced parking assist is active, a long press deactivates advanced parking assist and front-rear parking assist.

- If a forward gear or neutral is selected, a brief press activates or deactivates only front parking assist.
- If reverse gear is selected, a brief press activates or deactivates front and rear parking assist.

Activation

The system is activated automatically at a speed up to 11 km/h.

An illuminated LED in the parking assist button  indicates that the system is ready to operate.

If  is switched off within an ignition cycle, the front parking assist is deactivated. If vehicle speed has exceeded 25 km/h beforehand, parking assist will be reactivated when speed drops below 11 km/h.

When the system is deactivated, the LED in the button extinguishes and **Park Assist Off** pops-up in the Driver Information Centre.

Indication

The system warns the driver with acoustic signals against potentially hazardous obstacles in front of the

vehicle in a distance range up to 80 cm and against potentially hazardous obstacles behind the vehicle in a distance range up to 1.5 metres.

Depending on which side of the vehicle is closer to an obstacle, you will hear acoustic warning signals in the vehicle on the respective side. The interval between the sounds becomes shorter as the vehicle gets closer to that obstacle. When the distance is less than approx. 30 cm, the sound is continuous.

Additionally, the distance to obstacles is shown in the Driver Information Centre with Uplevel display ↗ 92 or, depending on the version, on the Colour-Info-Display ↗ 97.



The distance to a front and rear obstacle is displayed by changing distance lines in the Driver Information Centre.

The distance indication can be inhibited by vehicle messages with a higher priority. After dismissing the message distance indication appears again.



The distance to obstacles is shown on the Colour-Info-Display by coloured zones in front of or behind the vehicle ↗ 97.

Deactivation

The system is deactivated automatically when vehicle speed exceeds 11 km/h.

Manual deactivation is also possible by pressing the parking assist button



When the system is deactivated, the LED in the button extinguishes and, if manually deactivated, **Park Assist Off** pops-up in the Driver Information Centre.

After a manual deactivation, the front-rear parking assist is activated again if  is pressed.

The complete system can be manually deactivated in the vehicle personalisation menu in the Info-Display. It remains deactivated during the ignition cycle or until activated in personalisation menu again. Vehicle personalisation ⇨ 102.

Fault

In the event of a fault or if the system does not work temporarily, e.g. because of high external noise level or other interference factors, a message pops-up in the Driver Information Centre.

Vehicle messages ⇨ 99.

Advanced parking assist

Warning

The driver bears full responsibility for accepting the parking slot suggested by the system and the parking manoeuvre.

Always check the surrounding area in all directions when using the advanced parking assist.

The advanced parking assist measures a suitable parking slot while passing, calculates the trajectory and automatically steers the vehicle into a parallel or perpendicular parking slot.

Instructions are given in the Driver Information Centre ⇨ 92 or, depending on the version, on the Colour-Info-Display ⇨ 97, supported by acoustic signals.

The driver must control acceleration, braking and gearshifting, while steering is done automatically.

Advanced parking assist can only be activated when driving forwards.

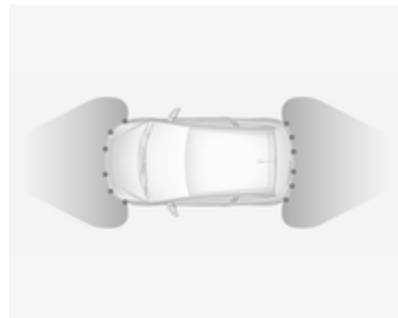



Advanced parking assist is always combined with front-rear parking assist, see previous section. Both systems use the same sensors in the front and rear bumper.

Button and operation logic

Advanced parking assist and front-rear parking assist both use the same button for activation and deactivation:

A brief press of  activates or deactivates the parking assist.

A long press of  (approx. one second) activates or deactivates the advanced parking assist, see separate description below.

Button logic operates the systems by pressing  as follows:

- If only front-rear parking assist is active, a brief press deactivates front-rear parking assist.
- If only front-rear parking assist is active, a long press activates advanced parking assist.
- If only advanced parking assist is active and the system is in parking slot searching mode, a brief press activates front-rear parking assist.
- If only advanced parking assist is active and the system is in park guiding mode, a brief press deactivates advanced parking assist.
- If advanced parking assist is active, a long press deactivates advanced parking assist and front-rear parking assist.

- If forward gear or neutral is selected, a brief press activates or deactivates front parking assist.
- If reverse gear is selected, a brief press activates or deactivates front and rear parking assist.

Activation



When searching for a parking slot, the system is ready to operate with a long press of .

The system recognises and memorises ten metres for parallel parking slots or six metres for perpendicular parking slots in the parking assist mode.

The system can only be activated at a speed up to 30 km/h and the system searches for a parking slot at a speed up to 30 km/h.

The maximum allowed parallel distance between the vehicle and a row of parked cars is 1.8 metres for parallel parking and 2.5 metres for perpendicular parking.

Functionality

Parking slot searching mode
Indication in the Driver Information Centre

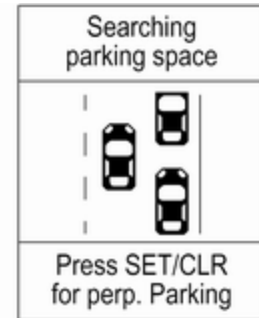



Select parallel or perpendicular parking slot in Driver Information Centre by pressing **SET/CLR**.

The system is configured to detect parking slots by default on the passenger side. To detect parking slots on the driver side, switch on turn signal indicator on the driver side.

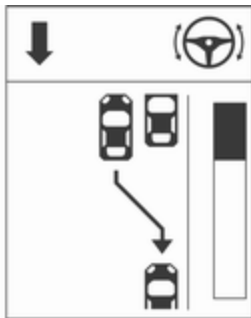

When a slot is detected, visual feedback in the Driver Information Centre and an acoustic signal are given.

Indication in the Colour-Info-Display



Select parallel or perpendicular parking slot by tapping the respective icon on the display.

Select parking side by tapping the respective icon on the display.

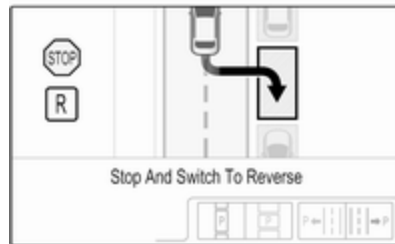

When a slot is detected, visual feedback on the Colour-Info-Display and an acoustic signal are given.

If the driver does not stop the vehicle after a parking slot is proposed, the system starts to search for another suitable parking slot.

Park guiding mode

The parking slot suggestion of the system is accepted when the vehicle is stopped by the driver within ten

metres for parallel parking slots or six metres for perpendicular parking slots after the **Stop** message is given. The system calculates the optimal path into the parking slot.

A brief vibration in the steering wheel after engaging reverse gear indicates that the steering is controlled by the system. Then the vehicle is steered into the slot automatically by giving the driver detailed instructions for braking, accelerating and gearshifting. The driver must keep hands away from the steering wheel.

Always pay attention to the sound of the front-rear parking assist. Continuous sound indicates that the distance to an obstacle is less than approx. 30 cm.

If, for any reason, the driver must take over control of the steering, hold the steering wheel only at the outer edge. Automatic steering is cancelled in this event.

Display indication

The instructions in the display show:

- general hints and warning messages
- a hint when driving faster than 30 km/h during parking slot searching mode, or 8 km/h in guiding mode
- the demand to stop the vehicle, when a parking slot is detected
- the direction of driving during the parking manoeuvre
- the demand to gearshift rearwards or forwards
- the demand to accelerate or brake
- for some of the instructions a progress bar is shown in the Driver Information Centre
- successful parking manoeuvre indicated by a pop-up symbol and a chime
- the cancelling of a parking manoeuvre

Display priorities

Advanced parking assist indication on the Driver Information Centre can be inhibited by vehicle messages with a higher priority. After approving the message by pressing **SET/CLR** on the turn signal lever, advanced parking assist instructions appear again and the parking manoeuvre can be continued.

Deactivation

The system is deactivated by:

- a long press of 
- parking manoeuvre successfully ended
- driving faster than 30 km/h during parking slot search
- driving faster than 8 km/h during parking guidance
- driver interference on steering wheel detected
- exceeding the maximum number of gear changes: eight parking cycles when parallel parking or five cycles when perpendicular parking
- switching off the ignition

Deactivation by the driver or by the system during manoeuvring will be indicated by **Parking Deactivated** on the display. Additionally, an acoustic signal sounds.

Fault

A message appears when:

- there is a fault in the system
- the driver did not successfully complete the parking manoeuvre
- the system is not operational
- any of the deactivation reasons described above apply

If an object is detected during parking instructions, **Stop** is indicated on the display. Removing the object will resume the parking manoeuvre. If the object is not removed, the system will be deactivated. A long press of  will activate the system and search for a new parking slot.

Basic notes on parking assist systems

Warning

Under certain circumstances, various reflective surfaces on objects or clothing as well as external noise sources may cause the system to fail to detect obstacles.

Special attention must be paid to low obstacles which can damage the lower part of the bumper.

Caution

Performance of the system can be reduced when sensors are covered, e.g. by ice or snow.

Performance of the parking assist system can be reduced due to heavy loading.

Special conditions apply if there are taller vehicles in the vicinity (e.g. off-road vehicles, mini vans, vans). Object identification and

correct distance indication in the upper part of these vehicles cannot be guaranteed.

Objects with a very small reflection cross-section, e.g. objects of narrow size or soft materials, may not be detected by the system.

Parking assist systems do not detect objects outside the detection range.

Note

It is possible that the sensor detects a non-existing object caused by echo disturbance from external acoustic noise or mechanical misalignments (sporadic false warnings may occur).

Make sure that the front number plate is properly mounted (not bent and no gaps to the bumper on the left or right side) and the sensors are firmly in place.

Advanced parking assist system may not respond to changes in the available parking space after initiating a parking manoeuvre. The system may recognize an entry, a

gateway, a courtyard or even a crossing as a parking slot. After selecting reverse gear the system will start a parking manoeuvre. Take care regarding the availability of the suggested parking slot.

Surface irregularities, e.g. on construction zones, are not detected by the system. The driver accepts responsibility.

Note

If engaging a forward gear and exceeding a certain speed, the parking assist will be deactivated when the rear carrier system is extended.

If engaging reverse for the first time, the parking assist will detect the rear carrier system and provide a buzzing sound. Press **P** with the parking assist icon or **DISP** with the parking assist icon briefly to deactivate the parking assist.

Note

After production, the system requires a calibration. For optimal parking guidance, a driving distance of at least 10 km, including a number of bends, is required.

Side blind spot alert

The Side blind spot alert system detects and reports objects on either side of the vehicle, within a specified "blind spot" zone. The system displays a visual alert in each exterior mirror, when detecting objects that may not be visible in the interior and exterior mirrors.

Side blind spot alert uses some of the advanced parking assist sensors which are located in the front and rear bumper on both sides of the vehicle.



⚠ Warning

Side blind spot alert does not replace driver vision.

The system does not detect:

- Vehicles outside the side blind zones which may be rapidly approaching.
- Pedestrians, cyclists or animals.

Before changing a lane, always check all mirrors, look over the shoulder and use the turn signal.

When the system detects a vehicle in the side blind zone while driving forwards, either while passing a vehicle or being passed, a yellow warning symbol  will illuminate in the relevant exterior mirror. If the driver then activates the turn signal, the warning symbol  starts flashing yellow as a warning not to change lanes.

Note

If the overtaking vehicle is at least 10 km/h faster than the vehicle being overtaken, the warning symbol  in the relevant exterior mirror may not illuminate.

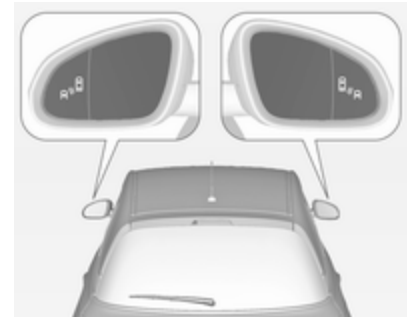

Side blind spot alert is active from speeds of 10 km/h up to 140 km/h. Driving faster than 140 km/h deactivates the system, indicated by low lighting warning symbols ^a^b in both exterior mirrors. Reducing the speed again will extinguish the warning symbols. If a vehicle is then detected in the blind zone, the warning symbols ^a^b will illuminate as normal on the relevant side.

When the vehicle is started, both exterior mirror displays will briefly illuminate to indicate that the system is operating.

The system can be activated or deactivated in the Info-Display. Vehicle personalisation ⇨ 102.

Deactivation is indicated by a message in the Driver Information Centre.

Detection zones

The detection zones start at the rear bumper and extend approx. three metres rearwards and to the sides. The height of the zone is between approx. 0.5 metres and two metres off the ground.

The system is deactivated if the vehicle is towing a trailer.

Side blind spot alert is designed to ignore stationary objects, e.g. guardrails, posts, curbs, walls and beams. Parked vehicles or oncoming vehicles are not detected.

Fault

Occasional missed alerts can occur under normal circumstances and will increase in wet conditions.

Side blind spot alert does not operate when the left or right corners of the rear bumper are covered with mud, dirt, snow, ice, slush, or in heavy rainstorms. Cleaning instructions ⇨ 209.

In the event of a fault in the system or if the system does not work due to temporary conditions, a message is displayed in the Driver Information Centre. Seek the assistance of a workshop.

Fuel

Fuel for petrol engines

Only use unleaded fuel that complies with European standard EN 228 or equivalent.

The engine is capable of running with fuel that contains up to 10% ethanol (e.g. named E10).

Use fuel with the recommended octane rating. A lower octane rating can reduce engine power and torque and slightly increases fuel consumption.

Caution
Do not use fuel or fuel additives that contain metallic compounds such as manganese-based additives. This may cause engine damage.

Caution

Use of fuel that does not comply to EN 228 or equivalent can lead to deposits or engine damage.

Caution

Use of fuel with a lower octane rating than the lowest possible rating could lead to uncontrolled combustion and engine damage.

The engine-specific requirements regarding octane rating are given in the engine data overview ↗ 222. A country-specific label at the fuel filler flap can supersede the requirement.

Fuel additives outside Europe

Fuel should contain detergent additives that help prevent engine and fuel system deposits from forming. Clean fuel injectors and intake valves will allow the emission control system to work properly.

Some fuel does not contain sufficient quantities of additive to keep fuel injectors and intake valves clean.

To make up for this lack of detergency, add Fuel System Treatment PLUS to the fuel tank at every engine oil change or every 15,000 km, whichever occurs first. It is available at your workshop.

Fuels containing oxygenates such as ethers and ethanol, as well as reformulated fuel, are available in some cities. If these fuels comply with the previously described specification, then they are acceptable to use. However, E85 (85% ethanol) and other fuels containing more than 15% ethanol must be used only in FlexFuel vehicles.

Caution

Do not use fuel containing methanol. It can corrode metal parts in the fuel system and also damage plastic and rubber parts. This damage would not be covered by the vehicle warranty.

Some fuels, mainly high octane racing fuels, can contain an octane enhancing additive called methylcyclopentadienyl manganese tricarbonyl (MMT). Do not use fuels or fuel additives with MMT as they can reduce spark plug life and affect emission control system performance. The malfunction indicator light  may turn on ↗ 89. If this occurs, seek the assistance of a workshop.

Fuel for liquid gas operation

Liquid gas is known as LPG (Liquefied Petroleum Gas) or under its French name GPL (Gaz de Pétrole Liquéfié). LPG is also known as Autogas.

LPG consists mainly of propane and butane. The octane rating is between 105 and 115, depending on the butane proportion. LPG is stored liquid at around five to ten bar pressure.

The boiling point depends on the pressure and mixing ratio. At ambient pressure, it is between -42 °C (pure propane) and -0.5 °C (pure butane).

Caution

The system works at an ambient temperature of approx. -8 °C to 100 °C.

Full function of the LPG system can only be guaranteed with liquid gas which complies with the minimum requirements of DIN EN 589.

Fuel selector ⇨ 82.

Refuelling

⚠ Danger

Before refuelling, switch off the ignition.

Follow the operating and safety instructions of the filling station when refuelling.

⚠ Danger

Fuel is flammable and explosive. No smoking. No naked flames or sparks.

If you can smell fuel in your vehicle, have the cause of this remedied immediately by a workshop.

Caution

In case of misfuelling, do not switch on ignition.

Fuel filler flap is located at right rear side of the vehicle.



The fuel filler flap can only be opened when the vehicle is unlocked. Push the flap to engage. Then open the flap.

Turn the fuel filler cap slowly anticlockwise to open.

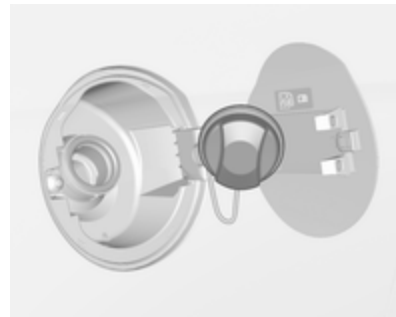

The fuel filler cap can be retained in the bracket on the fuel filler flap.

To refuel, fully insert the pump nozzle and switch it on.

After the automatic cut-off, the tank can be topped up by operating the pump nozzle a maximum of two more times.

Caution

Wipe off any overflowing fuel immediately.

To close, turn the fuel filler cap clockwise until it clicks.

Close the flap and allow it to engage.

Liquid gas refuelling

Follow the operating and safety instructions of the filling station when refuelling.

The filling valve for the liquid gas is behind the fuel filler cap.

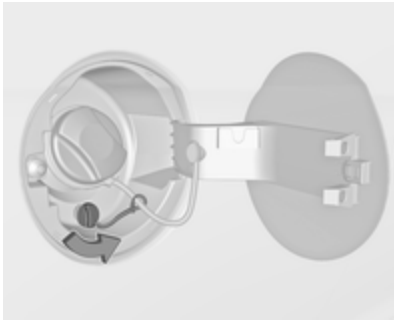

Unscrew protective cap from the filler neck.

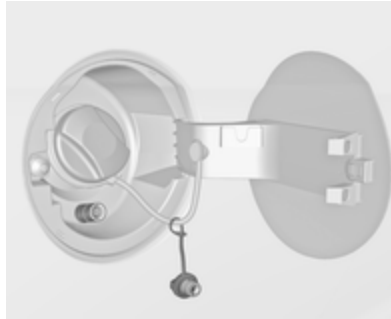

Screw the required adapter hand-tight onto the filler neck.

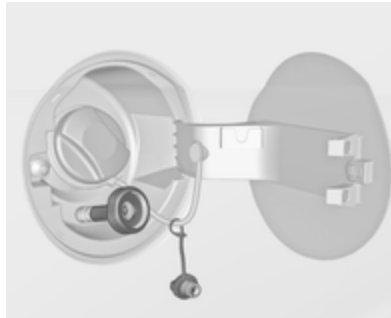

ACME Adapter: Screw the nut of the filling nozzle onto the adapter. Press locking lever on filler nozzle down.

DISH filler neck: Place the filler nozzle into the adapter. Press locking lever on filler nozzle down.

Bayonet filler neck: Place filler nozzle on the adapter and turn clockwise or anticlockwise through one quarter turn. Pull locking lever of filler nozzle fully.

EURO filler neck: Press the filler nozzle onto the adapter until it engages.

Press the button at the liquid gas supply point. The filling system stops or begins to run slowly when 80% of the tank volume is reached (maximum fill level).

Release button on filling system and the filling process stops. Release the locking lever and remove the filler nozzle. A small quantity of liquid gas may escape.

Remove adapter and stow securely in vehicle.

Fit protective cap to prevent the penetration of foreign bodies into the filler opening and the system.

⚠ Warning

Due to the system design, an escape of liquid gas after releasing the locking lever is unavoidable. Avoid inhaling.

⚠ Warning

The liquid gas tank should only be filled to 80% capacity, for safety reasons.

The multivalve on the liquid gas tank automatically limits the fill quantity. If a larger quantity is added, we recommend not exposing the vehicle to the sun until the excess amount has been used up.

Filling adapter

As filling systems are not standardised, different adapters are required which are available from Opel Distributors and from Opel Authorised Repairers.

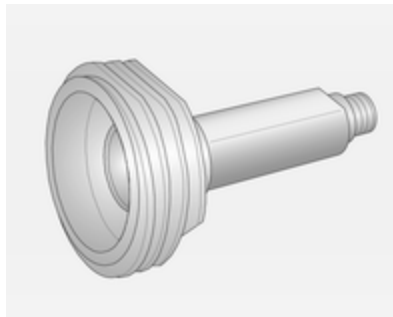

ACME adapter: Belgium, Germany, Ireland, Luxembourg, Switzerland

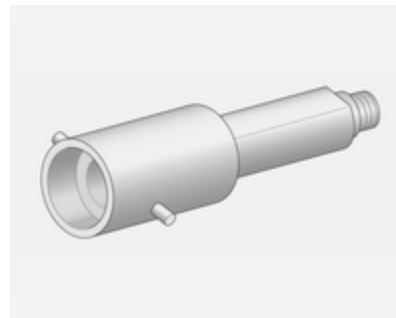

Bayonet adapter: Netherlands, Norway, Spain, United Kingdom

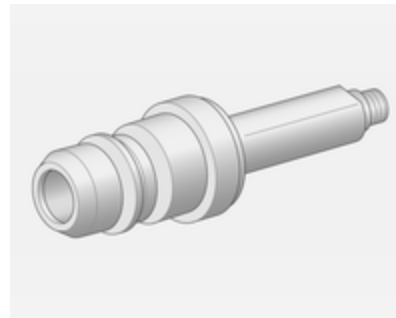

EURO adapter: Spain

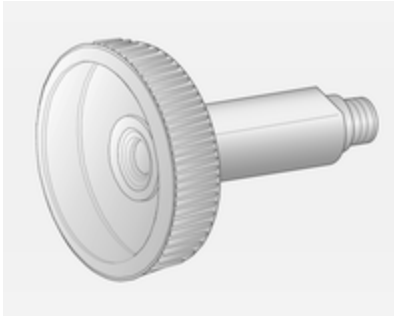

DISH adapter: Austria, Bosnia-Herzegovina, Bulgaria, Croatia, Czech Republic, Denmark, Estonia, France, Greece, Hungary, Italy, Latvia, Lithuania, Macedonia, Poland, Portugal, Romania, Serbia, Slovakia, Slovenia, Sweden, Switzerland, Turkey, Ukraine

Fuel filler cap

Only use genuine fuel filler caps.

Fuel consumption - CO₂-Emissions

The fuel consumption (combined) of the model Opel Adam is within a range of 6.7 to 4.3 l/100 km.

The CO₂ emission (combined) is within a range of 139 to 99 g/km.

For the values specific for your vehicle, refer to the EEC Certificate of Conformity provided with your vehicle or other national registration documents.

General information

The official fuel consumption and specific CO₂ emission figures quoted relate to the EU base model with standard equipment.

Fuel consumption data and CO₂ emission data are determined according to regulation R (EC) No. 715/2007 (in the latest applicable version), taking into consideration the vehicle weight in running order, as specified by the regulation.

The figures are provided only for the purpose of comparison between different vehicle variants and must not be taken as a guarantee for the actual fuel consumption of a particular vehicle. Additional equipment may result in slightly higher results than the stated consumption and CO₂ figures. Furthermore, fuel consumption is dependent on personal driving style as well as road and traffic conditions.

Vehicle care

General Information	164
Accessories and vehicle modifications	164
Vehicle storage	165
End-of-life vehicle recovery	165
Vehicle checks	166
Performing work	166
Bonnet	166
Engine oil	167
Engine coolant	168
Washer fluid	168
Brakes	169
Brake fluid	169
Vehicle battery	169
Wiper blade replacement	171
Bulb replacement	171
Halogen headlights	171
Front turn signal lights	174
Tail lights	175
Side turn signal lights	179
Number plate light	179
Interior lights	180
Instrument panel illumination ...	180
Electrical system	181
Fuses	181

Engine compartment fuse box .	182
Instrument panel fuse box	184
Vehicle tools	186
Tools	186
Wheels and tyres	187
Winter tyres	187
Tyre designations	188
Tyre pressure	188
Tyre pressure monitoring system	189
Tread depth	193
Changing tyre and wheel size .	193
Wheel covers	193
Tyre chains	194
Tyre repair kit	194
Wheel changing	198
Spare wheel	201
Jump starting	205
Towing	206
Towing the vehicle	206
Towing another vehicle	208
Appearance care	209
Exterior care	209
Interior care	211

General Information

Accessories and vehicle modifications

We recommend the use of genuine parts and accessories and factory approved parts specific for your vehicle type. We cannot assess or guarantee reliability of other products - even if they have a regulatory or otherwise granted approval.

Any modification, conversion or other changes made to standard vehicle specifications (including, without limitation, software modifications, modifications of the electronic control units) may invalidate the warranty offered by Opel. Furthermore, such changes may affect driver assistance systems, fuel consumption, CO₂ emissions and other emissions of the vehicle. They may also invalidate the vehicle operating permit.

Caution
When transporting the vehicle on a train or on a recovery vehicle, the mud flaps might be damaged.

Vehicle storage

Storage for a long period of time

If the vehicle is to be stored for several months:

- Wash and wax the vehicle.
- Have the wax in the engine compartment and underbody checked.
- Clean and preserve the rubber seals.
- Fill up fuel tank completely.
- Change the engine oil.
- Drain the washer fluid reservoir.
- Check the coolant antifreeze and corrosion protection.
- Adjust tyre pressure to the value specified for full load.

- Park the vehicle in a dry, well ventilated place. Engage first or reverse gear. Prevent the vehicle from rolling.
- Do not apply the parking brake.
- Open the bonnet, close all doors and lock the vehicle.
- Disconnect the clamp from the negative terminal of the vehicle battery. Beware that all systems are not functional, e.g. anti-theft alarm system.

Putting back into operation

When the vehicle is to be put back into operation:

- Connect the clamp to the negative terminal of the vehicle battery. Activate the electronics of the power windows.
- Check tyre pressure.
- Fill up the washer fluid reservoir.
- Check the engine oil level.
- Check the coolant level.
- Fit the number plate if necessary.

End-of-life vehicle recovery

Information on end-of-life vehicle recovery centres and the recycling of end-of-life vehicles is available on our website. Only entrust this work to an authorised recycling centre.

Gas vehicles must be recycled by a service centre authorised for gas vehicles.

Vehicle checks

Performing work



⚠ Warning

Only perform engine compartment checks when the ignition is off.
The cooling fan may start operating even if the ignition is off.

⚠ Danger

The ignition system uses extremely high voltage. Do not touch.

Bonnet

Opening



Pull the release lever and return it to its original position.

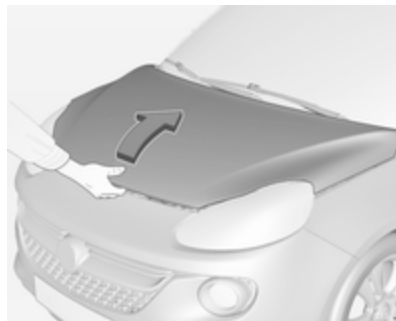

Push the safety catch upwards and open the bonnet.

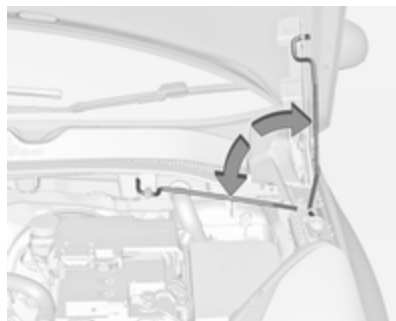

Secure the bonnet support.

If the bonnet is opened during an Autostop, the engine will be restarted automatically for safety reasons.

Closing

Before closing the bonnet, press the support into the holder.

Lower the bonnet and allow it to fall into the latch from a low height (20-25 cm). Check that the bonnet is engaged.

Caution

Do not press the bonnet into the latch, to avoid dents.

Engine oil

Check the engine oil level manually on a regular basis to prevent damage to the engine. Ensure that the correct specification of oil is used.

Recommended fluids and lubricants
 ⇨ 214.

The maximum engine oil consumption is 0.6 l per 1000 km.

Check with the vehicle on a level surface. The engine must be at operating temperature and switched off for at least five minutes.

Pull out the dipstick, wipe it clean, reinsert it fully, pull out and read the engine oil level.

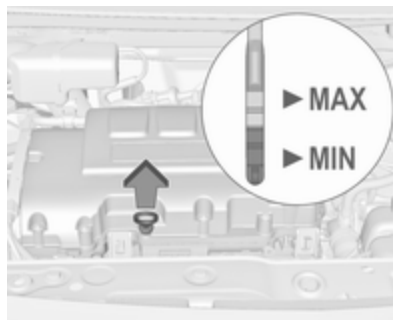

When the engine oil level has dropped to the **MIN** mark, top up engine oil.

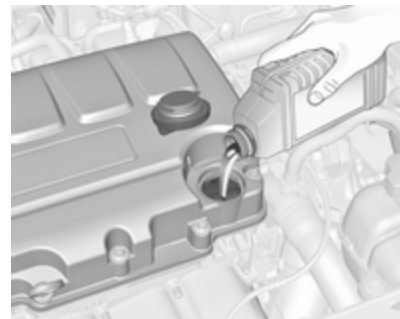

We recommend the use of the same grade of engine oil that was used at last change.

The engine oil level must not exceed the **MAX** mark on the dipstick.

Caution

Overfilled engine oil must be drained or suctioned out.

Capacities ⇨ 227.

Fit the cap on straight and tighten it.

Engine coolant

The coolant provides freeze protection down to approx. -28°C . In northern countries with very low temperatures the factory filled coolant provides frost protection down to approx. -37°C .

Caution

Only use approved antifreeze.

Coolant and antifreeze ↗ 214.

Coolant level

Caution

Too low a coolant level can cause engine damage.



If the cooling system is cold, the coolant level should be above the filling line mark. Top up if the level is low.

⚠ Warning

Allow the engine to cool before opening the cap. Carefully open the cap, relieving the pressure slowly.

To top up use a 1:1 mixture of released coolant concentrate mixed with clean tap water. If no coolant concentrate is available, use clean tap water. Install the cap tightly. Have

the coolant concentration checked and have the cause of the coolant loss remedied by a workshop.

Washer fluid



Fill with clean water mixed with a suitable quantity of approved windscreen washer fluid which contains antifreeze.

Caution

Only washer fluid with a sufficient antifreeze concentration provides protection at low temperatures or a sudden drop in temperature.

Washer fluid ⇨ 214.

Brakes

In the event of minimum thickness of the brake lining, a squealing noise sounds during braking.

Continued driving is possible but have the brake lining replaced as soon as possible.

Once new brake linings are installed, do not brake unnecessarily hard for the first few journeys.

Brake fluid

⚠ Warning

Brake fluid is poisonous and corrosive. Avoid contact with eyes, skin, fabrics and painted surfaces.

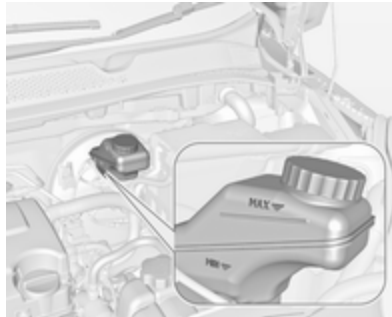

The brake fluid level must be between the **MIN** and **MAX** marks.

If fluid level is below **MIN** seek the assistance of a workshop.

Brake and clutch fluid ⇨ 214.

Vehicle battery

The vehicle battery is maintenance-free provided that the driving profile allows sufficient charging of the battery. Short-distance-driving and frequent engine starts can discharge the vehicle battery. Avoid the use of unnecessary electrical consumers.



Batteries do not belong in household waste. They must be disposed of at an appropriate recycling collection point.

Laying up the vehicle for more than four weeks can lead to vehicle battery discharge. Disconnect the clamp from the negative terminal of the vehicle battery.

Ensure the ignition is switched off before connecting or disconnecting the vehicle battery.

Battery discharge protection ⇨ 117.

Disconnecting the battery

If the vehicle's battery is to be disconnected (e.g. for maintenance work), the alarm siren must be deactivated as follows: Switch the ignition on then off, then disconnect the vehicle's battery within 15 seconds.

Replacing the vehicle battery

Note

Any deviation from the instructions given in this section may lead to temporary deactivation or disturbance of the stop-start system.

When the vehicle battery is being replaced, please ensure that there are no open ventilation holes in the vicinity of the positive terminal. If a ventilation hole is open in this area, it must be closed off with a dummy cap, and the ventilation in the vicinity of the negative terminal must be opened.

Ensure that the battery is always replaced by the same type of battery.

We recommend the use of an original Opel battery.

Note

Using an AGM vehicle battery different from the original Opel vehicle battery may result in a lower performance.

We recommend that you have the vehicle battery replaced by a workshop.

Charging the vehicle battery

⚠ Warning

On vehicles with stop-start system, ensure that the charging potential does not exceed 14.6 volts when using a battery charger. Otherwise the battery might be damaged.

Jump starting ⇨ 205.

Stop-start system ⇨ 131.

Warning label



Meaning of symbols:

- No sparks, naked flames or smoking.
- Always shield eyes. Explosive gases can cause blindness or injury.
- Keep the vehicle battery out of the reach of children.
- The vehicle battery contains sulfuric acid which could cause blindness or serious burn injuries.
- See the Owner's manual for further information.
- Explosive gas may be present in the vicinity of the battery.

Wiper blade replacement

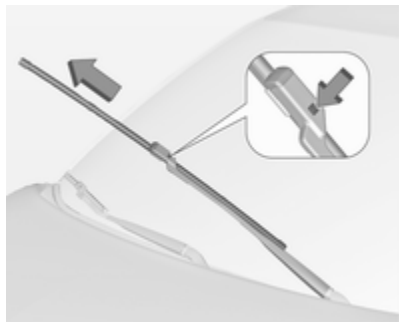

Lift the wiper arm until it stays in the raised position, press button to disengage the wiper blade and remove.

Attach the wiper blade slightly angled to the wiper arm and push until it engages.

Lower wiper arm carefully.

Wiper blade on the rear window



Lift wiper arm. Disengage wiper blade as shown in illustration and remove.

Attach the wiper blade slightly angled to the wiper arm and push until it engages.

Lower wiper arm carefully.

Bulb replacement

Switch off the ignition and switch off the relevant switch or close the doors. Only hold a new bulb at the base! Do not touch the bulb glass with bare hands.

Use only the same bulb type for replacement.

Replace headlight bulbs from within the engine compartment.

Bulb check

After a bulb replacement switch on the ignition, operate and check the lights.

Halogen headlights

Halogen headlights with separate bulbs for low beam and high beam.

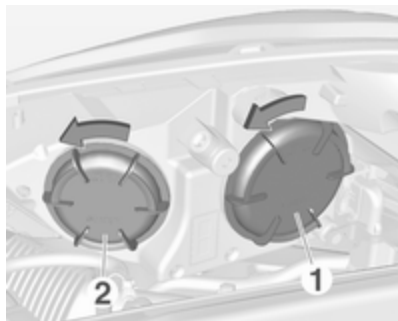

Low beam outer bulb (1).

High beam inner bulb (2).

Low beam (1)

1. Rotate the cap anticlockwise and remove it.



2. Press the clip to disengage bulb holder. Withdraw the bulb holder from the reflector.

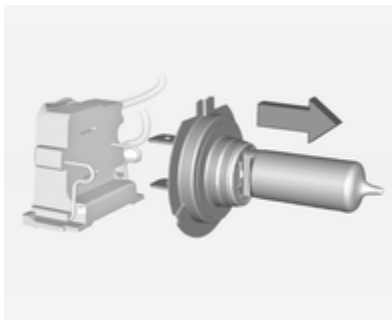

3. Detach the bulb from the bulb holder and replace the bulb.

4. Insert the bulb holder with the clip downwards and engage into the reflector until it clicks.

5. Install cap.

High beam (2)

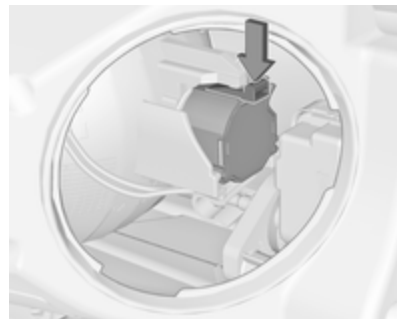

1. Rotate the cap anticlockwise and remove it.

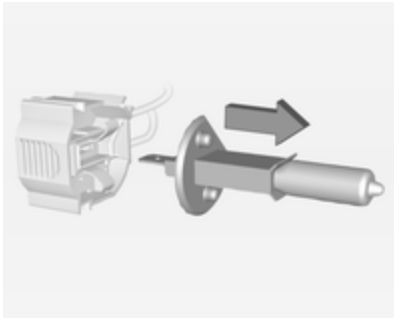

2. Press the clip to disengage bulb holder. Withdraw the bulb holder from the reflector.
3. Detach the bulb from the bulb holder and replace the bulb.
4. Insert the bulb holder with the clip upwards and engage into the reflector until it clicks.
5. Install cap.

Sidelight/Daytime running light with bulbs (3)

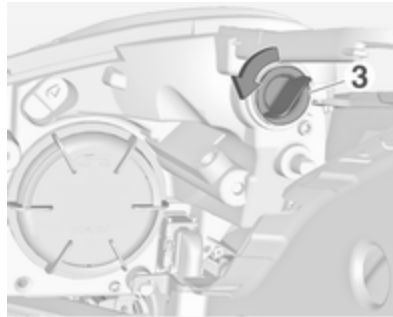

1. Rotate bulb socket (3) anticlockwise to disengage. Withdraw the bulb socket from the headlamp housing.

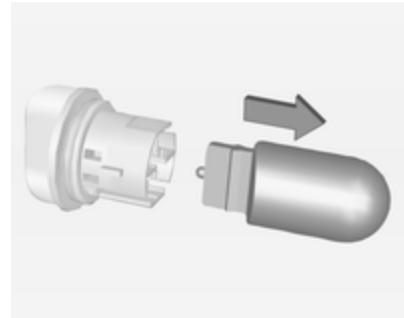

2. Remove the bulb from the socket by pulling.
3. Replace and insert new bulb into socket.
4. Insert the bulb socket into the headlamp housing and turn clockwise.

Sidelight/Daytime running light with LEDs

Sidelights and daytime running lights consist of LEDs which cannot be changed. Consult a workshop in case of a defective LED.

Front turn signal lights



1. Undo screw and remove cover.

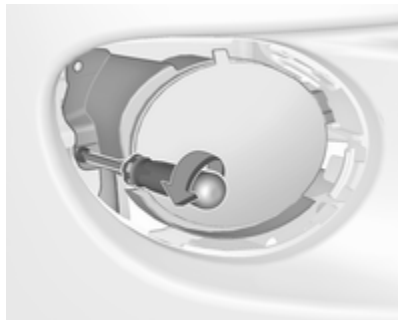

2. Undo screw and remove light assembly from the bumper.



3. Disengage and remove the bulb socket by turning anticlockwise.

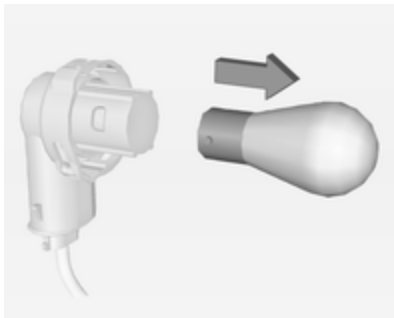

4. Remove bulb by turning anticlockwise slightly and withdrawing. Replace the bulb.

5. Insert the bulb socket into the assembly and turn clockwise.
6. Attach light assembly into the bumper and fix with the screw.
7. Insert cover into the bumper and fix with the screw.

Adam Rocks



1. Disengage the small cap with a screwdriver at the marked position.



2. Remove the cover by pulling with fingers at the marked positions, see arrows in the illustration.

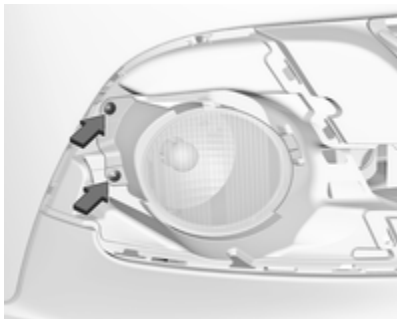

3. Undo both screws and remove light assembly from the bumper.



4. Disengage and remove the bulb socket by turning anticlockwise.

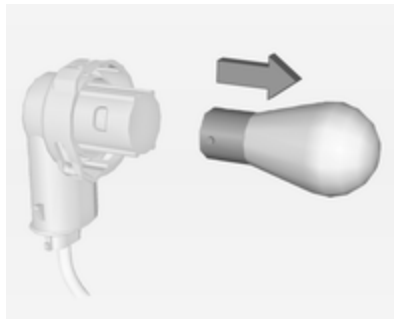

5. Remove bulb by turning anticlockwise slightly and withdrawing. Replace the bulb.

6. Insert the bulb socket into the assembly and turn clockwise.
 7. Attach light assembly into the bumper and fix with both screws.
 8. Insert and engage cover into the bumper. Insert small cap.

Tail lights

Versions with subwoofer box

Remove the load compartment floor cover. On right side also remove the tool box to gain access to the cover ↻ 67.

Versions with storage box

Remove storage box to gain access to the cover ↻ 65.



1. Release the cover on the respective side and remove.

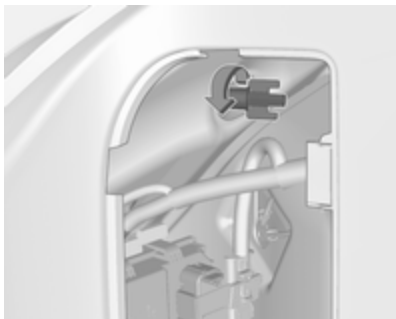

2. Unscrew the plastic securing nut from the inside by hand.

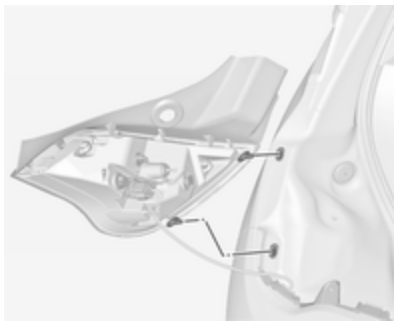

3. Carefully withdraw the light assembly from the recesses and remove.

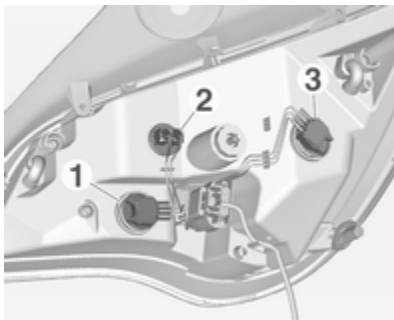

4. Turn bulb holder anticlockwise and remove. Replace bulb by withdrawing:
 turn signal light **1**
 tail light **2**
 tail light / brake light **3**
 If tail light **2** and tail light/brake light **3** are LEDs, seek the assistance of a workshop for replacement.

5. Insert and turn bulb holder clockwise into the tail light assembly. Ensure the wires remain in the cable ducts.



- Fit light assembly with the retaining pins into the recesses of

the vehicle body and tighten the plastic securing nut from inside the load compartment. Pull the circular gasket over the recess in the lamp housing.

Close cover and engage.

Reversing light/rear fog light

Left-hand drive vehicles

Reversing light is located on the right side of the bumper, and the rear fog light is located on the left side of the bumper.

Right-hand drive vehicles

Reversing light is located on the left side of the bumper, and the rear fog light is located on the right side of the bumper.

The description of bulb replacement is the same for both lights.



1. Undo screw and remove cover.



2. Undo screw and remove light assembly from the bumper.

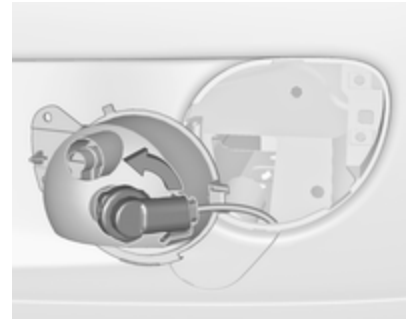

3. Disengage and remove the bulb socket by turning anticlockwise.

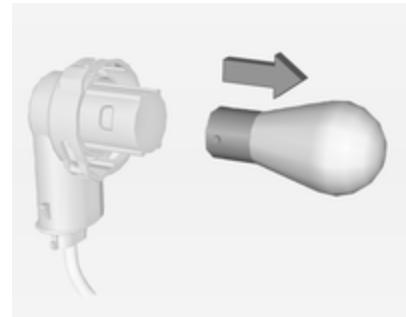

4. Remove bulb by turning anticlockwise slightly and withdrawing. Replace the bulb.

5. Insert the bulb socket into the assembly and turn clockwise.
6. Replace light assembly in the bumper and fix with the screw.
7. Insert cover into the bumper and fix with the screw.

Adam Rocks



1. Remove the cover by pulling by hand at the marked position, see arrow in the illustration.

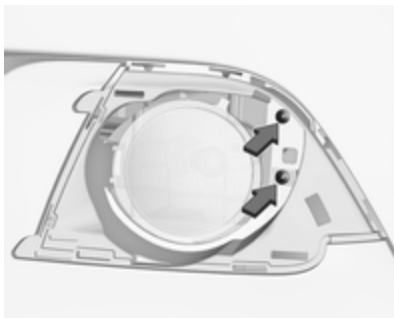

2. Undo both screws and remove light assembly from the bumper.

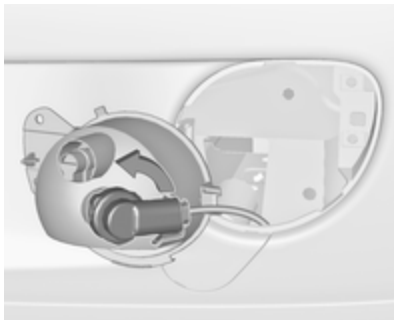

3. Disengage and remove the bulb socket by turning anticlockwise.

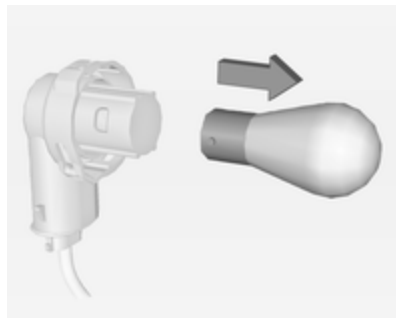

4. Remove bulb by turning anticlockwise slightly and withdrawing. Replace the bulb.
5. Insert the bulb socket into the assembly and turn clockwise.
6. Attach light assembly into the bumper and fix with both screws.
7. Insert and engage cover into the bumper.

Side turn signal lights

To replace bulb, remove lamp housing:

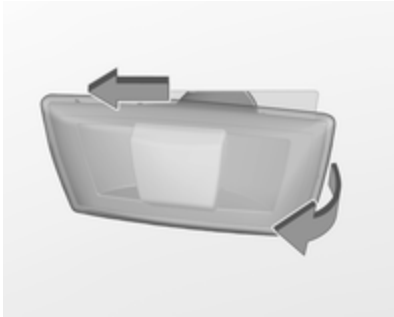

1. Slide lamp to its left side and remove with its right end.



2. Turn bulb holder anticlockwise and remove from housing.

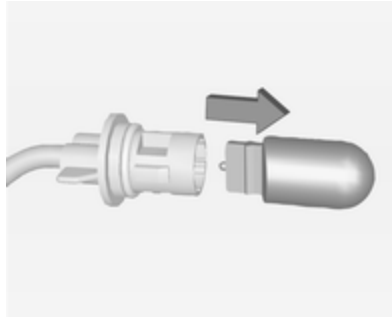

3. Pull bulb from bulb holder and replace it.

4. Insert bulb holder and turn clockwise.
5. Insert left end of the lamp, slide to the left and insert right end.

Number plate light

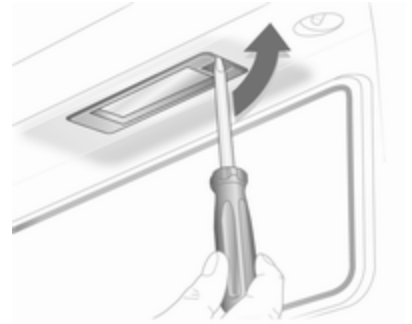

1. Insert screwdriver in recess of the cover, press to the side and release spring.



2. Remove lamp downwards, taking care not to pull on the cable.

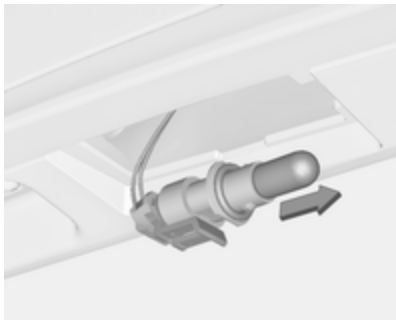

3. Remove bulb holder from lamp housing by turning anticlockwise.

4. Pull bulb from bulb holder and replace it.
5. Insert bulb holder into lamp housing and turn clockwise.
6. Insert lamp into bumper and allow it to engage.

Interior lights

Courtesy light, reading lights

Have bulbs replaced by a workshop.

Load compartment light

Have bulbs replaced by a workshop.

Dome light

Have bulbs replaced by a workshop.

Ambient light

Have bulbs replaced by a workshop.

Starlight panel

Have bulbs replaced by a workshop.

Instrument panel illumination

Have bulbs replaced by a workshop.

Electrical system

Fuses

Data on the replacement fuse must match the data on the defective fuse.

There are two fuse boxes in the vehicle:

- in the front left of the engine compartment,
- in left-hand drive vehicles behind the light switch, or, in right-hand drive vehicles, behind the glovebox.

Before replacing a fuse, turn off the respective switch and the ignition.

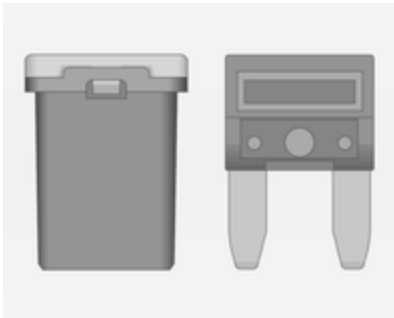

There are different kinds of fuses in the vehicle.



Depending on the type of fuse, a blown fuse can be recognized by its melted wire. Do not replace the fuse until the cause of the fault has been remedied.

Some functions are protected by several fuses.

Fuses may also be inserted without existence of a function.

Fuse extractor

A fuse extractor may be located in the fuse box in the engine compartment.

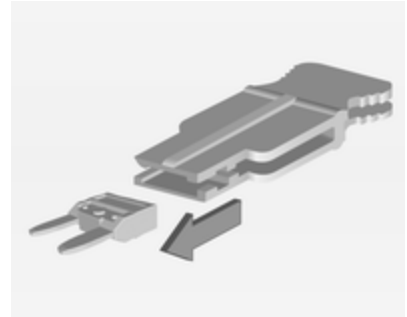

Place the fuse extractor on the various types of fuse from the top, and withdraw fuse.

Engine compartment fuse box



The fuse box is located at the front left of the engine compartment.

Disengage the cover and fold it upwards until it stops. Remove the cover vertically upwards.



No. Circuit

- | No. | Circuit |
|-----|--|
| 1 | – |
| 2 | Exterior mirror switch |
| 3 | Body control module |
| 4 | Foldable sunroof/Chassis control module |
| 5 | ABS |
| 6 | Daytime running light left |
| 7 | – |
| 8 | Body control module |
| 9 | Vehicle battery sensor |
| 10 | Headlamp levelling/TPMS/
Foldable sunroof |
| 11 | Rear wiper |
| 12 | Window defog |
| 13 | Daytime running light right |
| 14 | Mirror defog |
| 15 | – |

No. Circuit

- 16 Chassis control module/LPG system
- 17 Interior mirror
- 18 Engine control module
- 19 Fuel pump
- 20 –
- 21 Injection coil
- 22 –
- 23 Injection system
- 24 Washer system
- 25 Lighting system
- 26 Engine control module
- 27 –
- 28 Engine control module
- 29 Engine control module
- 30 –
- 31 Left headlamp

No. Circuit

- 32 Right headlamp
- 33 Engine control module
- 34 Horn
- 35 Clutch
- 36 –

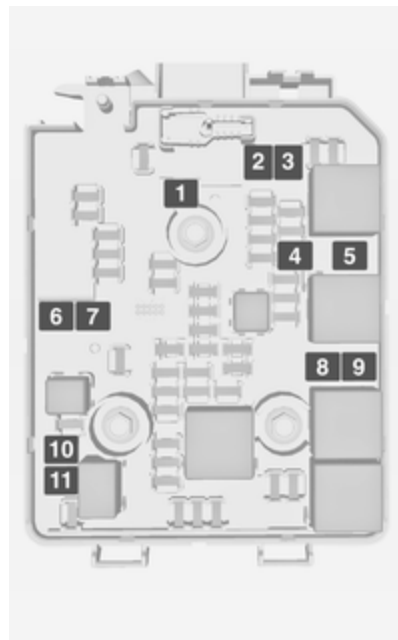

No. Circuit

- | | |
|----|------------------------|
| 1 | ABS pump |
| 2 | Front wiper |
| 3 | Blower |
| 4 | Instrument panel |
| 5 | Cooling fan |
| 6 | – |
| 7 | Electrical vacuum pump |
| 8 | Cooling fan |
| 9 | Cooling fan |
| 10 | – |
| – | |
| 11 | Starter |

After having changed defective fuses, close the fuse box cover and press until it engages.

If the fuse box cover is not closed correctly, malfunction may occur.

Instrument panel fuse box

Left-hand drive vehicles



The fuse box is behind the light switch in the instrument panel.

Hold the handle, then pull and fold down the light switch.

Right-hand drive vehicles

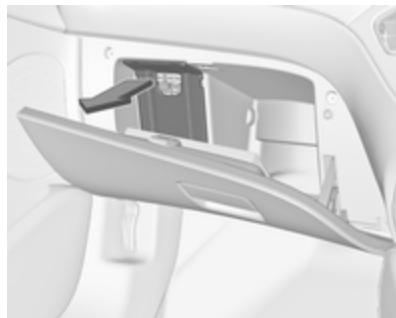

The fuse box is located behind a cover in the glovebox. Open the glovebox, then open the cover and fold it down.

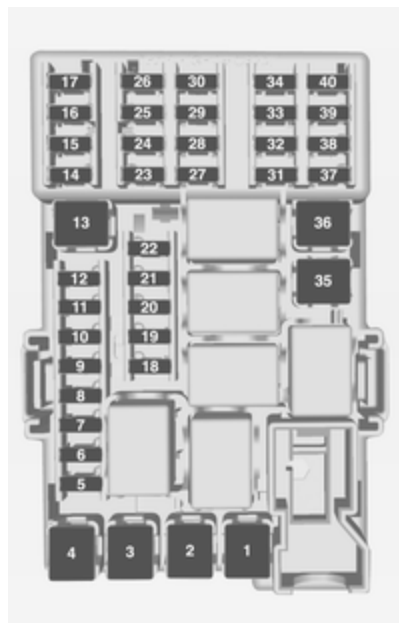

No. Circuit

- | | |
|----|-----------------------|
| 1 | – |
| 2 | – |
| 3 | Power windows |
| 4 | Voltage transformer |
| 5 | Body control module 1 |
| 6 | Body control module 2 |
| 7 | Body control module 3 |
| 8 | Body control module 4 |
| 9 | Body control module 5 |
| 10 | Body control module 6 |
| 11 | Body control module 7 |
| 12 | Body control module 8 |
| 13 | – |
| 14 | Tailgate |
| 15 | Diagnostic connector |
| 16 | Data link connection |
| 17 | Ignition |

No. Circuit

- | | |
|----|-------------------------|
| 18 | Air conditioning system |
| 19 | Audio amplifier |
| 20 | Parking assist |
| 21 | Brake switch |
| 22 | Audio system |
| 23 | Display |
| 24 | – |
| 25 | Onstar |
| 26 | Instrument panel |
| 27 | Seat heating, driver |
| 28 | – |
| 29 | – |
| 30 | Instrument panel |
| 31 | Horn |
| 32 | Seat heating, passenger |
| 33 | Heated steering wheel |
| 34 | – |

No. Circuit

35	–
36	–
37	Rear wiper
38	Cigarette lighter
39	–
40	–

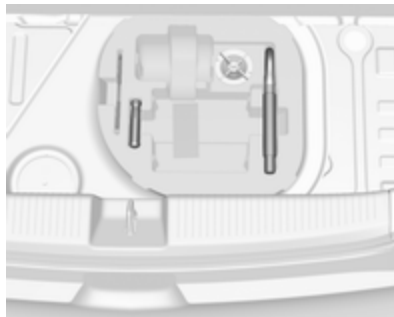
Vehicle tools**Tools****Vehicles without spare wheel**

Some tools and the towing eye are located in a tool box in the load compartment below the floor cover. On version with storage box, remove box first ⇨ 65.

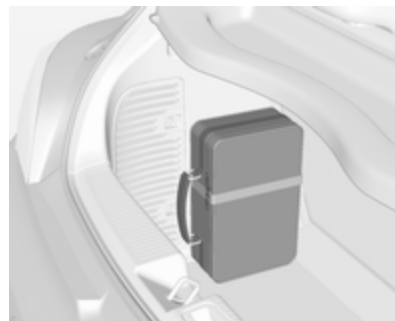

On versions with rear carrier system or liquid gas engine, the tools are located together with the towing eye, fixed with a strap at the left sidewall in the load compartment.

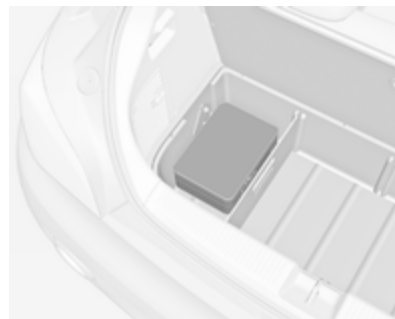

On version with storage box, the suitcase with the tools, the towing eye is located in a chamber of the box in the load compartment ⇨ 65.

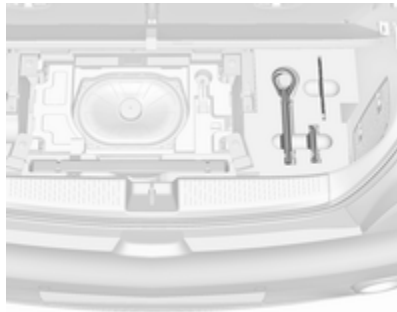

On version with subwoofer box, the tools and the towing eye are located together with the warning triangle in the box below the floor cover. To gain access, remove floor cover: fold rear part to the front and pull out the cover to the rear ⇨ 67.

Vehicles with spare wheel



The jack, the wheel bolt wrench, the tools and two straps for securing a damaged wheel are in the tool box below the load compartment floor cover ⇨ 67.

Wheels and tyres

Tyre condition, wheel condition

Drive over edges slowly and at right angles if possible. Driving over sharp edges can cause tyre and wheel damage. Do not trap tyres on the kerb when parking.

Regularly check the wheels for damage. Seek the assistance of a workshop in the event of damage or unusual wear.

We recommend not swapping the front wheels with the rear wheels and vice versa, as this can affect vehicle stability. Always use less worn tyres on the rear axle.

Winter tyres

Winter tyres improve driving safety at temperatures below 7 °C and should therefore be fitted on all wheels.

All tyre sizes are permitted as winter tyres ⇨ 228.

Tyre size 185/60 R 15 is only permitted as winter tyre.

In accordance with country-specific regulations, affix the speed sticker in the driver's field of view.

Tyre designations

E.g. **195/55 R 16 95 H**

195 : tyre width, mm

55 : cross-section ratio (tyre height to tyre width), %

R : belt type: Radial

RF : type: RunFlat

16 : wheel diameter, inches

95 : load index e.g. 95 is equivalent to 690 kg

H : speed code letter

Speed code letter:

Q : up to 160 km/h

S : up to 180 km/h

T : up to 190 km/h

H : up to 210 km/h

V : up to 240 km/h

W : up to 270 km/h

Choose a tyre appropriate for the maximum speed of your vehicle.

The maximum speed is achievable at kerb weight with driver (75 kg) plus 125 kg payload. Optional equipment could reduce the maximum speed of the vehicle.

Performance ⇨ 224.

Directional tyres

Directional tyres must be mounted so that they rotate in the correct direction. The proper rotation direction is indicated by a symbol (e.g. an arrow) on the sidewall.

Tyre pressure

Check the pressure of cold tyres at least every 14 days and before any long journey. Do not forget the spare wheel.

This also applies to vehicles with tyre pressure monitoring system.



Tyre pressure ⇨ 228.

The tyre pressure information label on the right door frame indicates the original equipment tyres and the correspondent tyre pressures.

The tyre pressure data refers to cold tyres. It applies to summer and winter tyres.

The ECO tyre pressure serves to achieve the smallest amount of fuel consumption possible.

Incorrect tyre pressures will impair safety, vehicle handling, comfort and fuel economy and will increase tyre wear.

The tyre pressure tables show all possible tyre combinations ⇨ 228.

Identify the respective tyre.

For the tyres approved for your vehicle, refer to the EEC Certificate of Conformity provided with your vehicle or other national registration documents.

The driver is responsible for correct adjustment of tyre pressure.

Warning

If the pressure is too low, this can result in considerable tyre warm-up and internal damage, leading to tread separation and even to tyre blow-out at high speeds.

Warning

For specific tyres the recommended tyre pressure as shown in the tyre pressure table may exceed the maximum tyre pressure as indicated on the tyre. Never exceed the maximum tyre pressure as indicated on the tyre.

If the tyre pressure must be reduced or increased, switch off ignition. After adjusting tyre pressure switch on ignition and select the relevant setting on the page **Tyre load** in the Driver Information Centre ⇨ 92.

Temperature dependency

The tyre pressure depends on the temperature of the tyre. During driving, tyre temperature and pressure increase. Tyre pressure values provided on the tyre information label and tyre pressure chart are valid for cold tyres, which means at 20 °C.

The pressure increases by nearly 10 kPa for a 10 °C temperature increase. This must be considered when warm tyres are checked.

The tyre pressure value displayed in the Driver Information Centre shows the real tyre pressure. A cooled down tyre will show a decreased value, which does not indicate an air leak.

Tyre pressure monitoring system

The tyre pressure monitoring system checks the pressure of all four tyres once a minute when vehicle speed exceeds a certain limit.

Caution

Tyre pressure monitoring system warns only about low tyre pressure condition and does not replace regular tyre maintenance by the driver.

All wheels must be equipped with pressure sensors and the tyres must have the prescribed pressure.

Note

In countries where the tyre pressure monitoring system is legally required, the use of wheels without pressure sensors will invalidate the vehicle operating permit.

The current tyre pressures can be shown in the **Vehicle Information Menu** in the Driver Information Centre.

The menu can be selected by pressing the buttons on the turn signal lever.

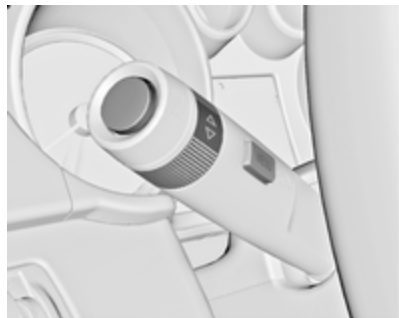

Press **MENU** to select the **Vehicle Information Menu** .

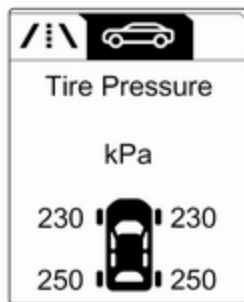



Turn the adjuster wheel to select the tyre pressure monitoring system.

System status and pressure warnings are displayed by a message with the corresponding tyre flashing in the Driver Information Centre.

The system considers the tyre temperature for the warnings.
Temperature dependency ⇨ 188.



A detected low tyre pressure condition is indicated by the control indicator  ⇨ 91.

If  illuminates, stop as soon as possible and inflate the tyres as recommended ⇨ 228.

If  flashes for 60-90 seconds then illuminates continuously, there is a fault in the system. Consult a workshop.

After inflating, some driving may be required to update the tyre pressure values in the Driver Information Centre. During this time  may illuminate.

If  illuminates at lower temperatures and extinguishes after some driving, this could be an indicator for approaching a low tyre pressure condition. Check tyre pressure.

Vehicle messages ⇨ 99.

If the tyre pressure must be reduced or increased, switch off ignition.

Only mount wheels with pressure sensors, otherwise the tyre pressure will not be displayed and  illuminates continuously.

A spare wheel or temporary spare wheel is not equipped with pressure sensors. The tyre pressure monitoring system is not operational for these tyres. Control indicator  illuminates. For the further three tyres, the system remains operational.

The use of commercially-available liquid tyre repair kits can impair the function of the system. Factory-approved repair kits can be used.

Operating electronic devices or being close to facilities using similar wave frequencies could disrupt the tyre pressure monitoring system.

Each time the tyres are replaced, tyre pressure monitoring system sensors must be dismantled and serviced. For the screwed sensor; replace valve core and sealing ring. For the clipped sensor; replace complete valve stem.

Vehicle loading status

Adjust tyre pressure to load condition according to the tyre information label or tyre pressure chart ⇨ 228, and select the appropriate setting in the menu **Tyre Load** in the Driver Information Centre, **Vehicle Information Menu** ⇨ 92. This setting is the reference for the tyre pressure warnings.

The **Tyre Load** menu only appears if the vehicle is at a standstill and the parking brake is applied. On vehicles with automatic transmission the selector lever has to be in **P**.

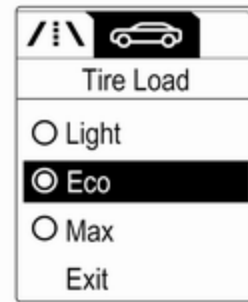

Select:

- **Light** for comfort pressure up to 3 people.
- **Eco** for Eco pressure up to 3 people.
- **Max** for full loading.

Tyre pressure sensor matching process

Each TPMS sensor has a unique identification code. The identification code must be matched to a new tyre/wheel position after rotating the tyres or exchanging the complete wheel set and if one or more TPMS sensors were replaced. The TPMS sensor

matching process should also be performed after replacing a spare tyre with a road tyre containing the TPMS sensor.

The malfunction light (⚠) and the warning message or code should go off at the next ignition cycle. The sensors are matched to the wheel positions, using a relearn tool, in the following order: left side front wheel, right side front wheel, right side rear wheel and left side rear wheel. The turn signal light at the current active position is illuminated until sensor is matched.

Consult a workshop for service. There are two minutes to match the first wheel position, and five minutes overall to match all four wheel positions. If it takes longer, the matching process stops and must be restarted.

The tyre pressure sensor matching process is:

1. Apply the parking brake.
2. Turn the ignition on.
3. On vehicles with manual transmission automated: Press

and hold brake pedal. Move and hold the selector lever for five seconds in position **N** until **P** is displayed in the Driver Information Centre. **P** indicates that the sensor matching process can be started.

On vehicles with manual transmission: select neutral.

4. Use **MENU** on the turn signal lever to select the **Vehicle Information Menu** in the Driver Information Centre.
5. Turn the adjuster wheel to scroll to the tyre pressure menu.
6. Press **SET/CLR** to begin the sensor matching process. A message requesting acceptance of the process should be displayed.
7. Press **SET/CLR** again to confirm the selection. The horn sounds twice to indicate that the receiver is in relearn mode.
8. Start with the left side front wheel.
9. Place the relearn tool against the tyre sidewall, near the valve stem. Then press the button to activate

the tyre pressure sensor. A horn chirp confirms that the sensor identification code has been matched to this wheel position.

10. Proceed to the right side front wheel, and repeat the procedure in Step 9.
11. Proceed to the right side rear wheel, and repeat the procedure in Step 9.
12. Proceed to the left side rear wheel, and repeat the procedure in Step 9. The horn sounds twice to indicate that the sensor identification code has been matched to the left side rear wheel, and the tyre pressure sensor matching process is no longer active.
13. Turn off the ignition.
14. Set all four tyres to the recommended air pressure level as indicated on the tyre information label.
15. Ensure the tyre loading status is set according to the selected pressure ⇨ 92.

Tread depth

Check tread depth at regular intervals.

Tyres should be replaced for safety reasons at a tread depth of 2-3 mm (4 mm for winter tyres).

For safety reasons it is recommended that the tread depth of the tyres on one axle should not vary by more than 2 mm.



The legally permissible minimum tread depth (1.6 mm) has been reached when the tread has worn down as far as one of the tread wear

indicators (TWI). Their position is indicated by markings on the sidewall.

Tyres age, even if they are not used. We recommend tyre replacement every 6 years.

Changing tyre and wheel size

If tyres of a different size than those fitted at the factory are used, it may be necessary to reprogramme the speedometer as well as the nominal tyre pressure and to make other vehicle modifications.

After converting to a different tyre size, have the label with tyre pressures replaced.

Tyre pressure monitoring system
↪ 189.

Caution

When converting to wheels with 14", the ground clearance will be reduced. This must be considered when passing over obstacles.

⚠ Warning

The use of unsuitable tyres or wheels may lead to accidents and will invalidate the vehicle operating permit.

Wheel covers

Wheel covers and tyres that are factory approved for the respective vehicle and comply with all of the relevant wheel and tyre combination requirements must be used.

If the wheel covers and tyres used are not factory approved, the tyres must not have a rim protection ridge.

Wheel covers must not impair brake cooling.

⚠ Warning

Use of unsuitable tyres or wheel covers could lead to sudden pressure loss and thereby accidents.

Steel wheels: When using locking wheel bolts, do not attach wheel covers.

Tyre chains



Tyre chains are only permitted on the front wheels.

Always use fine mesh chains that add no more than 10 mm to the tyre tread and the inboard sides (including chain lock).

⚠ Warning

Damage may lead to tyre blowout.

Tyre chains are only permitted on tyres of size 175/70 R 14, 185/70 R 14, 185/60 R 15, 185/65 R 15 and 195/55 R 16.

Tyre chains are not permitted on tyres of size 215/45 R 17 and 225/35 R 18.

The use of tyre chains is not permitted on the temporary spare wheel.

Tyre repair kit

Minor damage to the tyre tread can be repaired with the tyre repair kit.

Do not remove foreign bodies from the tyres.

Tyre damage exceeding 4 mm or that is at the tyre's sidewall cannot be repaired with the tyre repair kit.

⚠ Warning

Do not drive faster than 80 km/h. Do not use for a lengthy period. Steering and handling may be affected.

If you have a flat tyre:

Apply the parking brake and engage first gear.

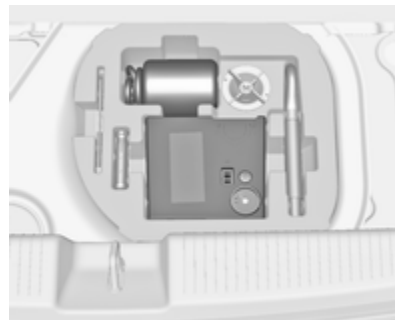

The tyre repair kit is in the tool box under the floor cover in the load compartment.

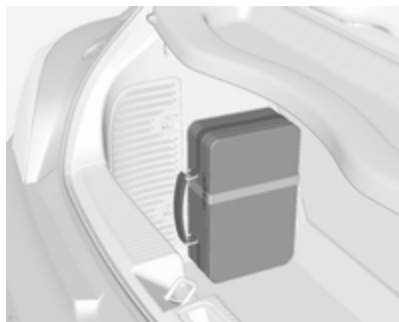

On versions with rear carrier system or liquid gas engine, the tyre repair kit is located in a suitcase and fixed with a strap at the left sidewall in the load compartment.

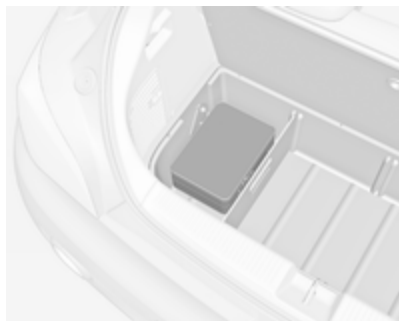

On versions with storage box in the load compartment the suitcase with the tyre repair kit is located in a chamber of the box ⇨ 65.

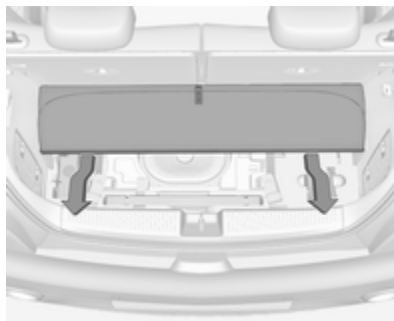

On versions with subwoofer box the tyre repair kit is located in the box under the floor cover in the load compartment. To use tyre repair kit, firstly remove floor cover: fold rear part to the front and pull out the cover to the rear ⇨ 67.

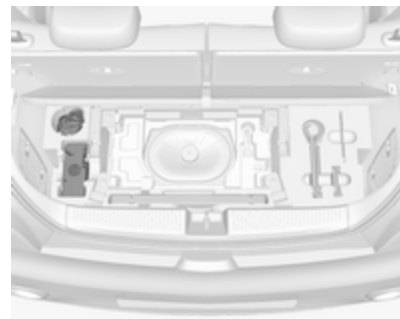

1. Take the tyre repair kit from the compartment.
2. Remove the compressor.



3. Remove the electrical connection cable and air hose from the stowage compartments on the underside of the compressor.



4. Screw the compressor air hose to the connection on the sealant bottle.
5. Fit the sealant bottle into the retainer on the compressor.
- Set the compressor near the tyre in such a way that the sealant bottle is upright.

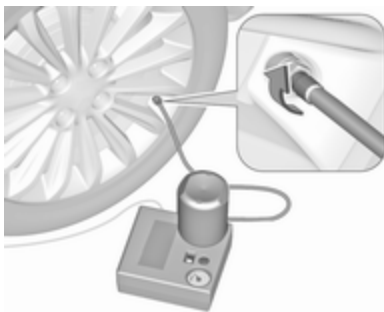

6. Unscrew valve cap from defective tyre.
7. Screw the filler hose to the tyre valve.
8. The switch on the compressor must be set to O.
9. Connect the compressor plug to the power outlet or cigarette lighter socket.
- To avoid discharging the battery, we recommend running the engine.

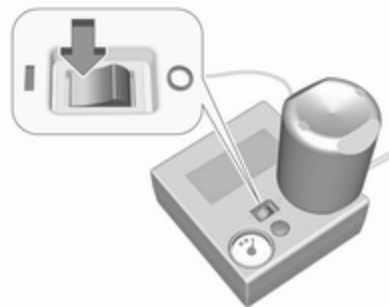

10. Set the rocker switch on the compressor to I. The tyre is filled with sealant.
11. The compressor pressure gauge briefly indicates up to six bar whilst the sealant bottle is emptying (approx. 30 seconds). Then the pressure starts to drop.
12. All of the sealant is pumped into the tyre. Then the tyre is inflated.
13. The prescribed tyre pressure should be obtained within ten minutes. Tyre pressure ⇄ 228. When the correct pressure is obtained, switch off the compressor.



If the prescribed tyre pressure is not obtained within ten minutes, remove the tyre repair kit. Move the vehicle one tyre rotation. Reattach the tyre repair kit and continue the filling procedure for ten minutes. If the prescribed tyre pressure is still not obtained, the tyre is too badly damaged. Seek the assistance of a workshop.

Drain excess tyre pressure with the button over the pressure indicator.

Do not run the compressor for longer than ten minutes.

14. Detach the tyre repair kit. Push catch on bracket to remove sealant bottle from bracket. Screw the tyre inflation hose to the free connection of the sealant bottle. This prevents sealant from escaping. Stow tyre repair kit in load compartment.
15. Remove any excess sealant using a cloth.
16. Take the label indicating maximum permitted speed from the sealant bottle and affix in the driver's field of view.
17. Continue driving immediately so that sealant is evenly distributed in the tyre. After driving approx. 10 km (but no more than ten minutes), stop and check tyre pressure. Screw compressor air hose directly onto tyre valve and compressor when doing this.

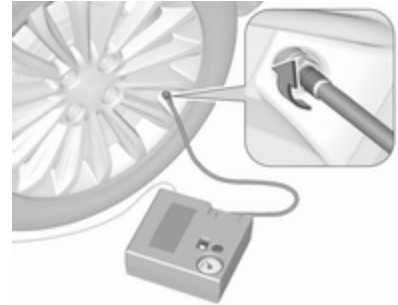

If tyre pressure is more than 1.3 bar, set it to the correct value. Repeat the procedure until there is no more loss of pressure.

If the tyre pressure has fallen below 1.3 bar, the vehicle must not be used. Seek the assistance of a workshop.

18. Stow away tyre repair kit in load compartment.
- Reinstall floor cover. Rear floor storage cover ↻ 67.

Note

The driving characteristics of the repaired tyre are severely affected, therefore have this tyre replaced.

If unusual noise is heard or the compressor becomes hot, turn compressor off for at least 30 minutes.

The built-in safety valve opens at a pressure of seven bar.

Note the expiry date of the kit. After this date its sealing capability is no longer guaranteed. Pay attention to storage information on sealant bottle.

Replace the used sealant bottle. Dispose of the bottle as prescribed by applicable laws.

The compressor and sealant can be used from approx. -30 °C.

The adapters supplied can be used to pump up other items e.g. footballs, air mattresses, inflatable dinghies etc. They are located on the underside of the compressor. To remove, screw on compressor air hose and withdraw adapter.

Wheel changing

Make the following preparations and observe the following information:

- Park the vehicle on a level, firm and non-skid surface. The front wheels must be in the straight-ahead position.
- Apply the parking brake and engage first gear or reverse gear.
- Never change more than one wheel at once.
- Use the jack only to change wheels in case of puncture, not for seasonal winter or summer tyre change.
- The jack is maintenance-free.
- If the ground on which the vehicle is standing is soft, a solid board (max. 1 cm thick) should be placed under the jack.
- Take heavy objects out of the vehicle before jacking up.
- No people or animals may be in the vehicle when it is jacked-up.
- Never crawl under a jacked-up vehicle.

- Do not start the vehicle when it is raised on the jack.
- Before screwing in the wheel bolts, clean them and lightly coat the taper of each wheel bolt with commercially available grease.

⚠ Warning
Do not grease the thread of the wheel bolt.

1. Steel wheels:

Pull off the wheel cover.

Alloy wheels with bolt caps

Disengage wheel bolt caps with a screwdriver and remove. To protect the wheel, place a soft cloth between the screwdriver and the alloy wheel.

Alloy wheels with centre cap

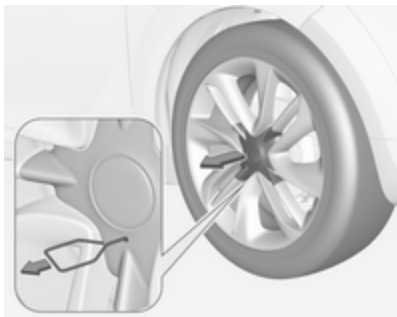

Insert extractor in the hole of the centre cap and withdraw the cap from the wheel. Vehicle tools ↪ 186.



2. Install the wheel wrench ensuring that it locates securely and loosen each wheel bolt by half a turn.

The wheels might be protected by locking wheel bolts. To loosen these specific bolts, first attach the adapter for the locking wheel bolts onto the head of the bolt wrench. The adapter is located in the glovebox.

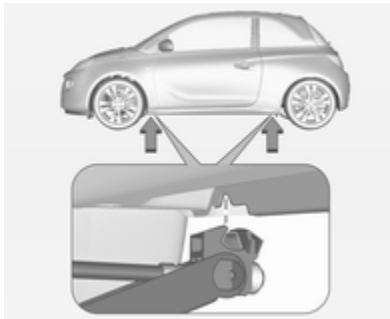

3. Ensure the jack is correctly positioned under the relevant vehicle jacking point.

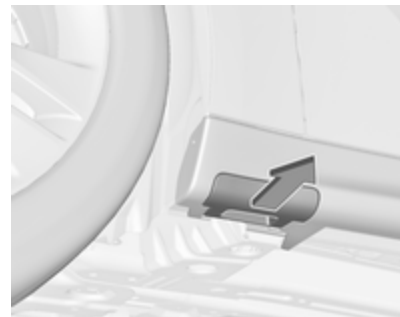

Some versions have sill panellings with covered vehicle jacking points: first pull out the cover at the respective jacking point before positioning the jack.



4. Set the jack to the necessary height. Position it directly below the jacking point in a manner that prevents it from slipping.



Attach jack handle and with the jack correctly aligned rotate handle until wheel is clear of the ground.

5. Unscrew the wheel bolts.
6. Change the wheel.
7. Screw on the wheel bolts.
8. Lower vehicle.

9. Install the wheel wrench ensuring that it is securely located and tighten each bolt in a crosswise sequence. Tightening torque is 110 Nm.
 10. Align the valve hole in the wheel cover of the steel wheel with the tyre valve before installing. Install wheel bolt caps or centre cap on alloy wheel.
 11. Stow and secure the replaced wheel, the vehicle tools ↻ 186 and the adapter for the locking wheel bolts ↻ 53.
 12. Check the tyre pressure of the installed tyre and the wheel bolt torque as soon as possible.
- Have the defective tyre renewed or repaired as soon as possible.

Jacking position for lifting platform



Rear arm position of the lifting platform, located centrally under the recess of the sill.

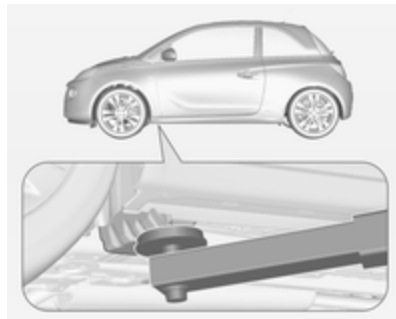

Front arm position of the lifting platform at the underbody.

Spare wheel

If mounting a spare wheel, which is different from the other wheels, this wheel might be classified as a temporary spare wheel and the corresponding speed limits apply, even though no label indicates this. Seek the assistance of a workshop to check the applicable speed limit.

The spare wheel has a steel rim.

Caution

The use of a spare wheel that is smaller than the other wheels or in combination with winter tyres could affect driveability. Have the defective tyre replaced as soon as possible.

The spare wheel is located in a holder beneath the vehicle floor.

1. Open the load compartment floor
 ⇨ 67.

Remove storage box if equipped
 ⇨ 65.

2. Remove the wheel wrench from the tool box.



3. Fit the wheel wrench on the hexagon bolt near the tool box and turn it anticlockwise until a resistance is noticeable.

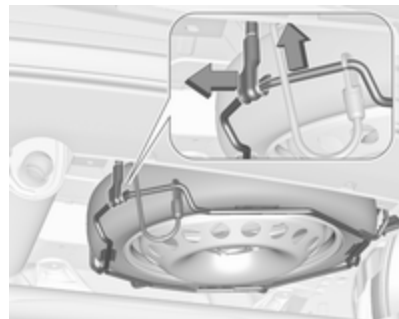

4. Lift the spare wheel holder slightly by hand and unhook the catch.
5. Lower the spare wheel holder.



- Lift the spare wheel holder slightly by hand and detach the safety cable.



- Lower holder all the way and remove spare wheel.
- Change the wheel ↪ 198.
The damaged wheel must be secured in the load compartment, see below.
- Lift the empty spare wheel holder and insert the safety cable.
- Lift the spare wheel holder farther and engage in catch. The open side of the catch must point in the direction of travel.

- Close the empty spare wheel holder by turning the hexagon bolt clockwise successively using the wheel wrench.
- Stow wheel wrench and the jack in the tool box in vehicle floor.
- Close the load compartment floor.

Stowing a damaged wheel in the load compartment

The spare wheel holder is not designed for other tyre sizes than the spare wheel.

A damaged wheel wider than the spare wheel must be stowed in the load compartment and secured with a strap. Vehicle tools ↪ 186.

Wheels with tyre size up to 195/55 R 16

- Remove load compartment cover and lift up load compartment floor. Stow both behind the raised up backrests of the rear seats.

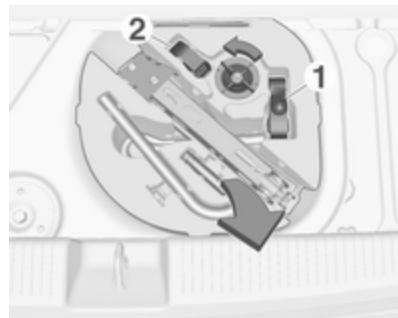

- Untwist wing nut and remove tool box.
- Position the damaged wheel to stand upright into the tool box spare, facing to the front.

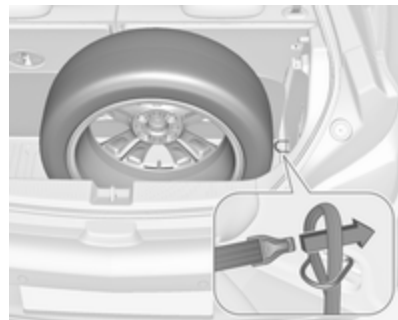

4. Remove strap 1 from the tool box and place the loop end of the strap through the right side lashing eye.
5. Place the hook end of the strap through the loop and pull it until the strap is fastened securely to the lashing eye.

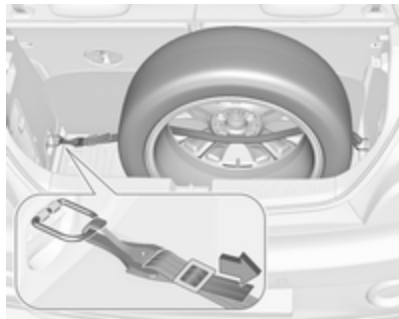

6. Insert the strap through the spokes of the wheel as shown in the illustration.
7. Mount the hook to the left side lashing eye.
8. Tighten the strap and secure it using the buckle.

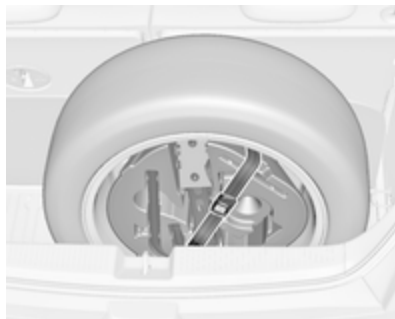

9. Position the tool box in the inside of the wheel and secure it with strap 2 inserted through two spokes of the wheel.

Wheels with tyre size bigger than 195/55 R 16

1. Fold down backrests of the rear seats ⇨ 64.

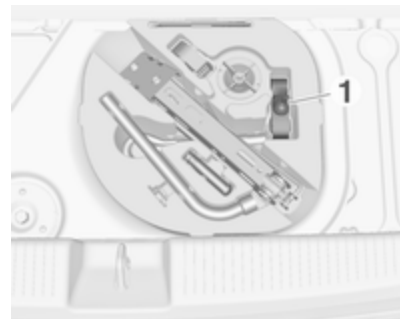

2. Remove strap 1 from the tool box.
3. Position the damaged wheel with outer side facing downwards in the load compartment.

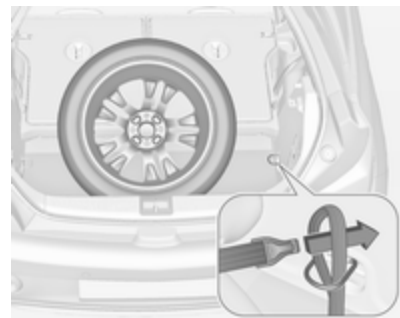

4. Take strap 1 and place the loop end of the strap through the right side lashing eye.
5. Place the hook end of the strap through the loop and pull it until the strap is fastened securely to the lashing eye.

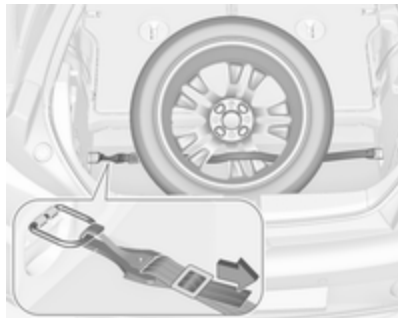

6. Insert the strap through the spokes of the wheel as shown in the illustration.
7. Mount the hook to the left side lashing eye.
8. Tighten the strap and secure it using the buckle.

⚠ Warning

Storing a jack, a wheel or other equipment in the load compartment could cause injury if they are not fixed properly. During a sudden stop or a collision, loose equipment could strike someone.

Store jack and tools always in the respective storage compartments and secure them by fixing.

Damaged wheel placed in the load compartment must always be secured by the strap.

Temporary spare wheel

Caution

The use of the temporary spare wheel could affect driveability. Have the defective tyre renewed or repaired as soon as possible.

Only mount one temporary spare wheel. Do not drive faster than 80 km/h. Take curves slowly. Do not use for a long period of time.

If your vehicle gets a flat tyre on the rear while towing another vehicle, mount the temporary spare wheel in the front and the full size tyre in the rear.

Tyre chains ⇨ 194.

Spare wheel with directional tyre

If possible, fit directional tyres such that they roll in the direction of travel. The rolling direction is indicated by a symbol (e.g. an arrow) on the sidewall.

The following applies to tyres fitted opposing the rolling direction:

- Driveability may be affected. Have the defective tyre renewed or repaired as soon as possible and fit it instead of the spare wheel.
- Drive particularly carefully on wet and snow-covered road surfaces.

Jump starting

Do not start with a quick charger.

A vehicle with a discharged vehicle battery can be started using jump leads and the vehicle battery of another vehicle.

⚠ Warning

Be extremely careful when starting with jump leads. Any deviation from the following instructions can lead to injuries or damage caused by battery explosion or damage to the electrical systems of both vehicles.

⚠ Warning

Avoid contact of the battery with eyes, skin, fabrics and painted surfaces. The fluid contains sulphuric acid which can cause injuries and damage in the event of direct contact.

- Never expose the battery to naked flames or sparks.

- A discharged vehicle battery can already freeze at a temperature of 0 °C. Defrost the frozen battery before connecting jump leads.
- Wear eye protection and protective clothing when handling a battery.
- Use a booster battery with the same voltage (12 Volts). Its capacity (Ah) must not be much less than that of the discharged battery.
- Use jump leads with insulated terminals and a cross section of at least 16 mm² (25 mm² for diesel engines).
- Do not disconnect the discharged vehicle battery from the vehicle.
- Switch off all unnecessary electrical consumers.
- Do not lean over the battery during jump starting.
- Do not allow the terminals of one lead to touch those of the other lead.
- The vehicles must not come into contact with each other during the jump starting process.

- Apply the parking brake, transmission in neutral.
- Open the positive terminal protection caps of both vehicle batteries.

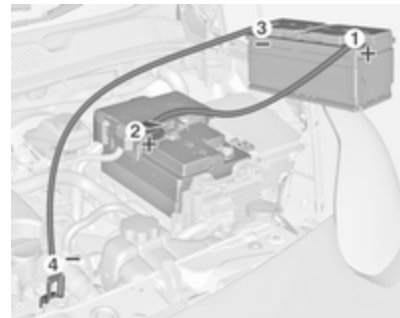

Lead connection order:

1. Connect the red lead to the positive terminal of the booster battery.
2. Connect the other end of the red lead to the positive terminal of the discharged battery.

3. Connect the black lead to the negative terminal of the booster battery.
4. Connect the other end of the black lead to a vehicle grounding point, such as the engine block or an engine mounting bolt. Connect as far away from the discharged vehicle battery as possible, however at least 60 cm.

Route the leads so that they cannot catch on rotating parts in the engine compartment.

To start the engine:

1. Start the engine of the vehicle providing the jump.
2. After five minutes, start the other engine. Start attempts should be made for no longer than 15 seconds at an interval of one minute.
3. Allow both engines to idle for approx. three minutes with the leads connected.

4. Switch on electrical consumers (e.g. headlights, heated rear window) of the vehicle receiving the jump start.
5. Reverse above sequence exactly when removing leads.

Towing

Towing the vehicle

The towing eye is stowed with the vehicle tools ↗ 186.

Adam



1. Disengage the cap by pushing at the marked position.

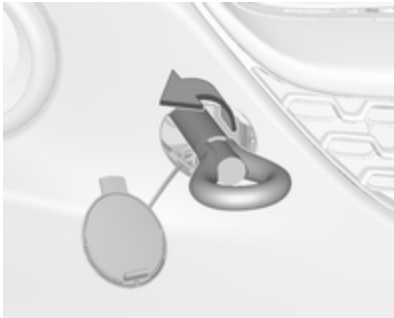

2. Screw in the towing eye as far as it will go until it stops in a horizontal position.
3. Attach a tow rope – or better still a tow rod – to the towing eye.

Adam Rocks



1. Disengage the small cap with a screwdriver at the marked position.

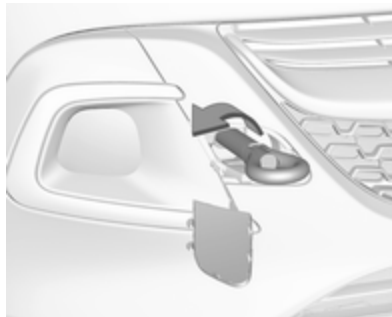

2. Screw in the towing eye as far as it will go until it stops in a horizontal position.
3. Attach a tow rope – or better still a tow rod – to the towing eye.

General

The towing eye must only be used for towing and not for recovering the vehicle.

Switch on ignition to release steering wheel lock and to permit operation of brake lights, horn and windscreen wiper.

Switch the selector lever to neutral.

Release the parking brake.

Caution

Drive slowly. Do not drive jerkily. Excessive tractive force can damage the vehicle.

When the engine is not running, considerably more force is needed to brake and steer.

To prevent the entry of exhaust gases from the towing vehicle, switch on the air recirculation and close the windows.

Vehicles with manual transmission automated: the vehicle must only be towed facing forwards with the front axle raised off the ground.

Seek the assistance of a workshop. After towing, unscrew the towing eye. Insert cap and engage in the front bumper.

Towing another vehicle

Adam

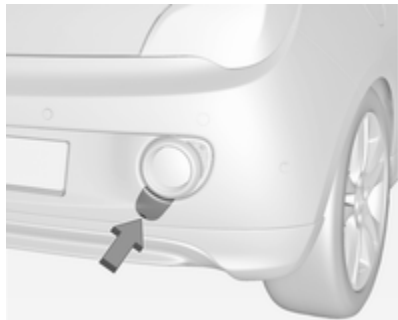

Insert a screwdriver in the slot at the lower bend of the cap. Disengage the cap by carefully moving the screwdriver downwards.

The towing eye is stowed with the vehicle tools ⇨ 186.



Screw in the towing eye as far as it will go until it stops in a horizontal position.

The lashing eye at the rear underneath the vehicle must never be used as a towing eye.

Attach a tow rope – or even better a tow bar – to the towing eye.

The towing eye must only be used for towing and not for recovering a vehicle.

Caution

Drive slowly. Do not drive jerkily. Excessive tractive force can damage the vehicle.

After towing, unscrew the towing eye. Insert cap and engage in the bumper.

Adam Rocks

Towing another vehicle is not possible.

Appearance care

Exterior care

Locks

The locks are lubricated at the factory using a high quality lock cylinder grease. Use a de-icing agent only when absolutely necessary, as this has a degreasing effect and impairs lock function. After using a de-icing agent, have the locks regreased by a workshop.

Washing

Adam without foldable sunroof:

The paintwork of your vehicle is exposed to environmental influences. Wash and wax your vehicle regularly. When using automatic vehicle washes, select a programme that includes waxing. Restrictions for filmed or matt painted body parts or decor tapes, see "Polishing and waxing".

Adam with foldable sunroof:

The paintwork of your vehicle is exposed to environmental influences, therefore wash your vehicle regularly.

When using automatic vehicle washes, select one with textile brushes and select a programme without wax additives.

Restrictions for filmed or matt painted body parts or decor tapes, see "Polishing and waxing".

When hand washing the vehicle, use clear water and a soft brush, cleaning in grain direction of the textile sun roof.

Never use a steam-jet or high-pressure jet cleaner for the sunroof.

Wax painted parts of the vehicle regularly, but not the textile of the sunroof.

Caution

After washing or cleaning, the foldable sunroof must be completely dried before opening. If a wet sunroof remains opened for

a longer time, it would be damaged by water spotting and mould growth.

All variants:

Bird droppings, dead insects, resin, pollen and the like should be cleaned off immediately, as they contain aggressive constituents which can cause paint damage.

If using a car wash, comply with the car wash manufacturer's instructions. The windscreen wiper and rear window wiper must be switched off. Remove antenna and external accessories such as roof racks etc.

If you wash your vehicle by hand, make sure that the insides of the wheel housings are also thoroughly rinsed out.

Clean edges and folds on opened doors and the bonnet as well as the areas they cover.

Clean bright metal mouldings with a cleaning solution approved for aluminium to avoid damages.

Caution
<p>Always use a cleaning agent with a pH value of four to nine.</p> <p>Do not use cleaning agents on hot surfaces.</p>

Have the door hinges of all doors greased by a workshop.

Do not clean the engine compartment with a steam-jet or high-pressure jet cleaner.

On vehicles with emblem touchpad: when cleaning with a high-pressure jet cleaner ensure a minimum distance of 30 cm when working around the tailgate to prevent unintended unlocking.

Thoroughly rinse and leather-off the vehicle. Rinse leather frequently. Use separate leathers for painted and glass surfaces: remnants of wax on the windows will impair vision.

Do not use hard objects to remove spots of tar. Use tar removal spray on painted surfaces.

Exterior lights

Headlight and other light covers are made of plastic. Do not use any abrasive or caustic agents, do not use an ice scraper, and do not clean them dry.

Polishing and waxing

Wax painted parts of the vehicle regularly (at the latest when water no longer beads). Otherwise, the paintwork will dry out.

The foldable sunroof must not be polished or waxed. When using automatic car washes, select a programme without wax additives.

Polishing is necessary only if the paint has become dull or if solid deposits have become attached to it.

Paintwork polish with silicone forms a protective film, making waxing unnecessary.

Unpainted plastic body parts must not be treated with wax or polishing agents.

Matt filmed body parts or decor tapes must not be polished, to avoid gleaming. Do not use hot wax

programmes in automatic car washes if the vehicle is equipped with these parts.

Matt painted decor parts, e.g. mirror housing cover, must not be polished. Otherwise these parts would become agleam or the colour would be dissolved.

Windows and windscreen wiper blades

Use a soft lint-free cloth or chamois leather together with window cleaner and insect remover.

When cleaning the rear window from inside, always wipe in parallel to the heating element to prevent damage.

For mechanical removal of ice, use a sharp-edged ice scraper. Press the scraper firmly against the glass so that no dirt can get under it and scratch the glass.

Clean smearing wiper blades with a soft cloth and window cleaner.

Glass panel

Never clean with solvents or abrasive agents, fuels, aggressive media (e.g. paint cleaner, acetone-containing solutions etc.), acidic or highly alkaline media or abrasive pads. Do not apply wax or polishing agents to the glass panel.

Wheels and tyres

Do not use high-pressure jet cleaners.

Clean rims with a pH-neutral wheel cleaner.

Rims are painted and can be treated with the same agents as the body.

Paintwork damage

Rectify minor paintwork damage with a touch-up pen before rust forms. Have more extensive damage or rust areas repaired by a workshop.

Underbody

Some areas of the vehicle underbody have a PVC undercoating while other critical areas have a durable protective wax coating.

After the underbody is washed, check the underbody and have it waxed if necessary.

Bitumen/rubber materials could damage the PVC coating. Have underbody work carried out by a workshop.

Before and after winter, wash the underbody and have the protective wax coating checked.

Liquid gas system

Danger

Liquid gas is heavier than air and can collect in sink points.

Take care when performing work at the underbody in a pit.

For painting work and when using a drying booth at a temperature above 60 °C, the liquid gas tank must be removed.

Do not make any modifications to the liquid gas system.

Rear carrier system

Clean the rear carrier system with a steam-jet or high-pressure jet cleaner at least once a year.

Operate the rear carrier system periodically if not in regular use, in particular during winter.

Interior care

Interior and upholstery

Only clean the vehicle interior, including the instrument panel fascia and panelling, with a dry cloth or interior cleaner.

Clean the leather upholstery with clear water and a soft cloth. In case of heavy soiling, use leather care.

The instrument cluster and the displays should only be cleaned using a soft damp cloth. If necessary use a weak soap solution.

Clean fabric upholstery with a vacuum cleaner and brush. Remove stains with an upholstery cleaner.

Clothing fabrics may not be colourfast. This could cause visible discolourations, especially on light-coloured upholstery. Removable stains and discolourations should be cleaned as soon as possible.

Clean seat belts with lukewarm water or interior cleaner.

Caution
<p>Close Velcro fasteners as open Velcro fasteners on clothing could damage seat upholstery.</p> <p>The same applies to clothing with sharp-edged objects, like zips or belts or studded jeans.</p>

Plastic and rubber parts

Plastic and rubber parts can be cleaned with the same cleaner as used to clean the body. Use interior cleaner if necessary. Do not use any other agent. Avoid solvents and petrol in particular. Do not use high-pressure jet cleaners.

Service and maintenance

General information	213
Service information	213
Recommended fluids, lubricants and parts	214
Recommended fluids and lubricants	214

General information

Service information

In order to ensure economical and safe vehicle operation and to maintain the value of your vehicle, it is of vital importance that all maintenance work is carried out at the proper intervals as specified.

The detailed, up-to-date service schedule for your vehicle is available at the workshop.

Service display ⇨ 84.

European service intervals

Maintenance of your vehicle is required every 30,000 km or after 1 year, whichever occurs first, unless otherwise indicated in the service display.

A shorter service interval can be valid for severe driving behaviour, e.g. for taxis and police vehicles.

The European service intervals are valid for the following countries:

Andorra, Austria, Belgium, Bosnia-Herzegovina, Bulgaria, Croatia, Cyprus, Czech Republic, Denmark, Estonia, Finland, France, Germany, Greece, Greenland, Hungary, Iceland, Ireland, Italy, Latvia, Liechtenstein, Lithuania, Luxembourg, Macedonia, Malta, Monaco, Montenegro, Netherlands, Norway, Poland, Portugal, Romania, San Marino, Serbia, Slovakia, Slovenia, Spain, Sweden, Switzerland, United Kingdom.

Service display ⇨ 84.

International service intervals

Maintenance of your vehicle is required every 15,000 km or after 1 year, whichever occurs first, unless otherwise indicated in the service display.

Severe operating conditions exist if one or more of the following circumstances occur frequently: Cold starting, stop and go operation, trailer operation, mountain driving, driving on poor and sandy road surfaces, increased air pollution, presence of airborne sand and high dust content,

driving at high altitude and large variations of temperature. Under these severe operating conditions, certain service work may be required more frequently than the regular service interval.

The international service intervals are valid for the countries which are not listed in the European service intervals.

Service display ⇨ 84.

Confirmations

Confirmation of service is recorded in the Service and Warranty Booklet. The date and mileage is completed with the stamp and signature of the servicing workshop.

Make sure that the Service and Warranty Booklet is completed correctly as continuous proof of service is essential if any warranty or goodwill claims are to be met, and is also a benefit when selling the vehicle.

Service interval with remaining engine oil life duration

The service interval is based on several parameters depending on usage.

The service display lets you know when to change the engine oil.

Service display ⇨ 84.

Recommended fluids, lubricants and parts

Recommended fluids and lubricants

Only use products that meet the recommended specifications.

Warning

Operating materials are hazardous and could be poisonous. Handle with care. Pay attention to information given on the containers.

Engine oil

Engine oil is identified by its quality and its viscosity. Quality is more important than viscosity when selecting which engine oil to use. The oil quality ensures e.g. engine cleanliness, wear protection and oil aging control, whereas viscosity grade gives information on the oil's thickness over a temperature range.

Dexos is the newest engine oil quality that provides optimum protection for petrol and diesel engines. If it is unavailable, engine oils of other listed qualities have to be used.

Recommendations for petrol engines are also valid for Compressed Natural Gas (CNG), Liquefied Petroleum Gas (LPG) and Ethanol (E85) fuelled engines.

Select the appropriate engine oil based on its quality and on the minimum ambient temperature ↷ 219.

Topping up engine oil

Caution

In case of any spilled oil, wipe it up and dispose it properly.

Engine oils of different manufacturers and brands can be mixed as long as they comply with the required engine oil quality and viscosity.

Use of engine oils for all petrol engines with only ACEA quality is prohibited, since it can cause engine damage under certain operating conditions.

Select the appropriate engine oil based on its quality and on the minimum ambient temperature ↷ 219.

Additional engine oil additives

The use of additional engine oil additives could cause damage and invalidate the warranty.

Engine oil viscosity grades

The SAE viscosity grade gives information of the thickness of the oil.

Multigrade oil is indicated by two figures, e.g. SAE 5W-30. The first figure, followed by a W, indicates the low temperature viscosity and the second figure the high temperature viscosity.

Select the appropriate viscosity grade depending on the minimum ambient temperature ↷ 219.

All of the recommended viscosity grades are suitable for high ambient temperatures.

Coolant and antifreeze

Use only silicate-free long life coolant (LLC) antifreeze. Consult a workshop.

The system is factory filled with coolant designed for excellent corrosion protection and frost protection down to approx. -28 °C. In northern countries with very low temperatures the factory filled coolant provides frost protection down to approx. -37 °C. This concentration should be maintained all year round. The use of additional coolant additives that intend to give additional corrosion protection or seal against minor leaks can cause function problems. Liability for consequences resulting from the use of additional coolant additives will be rejected.

Washer fluid

Use only washer fluid approved for the vehicle to prevent damage of wiper blades, paintwork, plastic and rubber parts. Consult a workshop.

Brake and clutch fluid

Over time, brake fluid absorbs moisture which will reduce braking effectiveness. The brake fluid should therefore be replaced at the specified interval.

Technical data

Vehicle identification	217
Vehicle Identification Number ..	217
Identification plate	218
Engine identification	218
Vehicle data	219
Recommended fluids and lubricants	219
Engine data	222
Performance	224
Vehicle weight	225
Vehicle dimensions	226
Capacities	227
Tyre pressures	228

Vehicle identification

Vehicle Identification Number



The Vehicle Identification Number is stamped on the identification plate and on the floor pan, under the floor covering, visible under a cover.



The Vehicle Identification Number may be embossed on the instrument panel visible through the windscreen, or in the engine compartment on the right body panel.

Identification plate



The identification plate is located on the left or right front door frame.

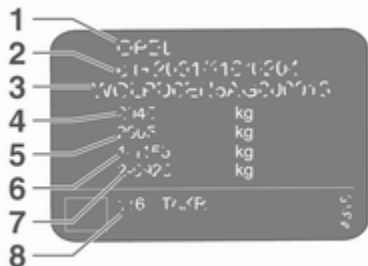

Information on identification label:

- 1 : manufacturer
- 2 : type approval number
- 3 : Vehicle Identification Number
- 4 : permissible gross vehicle weight rating in kg
- 5 : permissible gross train weight in kg
- 6 : maximum permissible front axle load in kg
- 7 : maximum permissible rear axle load in kg
- 8 : vehicle-specific or country-specific data

The combined total of front and rear axle loads must not exceed the permissible gross vehicle weight. For example, if the front axle is bearing its maximum permissible load, the rear axle can only bear a load that is equal to the gross vehicle weight minus the front axle load.

The technical data is determined in accordance with European Community standards. We reserve the right to make modifications. Specifications in the vehicle documents always have priority over those given in this manual.

Engine identification

The technical data tables use the engine identifier code. The engine data table additionally shows the engineering code. Engine data ⇨ 222.

To identify the respective engine, refer to the EEC Certificate of Conformity provided with your vehicle or other national registration documents.

The Certificate of Conformity shows the engine identifier code, other national publications may show the engineering code. Check piston displacement and engine power to identify the respective engine.

Vehicle data

Recommended fluids and lubricants

European service schedule

Required engine oil quality

All European countries with European service interval ↻ 213

Engine oil quality	Petrol engines B10XFT, B14NEH	All other petrol engines (including CNG, LPG, E85)
dexos1 Gen2	✓	–
dexos2	–	✓

All engines except B10XFT and B14NEH: In case dexos quality is unavailable, you may use max. one litre engine oil quality ACEA C3 for topping up once between each oil change.

Engine oil viscosity grades

All European countries with European service interval ↻ 213

Ambient temperature	Petrol engines
down to -25 °C	SAE 0W-30 or SAE 0W-40 SAE 5W-30 or SAE 5W-40
below -25 °C	SAE 0W-30 or SAE 0W-40

International service schedule

Required engine oil quality

All countries with international service interval ⇨ 213

Engine oil quality	Petrol engines B10XFT, B14NEH	All other petrol engines (including CNG, LPG, E85)
dexos1 Gen2	✓	–
dexos2	–	✓

In case dexos quality is unavailable, you may use the oil qualities listed below:

All countries with international service interval ⇨ 213

Engine oil quality	Petrol engines B10XFT, B14NEH	All other petrol engines (including CNG, LPG, E85)
ACEA A3/B4	–	✓
ACEA C3	–	✓

Engine oil viscosity grades

All countries with international service interval ↻ 213

Ambient temperature	Petrol engines
down to -25 °C	SAE 0W-30 or SAE 0W-40 SAE 5W-30 or SAE 5W-40
below -25 °C	SAE 0W-30 or SAE 0W-40
down to -20 °C	SAE 10W-30 ¹⁾ or SAE 10W-40 ¹⁾

1) Permitted, but usage of oils with dexos quality is recommended.

Engine data

Engine identifier code	B10XFL	B10XFT	B12XEL	B14XEL
Sales designation	1.0	1.0	1.2	1.4
Engineering code	B10XFT	B10XFT	B12XER	B14XER
Piston displacement [cm ³]	999	999	1229	1398
Engine power [kW]	66	85	51	64
at rpm	3700-6000	5000-6000	5600	6000
Torque [Nm]	170	170	115	130
at rpm	1800-3700	1800-4500	4000	4000
Fuel type	Petrol	Petrol	Petrol	Petrol
Octane rating RON ²⁾				
recommended	95	95	95	95
possible	98	98	98	98
possible	91	91	91	91
Additional fuel type	–	–	–	–

2) A country-specific label at the fuel filler flap can supersede the engine-specific requirement.

Engine identifier code	B14XEL	B14XER	B14NEH
Sales designation	1.4 LPG	1.4	Adam S
Engineering code	B14XER	B14XER	B14NET
Piston displacement [cm ³]	1398	1398	1364
Engine power [kW]	64	74	110
at rpm	6000	6000	5000
Torque [Nm]	130 ³⁾	130	220
at rpm	4000	4000	3000-4500
Fuel type	Liquid gas/Petrol	Petrol	Petrol
Octane rating RON ²⁾			
recommended	95	95	98
possible	98	98	95
possible	91	91	–
Additional fuel type	Liquid gas (LPG)	–	–

2) A country-specific label at the fuel filler flap can supersede the engine-specific requirement.

3) LPG operation: 124.

Performance

Engine	B10XFL	B10XFT	B12XEL	B14XEL	B14XEL		
					LPG	B14XER	B14NEH
Maximum speed [km/h]							
Manual transmission	180	196	165	176	176	185	210
Manual transmission automated	–	–	–	178	–	–	–

Vehicle weight

Kerb weight, basic model without any optional equipment

	Engine	Manual transmission	Manual transmission automated
without/with air conditioning [kg]	B10XFL	1141/1156	–
	B10XFT	1141/1156	–
	B12XEL	1086/1101	–
	B14XEL	1120/1135	1120/1135
	B14XEL LPG	1163/1178	–
	B14XER	1120/1135	–
	B14NEH	1163/1178	–

Optional equipment and accessories increase the kerb weight.

Loading information ⇨ 70.

Vehicle dimensions

Length [mm]	3747
Width without exterior mirrors [mm]	1720
Width with two exterior mirrors [mm]	1966
Height (without antenna) [mm]	1475-1508 ⁴⁾
Length of load compartment floor [mm]	462
Length of load compartment with folded rear seats [mm]	1041
Load compartment width [mm]	954
Load compartment height [mm]	874
Wheelbase [mm]	2311
Turning circle diameter [m]	10.17-11.06 ⁴⁾

4) Depending on equipment.

Capacities

Engine oil

Engine	B10XFL	B10XFT	B12XEL	B14XEL	B14XEL LPG	B14XER	B14NEH
including Filter [l]	4.0	4.0	4.0	4.0	4.0	4.0	4.0
between MIN and MAX [l]	1.0	1.0	1.0	1.0	1.0	1.0	1.0

Fuel tank

Engine	B10XFL	B10XFT	B12XEL	B14XEL	B14XEL LPG	B14XER	B14NEH
Petrol, refilling quantity [l]	35	35	35	35	35	35	35
LPG, refilling quantity [l]	–	–	–	–	35	–	–

Tyre pressures

Engine	Tyres	Comfort with up to 3 people		ECO with up to 3 people		With full load	
		front	rear	front	rear	front	rear
		[kPa/bar] ([psi])	[kPa/bar] ([psi])	[kPa/bar] ([psi])	[kPa/bar] ([psi])	[kPa/bar] ([psi])	[kPa/bar] ([psi])
B10XFL, B12XEL, B14XEL, B14XEL LPG, B14XER	175/70 R14, 185/70 R14, 185/60 R15, 185/65 R15, 195/55 R16, 215/45 R17, 225/35 R18	220/2.2 (32)	200/2.0 (29)	290/2.9 (42)	270/2.7 (39)	260/2.6 (38)	320/3.2 (46)
B10XFT	185/60 R15, 195/55 R16, 215/45 R17, 225/35 R18	220/2.2 (32)	200/2.0 (29)	290/2.9 (42)	270/2.7 (39)	260/2.6 (38)	320/3.2 (46)
B14NEH	195/55 R16, 215/45 R17, 225/35 R18	220/2.2 (32)	200/2.0 (29)	290/2.9 (42)	270/2.7 (39)	260/2.6 (38)	320/3.2 (46)

Engine	Tyres	Comfort with up to 3 people		ECO with up to 3 people		With full load	
		front	rear	front	rear	front	rear
		[kPa/bar] ([psi])	[kPa/bar] ([psi])	[kPa/bar] ([psi])	[kPa/bar] ([psi])	[kPa/bar] ([psi])	[kPa/bar] ([psi])
All	Temporary spare wheel 115/70 R16	420/4.2 (61)	420/4.2 (61)	–	–	420/4.2 (61)	420/4.2 (61)

Customer information

Customer information	230
Declaration of conformity	230
Collision damage repair	233
REACH	233
Collision damage repair	233
Software acknowledgement	234
Registered trademarks	235
Vehicle data recording and privacy	236
Event data recorders	236
Radio Frequency Identification (RFID)	236

Customer information

Declaration of conformity

Transmission systems

This vehicle has systems that transmit and / or receive radio waves subject to Directive 1999/5/EC or 2014/53/EU. The manufacturers of the systems listed below declare conformity with Directive 1999/5/EC or 2014/53/EU. The full text of the EU declaration of conformity for each system is available at the following internet address: www.opel.com/conformity

Importer is
Opel / Vauxhall, Bahnhofplatz,
65423 Ruesselsheim am Main,
Germany.

Antenna

Laird
8100 Industrial Park Drive, Grand
Blanc, MI, 48439 USA
Operation frequency: N/A
Maximum output: N/A
Kathrein Automotive GmbH

Roemerring 1, 31137 Hildesheim,
Germany

Operation frequency: N/A

Maximum output: N/A

Immobiliser

Continental Automotive GmbH
Siemensstrasse 12, D-93055
Regensburg, Germany

Operation frequency: 125 kHz

Maximum output:

4.9 dB μ A/m @ 10 m

Infotainment system R 4.0 / Navi 4.0

LGE

LG Electronics European Shared
Service Center B.V., Krijgsman 1,
1186 DM Amstelveen, The
Netherlands

Operation frequency (MHz)	Maximum output (dBm)
---------------------------	----------------------

2400.0 - 2483.5	4
-----------------	---

2400.0 - 2483.5	13
-----------------	----

5725.0 - 5850.0	13
-----------------	----

Infotainment system R300 BT

Humax Automotive Co. Ltd.

2, Yeongmun-ro, Cheoin-gu, Yong-in-si, Gyeonggi-do, Korea

Operation frequency:

2402 - 2480 MHz

Maximum output: 4 dBm

OnStar module

LGE

LG Electronics European Shared Service Center B.V., Krijgsman 1, 1186 DM Amstelveen, The Netherlands

Operation frequency (MHz)	Maximum output (dBm)
---------------------------	----------------------

2402 - 2480	4
-------------	---

2412 - 2462	18
-------------	----

880 - 915	33
-----------	----

1710 - 1785	24
-------------	----

1850 - 1910	24
-------------	----

1920 - 1980	24
-------------	----

2500 - 2570	23
-------------	----

Radio remote control transmitter

Continental

Continental Automotive GmbH, Siemensstraße 12, 93055 Regensburg, Germany

Operation frequency: 433.92 MHz

Maximum output: -11.2 dbm

Radio remote control receiver

Continental

Continental Automotive GmbH, Siemensstraße 12, 93055 Regensburg, Germany

Operation frequency: 433.92 MHz

Maximum output: N/A

Tyre pressure sensors

Schrader Electronics Ltd.

11 Technology Park, Belfast Road, Antrim BT41 1QS, Northern Ireland, United Kingdom

Operation frequency: 433.92 MHz

Maximum output: 10 dBm



Wir leben Autos.

Konformitätserklärung

nach EG Richtlinie 2006/42/EG

Hiermit erklären wir, dass das Produkt:

Produktbezeichnung: Wagenheber

Typ/GM-Teilenummern: 13331022

den Bestimmungen der Richtlinie 2006/42/EG entspricht.

Angewendete technische Normen:

- GM92737 Jacking
- GM 14337 Standard Equipment Jack - Hardware Tests
- GM93127 Vehicle Integrity-Hoisting and Service Station Jacking
- GMW15005 Standard Equipment Jack and Spare Tire, Vehicle Test
- ISO TS 16949 Qualitätsmanagementsystem

Der Unterzeichner ist Bevollmächtigter für die Zusammenstellung der technischen Unterlagen.

Rüsselsheim, 31. Januar 2014

Hans-Peter Metzger
Engineering Group Manager Chassis & Structure
Adium Opel AG

Adium Opel AG
R&D-Bereich
F1911 4217/30.1/3141 4217.7/30.00
www.opel.de

Vertraulich
Nur für den internen Gebrauch
Michael Lohschulte, Dr. Thomas Seifert,
Peter Thum, Susanne Weidinger, Julia Wilken

Aufsichtsrat
Ergebnis 1 (GmbH (Neueinsteiger))

Teil der Gesellschaft: OpelAutomotive
Anfangsbeitrag: 1000000,00 € (1000000,00 €)
Körpersatzung der Opel

Translation of the original declaration of conformity

Declaration of conformity according to EC Directive 2006/42/EC

We declare that the product:

Product designation: Jack

Type/GM part number: 13331922

is in compliance with the provisions of Directive 2006/42/EC.

Applied technical standards:

- GMN9737 : Jacking
- GM 14337 : Standard Equipment Jack – Hardware Tests
- GMN5127 : Vehicle Integrity – Hoisting and Service Station Jacking
- GMW15005 : Standard Equipment Jack and Spare Tyre, Vehicle Test
- ISO TS 16949 : Quality management systems

The signatory is authorised to compile the technical documentation.

Rüsselsheim, 31st January 2014

signed by

Hans-Peter Metzger

Engineering Group Manager Chassis & Structure

Adam Opel AG

D-65423 Rüsselsheim

Collision damage repair**Paint thickness**

Due to production techniques, the thickness of the paint can vary between 50 and 400 µm.

Therefore, different paint thickness is no indicator for a collision damage repair.

REACH

Registration, Evaluation, Authorisation and Restriction of Chemicals (REACH) is a European Union regulation adopted to improve the protection of human health and the environment from the risks that can be posed by chemicals. Visit www.opel.com/reach for further information and for access to the Article 33 communication.

Collision damage repair**Paint thickness**

Due to production techniques, the thickness of the paint can vary between 50 and 400 µm.

Therefore, different paint thickness is no indicator for a collision damage repair.

Software acknowledgement

Certain OnStar components include libcurl and unzip software and other third party software. Below are the notices and licenses associated with libcurl and unzip and for other third party software please see <http://www.lg.com/global/support/opensource/index>.

libcurl

Copyright and permission notice

Copyright (c) 1996 - 2010, Daniel Stenberg, <daniel@haxx.se>.

All rights reserved.

Permission to use, copy, modify, and distribute this software for any purpose with or without fee is hereby granted, provided that the above copyright notice and this permission notice appear in all copies.

The software is provided "as is", without warranty of any kind, express or implied, including but not limited to the warranties of merchantability, fitness for a particular purpose and noninfringement of third party rights. In no event shall the authors or

copyright holders be liable for any claim, damages or other liability, whether in an action of contract, tort or otherwise, arising from, out of or in connection with the software or the use or other dealings in the software.

Except as contained in this notice, the name of a copyright holder shall not be used in advertising or otherwise to promote the sale, use or other dealings in this Software without prior written authorization of the copyright holder.

unzip

This is version 2005-Feb-10 of the Info-ZIP copyright and license. The definitive version of this document should be available at <ftp://ftp.info-zip.org/pub/infozip/license.html> indefinitely.

Copyright (c) 1990-2005 Info-ZIP. All rights reserved.

For the purposes of this copyright and license, "Info-ZIP" is defined as the following set of individuals:

Mark Adler, John Bush, Karl Davis, Harald Denker, Jean-Michel Dubois, Jean-loup Gailly, Hunter Goatley, Ed

Gordon, Ian Gorman, Chris Herborth, Dirk Haase, Greg Hartwig, Robert Heath, Jonathan Hudson, Paul Kienitz, David Kirschbaum, Johnny Lee, Onno van der Linden, Igor Mandrichenko, Steve P. Miller, Sergio Monesi, Keith Owens, George Petrov, Greg Roelofs, Kai Uwe Rommel, Steve Salisbury, Dave Smith, Steven M. Schweda, Christian Spieler, Cosmin Truta, Antoine Verheijen, Paul von Behren, Rich Wales, Mike White.

This software is provided "as is," without warranty of any kind, express or implied. In no event shall Info-ZIP or its contributors be held liable for any direct, indirect, incidental, special or consequential damages arising out of the use of or inability to use this software.

Permission is granted to anyone to use this software for any purpose, including commercial applications, and to alter it and redistribute it freely, subject to the following restrictions:

1. Redistributions of source code must retain the above copyright notice, definition, disclaimer, and this list of conditions.
2. Redistributions in binary form (compiled executables) must reproduce the above copyright notice, definition, disclaimer, and this list of conditions in documentation and/or other materials provided with the distribution. The sole exception to this condition is redistribution of a standard UnZipSFX binary (including SFXWiz) as part of a self-extracting archive; that is permitted without inclusion of this license, as long as the normal SFX banner has not been removed from the binary or disabled.
3. Altered versions—including, but not limited to, ports to new operating systems, existing ports with new graphical interfaces, and dynamic, shared, or static library versions—must be plainly marked as such and must not be misrepresented as being the original source. Such altered

versions also must not be misrepresented as being Info-ZIP releases—including, but not limited to, labeling of the altered versions with the names “Info-ZIP” (or any variation thereof, including, but not limited to, different capitalizations), “Pocket UnZip,” “WiZ” or “MacZip” without the explicit permission of Info-ZIP. Such altered versions are further prohibited from misrepresentative use of the Zip-Bugs or Info-ZIP e-mail addresses or of the Info-ZIP URL(s).

4. Info-ZIP retains the right to use the names “Info-ZIP,” “Zip,” “UnZip,” “UnZipSFX,” “WiZ,” “Pocket UnZip,” “Pocket Zip,” and “MacZip” for its own source and binary releases.

Registered trademarks

Apple Inc.

Apple CarPlay™ is a trademark of Apple Inc.

App Store® and iTunes Store® are registered trademarks of Apple Inc.

iPhone®, iPod®, iPod touch®, iPod nano®, iPad® and Siri® are registered trademarks of Apple Inc.

Bluetooth SIG, Inc.

Bluetooth® is a registered trademark of Bluetooth SIG, Inc.

DivX, LLC

DivX® and DivX Certified® are registered trademarks of DivX, LLC.

EnGIS Technologies, Inc.

BringGo® is a registered trademark of EnGIS Technologies, Inc.

Google Inc.

Android™ and Google Play™ Store are trademarks of Google Inc.

Stitcher Inc.

Stitcher™ is a trademark of Stitcher, Inc.

Verband der Automobilindustrie e.V.

AdBlue® is a registered trademark of the VDA.

Vehicle data recording and privacy

Event data recorders

Data storage modules in the vehicle

A large number of electronic components of your vehicle contain data storage modules temporarily or permanently storing technical data about the condition of the vehicle, events and errors. In general, this technical information documents the condition of parts, modules, systems or the environment:

- operating conditions of system components (e.g. filling levels)
- status messages of the vehicle and its single components (e.g. number of wheel revolutions / rotational speed, deceleration, lateral acceleration)
- dysfunctions and defects in important system components

- vehicle reactions in particular driving situations (e.g. inflation of an airbag, activation of the stability regulation system)
- environmental conditions (e.g. temperature)

These data are exclusively technical and help identifying and correcting errors as well as optimising vehicle functions.

Motion profiles indicating travelled routes cannot be created with these data.

If services are used (e.g. repair works, service processes, warranty cases, quality assurance), employees of the service network (manufacturer included) are able to read out this technical information from the event and error data storage modules applying special diagnostic devices. If required, you will receive further information at these workshops. After an error has been corrected, the data are deleted from the error storage module or they are constantly overwritten.

When using the vehicle, situations may occur in which these technical data related to other information (accident report, damages on the vehicle, witness statements etc.) may be associated with a specific person - possibly, with the assistance of an expert.

Additional functions contractually agreed upon with the client (e.g. vehicle location in emergency cases) allow the transmission of particular vehicle data from the vehicle.

Radio Frequency Identification (RFID)

RFID technology is used in some vehicles for functions such as tyre pressure monitoring and ignition system security. It is also used in connection with conveniences such as radio remote controls for door locking/unlocking and starting, and in-vehicle transmitters for garage door openers. RFID technology in Opel vehicles does not use or record personal information or link with any other Opel system containing personal information.

Index

A

Accessories and vehicle modifications	164
Adjustable air vents	126
Airbag and belt tensioners	88
Airbag deactivation	46, 88
Airbag label.....	41
Airbag system	41
Air conditioning regular operation	127
Air conditioning system	119
Air intake	126
Air vents.....	126
Antilock brake system	139
Antilock brake system (ABS)	90
Anti-theft alarm system	27
Anti-theft locking system	27
Appearance care.....	209
Ashtrays	80
Automatic anti-dazzle	30
Automatic light control	111
Automatic locking	25
Autostop.....	131

B

Battery discharge protection	117
Battery voltage	101
Belts.....	39
Bicycle rack.....	55
Bonnet	166

Brake and clutch fluid.....	214
Brake and clutch system	89
Brake assist	140
Brake fluid	169
Brakes	139, 169
Breakdown.....	206
Bulb replacement	171

C

Capacities	227
Car Pass	22
Catalytic converter	134
Central locking system	23
Changing tyre and wheel size ...	193
Charging system	88
Child restraint installation locations	50
Child restraints.....	48
Child restraint systems	48
Cigarette lighter	80
City mode.....	143
Climate control	17
Climate control systems.....	118
Clock	77
Code.....	99
Collision damage repair.....	233
Colour-Info-Display.....	97
Control indicators.....	85
Control of the vehicle	128
Controls.....	73

Convex shape	29
Coolant and antifreeze.....	214
Cruise control	92, 145
Cupholders	53
Curtain airbag system	46

D

Danger, Warnings and Cautions ...	4
Daytime running lights	112
Declaration of conformity.....	230
Door open	92
Doors.....	26
Driver assistance systems.....	145
Driver Information Centre.....	92
Driving hints.....	128

E

Electric adjustment	29
Electrical system.....	181
Electronic climate control system	121
Electronic driving programmes ..	138
Electronic Stability Control.....	142
Electronic Stability Control and Traction Control system.....	90
Electronic Stability Control off.....	90
End-of-life vehicle recovery	165
Engine compartment fuse box ...	182
Engine coolant	168
Engine coolant temperature gauge	83
Engine data	222

Engine exhaust	134
Engine identification.....	218
Engine oil	167, 214, 219
Engine oil pressure	91
Entry lighting	116
Event data recorders.....	236
Exit lighting	116
Exterior care	209
Exterior light	92
Exterior lighting	14, 110
Exterior mirrors.....	29

F

Fault	138
First aid.....	69
First aid kit	69
Fixed air vents	126
Flex-Fix system.....	55
Folding mirrors	29
Front airbag system	45
Front seats.....	35
Front storage.....	54
Front turn signal lights	174
Fuel.....	158
Fuel consumption - CO ₂ - Emissions	163
Fuel for liquid gas operation.....	159
Fuel for petrol engines	158
Fuel gauge	82

Fuel selector	82
Fuses	181

G

Gauges.....	81
Glass panel	33
Glovebox	53
Graphic-Info-Display.....	98

H

Halogen headlights	171
Hand brake.....	139, 140
Hazard warning flashers	112
Headlight flash	111
Headlight range adjustment	112
Headlights.....	110
Headlights when driving abroad	112
Head restraint adjustment	8
Head restraints	34
Heated mirrors	29
Heated rear window	32
Heated steering wheel	73
Heating	38
Heating and ventilation system .	118
High beam	92, 111
Hill start assist	140
Horn	15, 74

I

Identification plate	218
Ignition switch positions	129

- Immobiliser 28, 92
 Indicators..... 81
 Inductive charging..... 79
 Information displays..... 92
 Instrument cluster 81
 Instrument panel fuse box 184
 Instrument panel illumination 180
 Instrument panel illumination control 114
 Instrument panel overview 10
 Interior care 211
 Interior lighting..... 114
 Interior lights 114, 180
 Interior mirrors..... 30
 Introduction 3
- J**
- Jump starting 205
- K**
- Key, memorised settings..... 23
 Keys 21
 Keys, locks..... 21
- L**
- Lashing eyes 68
 Light switch 110
 Load compartment 26, 64
 Load compartment cover 66
 Loading information 70
- Low fuel 91
 LPG..... 82, 159, 219
- M**
- Malfunction indicator light 89
 Manual anti-dazzle 30
 Manual mode 138
 Manual transmission 135
 Manual transmission automated 135
 Memorised settings..... 23
 Midlevel-Display..... 92
 Mirror adjustment 8
 Misted light covers 114
- N**
- New vehicle running-in 129
 Number plate light 179
- O**
- Object detection systems..... 148
 Odometer 81
 Oil, engine..... 214, 219
 OnStar..... 106
 Operate pedal..... 89
 Outside temperature 76
 Overrun cut-off 130
- P**
- Parking 20, 133
 Parking assist 148
 Parking brake 140
- Parking lights 113
 Performance 224
 Performing work 166
 Pollen filter 126
 Power outlets 78
 Power steering..... 90
 Power windows 30
 Puncture..... 198
- R**
- Radio Frequency Identification (RFID)..... 236
 Radio remote control 22
 REACH..... 233
 Rear carrier system..... 55
 Rear floor storage cover 67
 Rear fog light 92
 Rear fog lights 113
 Rear storage..... 65
 Rear window wiper/washer 75
 Recommended fluids and lubricants 214, 219
 Refuelling 160
 Registered trademarks..... 235
 Retained power off..... 129
 Reversing lights 114
 Ride control systems..... 141
 Roof load..... 70
 Roof rack 69

S		
Safety belts.....	39	
Seat adjustment	7, 36	
Seat belt	8	
Seat belt reminder	87	
Seat belts	39	
Seat folding	37	
Seat heating.....	38	
Seat position	35	
Selector lever	136	
Service	127	
Service display	84	
Service information	213	
Service vehicle soon	89	
Side airbag system	45	
Side blind spot alert.....	157	
Sidelights.....	110	
Side turn signal lights	179	
Software acknowledgement.....	234	
Spare wheel	201	
Speed limiter.....	146	
Speedometer	81	
Starting and operating.....	129	
Starting off	18	
Starting the engine	130, 136	
Steering.....	129	
Steering wheel adjustment	9, 73	
Steering wheel controls	73	
Stop-start system.....	131	
Storage.....	53	
Storage compartments.....	53	
Sunroof	32	
Sun visors	32	
Symbols	4	
T		
Tachometer	81	
Tail lights	175	
Three-point seat belt	40	
Tools	186	
Towing.....	206	
Towing another vehicle	208	
Towing the vehicle	206	
Traction Control system	141	
Transmission	18	
Transmission display	136	
Tread depth	193	
Trip odometer	81	
Turn and lane-change signals ...	113	
Turn signal	87	
Tyre chains	194	
Tyre designations	188	
Tyre pressure	188	
Tyre pressure monitoring system.....	91, 189	
Tyre pressures	228	
Tyre repair kit	194	
U		
Ultrasonic parking assist	90, 148	
Upholstery.....	211	
Uplevel-Display.....	92	
Upshift.....	90	
Using this manual	3	
V		
Vehicle battery	169	
Vehicle checks.....	166	
Vehicle data.....	219	
Vehicle data recording and privacy.....	236	
Vehicle dimensions	226	
Vehicle Identification Number	217	
Vehicle jack.....	186	
Vehicle messages	99	
Vehicle personalisation	102	
Vehicle security.....	27	
Vehicle specific data	3	
Vehicle storage.....	165	
Vehicle tools.....	186	
Vehicle unlocking	6	
Vehicle weight	225	
Ventilation.....	118	
W		
Warning chimes	101	
Warning lights.....	81	
Warning triangle	68	
Washer and wiper systems	16	
Washer fluid	168	
Wheel changing	198	
Wheel covers	193	

Wheels and tyres	187
Windows.....	30
Windscreen.....	30
Windscreen wiper/washer	74
Winter tyres	187
Wiper blade replacement	171

www.opel.com

Copyright by ADAM OPEL GmbH, Rüsselsheim, Germany.

The information contained in this publication is effective as of the date indicated below. Adam Opel GmbH reserves the right to make changes to the technical specifications, features and design of the vehicles relative to the information in this publication as well as changes to the publication itself.

Edition: August 2017, ADAM OPEL GmbH, Rüsselsheim.

Printed on chlorine-free bleached paper.

ID-OADAOBSE1708-en

