Contents

In brief	1-1
Keys, doors and windows	2-1
Seats, restraints and interior	3-1
Storage compartments.....	4-1
Instruments and controls.....	5-1
Lighting	6-1
Infotainment system.....	7-1
Climate controls	8-1
Driving and operating.....	9-1
Vehicle care	10-1
Service and maintenance	11-1
Technical data.....	12-1
Index	13-1

Introduction

Vehicle specific data

Please enter your vehicle's data here to keep it easily accessible. This information is available under the chapters "Service and maintenance" and "Technical data" as well as on the identification plate.

Fuel

Designation

Engine oil

Grade

Viscosity

Tyre pressure

	Tyre size	with up to 3 persons		with full load	
Summer tyres	<input type="text"/>	Front <input type="text"/>	Rear <input type="text"/>	Front <input type="text"/>	Rear <input type="text"/>
Winter tyres	<input type="text"/>	Front <input type="text"/>	Rear <input type="text"/>	Front <input type="text"/>	Rear <input type="text"/>

Weights

Permissible Gross Vehicle Weight

- EC kerb weight

= Payload

Introduction

Your vehicle is an intelligent combination of forward-looking technology, impressive safety, environmental friendliness and economy.

It now lies with you to drive your vehicle safely and ensure that it performs perfectly. This Owner's Manual provides you with all the necessary information to that end.

Make sure your passengers are aware of the possible risk of accident and injury which may result from improper use of the vehicle.

You must always comply with the specific laws of the country that you are travelling through. These laws may differ from the information in this Owner's Manual.

When instructed to seek the assistance of a workshop, we recommend that you consult an Opel Service Partner. All Opel Service Partners offer first-class service at reasonable prices. Experienced

mechanics, trained by Opel, work according to specific Opel instructions.

The Owner's Manual and the Service and Warranty Booklet should always be kept ready to hand in the glove box.

Make use of the Owner's Manual

- The "In brief" chapter will give you an initial overview.
- The table of contents at the beginning of the Owner's Manual and within the individual chapters will show you where everything is.
- Its index will help you find what you want.
- Yellow arrows in the illustrations serve as points of reference or indicate some action to be performed.
- Black arrows in the illustrations indicate a reaction or a second action to be performed.

- This Owner's Manual depicts left-hand drive vehicles. Operation is similar for right-hand drive vehicles.
- The Owner's Manual uses the internal engine codes. The corresponding sales designations are found in the chapter "Technical data".
- Directional data, e.g. left or right, or front or back, in the descriptions always relate to the direction of travel.

Danger, **Warning**, **Caution**

Danger

Text marked  **Danger** provides information on risk of fatal injury. Disregard of these instructions may endanger life.

Warning

Text marked  **Warning** provides information on risk of accident or injury. Disregard of these instructions may result in injuries.

Caution

Text marked **Caution** provides information on possible damage to the vehicle. Disregard of these instructions may lead to vehicle damage.

Symbols

The asterisk * signifies equipment not fitted to all vehicles (model variants, engine options, models specific to one country, optional equipment, genuine parts and accessories).

Page references are indicated with ↪.
↪ means “see page”.

We wish you many hours of pleasurable driving

Adam Opel GmbH

In brief

The most important information for your first journey.



S 14906

To unlock and open the vehicle: Press button  on remote control * or unlock with the key, pull door handle

Door locks ⇨ 2-3, 5-12, keys ⇨ 2-1, immobiliser ⇨ 2-7, radio remote control ⇨ 2-1, central locking system ⇨ 2-3, anti-theft locking system ⇨ 2-6.



S 14885

To unlock and open the tailgate: Press button  on remote control * or unlock with the key, operate button below the handle

Tailgate ⇨ 2-5, radio remote control ⇨ 2-1, central locking system ⇨ 2-3.



S 14886

Longitudinal seat adjustment: Pull handle, slide seat, release handle

Seats ⇨ 3-2.



S 14886

Reclining seatbacks: Raise release lever

Move seatback to suit seating position.

Do not lean on seatback whilst adjusting it.

Seats ⇨ 3-2.



S 14887

Adjusting seat height *: Raise or lower lever

Lever pumping action

Upwards: Raises seat

Downwards: Lowers seat

Seats ⇨ 3-2.



Adjusting head restraint height: Press catch, adjust height, then release

Head restraints ⇨ 3-1.



Fitting seat belt: Pull belt out evenly from retractor, guide over shoulder and engage in buckle

The seat belt must not be twisted at any point. The lap belt must lie snugly against the body.

The seatbacks must not be tilted back too far (recommended maximum tilting angle approx. 25°).

To release seat belt, press red button on belt buckle.

Seat belts ⇨ 3-5 to 3-8, airbag system ⇨ 3-13, seat position ⇨ 3-2.



To adjust interior mirror: Swivel mirror housing

Swivel lever on underside of mirror housing to reduce dazzle at night.

Take care when driving with interior mirror adjusted for night vision. Rear view may be slightly distorted in this position.

Further information ⇨ 2-9.



Adjusting manual exterior mirrors: Swivel lever in required direction

Exterior mirrors ⇨ 2-8, heated exterior mirrors ⇨ 2-9, 8-5.



Adjusting power exterior mirrors *: Four-way switch in driver's door

Select corresponding mirror and adjust.

Exterior mirrors ⇨ 2-8, heated exterior mirrors ⇨ 2-9, 8-5.

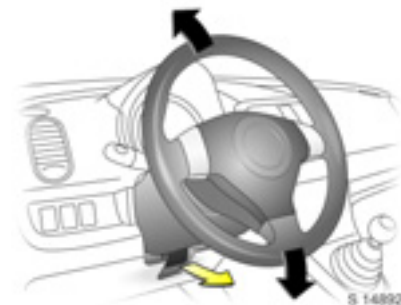

To adjust steering wheel *: Pull lever forwards, adjust height, push lever back and engage

Adjust steering wheel only with vehicle stationary and steering column lock released.

Airbag system ⇨ 3-13, further information ⇨ 5-1.

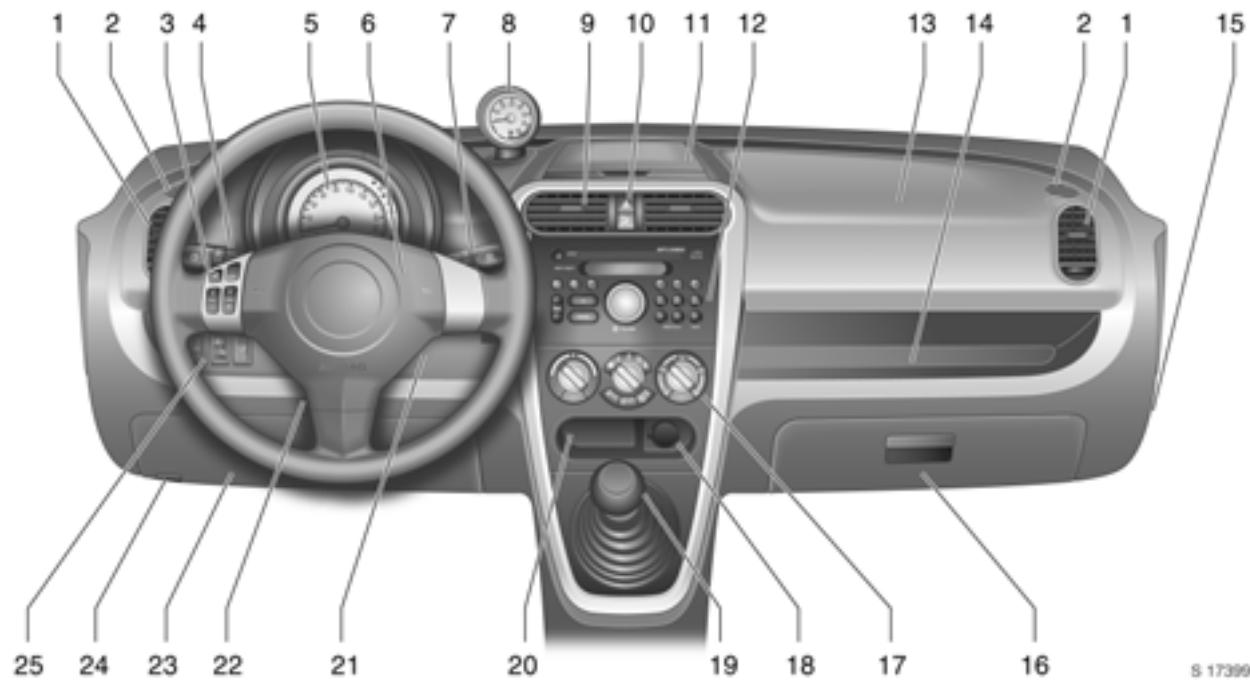



- | | | |
|--|---|--|
| <p>1 Side air vents ⇨ 8-5</p> <p>2 Door window defroster vents ⇨ 8-5</p> <p>3 Steering wheel mounted remote control * ⇨ 7-2</p> <p>4 Parking lamps ⇨ 6-1
 Turn signal lamps ⇨ 6-2
 High beam ⇨ 6-2
 Dipped beam ⇨ 6-2
 Headlamp flash ⇨ 6-2
 Rear fog lamp ⇨ 6-3</p> <p>5 Central information display for time and outside temperature ⇨ 5-3, 5-4
 Instrument cluster ⇨ 5-8
 Speedometer ⇨ 5-5
 Odometer ⇨ 5-6
 Fuel gauge ⇨ 5-7
 Service interval display * ⇨ 5-14
 Transmission display * ⇨ 5-7
 Trip computer * ⇨ 5-14</p> | <p>6 Driver's airbag ⇨ 3-13
 Horn ⇨ 5-2</p> <p>7 Windscreen wiper/washer ⇨ 5-2
 Rear window wiper/washer ⇨ 5-3</p> <p>8 Tachometer ⇨ 5-6</p> <p>9 Centre air vents ⇨ 8-4</p> <p>10 Hazard warning ⇨ 6-2
 Control indicator for front passenger airbag deactivation * ⇨ 3-18</p> <p>11 Upper tray ⇨ 4-2</p> <p>12 Infotainment system ⇨ 7-1</p> <p>13 Front passenger's airbag ⇨ 3-13</p> <p>14 Storage tray ⇨ 4-2</p> <p>15 Passenger airbag deactivation switch * ⇨ 3-17</p> <p>16 Glove box ⇨ 4-1</p> <p>17 Climate controls ⇨ 8-1</p> <p>18 Power outlet ⇨ 5-4
 Cigarette lighter * ⇨ 5-5</p> | <p>19 Gearshift lever ⇨ 9-4, 9-6</p> <p>20 Storage tray</p> <p>21 Ignition switch ⇨ 9-1</p> <p>22 Steering wheel adjustment ⇨ 5-1</p> <p>23 Fuse box ⇨ 10-12</p> <p>24 Bonnet release ⇨ 10-2</p> <p>25 Front fog lamps * ⇨ 6-3
 Headlamp range adjustment * ⇨ 6-1
 TCSS deactivation * ⇨ 9-11</p> |
|--|---|--|



S 17391

Exterior lamps controls:

Turn light switch:

-  = Dipped beam or high beam
-  = Parking lamps
- OFF = Off

Turn adjustment band:

-  = Rear fog lamp
- OFF = Off

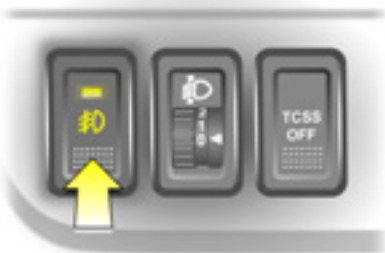

S 14872

Press button:

 = Front fog lamps *

Headlamp warning device ⇨ 5-13, further information ⇨ 6-1, headlamp range adjustment ⇨ 6-1, fog lamps ⇨ 6-3, headlamps when driving abroad ⇨ 6-3.



S 17393

Headlamp flash, high beam and dipped beam:

- Headlamp flash = Pull lever towards steering wheel
- High beam = Push lever forwards
- Dipped beam = Pull lever back towards steering wheel

Further information ⇨ 6-2.



S 17392

Turn signal lamps:

Upwards = Right turn

Downwards = Left turn

Further information ⇨ 6-2.



S 14874

Hazard warning lamps:

On = Press ▲

Off = Press ▲ again



S 17398

Horn: Press 📄

Airbag system ⇨ 3-13, remote control on steering wheel ✱ ⇨ 5-1, 7-2.



S 17387

Windscreen wipers:

- MIST = Misting function
- OFF = Off
- INT = Timed interval wipe *
- LO = Slow
- HI = Fast

Move lever up from position OFF:
Single swipe.

Windscreen wipers ⇨ 5-2, further
information ⇨ 10-5, 10-30, 10-31.



S 17388



Windscreen washer system: Pull lever towards steering wheel

Windscreen washer system ⇨ 5-3,
further information ⇨ 10-5, 10-30,
10-31.



S 17389



Rear window wiper and washer systems: Rotate end of lever

-  = Washer
- ON = Wiper on
- INT = Timed interval wipe *
- OFF = Wiper off
-  = Washer

Rear window wiper/washer systems
⇨ 5-3, further information ⇨ 10-5, 10-
30, 10-31.

Parking the vehicle:

- Apply the parking brake firmly without actuating the release button. On a downhill or uphill slope, apply as firmly as possible. Depress foot brake at the same time to reduce operating forces.
- Push key into ignition switch before turning to LOCK position and removing (vehicles with automatic transmission *: depress foot brake and shift into **P**). Turn steering wheel until lock is felt to engage (anti-theft protection).
- If the vehicle is parked on a level surface or a hill, select 1st gear before switching the ignition off, (vehicles with automatic transmission *: shift into **P**). Also turn front wheels away from kerb if parked on an uphill slope.
- If the vehicle is parked on a downhill slope, select reverse gear before switching the ignition off, (vehicles with automatic transmission *: shift into **P**). Also turn front wheels towards kerb.

- Lock doors and tailgate by pressing button  on the radio remote control *. Press button  twice within 3 seconds to activate the anti-theft locking system *.

Advice when parking:

- Do not park the vehicle on an easily ignitable surface. The high temperature of the exhaust system could ignite the surface.
- Close the windows.
- The engine cooling fans may run after the engine has been switched off ⇨ 10-1.

Radio remote control * ⇨ 2-1,
central locking system ⇨ 2-3.

Keys, doors and windows

Keys and locks	2-1
Doors.....	2-5
Vehicle security	2-6
Exterior mirrors.....	2-8
Interior mirror.....	2-9
Windows.....	2-10

Keys and locks

Keys

The key number is specified on the keys or on a key number tag ✱. Remove key number tag from keys and make a note of the number.

The key is a constituent of the immobiliser ✱. In case of loss, replacement keys can be ordered from your Opel Service Partner by quoting the key number.

Ordering keys from an Opel Service Partner guarantees problem-free operation of the immobiliser ✱.

Keep spare key in a safe place.

Locks ⇨ 10-30.

Radio remote control ✱

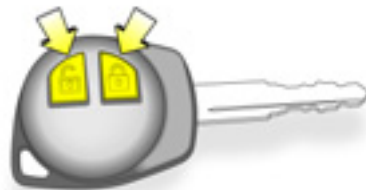

S 14903

The remote control is used to operate:

- Central locking system,
- Anti-theft locking system ✱.

The remote control has a range of approx. 5 metres. The range may be reduced due to environmental conditions or shadowing and reflection of the radio waves.

Treat the remote control unit with care: it should be protected against moisture, kept out of direct sunlight and should not be operated unnecessarily.

Fault

If the central locking system cannot be operated with the remote control, this may be due to the following reasons:

- The remote control is out of range.
- The battery voltage of the remote control is too low. Change the battery in the remote control unit.
- Interference from higher power radio waves from other sources.

Lock or unlock the doors manually using the key or central locking switch
 ⇨ 2-3, 2-4.

Seek the assistance of a workshop to rectify the cause of the fault.

Changing battery in remote control unit

Replace the battery (CR 1620 or equivalent) in accordance with the chapter "Service and maintenance"
 ⇨ 11-2 or when the range of the remote control starts to become reduced.

Remove screw on key cover and remove the transmitter.

Prise apart both halves of transmitter with a suitable screwdriver.

Replace battery, ensuring the new battery is installed correctly with positive (+) side facing the positive (+) terminal.

Reattach both halves of transmitter and reinstall in holder, ensuring it engages correctly.

Replace cover and tighten screw.

Battery disposal

Batteries are not to be treated as household waste. They should be disposed of at a designated collection point for recycling.

Door locks

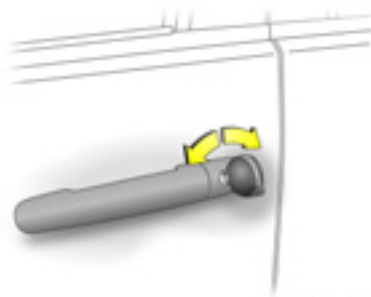

S 14899

The front doors may be manually locked and unlocked using the key.

On vehicles with central locking system ✱, the entire vehicle can be unlocked by turning the key twice in the driver's door lock.

The tailgate is unlocked when the driver's door is opened.



S 14900

To lock or unlock doors from inside the vehicle, press the interior lock.

To lock front doors from outside the vehicle, press the interior lock and keep exterior door handle raised when closing the door.

Central locking system ✱

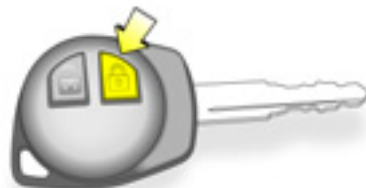

S 14884

For front doors, rear doors and tailgate.

To lock:

Press button  on remote control:

■ Hazard warning lamps flash once.

All doors and the tailgate are locked.

Always ensure that the doors, bonnet, tailgate and windows are properly closed before locking the vehicle.



S 14906

To unlock driver's door only:
Press button  on remote control once:

- Hazard warning lamps flash twice.

To unlock entire vehicle:
Press button  on remote control twice:

- Hazard warning lamps flash twice with each press.

If no door is opened within approx. 30 seconds after the vehicle has been unlocked via the remote control, the vehicle is relocked automatically.

Warning

For safety reasons, the vehicle cannot be locked or unlocked via the remote control if the key is in the ignition switch.

The vehicle can also be manually locked and unlocked by turning the key in the driver's door lock.

Central locking switch 



S 14907

Use the central locking switch to lock or unlock the doors and tailgate from inside the vehicle.

Press the front part of the switch to lock or the rear part of the switch to unlock all doors and tailgate.

Safety locks



S 14911

Warning

Use the safety locks whenever children are occupying the rear seats.

To engage lock, open door and move lock lever to lower position. Door cannot then be opened from inside.

2-5 Keys, doors and windows

To disengage safety lock, raise lock lever.

Lockout protection

To prevent the driver from being inadvertently locked out, the driver's door cannot be locked when it is open.

Doors

Tailgate

To open



The tailgate can be opened by operating the button below the handle and lifting the tailgate.

If the tailgate is open when the ignition is switched on, control indicator  illuminates in the instrument cluster.

Warning

Do not drive with tailgate open or ajar, e.g. when transporting bulky objects, since toxic exhaust gases could penetrate the vehicle interior.

To close



There is a handle on the inside of the tailgate for closing the luggage compartment.

Close tailgate by pushing it down so it latches securely. Ensure tailgate is fully closed before driving.

Emergency tailgate release

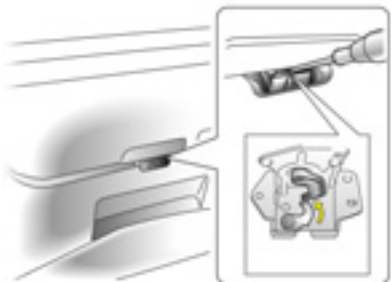

S 15165

If the central locking system * cannot be operated with the remote control, the tailgate can be opened from inside the vehicle.

Fold rear seats forward to allow access to the tailgate (↔ 3-3) and push up on emergency lever using a suitable screwdriver to open the tailgate.

Vehicle security

Anti-theft locking system *

⚠ Warning

Do not use the system if there are people in the vehicle. The doors cannot be unlocked from inside.

All doors are secured against opening and must be unlocked with the vehicle key. Unlocking is not possible in any other way, so keep spare key in a safe place.

To lock:



S 14909

All doors and the tailgate must be closed.

Press button  on remote control twice within 3 seconds:

■ Hazard warning lamps flash twice.

- or -

Turn key in driver's door lock towards rear of vehicle twice within 3 seconds.

Interior locks on all doors are positioned such that doors cannot be opened.

To unlock:

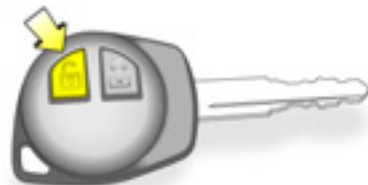

S 14906

2-7 Keys, doors and windows

To unlock driver's door only: Press button  on remote control:

- Hazard warning lamps flash twice.
- or -

Turn key in driver's door lock towards front of vehicle once.

To unlock entire vehicle: Press button  on remote control twice:

- Hazard warning lamps flash twice with each press.
- or -

Turn key in driver's door lock towards front of vehicle twice.

Immobiliser *





The system checks whether the vehicle may be started using the key that has been inserted. If the key is recognised as "authorised", the vehicle can be started. The check is carried out via a transponder housed in the key.

The immobiliser is automatically activated when the key is turned to the LOCK position and removed from the ignition switch.



The theft-deterrent control indicator starts flashing after the key is turned to positions LOCK or ACC, or removed from the ignition switch.

Fault

If control indicator  or  flashes after the ignition is switched on, there may be a fault in the immobiliser system. If the engine cannot be started:

- Turn key to LOCK position and remove,
- wait approx. 2 seconds,
- then repeat starting procedure.

If the control indicator fails to extinguish, try to start the engine using the spare key and seek the assistance of a workshop to rectify the cause of the fault.

Note

The immobiliser does not lock the doors. Therefore, after leaving the vehicle, always lock it ⇨ 2-3.

Exterior mirrors

Convex mirrors

As exterior mirrors are convex, objects are closer than they appear. Use interior mirror to judge size and distance of objects.

Manual mirrors



Adjust mirrors by swivelling lever in required direction.

Power mirrors *



Adjust with the four-way switch in driver's door: Turn selector switch to left or right; four-way outer part of switch adjusts corresponding mirror.

The mirror glass swivels in the same direction as the activation of the four-way switch.

Return the selector switch to the central position to prohibit further adjustment.

Folding mirrors



For the safety of pedestrians, the exterior mirrors will swing out of their normal mounting position in the event of an accident-like impact.

Reposition the mirror by applying slight pressure to the mirror housing.

Heated mirrors *

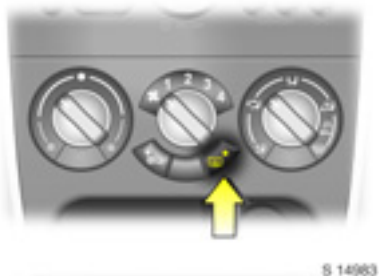

The heating operates in conjunction with the heated rear window using button .

Heated rear window, heated exterior mirrors ↻ 8-5.

Interior mirror

Manual mirror



To adjust interior mirror, swivel mirror housing.

Swivel lever on underside of mirror housing to reduce dazzle at night.

Take care when driving with interior mirror adjusted for night vision. Rear view may be slightly distorted in this position.

Windows

Manual windows



The door windows can be operated with the crank.

Power windows *

⚠ Warning

Care must be taken when operating the power windows. There is a risk of injury, particularly for children, and a danger that articles could become trapped.

If there are children on the front passenger's seat, press the  switch in the driver's door to deactivate power window operation.

Keep a close watch on the windows when closing them. Ensure that nothing becomes trapped in them as they move.

Before leaving the vehicle, remove the ignition key in order to prevent unauthorized operation.



Operational with key in ignition switch position ON.

Driver's and front passenger's door windows are operated via two switches located in the driver's door.

For incremental operation, briefly pull or press the appropriate switch.

For automatic opening of the driver's door window, press the switch down fully and release it. Pull up the switch to stop the window movement.

2-11 Keys, doors and windows



An additional switch is located in the front passenger's door.

In the event of difficulty due to frost or the like, pull the relevant window switch several times until the window is closed.

Child safety system



Press the  switch in driver's door to deactivate front passenger's door power window operation when a child is occupying the seat.

Press switch again to activate power window operation.

Sun visors

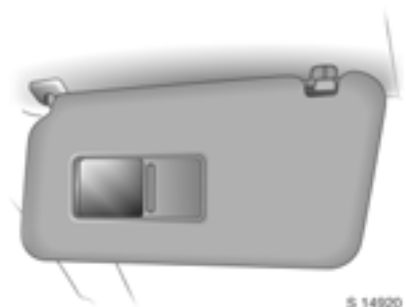

Use the sun visor to protect from glare by pulling it up, down or swivelling it to the side.

Depending on equipment version, sun visors also have vanity mirrors .

Seats, restraints and interior

Head restraints	3-1
Front seats	3-2
Rear seats	3-3
Seat belts	3-5
Child restraints	3-9
Airbag system	3-13

Head restraints

Head restraint position

⚠ Warning

Only drive with head restraints correctly adjusted.



For maximum protection, the middle of the head restraint should be at eye level. If this is not possible for extremely tall persons, set to highest position, and set to lowest position for extremely small persons.

Height adjustment



To adjust head restraint height, press catch, adjust height to suit then release the catch.

Removal

Press catch. Pull up and remove the head restraint.

Stow head restraints securely in luggage compartment.

Front seats

Seat position

Warning

Only drive with the seats correctly adjusted.



Adjust driver's seat such that, with the driver sitting upright, the steering wheel is held in the area of its upper spokes with the driver's arms slightly bent.

Slide front passenger's seat as far back as it will go.

The seatbacks must not be tilted back too far (recommended maximum tilting angle approx. 25°).

Longitudinal seat adjustment

Warning

Never adjust seats whilst driving, as they could move uncontrollably.

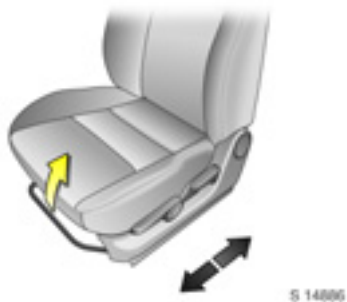

To adjust, pull the handle on the front seat, slide the seat and release the handle.

Ensure seat audibly latches into position before driving.

Reclining seatbacks



To adjust, raise the release lever, move seatback to suit seating position and release lever to lock seatback in position.

Do not lean on the seatback whilst adjusting it.

| Adjusting seat height *



S 14887

To adjust, operate lever on side of seat.

Lever pumping action

Upwards: Raises seat

Downwards: Lowers seat

Rear seats

Folding rear seatbacks

⚠ Warning

When adjusting the rear seatbacks, use caution; beware of moving parts.

The luggage compartment can be enlarged by folding the rear seatbacks onto the seat cushions.

Ensure front seats are not in reclined position and push rear seat head restraints all the way down.

When folding the rear seatbacks, ensure the seat belts are unbuckled.

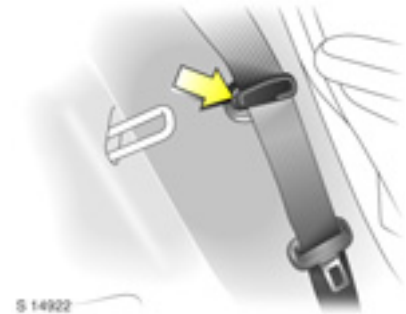

S 14922

Route outboard rear seat belts, including the latch plates, through their respective belt holders (as illustrated), ensuring they are not twisted at any point.

3-4 Seats, restraints and interior

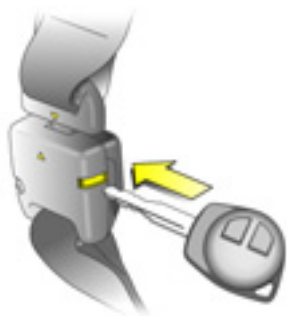

S 14928

Unlatch detachable connector on centre rear seat belt by inserting the ignition key in the slot on the connector and allow the belt to retract.

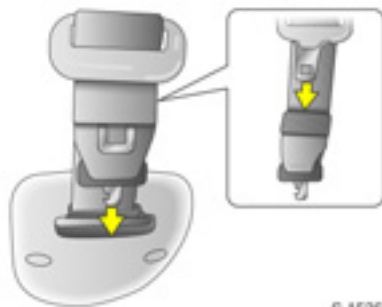

S 15361

Insert latch plate into the slit on the belt webbing and insert detached connector latch plate in roof holder slot to the rear of the belt webbing.



S 14923

To fold outboard rear seatbacks separately *, pull seatback release lever downwards, fold seatback forwards and down onto seat cushion.



To fold rear bench seat *, pull both outboard seatback release levers downwards simultaneously, fold seatback forwards and down onto seat cushion.

Do not allow passengers to sit on folded seatbacks, or place any unrestrained loads on them.

Restoring rear seatbacks

Raise seatback and push back to its original position. Ensure seatback latches into place by pushing top of seatback and pulling it forwards again.



Pull detached connector latch plate of centre rear seat belt from roof holder slot and insert in connector, with the arrows aligned. Ensure the latch plate and connector audibly engage.

Release outboard rear seat belts from their respective belt holders.

Seat belts

Three-point seat belt



The front and rear seats are equipped with three-point seat belts with automatic retractors and locking devices, allowing freedom of body movement when the vehicle moves at a constant speed, although the spring-tensioned belts are always a snug fit.

The belt has a “vehicle sensitive retractor” which is designed to lock during heavy acceleration or deceleration in any direction.

Warning

Always wear your seat belt, also in urban traffic and when you are a rear seat passenger. It can save your life!

In the event of an accident, persons not wearing seat belts endanger their fellow occupants and themselves.

Control indicator  for driver's seat belt reminder ⇨ 5-9.

Seat belts are designed to be used by only one person at a time. They are only suitable for children aged up to 12 years or smaller than 150 cm if used in conjunction with a child restraint .

Belt force limiters

Load limiters on the front seats reduce the impact on the seat occupant's body from a tensioning belt, in the event of frontal collisions or rear impacts of a certain severity. The belt force is controlled, to reduce the risk of belt-inflicted injury.

Belt tensioners

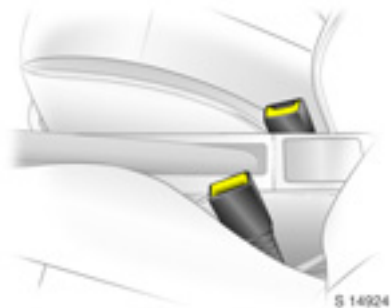

The seat belt systems on the front seats incorporate belt tensioners housed in the belt buckles and seat belt retractors.

In the event of frontal collisions or rear impacts of a certain severity, belt buckles and seat belt retractors tighten the seat belts; the shoulder and lap belts are instantaneously tightened to fit the occupant's body more snugly.

Warning

Improper handling (e.g. removal or installation) can activate the belt tensioners.

The belt tensioners actuate only once and must be replaced after activation. Seek the assistance of a workshop.

- The belt tensioners only actuate once, indicated by continuous illumination of control indicator  in the instrument cluster ⇨ 5-9. Deployed belt tensioners must be replaced. Seek the assistance of a workshop.
- Accessories not released for your vehicle type and other objects must not be fixed or placed within the action zone of the belt tensioners, as they may result in injury if the belt tensioners are triggered.

How to wear seat belts properly



Pull the belt out evenly from the retractor and guide it over the shoulder, making certain that it is not twisted at any point. The belt must not rest against your neck or arm.

The seatback must not be tilted back too far (the recommended maximum tilting angle is approx. 25°).



Insert the latch plate into the buckle. Seat belt buckles are designed such that latch plates cannot be inserted in the incorrect buckle.

The lap belt must not be twisted and must fit snugly across the body. Tension the belt frequently whilst driving by tugging the diagonal part of the belt.



The centre rear seat belt position has a twin buckle arrangement. Engage the smaller latch plate (1) into the correct buckle, then pull the belt across and audibly engage into the buckle marked CENTER (2).

⚠ Warning

The belt must not rest against hard or fragile objects in the pockets of your clothing. Do not place any objects (e.g. handbags) between the belt and your body.

Control indicator  for driver's seat belt reminder ⇨ 5-9.

Seat belt height adjustment

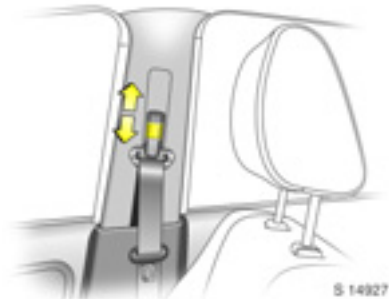

Height adjustment of front seat belt upper anchorage points.

- Do not adjust height whilst driving.
- Pull out lock knob and slide adjuster up or down to desired position.
- Ensure sliding height adjuster latches into position.

Removing the belt



To remove the belt, press the red release button on the belt buckle; the belt will retract automatically.

Guide the belt as it retracts, to prevent personal injury and damage to interior surfaces.

Seat belt use during pregnancy

⚠ Warning

On pregnant women in particular, the lap belt must be positioned as low as possible across the pelvis in order to prevent pressure on the abdomen.

Seat belt care

Periodically inspect all parts of the belt system for damage and to make sure they are functioning properly.

Have damaged parts replaced. After an accident, belts and triggered belt tensioners must be replaced by new ones.

Do not perform any alterations on the belts, their anchorages, the automatic retractors or the belt buckles.

Make sure that belts are not damaged or trapped by sharp-edged objects.

Child restraints

Child restraint systems *

When a child restraint system is being used, pay attention to the following usage and installation instructions and also those supplied with the child restraint system.

The country in which you are driving could require the use of child restraint systems at specific seats. Follow all local and national regulations.

Warning

When using a child restraint system on the front passenger's seat, the airbag systems for the front passenger's seat must be deactivated; if not, the triggering of the airbags poses a risk of fatal injury to the child.

This is especially the case if rear-facing child restraint systems are used on the front passenger's seat.

Selecting the right system

Your child should be transported facing rearwards in the vehicle for as long as possible. It is appropriate to change the system when the child's head can no longer be properly supported at eye height. The child's cervical vertebrae are still very weak and in an accident they suffer less stress in the semi-prone rearward position than when sitting upright.

- Children under 12 years or under 150 cm tall should only travel in an appropriate child safety seat.
- Never carry a child whilst travelling in the vehicle. The child will become too heavy to hold in the event of a collision.
- When transporting children, use a child restraint system that is suitable for the child's weight, age and height.
- Ensure that the child restraint system to be installed is compatible with the vehicle type.
- Ensure that the mounting location of the child restraint system within the vehicle is correct.

- Only allow children to enter and exit the vehicle at the side facing away from the traffic.
- When the child restraint system is not in use, secure the seat with a seat belt or remove it from the vehicle.
- A child restraint system which has been subjected to stress in an accident must be replaced.
- Opel produce a range of child restraint systems. We recommend you consult an Opel Service Partner.

3-10 Seats, restraints and interior

Child restraint installation locations

Mass group	Front passenger's seat		Outboard rear seats	Centre rear seat
	airbags activated	airbags deactivated		
Group 0: up to 10 kg or approx. 10 months	X	U ¹⁾	U ²⁾	X
Group 0+: up to 13 kg or approx. 18 months	X	U ¹⁾	U ²⁾	X
Group I: 9 to 18 kg or approx. 1 to 4 years	X	U ¹⁾	U ²⁾	X
Group II: 15 to 25 kg or approx. 3 to 7 years	X	X	U	X
Group III: 22 to 36 kg or approx. 6 to 12 years	X	X	U	X

¹⁾ Only if front passenger's seat airbag systems are deactivated * ⇨ 3-17.

Seat height * must be in its uppermost position ⇨ 3-3.

Group 0 and 0+: Front passenger's seat must be in its rearmost position ⇨ 3-2.

Group I: When attaching child restraints by means of three-point seat belts, seat belt must run forwards from the anchorage point ⇨ 3-8.

²⁾ Seat location with ISOFIX mountings available ⇨ 3-11.

X = Seat position not suitable for children in this mass group.

U = Suitable for 'universal' category child restraints, attached with the vehicle seat belt, approved for use in this mass group.

ISOFIX child restraint systems *

Lower ISOFIX mountings

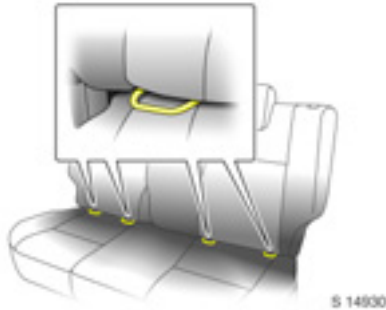

The ISOFIX mountings located between the seatback and seat cushion are used for mounting ISOFIX child restraint systems on the outboard rear seats.

The instructions accompanying the ISOFIX child restraint system are to be expressly followed.

Only ISOFIX child restraint systems approved for the vehicle may be used.

Top-Tether child restraint mountings

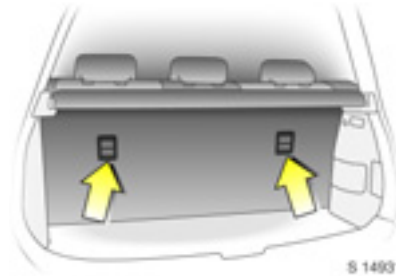

The Top-Tether mountings located on the rear of the seatbacks are designed to hold child restraints which come equipped with a top-tether mounting strap only.

Please be sure to follow the instructions provided with the child restraint system.

ISOFIX child restraint classes

The ISOFIX size class is shown on a label attached to the child restraint system.

- A =** Forward-facing child restraint for children of maximum size in the weight class 9 to 18 kg.
- B =** Forward-facing child restraint for smaller children in the weight class 9 to 18 kg.
- B1 =** Forward-facing child restraint for smaller children in the weight class 9 to 18 kg.
- C =** Rear-facing child restraint for children of maximum size in the weight class up to 13 kg.
- D =** Rear-facing child restraint for smaller children in the weight class up to 13 kg.
- E =** Rear-facing child restraint for young children in the weight class up to 13 kg.

3-12 Seats, restraints and interior

Permissible options for fitting an ISOFIX child restraint system

Mass group	ISOFIX size class	Fixture	Front passenger's seat	Outboard rear seats	Centre rear seat
Group 0: up to 10 kg or approx. 10 months	E	ISO/R1	-	IL	-
Group 0+: up to 13 kg or approx. 18 months	E	ISO/R1	-	IL	-
	D	ISO/R2	-	IL	-
	C	ISO/R3	-	IL	-
Group I: 9 to 18 kg or approx. 1 to 4 years	D	ISO/R2	-	IL	-
	C	ISO/R3	-	IL	-
	B	ISO/F2	-	IL, IUF ¹⁾	-
	B1	ISO/F2X	-	IL, IUF ²⁾	-
	A	ISO/F3	-	IL, IUF ¹⁾	-

¹⁾ Head restraint must be in its uppermost locking position or removed and stowed securely in luggage compartment.

²⁾ Head restraint must be removed and stowed securely in luggage compartment.

IL = Suitable for particular ISOFIX restraint systems of the 'specific-vehicle', 'restricted' or 'semi-universal' categories. The ISOFIX restraint system must be approved for the specific vehicle type.

IUF = Suitable for ISOFIX forward-facing child restraint systems of universal category approved for use in this mass group.

- = No ISOFIX mounting locations available at this location.

Airbag system

The airbag system consists of several individual systems.

When triggered, the driver's and front passenger's airbags inflate to form safety cushions for the driver and front passenger.

When triggered, the side airbag inflates to form a safety cushion for the driver and/or front passenger in the respective door area.

When triggered, the curtain airbag inflates to provide a safety barrier in the head area on the respective side of the vehicle.

No impairment of view will occur, as airbags inflate and deflate so quickly that they are often not noticed in an accident.

Warning

The systems can be triggered abruptly and cause injury if they are handled improperly.

- The airbag system and belt tensioner control electronics can be found in the centre console area. In order to avoid malfunctions, do not store magnetic objects in this area.
- Do not stick or place anything on the steering wheel, instrument panel, front seatbacks in the vicinity of the airbags and seat areas or cover them with other materials.
- Each airbag can be triggered only once. Once triggered, an airbag must be replaced immediately. Seek the assistance of a workshop.
- Do not perform any modifications to the components of the airbag system, as this will render the vehicle unroadworthy.
- We recommend having the steering wheel, the instrument panel, all panelling parts, the door seals, handles and the front seats removed by a workshop.

Control indicator for airbag systems
 ⇨ 5-9.

Front airbag system



S 17400

The front airbag system is identified by the words **AIRBAG** and **SRS AIRBAG** on the steering wheel and above the glove box respectively.

3-14 Seats, restraints and interior

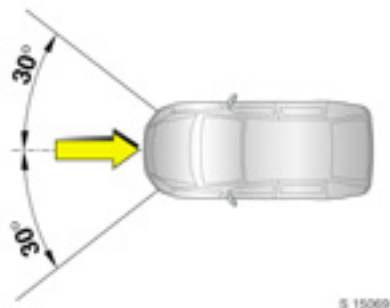

The front airbag system will be triggered depending on the severity of the accident, and within the range shown in the illustration.

The ignition must be switched on.

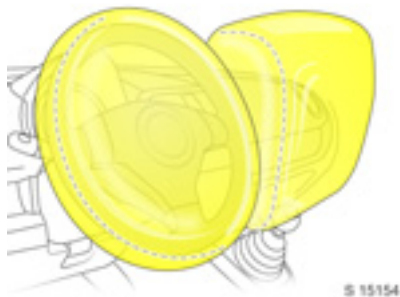

When triggered, the airbags inflate in milliseconds. Forward movement of the driver and front passenger is checked and the risk of injuries to the upper body and head are thereby substantially reduced.



⚠ Warning

The front airbag system provides optimum protection when the seat, seat belt, seatback and head restraint are correctly adjusted as described ⇨ 3-1 to 3-5.

Do not place objects, children or pets in the area in which the airbags inflate.



18533 T

⚠ Warning

The three-point seat belt must always be correctly fitted ⇨ 3-5. The front airbag system serves to supplement the three-point seat belts.

Side airbag system *

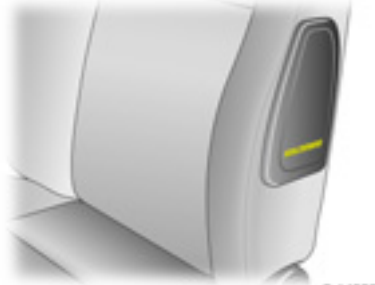

S 14933

The side airbags are identified by the words **SRS AIRBAG** on the outboard side of the front seatbacks and on the B-pillar.

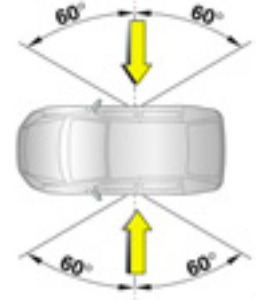

S 15070

The side airbag system will be triggered depending on the severity of the accident and within the range shown in the illustration.

The ignition must be switched on.

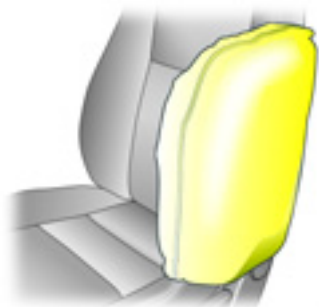

S 15155

When triggered, the airbags inflate in milliseconds. The risk of injury to the upper body and pelvis in the event of a side impact is thereby substantially reduced.

Warning

Do not place objects or parts of your body in the area in which the airbag inflates.

Note

Only install seat covers to the front seats that have been approved for your vehicle with side airbags.

Curtain airbag system *



S 14934

The curtain airbag system is identified by the words **SRS AIRBAG** on the roof frame.

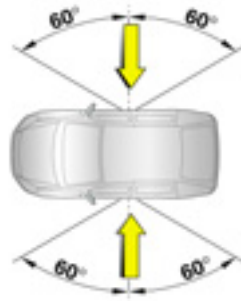

S 15079

The curtain airbag system will be triggered depending on the severity of the accident and within the range shown in the illustration.

The ignition must be switched on.



S 15153

When triggered, the airbags inflate in milliseconds. The risk of injury to the head in the event of a side impact is substantially reduced.

Warning

Do not place any objects between the airbag systems and the vehicle occupants.

Only use hooks on the handles in the roof to hang light articles of clothing or coat hangers. Do not place objects in the pockets of the hanging items.

Passenger airbag deactivation switch *

The front and side airbags for the front passenger's seat must be deactivated if a child restraint system * is to be fitted on the front passenger's seat. The curtain airbag system *, the belt tensioners and all driver's airbag systems remain active when the front passenger's airbag systems are deactivated. The front passenger's airbag systems are active in the as-delivered condition.

The deactivation switch is located on the side of the instrument panel on the front passenger's side of the vehicle.

Control indicator  illuminates in the instrument panel when the front and side airbag systems for the front passenger's seat have been deactivated.

The setting selected remains stored when the ignition is switched on.

Deactivation



S 14937

With the vehicle stationary and the ignition switched off:

- Insert ignition key in airbag deactivation switch and turn to the OFF position.

3-18 Seats, restraints and interior



- Switch on ignition; control indicator  flashes in the instrument panel then remains illuminated, to display the current status.

Airbag systems for the front passenger's seat are deactivated.

Activation

The airbag systems for the front passenger's seat must be activated when the child restraint system has been removed and the seat is occupied.

Activate the airbag systems with the vehicle stationary and the ignition switched off:

- Insert ignition key in airbag deactivation switch and turn to the ON position.
- Switch on ignition; control indicator  flashes in the instrument panel then extinguishes, to display the current status.

Airbag systems for the front passenger's seat are reactivated.

Storage compartments

Interior stowage	4-1
Luggage compartment	4-3
Roof rack system 3	4-6

Interior stowage

Glove box

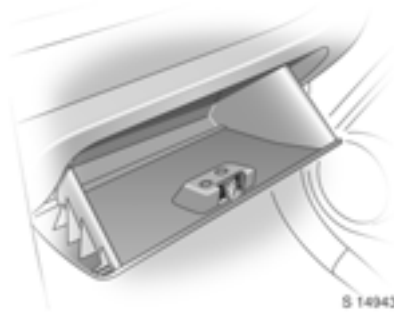

To open, pull handle.

To close, push lid until it latches into position.

Cup holders

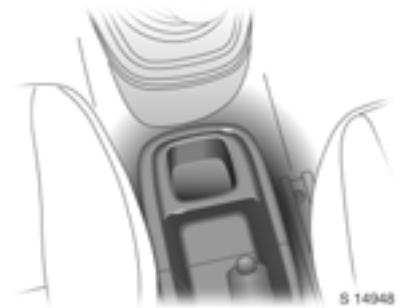

Located in the front and rear of the centre console between the front seats.

4-2 Storage compartments

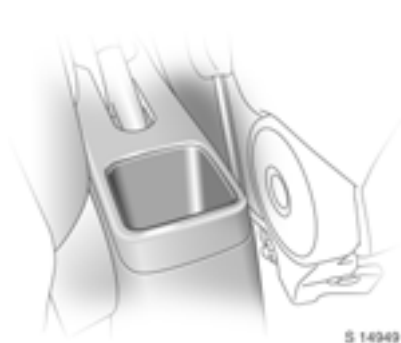

The front and rear cup holders are a fixed size.

Instrument panel storage

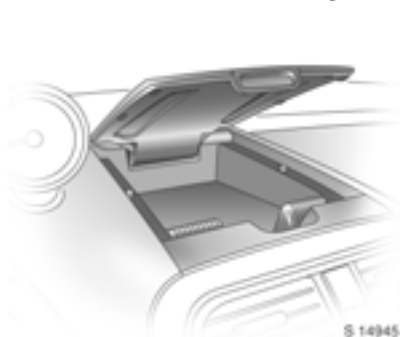

The instrument panel upper tray is located above the centre air vents.

To open, lift front edge of lid.

To close, push lid down until it latches into position.

⚠ Warning

Do not place glasses, CDs, CD cases or flammable items, e.g. cigarette lighter, in the instrument panel upper tray when parked in direct sunlight or in hot weather, as the tray can become very hot.



The front passenger's tray is located above the glove box, for storing maps, newspapers etc.

Sunglasses storage compartment *

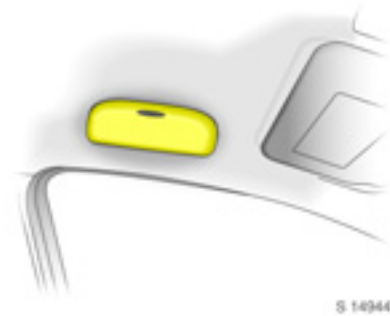

To open, pull cover down.

To close, push cover back up.

Luggage compartment



Notes on loading the vehicle

- Heavy objects in the luggage compartment should be placed as far forward as possible. If objects are to be stacked, heavier objects should be placed at the bottom.
- Secure heavy objects in luggage compartment using lashing eyes *.
- If heavy loads slip when the vehicle is braked heavily or driven around a bend, handling of the vehicle may change.

- No objects should be placed on the luggage compartment cover or the instrument panel.
- Do not allow the load to protrude above the upper edge of the rear seatbacks, or if the rear seatbacks have been folded down, above the upper edge of the front seatbacks.
- Loads must not obstruct the operation of the pedals, parking brake and gearshift lever or hinder the freedom of movement of the driver. Do not place any unsecured objects in the interior.
- Bulky objects should not be transported with the tailgate open or ajar, otherwise poisonous exhaust fumes may enter the vehicle.
- The payload is the difference between the permissible Gross Vehicle Weight (vehicle identification plate ⇨ 12-1) and the EC kerb weight.
Optional equipment and accessories increase the kerb weight and in some cases also the

4-4 Storage compartments

permissible Gross Vehicle Weight, which means that the payload will also change slightly.

According to EC Directive, the permissible Gross Vehicle Weight includes assumed weights for driver (68 kg), luggage (7 kg) and all fluids (tank 90% full).

Note the weights given on the vehicle identification plate.

- The maximum permissible roof load is 35 kg.

The roof load is the combined weight of the roof rack and the load.

Vehicle speeds in excess of 120 km/h (75 mph) are not recommended with a full roof load.

Driving hints ⇨ 9-1.

Vehicle weights ⇨ 12-7.

Luggage compartment under floor storage *

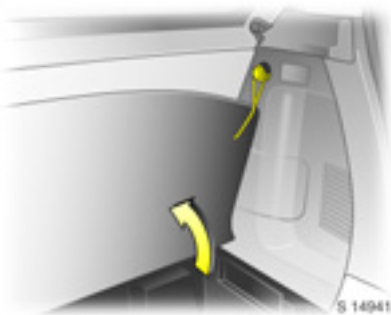

To access the under floor storage, pull up floor carpet using the central strap located near the tailgate latch and hang the string on the hook provided.

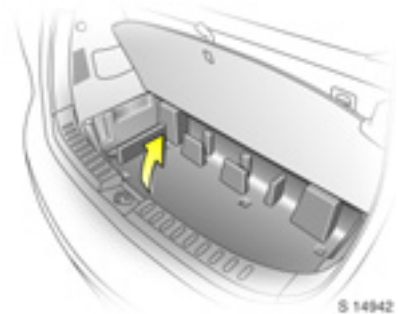

If necessary, the under floor storage compartment can be removed from the luggage compartment.

To remove, pull up by handle near the tailgate latch.

To install, fit compartment into brackets behind outboard rear seatbacks, then push down near side of compartment into clips on both sides of luggage compartment.

Do not allow objects to protrude above the top of the under floor storage.

Luggage compartment cover

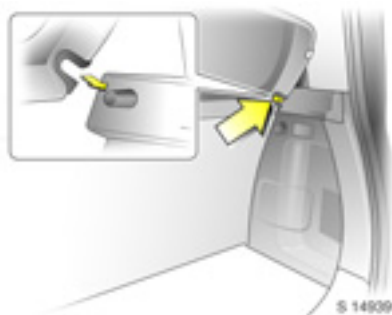

Do not place heavy objects on the cover. Loose objects should be secured safely in the luggage compartment before driving.

To remove the luggage compartment cover, pull either side of the cover from the retaining lugs.

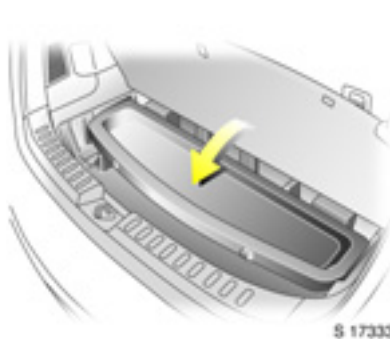

The luggage compartment cover can be stowed in the under floor storage compartment *.

Warning triangle * and first aid kit *

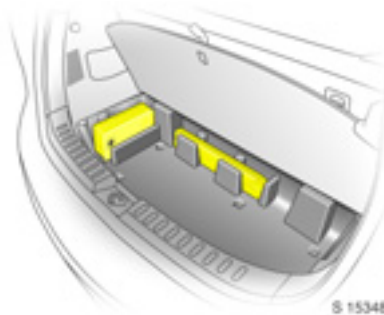

Your warning triangle and first aid kit can be accommodated below the floor cover in the luggage compartment.

Roof rack system *

For reasons of safety and to avoid damaging the roof, we recommend that you use roof rack systems approved for your vehicle.

Fasten the roof rack to the roof rails following the instructions that accompany the system, ensuring that the roof load is evenly distributed over the side or cross rails. Loads must not be placed on the roof surface.

To prevent damage or loss, check frequently that roof loads are securely fastened.

Driving with a roof load affects the vehicle's centre of gravity: drive carefully in crosswinds and do not drive at high speeds.

Driving hints ⇨ 9-1.

Instruments and controls

Horn j	5-2
Windscreen wipers.....	5-2
Windscreen washer system ..	5-3
Rear window wiper/washer ...	5-3
Clock	5-3
Outside temperature 3	5-4
Power outlets	5-4
Cigarette lighter) 3	5-5
Ashtrays 3	5-5
Warning lights, gauges and indicators	5-5
Transmission display 3	5-7
Control indicators.....	5-8
Warning chimes	5-13
Service interval display 3	5-14
Engine oil life monitor 3.....	5-14
Trip computer 3.....	5-14

Steering wheel adjustment

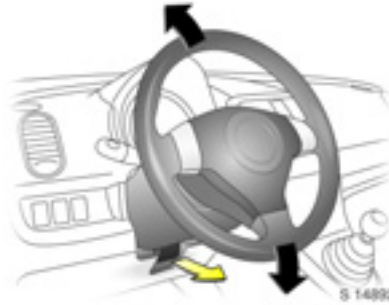

To adjust steering wheel *, pull lever forwards, adjust height, push lever back and engage.

Adjust steering wheel only with vehicle stationary and steering column lock released.

Push the lever firmly backwards to ensure that the steering wheel is locked in position.

Steering wheel mounted remote control *



The functions of the Infotainment system can be operated with the buttons on the steering wheel.

Further information ⇨ 7-2.

Horn



To activate horn, press steering wheel.

Windscreen wipers



To activate, move lever:

- MIST = Misting function
- OFF = Off
- INT = Timed interval wipe *
- LO = Slow
- HI = Fast

Move lever up from position OFF:
Single swipe.

Adjustable wiper interval *



Set the lever to adjustable timed interval wiper position INT.
Rotate INT TIME adjustment band upwards for more frequent wiping and rotate it downwards for less frequent wiping.

Windscreen washer system



S 17388

To activate, pull lever towards steering wheel. Washer fluid is sprayed onto the windscreen.



In vehicles with timed interval wipe position INT ✱, the wipers switch on automatically at low speed if they are not already activated.

Rear window wiper/washer



S 17389

To activate wiper and washer, rotate end of lever:

-  = Washer
- ON = Wiper on
- INT = Timed interval wipe ✱
- OFF = Wiper off
-  = Washer

Washer fluid is sprayed on to rear window when the end of the lever is turned to position . When the lever is released, it will spring back to the ON/OFF position.

Further information ⇨ 10-5, 10-30, 10-31.

Clock



S 14960

The time is shown in the odometer display when the ignition is switched on.

Correcting time

To set the clock, press and hold the  button for approx. 2 seconds; clock display now in setting mode.

Minute display flashes.

Press  to set minutes.

5-4 Instruments and controls

Release \ominus for approx. 5 seconds to set minute display.

Hour display flashes.

Press \ominus to set hours.

Release \ominus for approx. 5 seconds to set hour display.

Outside temperature ❄



The outside temperature is shown in the odometer display when the ignition is switched on.

If outside temperature drops to near freezing point (0 °C), the symbol ❄ illuminates in the odometer display as a warning for icy road surfaces.

⚠ Warning

The road surface may already be icy, even though the display indicates a few degrees above 0 °C.

Power outlets



Located on the instrument panel, below the climate control switches.

Operational with ignition switch in positions ACC or ON.

Pull the cap out to use the accessory socket, and replace it when not in use.

The use of non-authorized accessories may cause damage to the socket.

Use of accessory sockets while the engine is not running will discharge the battery.

The maximum power requirement of electrical accessories must not exceed 120 watts.

Do not connect any current delivering accessories, e.g. electrical charging devices or batteries.

Connected electrical accessories must comply with the EC standard in terms of electromagnetic compatibility requirements laid down in DIN VDE 40 839, otherwise vehicle malfunctions may occur.

Cigarette lighter *

With ignition switch in positions ACC or ON, push the cigarette lighter in all the way and release it.

Heating up ceases once element is glowing; cigarette lighter pops up automatically. Withdraw lighter.

Ashtrays *

Warning

To be used only for ash and not for combustible rubbish.

Portable ashtray

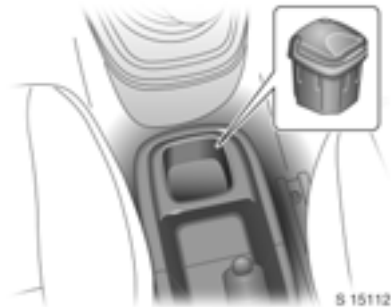

The portable ashtray can be fitted in the front or rear cup holder in the centre console.

Warning lights, gauges and indicators

Speedometer



Indicates the vehicle speed.

Odometer



The odometer indicates how far the vehicle has been driven.

Trip odometer

There are two independent trip odometers which indicate how far the vehicle has been driven since the last reset.

Press the **MODE** button repeatedly until **A** or **B** appears on the left of the odometer display.

To reset a trip odometer, press and hold the **MODE** button for approx. 2 seconds while the relevant trip odometer is displayed.

Odometer display brightness



To change brightness level, switch on headlamps and press the **MODE** button repeatedly until the squares that indicate the brightness level appear in the odometer display. Then press and hold the **MODE** button to cycle through brightness levels.

Four squares indicates maximum brightness, while one square indicates the minimum brightness level.

Tachometer



Indicates the engine speed.

Caution

Pointer in warning zone; maximum permissible engine speed exceeded, danger to engine.

Fuel gauge



Indicates fuel level when the ignition is on (**F** indicates full, **E** indicates empty).

When fuel gauge indicates that fuel supply is low (one segment on the gauge is illuminated), fill up fuel tank as soon as possible. If control indicator  illuminates in the instrument cluster, refuel immediately.

Never let the fuel tank become empty. Diesel engines: if the tank has been run dry, bleed the fuel system  10-7.

Because of the amount of fuel remaining in the tank, the amount of fuel required to fill the tank may be less than the specified tank capacity. Refuelling  9-12.

Transmission display *



Display of the selected gear or mode with automatic transmission.

P	Park position
R	Reverse gear
N	Neutral
D	Automatic mode
3, 2, L	Selected gear

Automatic transmission  9-3.

Instrument cluster



S 14953

Control indicators

The control indicators described here are not present in all vehicles. The description applies to all instrument versions.

The colours of the control indicators mean:

- Red Danger, important reminder.
- Yellow Warning, information, fault.
- Green Confirmation of activation.
- Blue Confirmation of activation.

Driver's seat belt

Will illuminate in red when ignition is switched on if driver's seat belt is not engaged.

If vehicle speed exceeds 15 km/h (9 mph) and driver's seat belt is not engaged, the control indicator will flash for approx. 90 seconds along with a warning chime and then illuminate until driver's seat belt is fastened correctly.

Seat belts ⇨ 3-5.

Airbag systems, belt tensioners

Will flash in red several times when the ignition is switched on, then extinguish.

If it does not flash when the ignition is switched on, stays lit, illuminates or flashes whilst driving, there is a fault with the airbag systems or with the belt tensioners. The systems might not therefore be triggered in the event of an accident. Seek the assistance of a workshop immediately.

Belt tensioners ⇨ 3-6, airbags ⇨ 3-13.

Charging system

Will illuminate in red when ignition is switched on. Extinguishes after engine is started.

If it stays lit after the ignition is switched on or illuminates during driving: stop vehicle and switch off engine. The battery is not being charged and the engine cooling may be interrupted. The brake servo unit may cease to be effective. Interrupt your journey immediately.

Remove ignition key and check drive belt condition and tensioning before seeking the assistance of a workshop.

Service transmission *

Will illuminate briefly in yellow when the ignition is switched on.

If it flashes, there is a fault in the automatic transmission. Seek the assistance of a workshop immediately.

Automatic transmission ⇨ 9-3.

Brake system

Will illuminate in red when ignition is switched on. Extinguishes after engine is started.

Illuminates when engine is running if parking brake is applied and/or fluid level for brake hydraulics is too low.

Caution

If it illuminates when the parking brake is not applied: stop vehicle; interrupt your journey immediately. Seek the assistance of a workshop.

Further information ⇨ 9-9, brake fluid level ⇨ 10-6.

Anti-lock Brake System (ABS)

Will illuminate briefly in yellow when ignition is switched on.

At the same time, the system performs a self-check. When the control indicator extinguishes, the system is ready for operation.

If it does not illuminate when the ignition is switched on, stays lit or illuminates during driving, there is a fault in the ABS. The vehicle's brake system may remain operational without ABS regulation.

If it illuminates during driving along with brake system control indicator (Ⓢ), there is a serious fault in the brake system. Seek the assistance of a workshop immediately, to have the system checked.

Further information ⇨ 9-9.

Ⓢ! Power steering

Will illuminate in yellow when ignition is switched on. Extinguishes after engine is started.

If it does not illuminate when the ignition is switched on, stays lit or illuminates during driving, there is a fault in the system. Seek the assistance of a workshop as soon as possible.

TCSS OFF Traction Control Support System off *

Will illuminate briefly in yellow when the ignition is switched on.

When the TCSS OFF switch (located on the lower instrument panel) is pressed, the control indicator illuminates. The traction control aspect of the Electronic Stability Program (ESP®) is switched off.

With ESP® active, if wheels are slipping on wet, snowy or icy roads, the traction control aspect of ESP® may switch off automatically and the control indicator will illuminate. It will extinguish automatically when prevailing road conditions improve.

Further information ⇨ 9-11.

Ⓢ Electronic Stability Program (ESP®) active *

Will illuminate briefly in yellow when the ignition is switched on.

If it stays lit or illuminates during driving, there may be a fault with ESP®. Seek the assistance of a workshop.

If it flashes 5 times per second when the engine is running, the system has come into action. The engine output may be reduced (the sound of the engine changes) and the vehicle may be braked automatically to a small degree.

If it remains illuminated whilst driving, there may be a fault with ESP®. The vehicle's brake system remains operational without ESP® regulation. Seek the assistance of a workshop to have the cause of the fault remedied.

If the vehicle's battery has been disconnected and reconnected, ESP® is deactivated and the control indicator flashes once per second. Reactivate ESP® by driving in a straight line at over 15 km/h (9 mph) for a few seconds until flashing ceases.

Further information ⇨ 9-10.

ESP Electronic Stability Program (ESP®) fault *

Will illuminate briefly in yellow when the ignition is switched on.

If it stays lit or illuminates during driving, there is a fault with ESP®. The vehicle's brake system remains operational without ESP® regulation. Seek the assistance of a workshop to have the cause of the fault remedied. Further information ⇨ 9-10.

Engine coolant temperature

Will illuminate briefly in red when ignition is switched on.

If it illuminates or flashes when the engine is running: stop vehicle and switch off engine. Coolant temperature is too high; danger of engine damage. Check coolant level.

Warning

Allow engine to cool down before removing coolant filler cap.

Further information ⇨ 10-4.

Preheating for diesel engines *

Will illuminate during engine preheating.

Preheating system switches on only if outside temperature is low.

If it illuminates during driving or if the engine cannot be started, seek the assistance of a workshop as soon as possible.

Starting the engine ⇨ 9-2.

Exhaust emissions

Will illuminate in yellow when ignition is switched on. Extinguishes after engine is started.

If it illuminates when the engine is running: fault in emission control system. The permitted emission limits may be exceeded. Fuel economy and vehicle driveability may be impaired. Seek the assistance of a workshop immediately.

Diesel engines: The engine stops and control indicator  illuminates if the fuel level is too low. If the tank has been run dry, bleed the fuel system ⇨ 10-7.

Vehicles with electric throttle body system *: If the battery has been disconnected, the system must be recalibrated upon reconnection of the battery. Hold ignition key in ON position for 5 seconds without running the engine. Control indicator  remains illuminated after the engine is started if the procedure is not successful.

Engine oil pressure

Will illuminate in red when ignition is switched on. Extinguishes after engine is started.

If it illuminates during driving; engine oil pressure may be dangerously low, interrupting engine lubrication and resulting in damage to the engine and/or locking of the drive wheels:

- Move out of the flow of traffic as quickly as possible without impeding other vehicles,

5-12 Instruments and controls

- Depress clutch,
- Move gearshift lever to neutral (automatic transmission * to N),
- Switch off ignition.

Warning

When the engine is off, considerably greater force will be required for braking and steering.

Do not remove key until vehicle has come to a standstill, otherwise the steering column lock could engage unexpectedly.

Check engine oil level. If the oil level is low, top up using the specified engine oil ⇨ 10-3, 11-6, 12-3.

If the oil level is normal, seek the assistance of a workshop to have the vehicle's lubricating system checked.

Engine oil life monitor *



For engines with diesel particle filter. Will flash in red when engine oil and filter require changing.

Engine oil life monitor * ⇨ 5-14.

● Theft-deterrent

Will start flashing slowly in red after the key is turned to positions LOCK or ACC, or removed from the ignition switch.

Immobiliser

Control indicator  (or  for diesel engines) illuminates when the ignition is switched on, and extinguishes when the engine is started.

If either control indicator flashes after the ignition is switched on, there may be a fault in the immobiliser system; the engine cannot be started ⇨ 2-7.

Front fog lamps *

Control indicator in button , located on the lower instrument panel, illuminates when front fog lamps are switched on ⇨ 6-3.

Rear fog lamp

Will illuminate in yellow when the rear fog lamp is switched on ⇨ 6-3.

High beam

Will illuminate in blue when the high beam is on and when headlamp flash is operated ⇨ 6-2.

Headlamp range adjustment *

Will illuminate during driving to indicate a fault that requires immediate attention. Seek the assistance of a workshop as soon as possible.

Further information ⇨ 6-1.

Door ajar *

Will illuminate in red when a door or the tailgate is open.

Service vehicle soon (for diesel engines) *

Will illuminate briefly in yellow when ignition is switched on.

If it flashes when the ignition is switched on, there may be a fault in the immobiliser system; the engine cannot be started (⇨ “ Immobiliser“, ⇨ 2-7).

If it illuminates when the engine is running; there may be a fault in the engine electronics: interrupt your journey and seek the assistance of a workshop.

If regeneration of the diesel particle filter is not successful or possible (↪ 5-13 “ Diesel particle filter *”), the control indicator may illuminate and the vehicle goes into limp home mode: interrupt your journey and seek the assistance of a workshop immediately.



Further information ↪ 9-7.

Low fuel

If it illuminates during driving; fuel level is low: fill up fuel tank as soon as possible.

Never let the tank run dry!

Erratic fuel supply can cause catalytic converter to overheat ↪ 9-8.

Diesel engines: The engine stops and control indicator  illuminates if the fuel level is too low (↪ 5-11 “ Exhaust emissions”). If the tank has been run dry, bleed the fuel system ↪ 10-7.



Refuelling ↪ 9-12, fuel tank capacity ↪ 12-5.

Diesel particle filter *

Will illuminate briefly in yellow when the ignition is switched on.

If it illuminates during driving, the diesel particle filter requires cleaning.

As soon as the road and traffic situation permits it, increase speed to more than 75 km/h (50 mph) for approx. 30 minutes. The control indicator extinguishes as soon as cleaning is complete.

If regeneration of the diesel particle filter is not successful or possible (↪ 5-12 “ Service vehicle soon *”), control indicator  may illuminate and the vehicle goes into limp home mode: interrupt your journey and seek the assistance of a workshop immediately.

Further information ↪ 9-7.

Turn signal lamps

The appropriate control indicator will flash in green when the turn signal is on.

Rapid flash; failure of a turn signal bulb or the corresponding fuse.

Both control indicators flash when the hazard warning lamps are active.

Turn signal lamps ↪ 6-2, bulb replacement ↪ 10-7, fuses ↪ 10-11.

Warning chimes

While driving:

- when operating the turn signals.
- if driver's seat belt is not engaged and vehicle speed exceeds approx. 15 km/h (9 mph).

When the vehicle is parked and driver's door is opened:

- with exterior lamps switched on (and ignition key removed).
- when the key is in the ignition switch.

Seat belt warning chime ↪ 3-7.

Driving hints ↪ 9-1.

Service interval display *



In the case of vehicles with fixed engine oil change and service intervals, **InSP** appears in the odometer display if the ignition is switched on when servicing is overdue: have the next service carried out within one week or 500 km (300 miles). Seek the assistance of a workshop.

After the service is complete, have the display reset by a workshop.

Engine oil life monitor *



Indicates when the engine oil and oil filter require changing. Based on driving conditions, the interval at which an oil change will be indicated can vary considerably.

When the system has calculated that oil life has been diminished, control indicator  flashes in the instrument cluster when the engine is running. Engine oil and oil filter need changing immediately.

Engine power may be decreased. For the system to work properly, it must be reset every time the engine oil and oil filter are changed: seek the assistance of a workshop.

Trip computer *

The trip computer provides information on driving data, which is continually recorded and evaluated electronically.

To access trip computer vehicle data: With the ignition switched on, press the **MODE** button repeatedly  5-6 until instantaneous fuel consumption, average fuel consumption (**AVG.**) or fuel range (**RANGE**) appears in the odometer display.

Instantaneous consumption



Display of instantaneous fuel consumption.

Until the vehicle is moving, “---” appears in the display.

Average consumption



Display of average fuel consumption. The measurement can be restarted at any time.

To reset: With average consumption showing in the display, press and hold the **MODE** button for approx. 2 seconds. The display will show “---” briefly and the average consumption figure will update after a delay.

Range



Range is calculated from current fuel tank content and instantaneous consumption. The display shows average values.

The range is updated automatically after a brief delay when the vehicle has been refuelled.

When the vehicle is being driven, “---” appears in the display when fuel level is low: fill up fuel tank as soon as possible.

5-16 Instruments and controls

If control indicator  illuminates in the instrument cluster, refuel immediately, regardless of the value shown in the range display.

Setting units of measure

You can select which units of measure are to be used for fuel consumption figures.

With the vehicle stationary and with instantaneous consumption showing in the display, press and hold the **MODE** button for approx. 2 seconds to toggle between **L/100km** and **km/L**.

Interruption of power supply

If the power supply has been interrupted or if the battery voltage has dropped too low, the values stored in the trip computer will be lost.

Lighting

Exterior lighting 6-1
 Interior lighting 6-4



Exterior lighting



Exterior lamps controls



S 17391

Rotate end of lever:

-  = Dipped beam or high beam
-  = Parking lamps
- OFF = Off

In positions  and , the tail lamps, license plate lamps and instrument panel lamps are also on.

Headlamp range adjustment



S 14975

Correct adjustment reduces dazzle for other road users.

With dipped beam on, adjust headlamp range to suit vehicle load:

- Driver only = 0
- Front seats occupied = 0
- All seats occupied = 1
- All seats occupied and load = 2¹⁾ in luggage compartment

6-2 Lighting

- Driver only and load in luggage compartment = 2

1) Vehicles with automatic transmission and all diesel engines: set to position 1.

Hazard warning lamps



To operate, press button .

Turn signal lamps



To activate, move lever up or down:

Lever up = Right turn

Lever down = Left turn

When the steering wheel is turned back, the lever automatically returns to its rest position. This will not happen when making a minor steering manoeuvre such as lane changing.

Tap signal: briefly move lever to resistance point. The turn signal then flashes three times when changing lanes.

Headlamp high beam



To switch from dipped beam to high beam, push lever forwards.

To switch back to dipped beam, pull lever back towards steering wheel.

Control indicator  illuminates in the instrument cluster when high beam is on.

Headlamp flash

To activate the headlamp flash, pull lever towards steering wheel. High beam is engaged for the duration of activation.

Front fog lamps ☼ *

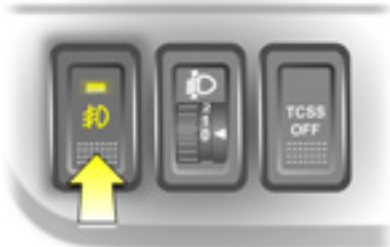

S 14872

The front fog lamps can only be switched on when the ignition is on and the light switch is in position ☼ or ☼ .

- On = Press button ☼ ; control indicator illuminates in button.
- Off = Press button ☼ again; control indicator extinguishes in button.

Follow the regulations of the country in which you are driving when using front fog lamps.

Rear fog lamp ☼



S 17394

The rear fog lamp can only be switched on when the ignition is on and the light switch is in position ☼ .

- On = Turn adjustment band to ☼ ; control indicator ☼ illuminates in instrument cluster.
- Off = Turn adjustment band to OFF; control indicator ☼ extinguishes.

Reversing lamps

Illuminate when reverse gear is engaged and ignition is switched on.

Headlamps when driving abroad

The asymmetrical dipped beam increases the field of vision on the near side of the lane.

When driving in countries which drive on the opposite side of the road, this causes glare for oncoming traffic.

To avoid glare, the headlamp pattern should be adjusted to the horizontal position.

Have the headlamps adjusted by a workshop.

Interior lighting

Courtesy lamps



Move switch position:

- OFF = Interior lamps remain off.
- DOOR = Interior lamps illuminate when a door or the tailgate is opened.
- ON = Interior lamps remain on.

In the DOOR position, front interior lamps and the luggage compartment lamp function as courtesy lamps and illuminate when the doors or tailgate are opened. If doors or tailgate remain opened, lamps remain illuminated for approx. 15 minutes.

Once all doors and the tailgate are closed, the courtesy lamps dim gradually after approx. 15 seconds.

Lamps dim immediately when key is inserted in ignition.

When key is removed from ignition, courtesy lamps illuminate for approx. 15 seconds before dimming gradually.

Depending on equipment version, opening certain doors may not cause courtesy lamps to illuminate, even while the switch is in the DOOR position. Doors which cause courtesy lamps to illuminate are identified by a switch in the door opening *.

The tailgate always causes courtesy lamps to illuminate when the interior lamp switch is in the DOOR position.

Caution

To prevent the battery from becoming discharged, do not leave the interior lamp switch in the ON position when leaving the vehicle.

Luggage compartment lamp



Illuminates when a door or the tailgate is opened.

Infotainment system

Steering wheel mounted remote control 3..... 7-2

Theft-deterrent feature 7-3

Operation 7-4

Sound settings 7-5

Radio 7-6







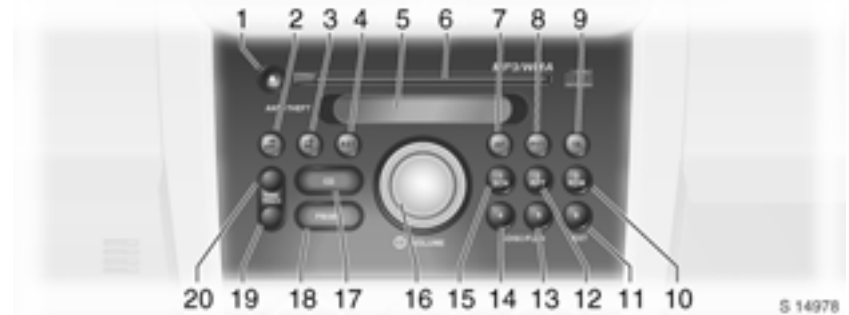

Audio players 7-9

Mobile telephones and radio equipment (CB) 3 7-10

Introduction

Overview



- ❶  Ejection of CDs
- ❷  Sound settings
- ❸  Mute/unmute
- ❹  AST
- ❺  Display panel
- ❻  Slot for audio/MP3 CDs
- ❼  AF
- ❽  Program Type

7-2 Infotainment system

- | | | |
|----|---------------|---|
| 9 | TA | Traffic Announcement |
| 10 | 3, RDM | Radio: Preset station 3,
CD/MP3: Random playback |
| 11 | 6, TEXT | Radio: Preset station 6,
MP3: Text display |
| 12 | 2, RPT | Radio: Preset station 2,
CD/MP3: Repeat track |
| 13 | 5, DISC/FLD + | Radio: Preset station 5,
MP3: Skip to next folder |
| 14 | 4, - DISC/FLD | Radio: Preset station 4,
MP3: Skip to previous folder |
| 15 | 1, SCN | Radio: Preset station 1,
CD: Scan tracks |
| 16 | ⓪ VOLUME | Press: Switching on and off,
Turn: Volume setting |
| 17 | CD | CD player mode |
| 18 | FM/AM | Switch between FM and AM wavebands |
| 19 | ∇ | Radio: Search downwards,
CD: Skip backwards,
MP3: Skip to previous file |
| 20 | ∧ | Radio: Search upwards,
CD: Skip forwards,
MP3: Skip to next file |

Steering wheel mounted remote control *



Infotainment system functions can be operated with the buttons mounted on the steering wheel.

To change the volume:
Press the + or - button.

To mute the Infotainment system:
Press the M button.

To change the mode:
Press the MODE button.

Pressing the MODE button also switches the Infotainment system on.

To search for the next or previous radio station:

Press and hold the \wedge button (higher frequency) or \vee button (lower frequency).

To select the next or previous preset station:

Briefly press the \wedge button (next stored station) or \vee button (previous stored station).

With CD mode active, to select the next or previous track:

Press the \wedge button (next track) or \vee button (previous track).

Thft-deterrent feature

The Infotainment system is fitted with an electronic security system for anti-theft protection, ensuring the system is useless to a thief.

You can set up a 4-digit security ID to prevent theft. Once the ID is set up, the unit is inoperable without this ID when the unit is removed or the battery is disconnected.

The Infotainment system is programmed with the default code '0000' in the as-delivered state.

Setting 4-digit security ID

To set a user ID, proceed as follows:

1. Briefly press the $\textcircled{1}$ VOLUME rotary knob $\textcircled{16}$ to switch the Infotainment system off.
2. Press and hold the numbered button 3 $\textcircled{10}$ and button 4 $\textcircled{14}$ simultaneously and press the $\textcircled{1}$ VOLUME rotary knob $\textcircled{16}$. "SEC" appears in the display.
3. Press the \wedge button $\textcircled{20}$ and numbered button 1 $\textcircled{15}$ simultaneously.
"- - - -" appears in the display.

4. Press numbered button 1 $\textcircled{15}$ repeatedly to increase the value for the first user ID digit.
Likewise, numbered buttons 2 $\textcircled{12}$, 3 $\textcircled{10}$ and 4 $\textcircled{14}$ correspond to the second, third and fourth digits of the user ID. Set each user ID digit by pressing the corresponding numbered button repeatedly until your chosen user ID is complete.
5. Press and hold the PTY button $\textcircled{8}$ for approx. 2 seconds to enter your chosen user ID.
"SEC" appears again in the display and the Infotainment system is switched off automatically.
The user ID is now required when the Infotainment system is switched on after the unit has been removed or the battery has been disconnected.

Entering 4-digit security ID

When the Infotainment system is switched on after the unit has been removed or the battery has been disconnected, the 4-digit security ID must be entered, otherwise the unit is inoperable.

“SEC” appears in the display when the system is switched on. This will not happen if the system is switched off and back on again within 20 seconds.

To enter the user ID, proceed as follows:

1. Press the \wedge button **20** and numbered button 1 **15** simultaneously.
“ - - - - ” appears in the display.
2. Repeatedly press numbered buttons 1 **15**, 2 **12**, 3 **10** and 4 **14** which correspond to the digits of the user ID, until the correct stored user ID is displayed.

3. Press and hold the PTY button **8** for approx. 2 seconds to enter the correct stored user ID.

The Infotainment system is switched off automatically.

Switch the Infotainment system back on to operate: the system comes on in radio mode.

If the wrong user ID is entered 10 times, “HELP” appears in the display and the system cannot be operated. Seek the assistance of a workshop.

If you forget your user ID, seek the assistance of a workshop.

Deleting 4-digit security ID

The stored user ID can be erased and a new ID set at any time.

To delete the existing user ID, repeat steps 1 to 3 in “Setting 4-digit security ID” then proceed as follows:

1. Repeatedly press numbered buttons 1 **15**, 2 **12**, 3 **10** and 4 **14** which correspond to the digits of the user ID, until the correct stored user ID is displayed.
2. Press and hold the PTY button **8** for approx. 2 seconds to enter the correct stored user ID.
“ - - - - ” appears in the display and the Infotainment system is switched off automatically.

Set a new user ID as described in “Setting 4-digit security ID”.

Operation

Switching on and off

Briefly press the \odot VOLUME rotary knob **16**.

Setting the volume

Turn the \odot VOLUME rotary knob **16**.

Mute function

Press the  button **3**.

In CD mode, playback is paused instead of muting.

Cancelling the mute function

Press the  button **3** again.

- or -

Press any other button.

- or -

Switch off the Infotainment system.

The mute function is deactivated the next time the system is switched on.

Sound settings

Set the volume using “Treble” and “Bass” or “AVC” (Auto Volume Control).

You can also set the volume distribution using “Fader” and “Balance”.

Press the  button **2** to enter the sound settings menu.

Sound settings appear in the following order when the  button **2** is pressed repeatedly:

- BAS (Bass),
- TRE (Treble),

■ BAL (Balance),



■ FAD (Fader),



■ AVC (Auto volume control) *.



The AVC function is only available in the version with MP3 player *.



Cycle through the sound settings and press the  button **2** again to exit the sound settings menu.

Adjusting sound settings

With relevant sound setting showing in the display, press the  button **20** or  button **19**.

In the “Treble” and “Bass” modes, pressing the  button **20** increases the treble/bass, and pressing the  button **19** decreases the treble/bass.

In “Fader” mode, pressing the  button **20** decreases rear speaker volume, and pressing the  button **19** decreases front speaker volume.

In “Balance” mode, pressing the  button **20** decreases left speaker volume, and pressing the  button **19** decreases right speaker volume.

In “AVC” mode, pressing the  button **20** repeatedly cycles through the following Auto Volume Control settings:

■ ‘AVC OFF’,

■ ‘AVC1’,

■ ‘AVC2’



■ ‘AVC3’.

Pressing the  button **19** repeatedly cycles through the Auto Volume Control settings in reverse order.

AVC (Auto Volume Control) *

The AVC function automatically adjusts the volume in accordance with vehicle speed, to compensate for outside and road noises.

AVC is provided with 3 selectable levels of sensitivity (‘AVC1’, ‘AVC2’ and ‘AVC3’) and can also be switched off altogether (‘AVC OFF’). Selecting ‘AVC3’ increases the range of volume adjustment to the maximum level.

In the “AVC” sound setting mode (see “Adjusting sound settings” section above), press the  button **20** or  button **19** to adjust setting.

Radio

Radio reception *

Vehicle radio reception will differ from that obtained with domestic radios.

As the vehicle antenna is relatively near the ground, the broadcasting companies cannot guarantee the same quality of reception as is obtained with a domestic radio using an overhead antenna.

- Changes in distance from the transmitter
 - multi-path reception due to reflection and
 - shadowing
- may cause hissing, noise, distortion or loss of reception altogether.

AM-FM radio

The Infotainment system provides the following wavebands:

AM (Long Wave and Medium Wave) and FM (Frequency Modulation).

In addition, a manual storing and automatic storing facility is available on each of the wavebands, where

stations can be manually or automatically stored and recalled using the preset stations buttons 1-6.

Radio mode

To enter radio mode when the Infotainment system is switched-off or while in any other mode, press the FM/AM button **18**. The last station selected is received.

Wavebands appear in the following order when the FM/AM button **18** is pressed repeatedly:

- FM1,
- FM2,
- LW,
- MW1,
- MW2.

Automatic search

To search for the next or previous radio station, press and hold the **^** button **20** (higher frequency) or **v** button **19** (lower frequency) for approx. 1 second and release.

The Infotainment system will tune to the next receivable radio station on the selected waveband.

If 'AF' has been switched on previously, the unit only searches for RDS stations.

Station memory

In each waveband, 6 stations can be stored under preset station memory locations 1-6.

To store stations manually

Tune to the desired waveband and station. Press and hold the preset station button (1-6) for approx. 2 seconds where the selected station is to be stored. Previously stored stations are overwritten.

To store stations automatically

Tune to the desired waveband. Press and hold the AST button **4** for approx. 2 seconds. 6 stations with strong signals are automatically stored under preset station memory locations 1-6. Previously stored stations are overwritten.

If 'AF' has been switched on previously, the unit only searches for RDS stations.

If less than 6 stations with strong signals can be received, the number of preset stations may be less than 6. If no stations with strong signals can be received, previously stored stations are reset.

When automatic storing is complete, the radio station stored under preset station memory location 1 is received.

To exit automatic storing while storing is in progress, press the AST button **4** again. Previously stored stations are not overwritten.

Recalling stored stations

To recall a station stored under one of the preset station memory locations 1-6, tune to the desired waveband and press the relevant preset station button (1-6). The station corresponding to the preset station button is received.

If a station is not stored on the selected preset station button (1-6), "--" will appear in the display.

RDS (Radio Data System)

RDS is a European service provided by broadcasting companies, which makes finding the required FM station much easier and aids good reception.

RDS stations transmit information which is automatically evaluated by the RDS radio.

In some areas, other functions associated with RDS are available, e.g. TA (Traffic Announcement) and REG (Regionalisation).

AF (Alternative Frequency)

An RDS program is transmitted on several frequencies simultaneously.

With AF on, during the journey the Infotainment system automatically searches for the strongest receivable frequency.

REG (Regionalisation)

Some RDS stations transmit different regional programs over different frequencies at certain times.

With REG on, when searching for the frequency of a radio program with the strongest reception using AF

(Alternative Frequency), the Infotainment system always remains tuned to the selected regional program.

With REG off, when searching for the frequency of a radio program with the strongest reception using AF (Alternative Frequency), the Infotainment system does not consider regional programs.

Switching AF and REG on and off

Settings appears in the following order when the AF button **7** is pressed repeatedly:

- AF on/REG off,
- AF on/REG on,
- AF off, REG off.

With AF and/or REG active, "AF" and "REG" appear in the display respectively.

PTY (Program Type)

Many RDS stations transmit a PTY code that indicates the type of program being broadcast

(e.g. News). The PTY code enables selection of the station according to program type.

Searching for stations by program type

Press the PTY button **8** to select PTY mode.

Turn the **Ⓛ** VOLUME rotary knob **16** to select the desired PTY (e.g. News, Sports).

Press the **∧** button **20** or **∨** button **19** to begin search within the selected PTY.

If no station within the selected PTY code is received, "NOTHING" appears in the display followed by "PTY". Select another PTY as described above.

TA (Traffic Announcement)

Traffic stations are RDS stations which transmit traffic information.

With TA on, the Infotainment system searches for stations emitting TP (Traffic Programs) and tunes into such stations in preference to others.

When TA is active and a Traffic Program is currently being received, CD/MP3 CD ***** playback is interrupted for the traffic announcement and is resumed when the announcement ends.

Switching TA on and off

Press the TA button **9** to switch on traffic announcements.

With TA active, "TA" appears in the display. When a Traffic Program is currently being received, "TP" also appears in the display.

Press the TA button **9** again to switch off traffic announcements.

To search for a TP station (TP SEEK) while TA is active, press the **∧** button **20** or **∨** button **19**.

If TP data is not received within approx. 20 seconds after TA is switched on, TP SEEK automatically takes place only once.

If no TP station is received, "NOTHING" appears in the display.

PS (Program Service Name)

Display of program name instead of station frequency.

EON (Enhanced Other Networks)

With EON, you will hear traffic reports, even if the set station does not transmit its own traffic information. When a traffic announcement is made, the unit switches to a traffic information station linked to EON.

When EON is active, "EON" appears in the display.

Audio players

Single CD player

The Infotainment system is equipped with a CD player that can play audio CDs and, if equipped, MP3 CDs ✱. The CD player will automatically recognise the CD type.

Do not, under any circumstances, insert DVDs, single CDs with a diameter of 8 cm and CDs with irregular shapes into the CD player. These discs may become jammed in the CD player or destroy the drive mechanism, invalidating the unit's warranty.

The system may not be able to play CD-Rs or play these items properly, depending on their nature.

CD-RW discs cannot be played back on the Infotainment system.

CD/MP3 ✱ playback

To enter CD mode when the Infotainment system is switched-off or while in any other mode, press the CD button **17** if a CD is already inserted in the audio/MP3 CD slot.

If a CD is not already inserted, place an audio CD into the CD slot with the printed side facing upwards, just sufficiently for it to be automatically retracted. CD playback begins and "CD IN" appears in the display.

Do not apply force when inserting CDs into the slot.

Selecting next or previous track

Press the **^** button **20** to skip to the next track.

Press the **v** button **19** once to skip back to the start of the current track or press it twice to skip back to the previous track.

Fast forwards/backwards search

Press and hold the **^** button **20** to fast forward through the current track.

Press and hold the **v** button **19** to fast rewind through the current track.

During fast forward/rewind, the track is played at a higher speed.

If 'REPEAT' has been switched on previously and the end of the repeated track is reached during fast

forward/rewind, the repeat function is disabled and normal playback will be resumed.

While fast forwarding, if the end of the disc is reached, the disc returns to the first track.

Random play

Press the RDM button **10** to play the tracks on the disc in random order. "RDM" appears in the display.

Switch off random play by pressing the RDM button **10** again.

Repeat play

Press the RPT button **12** to play the current track repeatedly. "RPT" appears in the display.

Switch off repeat play by pressing the RPT button **12** again.

Scan CD

Press the SCN button **15** to play the first few seconds of each track on the disc. "SCN" appears in the display.

Switch off the scan CD function by pressing the SCN button **15** again.

Selecting next or previous MP3 folder *

If the MP3 CD consists of several folders, the required folder can be selected as follows:

Press the DISC/FLD + button **13** to skip to the next folder.

Press the - DISC/FLD button **14** to skip back to the previous folder.

Displaying MP3 text

MP3 text types appear in the following order when the TEXT button **11** is pressed repeatedly:

- Elapsed time,
- Folder name,
- File name.

Press and hold the TEXT button **11** for approx. 2 seconds to enable scrolling text.

Removing CDs

Press the **▲** button **1**.

The CD is ejected.

Maintenance and care

- Never insert foreign objects in the CD slot.
- If “ERROR 1” appears in the display, the disc cannot be read. If a normal, undamaged disc is inserted and the message remains, seek the assistance of a workshop.
- If “ERROR 3” appears in the display, the player has developed an unidentified error. The inserted disc may not eject. Seek the assistance of a workshop.
- Do not use commercially available CD protection sheets or discs equipped with stabilisers, as they may get trapped in the internal mechanism.
- Do not use any abrasive chemicals, cleaning solutions or strong cleaners. Use only a soft cloth moistened with soapy water.
- The system must only be serviced by trained specialists. Faulty installation or servicing may invalidate the unit's warranty.

Mobile telephones and radio equipment (CB) *

Installation and operation

The Opel installation instructions and the operating guidelines provided by the telephone manufacturer must be observed when fitting and operating a mobile telephone.

Failure to do so could invalidate the vehicle's operating permit (EU Directive 95/54/EG).

Requirements to ensure trouble-free operation:

- Professionally installed exterior antenna, to obtain the maximum range possible
- Maximum transmission power 10 Watts.
- Installation of the telephone in a suitable spot (front centre console).

Obtain advice on predetermined installation locations for the external antenna and equipment holder and ways of using devices with transmission power of more than 10 Watts.

Operation of a handsfree attachment with no outside antenna, using the mobile telephone standards GSM 900/1800/1900 and UMTS, may take place only if the maximum transmission power of the mobile telephone does not exceed 2 Watts, in the case of GSM 900, and otherwise 1 Watt.

For safety reasons, we recommend that you do not use the phone while driving. Even use of a handsfree set can be a distraction while driving. Observe any country-specific regulations.

When used in the vehicle interior, mobile telephones and radio equipment (CB) with integrated antenna may cause malfunctions in the vehicle electronics.

 **Warning**

Mobile telephones and radio equipment (CB) should only be used with an antenna fitted on the vehicle exterior.

Climate controls

Heating and ventilation controls.....	8-1
Air vents	8-4
Heated rear window, heated exterior mirrors 3	8-5
Air intake	8-6
Pollen filter.....	8-6

Climate control system



S 14960

Ventilation, heating and cooling * are combined into one unit that is designed to provide comfort regardless of the season, weather or outside temperature.

Button for cooling ❄ (or A/C) is only present in version with air conditioning system *.

Heating and ventilation controls

Temperature



S 14965

To red = Warm
To blue = Cold

Air flow



S 14986

Four fan speeds:

- ☒ = Off
- 4 = Maximum air flow

The rate of air flow is determined by the fan. The fan should therefore be switched on during driving.

Air distribution



S 14984

- ☒ = To head area via centre and side air vents
- ☒☒ = To head area via centre and side air vents and to footwell
- ☒☒☒ = To footwell
- ☒☒☒☒ = To windscreen, front door windows, side air vents and to footwell
- ☒☒☒☒☒ = To windscreen, front door windows and side air vents

Window demisting and defrosting

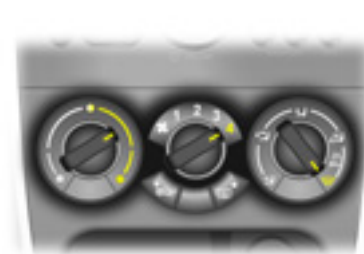



S 14989

To clear misted or icy windows, e.g. due to damp weather, damp clothing or low outside temperatures:

- Turn air recirculation mode ☒☒ off.
- Set air distribution rotary knob to ☒☒☒☒.
- Turn temperature rotary knob to red area for warm air.
- Set fan to 4.
- Open adjustable side air vents and direct them towards door windows.
- Switch on heated rear window ☒☒☒☒.

8-3 Climate controls

For simultaneous warming of the footwell, set air distribution rotary knob to .

Switch on air conditioning * to improve defrosting efficiency when position  or  is selected.

Air recirculation mode *



S 14990

During 'normal' operation, the heating, ventilation and air conditioning system * uses outside air. To prevent fumes or unpleasant odours from entering the vehicle when in stationary traffic and when rapid heating or cooling of the passenger compartment is required,

press button ; control indicator in the button illuminates and air is recirculated.

⚠ Warning

Air recirculation mode should only be used for brief periods, due to gradual deterioration in air quality and an increase in humidity, causing windows to mist up. Driving with air recirculation mode on for extended periods may cause vehicle occupants to feel drowsy.

Press button  again to turn air recirculation mode off; control indicator in the button extinguishes and outside air is drawn into the vehicle.

Air conditioning system *

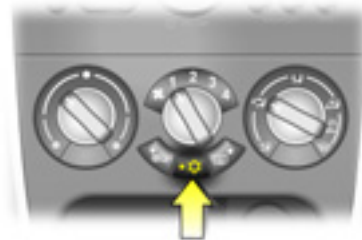

S 14991

Operational only with engine running and with the fan switched on:

- Press button  (or A/C) = On
- Press button again = Off

Control indicator in the button illuminates when air conditioning is enabled and extinguishes when the system is switched off.

Cooling switches off automatically at low outside temperatures.

Switch off cooling when not required, in order to save fuel.

Even with air conditioning on, if temperature rotary knob is set to warm, the vehicle will still produce warm air in the passenger compartment.

To improve efficiency of the air conditioning, always close the windows, to prevent chilled air from escaping.

In very high temperatures, before starting the engine, allow hot air to escape from the vehicle by opening the windows and switching on the fan.

When the air conditioning system is switched on, open adjustable side air vents so that the evaporator does not ice up due to lack of air movement.

When cooling (air conditioning compressor) is switched on, condensation forms, which is expelled from the underside of the vehicle.

To ensure continuously efficient performance and prolong the life of the air conditioning system, it must be



switched on for a few minutes once a week, irrespective of the weather and time of year.

Malfunctions in the system must not be rectified by the owner: seek the assistance of a workshop.

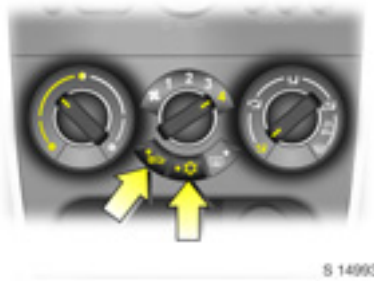
Maximum cooling



Open windows briefly and switch fan on so that warm air can escape rapidly.

- Press button  (or A/C) (to switch on air conditioning system).
- Activate air recirculation mode .

- Set air distribution rotary knob to .
- Turn temperature rotary knob all the way to blue area for cooling.
- Set fan to 4.

Air vents

Centre air vents





The air flow can be directed as desired by tilting the slats up, down and sideways using the central adjuster.

The air supply is increased by switching on the fan.

Side air vents



To open and close side air vents, turn horizontal knurled wheel to the left or right.



Open side air vents when air distribution rotary knob is set to position  or .

The air flow can be directed up and down by tilting the slats up and down using the central adjuster. Air flow is directed sideways by turning the horizontal knurled wheel to the left or right.

Depending upon the position of the temperature rotary knob, cold or heated air will be directed into the vehicle via these air vents.

The air supply is increased by switching on the fan.

Door window defroster vents

Air distribution rotary knob set to  or ; cooled or heated air will be directed onto the windscreen and onto the door windows (mainly in the area of the exterior mirrors).

Heated rear window, heated exterior mirrors *

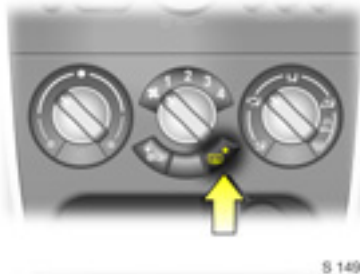

Operational only with engine running.

Press button  = On

Press button  again = Off

Control indicator in the button illuminates when heating is operational and extinguishes when heating is switched off.

Turn off heating as soon as vision is clear.

Rear window and exterior mirror heating is switched off automatically after approx. 15 minutes.

To avoid discharging the battery, do not operate when you are just starting the vehicle, or if there is a build up of snow or ice.

Do not use sharp instruments or abrasive cleaners on rear window or exterior mirrors, and avoid scratching or damaging their heating elements.

Maintenance

Air intake

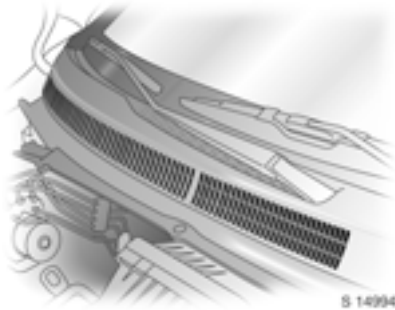

The air intakes in front of the windscreen in the engine compartment must be kept clear to allow air intake. Remove any leaves, dirt or snow.

Pollen filter

The pollen filter cleans dust, soot, pollen and spores from the air entering from outside.

Replace the pollen filter at the intervals given in the chapter “Service and maintenance” ⇨ 11-2.

Driving and operating

Starting the vehicle	9-1
Transmission	9-3
Engine exhaust.....	9-7
Brakes	9-9
Ride control systems	9-10
Fuel	9-12

Starting the vehicle

Driving hints

During the first 1000 km (600 miles), drive your vehicle at various speeds. Do not use full throttle. Never allow the engine to labour at low revs.

Make good use of all gears. Depress the accelerator pedal a maximum of around three quarters of the available pedal travel in all gears and drive ranges.

Do not brake unnecessarily hard for the first 200 km (125 miles).

When the vehicle is driven for the first time, wax and oil on the exhaust system may evaporate, producing smoke-like emissions which should not be inhaled. Allow wax and oil to evaporate while the vehicle is in the open air.

Never coast with engine not running as many units may then not function (e.g. brake servo unit, power steering, airbag system). Driving in this manner is a danger to yourself and others.

Pedals

To ensure the pedal travel is uninhibited, there must be no mats in the area of the pedals.

Ignition positions



S 14891

- | | | |
|-------|---|---|
| LOCK | = | Ignition off |
| ACC | = | Steering unlocked, ignition off |
| ON | = | Ignition on, with diesel engine: preheating |
| START | = | Start (transmission in neutral) |

To release the steering column lock, turn ignition key to position ACC and rotate steering wheel slightly.

Before starting-off, check:

- Tyre pressures and condition.
- Engine oil level and fluid levels in engine compartment ⇨ 10-3.
- All windows, mirrors, exterior lighting and license plates are free from dirt, snow and ice and are operational.
- Objects are securely located and will not be thrown forward in the event of sudden braking.
- Seats, seat belts and mirrors are correctly adjusted.
- All gauges and control indicators.
- Brake operation.

Starting the engine



S 14897

With manual transmission in neutral, depress clutch and foot brake, (automatic transmission * in P or N), do not accelerate.

Petrol engines: Turn key to START and release it.

Diesel engines: Turn key to ON, when preheating control indicator  extinguishes, turn key to START and release it.

Preheating system switches on only if outside temperature is low.

Key returns automatically to ON position when released.

Start attempts should not last longer than 15 seconds. If engine does not start, wait 15 seconds before repeating starting procedure. If necessary, depress accelerator before repeating starting procedure.

Parking the vehicle

- Apply the parking brake firmly without actuating the release button. On a downhill or uphill slope, apply as firmly as possible. Depress foot brake at the same time to reduce operating forces.
- Push key into ignition switch before turning to LOCK position and removing (vehicles with automatic transmission *: depress foot brake and shift into **P**). Turn steering wheel until lock is felt to engage (anti-theft protection).
- If the vehicle is parked on a level surface or a hill, select 1st gear before switching the ignition off, (vehicles with automatic transmission *: shift into **P**). Also turn front wheels away from kerb if parked on an uphill slope.

- If the vehicle is parked on a downhill slope, select reverse gear before switching the ignition off, (vehicles with automatic transmission ✱: shift into **P**). Also turn front wheels towards kerb.
- Switch off exterior lamps, otherwise the headlamp warning device will sound when the driver's door is opened.
- Cooling fans may run on after the engine has been switched off ⇨ 10-1.

Parking over things that burn

Do not park vehicle on easily ignitable surfaces as the hot exhaust system temperatures could cause the surface to ignite.

Transmission

Automatic transmission ✱

The engine can only be started when the selector lever is in position **P** or **N**. When starting in **P** or **N**, depress foot brake before selecting a gear, then release the parking brake.

Do not accelerate whilst gearshifting. If a gear has been selected and the foot brake is released without accelerating, the vehicle will "creep".

Never operate the foot brake and accelerator simultaneously.

Selecting **D** puts the transmission in automatic mode.

- Only select **3**, **2** or **L** to prevent automatic upshifting above the selected gear or as an aid to engine braking.

The selected gear is shown in the transmission display.

Transmission display



Displays the selected mode or current gear.

Selector lever settings

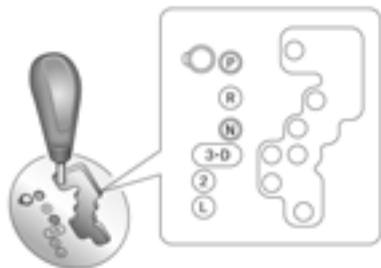

S 14896

- P Park position. Front wheels locked. Only engage when the vehicle is stationary and the parking brake is applied. "P" appears in the transmission display.
- R Reverse gear. Only engage when the vehicle is stationary. "R" appears in the transmission display.
- N Neutral or idle. "N" appears in the transmission display.

- D Drive position for normal driving in 1st gear to 4th gear. "D" appears in the transmission display.
- 3 Transmission shifts automatically up to 3rd gear only. The current gear appears in the transmission display.
- 2 2nd gear only. The current gear appears in the transmission display.
- L 1st gear only. The current gear appears in the transmission display.

Selector lever can only be moved out of **P** or **N** with the ignition switched on and the foot brake depressed.

Never shift to **P** or **R** while the vehicle is moving.

Gears 3, 2, L

The transmission does not shift above the selected gear.

The current gear appears in the transmission display.

Kickdown

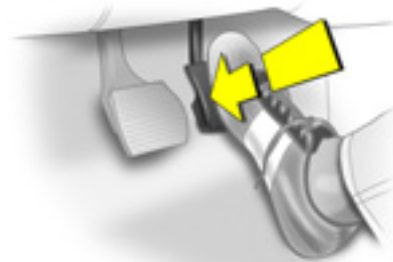

S 15096

Depress accelerator pedal past the pressure point and hold in position; below certain speeds, the transmission shifts down into a lower gear.

Engine braking assistance

In order to utilize the engine braking effect when driving downhill, select drive range **3**, **2** or, if necessary, **L** in good time.

Stopping the vehicle

Engage parking brake and move selector lever to position **P**. It will not be possible to turn the ignition key to the LOCK position unless the selector lever is in position **P**.

Rocking the vehicle

If it becomes necessary to rock the vehicle to free it from water, ice, sand, mud, snow or a dip, observe the following:

Move the selector lever between **R** and a forward gear in a repeat pattern while applying light pressure to the accelerator pedal when the vehicle is in gear.

Do not spin the wheels or race the engine and avoid sudden acceleration.

Manoeuvring the vehicle



To manoeuvre the vehicle back and forth during attempts to park or in garage entrances, the creeping movement can be utilized by releasing the foot brake.

Never actuate the accelerator and brake pedals simultaneously.

Fault



If there is a problem with the automatic transmission, control indicator  flashes. The transmission no longer shifts automatically.

Seek the assistance of a workshop to rectify the cause of the fault.

Interruption of power supply

If the vehicle battery is flat, the selector lever cannot be moved out of position **P**.

Start the vehicle using jump leads  10-26.

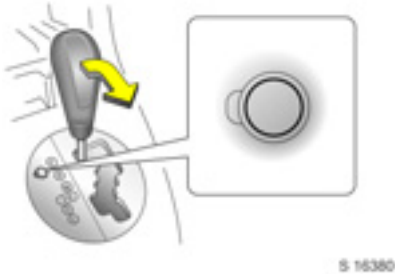

If the battery is not the cause of the fault, release selector lever as follows:

1. Apply the parking brake.
2. Switch off engine then turn key to ignition switch position ACC or ON.
3. Remove cap concealing release button and using a suitable tool, push the button. Then move selector lever.

On variants with SHIFT LOCK button ✱, push button and move selector lever.

This procedure is for emergency use only. If repeated use of this procedure is necessary, or the procedure does not work as described, seek the assistance of a workshop.

Manual transmission



Reverse: with the vehicle stationary, wait 3 seconds after declutching before engaging gear. If the gear does not engage, set the lever in neutral, release the clutch pedal and depress again; then repeat gear selection.

When driving, do not use the clutch pedal as a foot rest; this will cause substantial clutch wear.

Engine exhaust

Diesel particle filter (DPF) *

The diesel particle filter removes polluting soot particles out of the exhaust.

The system contains a self-cleaning function at certain intervals. The filter is cleaned by burning the soot particles at high temperature. This procedure runs automatically under certain vehicle conditions and can take up to 30 minutes, during which time fuel consumption may increase. The smell and the noise that occur are normal.

Self-cleaning may begin automatically during idling; engine speed increases and cooling fan operates automatically.



The system cannot automatically clean itself under certain vehicle conditions, such as driving short distances.

If control indicator  illuminates, you should continue driving, and as soon as the road and traffic situation permits it, increase speed to more than 75 km/h (50 mph) and diesel particle filter cleaning will start.

Cleaning is quicker at faster speeds and under load. The control indicator extinguishes as soon as cleaning is complete.

We recommend that you do not turn the ignition off during cleaning.



If regeneration of the diesel particle filter is not successful or possible, control indicator  may illuminate and the vehicle goes into limp home mode: interrupt your journey and seek the assistance of a workshop immediately.

Catalytic converter

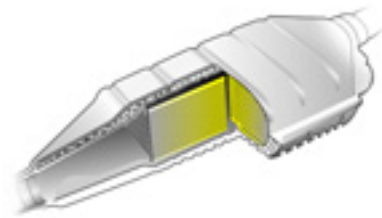

S 15073

Controlling exhaust emission



The catalytic converter reduces to a minimum the proportion of noxious materials in the exhaust, such as carbon monoxide (CO), hydrocarbons (CH) and nitrogen oxides (NO_x).

Leaded fuel will damage the catalytic converter and parts of the electronic system, thereby rendering them inoperative.

Caution

Damage to the catalytic converter or the vehicle may result if the following points are not observed.

- If the engine misfires or runs roughly after a cold start, the engine power has reduced significantly or other unusual operating problems occur that indicate a fault in the ignition system, seek the assistance of a workshop as quickly as possible. Drive at a slower speed and with less engine revs for a short time, if necessary.
- If unburned fuel enters the catalytic converter, this may result in overheating and irreparable damage to the catalytic converter. You should therefore avoid frequent cold starts, unnecessarily long use of the starter when setting off, running the tank dry (an irregular fuel supply leads to overheating) and starting the engine by pushing or towing.

- If the control indicator for exhaust emissions  illuminates whilst driving, seek the assistance of a workshop immediately. Control indicator  for exhaust emissions ⇨ 5-11.

Exhaust gases

Danger

Engine exhaust gases contain poisonous carbon monoxide, which has no colour or odour and can be lethal if inhaled.

If exhaust fumes penetrate the vehicle interior, open the windows and seek the assistance of a workshop immediately.

Brakes

Foot brake

The brake system comprises two separate brake circuits.

If one brake circuit should fail, the vehicle can still be braked with the second remaining circuit.

If this happens, the brake pedal must be fully depressed with greater pedal pressure. The distance required for braking will be greater. Seek the assistance of a workshop.

In order to utilise the full pedal travel, particularly in the event of a brake circuit fault, there must be no mats in the area of the pedals ⇨ 9-1.

With the engine stopped, the brake servo assistance is discontinued after the brake pedal has been depressed once or twice. The braking effect is not reduced, but increased foot pressure will be necessary. Take extra care if the vehicle is being towed.

Brake system control indicator ⇨ 5-9.

Anti-lock Brake System (ABS) ^(ABS)

The ABS prevents the wheels from locking during heavy braking.

It starts to regulate braking pressure as soon as a wheel shows a tendency to lock. The vehicle remains steerable, even during heavy braking, e.g. on bends or when swerving to avoid an obstacle. Even in the case of extreme braking, ABS makes it possible to drive round obstacles without releasing the foot brake.

ABS control indicator ⇨ 5-9.

Fault

Caution
If there is a fault in the ABS, the wheels may lock during heavy braking. This may cause the vehicle to swerve.

Have the cause of the fault remedied by a workshop.

Parking brake

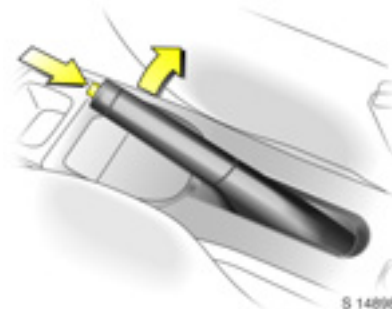

Always apply the parking brake firmly without actuating the release button. Apply as fully as possible on uphill or downhill inclines.

To release the parking brake, press and hold the button, pull the lever up slightly and lower lever while holding the button in.

To reduce the operating forces of the parking brake, depress the foot brake at the same time.

Brake system control indicator ⇨ 5-9.

Brake assist

Rapid powerful application of the brake pedal automatically applies maximum brake force amplification to achieve the shortest possible braking distance under full braking (brake assist).

Maintain steady pressure on the brake pedal for as long as full-on braking is to continue. When the brake pedal is released, the maximum brake force amplification is taken away.

Ride control systems

Electronic Stability Program (ESP®) *

The Electronic Stability Program improves driving stability when necessary, independently of the type of road surface and the tyre grip. It also prevents the drive wheels from spinning.

The system monitors vehicle movements. As soon as the vehicle starts to swerve (understeers/oversteers), engine output is reduced (the sound of the engine changes) and individual wheels are specifically braked. This considerably improves the driving stability of the vehicle on snow and ice and on wet or slippery road surfaces.

ESP® is ready for operation as soon as the ignition is switched on and the control indicators , ESP and TCSS OFF extinguish.

When the ESP® comes into action, control indicator  flashes rapidly in the instrument cluster. Some noise or vibration may be apparent.

Caution

Do not let this special safety feature tempt you into taking risks when driving.

Traffic safety can only be achieved by adopting a responsible driving style.

ESP active control indicator  5-10.

Interruption of power supply

If the vehicle's battery has been disconnected and reconnected, ESP® is deactivated and control indicator  flashes once per second.

Reactivate ESP® by driving in a straight line at over 15 km/h (9 mph) for a few seconds until flashing ceases. Several seconds may lapse before the control indicator extinguishes, depending on road conditions.

9-11 Driving and operating

Fault

Control indicator **ESP** illuminates during driving if there is a fault with **ESP**[®]. Seek the assistance of a workshop to have the cause of the fault remedied.

ESP fault control indicator ⇨ 5-10.

Traction Control Support System (TCSS) *

TCSS is a component part of the Electronic Stability Program (**ESP**[®]) which helps to maintain driving stability and prevents the drive wheels from spinning.

Switching off



With **ESP**[®] active, if wheels are stuck in mud, sand or snow, TCSS can be switched off when spinning of the wheels is necessary.

Press button **TCSS OFF**; control indicator **TCSS OFF** illuminates in the instrument cluster.

Switch TCSS on when normal driving is resumed, by pressing button **TCSS OFF** again. All **ESP**[®] systems are reactivated.

Control indicator **TCSS OFF** illuminates briefly in the instrument cluster when the ignition is switched on and may also illuminate during driving depending on road surface.

TCSS off control indicator ⇨ 5-10.

Fuel

Petrol engine fuel

Use only unleaded fuels meeting the specifications of DIN EN 228.

Refuel using the correct octane number ↷ 12-3.

If the RON 95 label is attached to the tank flap, unleaded fuel with an octane rating of 95 or higher must be used.

Caution
A fuel of too low an octane can lead to engine damage.

Diesel engine fuel

Use only diesel engine fuel meeting the specifications of DIN EN 590.

Marine diesel fuel, fuel oils, diesel fuels, which are entirely or partially plant based such as rape seed oil or bio-diesel, Aquazole and similar diesel-water emulsions must not be used.

The flow and filterability of diesel fuels are temperature-dependent.

Fuel filler cap

If replacing the fuel filler cap, be sure to use the original fuel filler cap for your model, to ensure full functionality.

Refuelling

Warning

Before refuelling, switch off the engine and any heating systems with combustion chambers.

Switch off mobile phones.

Fuel is inflammable and explosive, therefore avoid dealing with fuel near naked flames and doing anything that would generate sparks. No smoking!

This also applies where the smell of fuel is noticeable. If the smell of fuel vapour occurs in the vehicle itself, have the cause remedied immediately by a workshop.

Observe the operating and safety instructions of the petrol station when refuelling.

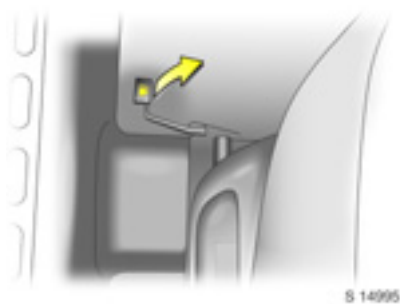

The tank flap is opened by pulling up the release lever located on the outboard side of the driver's seat.



The fuel filler neck is located on the left rear side of the vehicle.

To open fuel filler cap: turn it anti-clockwise.

Caution

Wipe off any overflowing fuel immediately.

Fuel consumption, CO₂ emissions

Directive 80/1268/EEC (last changed by 2004/3/EG) has applied for the measurement of fuel consumption since 1996.

The directive is oriented to actual driving practices: Urban driving is rated at approx. $\frac{1}{3}$ and extra-urban driving with approx. $\frac{2}{3}$ (urban and extra-urban consumption). Cold starts and acceleration phases are also taken into consideration.

The specification of CO₂ emission is also a constituent of the directive.

The figures given must not be taken as a guarantee for the actual fuel consumption of a particular vehicle. All values are based on the EU base model with standard equipment.

The calculation of fuel consumption as specified by directive 2004/3/EG takes account of the vehicle's kerb weight, ascertained in accordance with these regulations. Optional extras may result in slightly higher fuel consumption and CO₂ emission levels than those quoted.

Fuel consumption, CO₂ emissions
⇨ 12-4.

Vehicle care

Bonnet	10-2
Engine oil	10-3
Engine coolant	10-4
Windscreen/rear window washer fluid	10-5
Windscreen/rear window wipers	10-5
Brakes	10-6
Battery	10-6
Diesel fuel system, bleeding .	10-7
Bulb replacement.....	10-7
Fuses	10-11
Wheels	10-15
■ Tyre repair kit 3	10-18
Wheel changing	10-22
Jump starting 3	10-26
Towing	10-28
Interior care.....	10-29
Exterior care	10-30

General information

Accessories and vehicle modifications

We recommend the use of 'Opel genuine parts and accessories' expressly released for your vehicle type. Do not make any changes to the vehicle's electrical systems.

End-of-life vehicle recovery

Information on end-of-life vehicle recovery centres and the recycling of end-of-life vehicles is available at www.opel.com.

Vehicle checks

Warning

Only carry out engine compartment checks when the ignition is switched off.

The cooling fan can start to operate unexpectedly, even when the ignition is switched off.

Danger

Electronic ignition systems generate very high voltages. Do not touch the ignition system; high voltage can be fatal.

Bonnet



To open the bonnet, pull release lever  located on the driver's side of the vehicle, below the instrument panel.

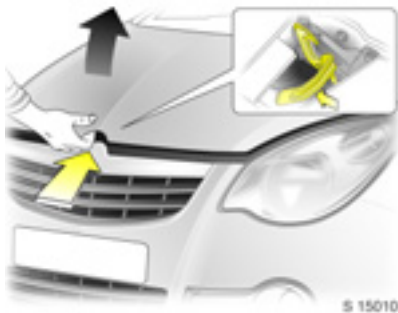

Locate the safety catch on the underside of the bonnet, push the catch to the left and lift the bonnet.

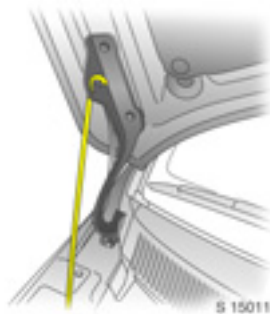

To hold the bonnet in the open position, disengage the support rod from its retaining clip.

Air intake ⇨ 8-6.

To close, lift bonnet slightly, release the support rod from the hole and press it back into its retaining clip. Lower the bonnet gradually, allowing it to drop from a height of approx. 30 cm.

Check that the bonnet is locked in position before driving, by pulling at its front edge. If it is not engaged, repeat closing procedure.

Engine oil

Information on engine oil is in the chapter "Service and maintenance" ⇨ 11-6.

We recommend the engine oil level is checked before starting a long trip.

The engine oil level must be checked with the vehicle horizontal and with the engine (which must be at operating temperature) switched off. Wait a few minutes before checking the level to allow the normal oil accumulation in the engine to drain back into the oil pan.

Pull out dipstick from the tube, wipe it clean and re-insert it as far as it will go. After pulling the dipstick out

again, check the engine oil level, ensuring it is between the lower and upper (**MIN** and **MAX**) marks.



The illustrations show checking the engine oil in the K 10 B and K 12 B petrol engines and the diesel engines respectively.

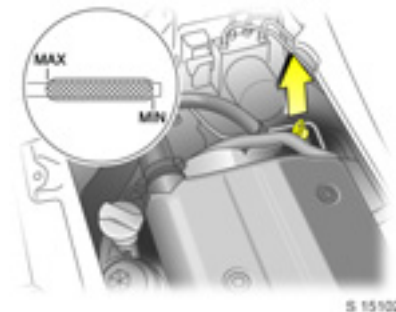
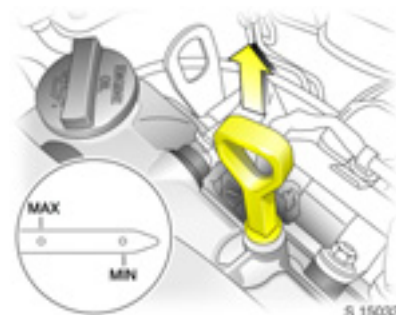

Top up if the engine oil level has dropped to the "add oil" lower mark (**MIN** mark).



When replenishing, attempt to use the same type of engine oil as used at the last oil change.

The engine oil level must not go above the upper (**MAX**) mark on the dipstick.

Caution

Overfilled engine oil must be drained or syphoned out.

Capacities ⇄ 12-5.

Engine oil life monitor ✱ ⇄ 5-14.

Engine coolant

Antifreeze and corrosion protection

The antifreeze provides freeze protection down to -28°C .

Caution

Use only approved antifreeze.

Coolant level



The illustrations show the **LOW** and **FULL** coolant level marks in the petrol and diesel engines respectively.



Warning

Allow engine to cool down before removing coolant filler cap. If steam is visible, move away from the vehicle until the engine is cool.

Remove coolant filler cap carefully so that pressure can escape slowly.

If it falls below the **LOW** mark when the system is cold, the coolant must be replenished.

Top up coolant level to the **FULL** mark, using a 50/50 mixture of antifreeze and distilled water. Ensure that the coolant level does not go over the **FULL** mark.

If no antifreeze is available, top up with distilled water and have the concentration checked and more antifreeze added as necessary.

Caution

Too low a coolant level can cause engine damage.

When closing, tighten coolant filler cap and ensure that the cap is returned to its original position (with the arrows on the cap and the tank aligned correctly).

Windscreen/rear window washer fluid

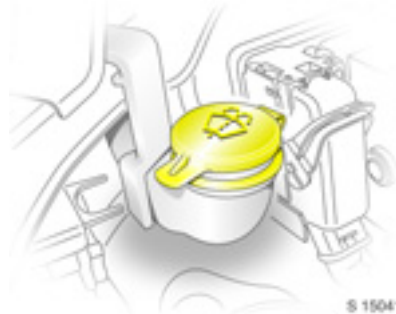

Fill only with clean water and washer fluid with antifreeze.

Windscreen/rear window wipers

Replacing windscreen wipers

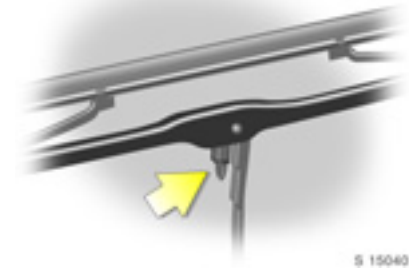

Lift wiper arm, press retaining clip towards wiper arm and detach wiper blade.

Replacing rear window wiper

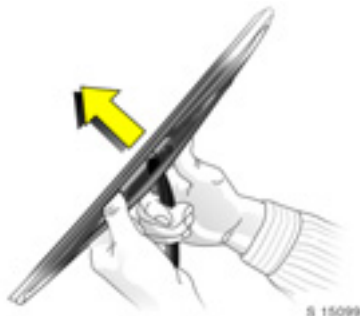

Lift wiper arm. Disengage wiper blade as shown in illustration and remove.

Brakes

Brake pads worn to their minimum thickness may generate a grinding noise. It is possible to continue driving.

Have your brake pads replaced as soon as possible.

Do not brake unnecessarily hard during the first 200 km (125 miles) after new brakes have been fitted.

Brake/clutch fluid level

Warning

Brake fluid is poisonous and corrosive. Do not allow it to contact eyes, skin, fabrics or painted surfaces; direct contact may cause injuries and damage.

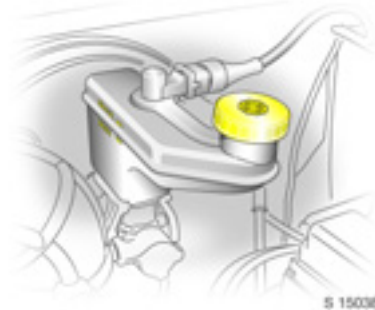

The brake fluid level in the reservoir must not be higher than the **MAX** mark or lower than the **MIN** mark.

Use only approved high performance brake fluid.

Extreme cleanliness is important, since brake fluid contamination can lead to brake system malfunctions.

After correcting the brake fluid level, seek the assistance of a workshop to rectify the cause of the fluid loss.

Battery

The battery is maintenance-free.

Batteries are not to be treated as household waste. They should be disposed of at a designated collection point for recycling.

Laying up the vehicle for more than 4 weeks can lead to battery discharge. Disconnect battery from on-board power supply by detaching negative terminal.

Ensure that the ignition is switched off before reconnecting the battery.

Control indicator  illuminates in the instrument cluster then extinguishes after the engine is started when the system has been correctly calibrated.

Diesel fuel system, bleeding

It is possible to restart the engine if the tank has been run dry.

With vehicle stationary, turn key to ignition switch position ON for more than 5 seconds, then turn to START. If engine does not start, wait approx. 15 seconds before repeating starting procedure.

If the engine will still not start, seek the assistance of a workshop.

Bulb replacement

Before replacing a bulb, switch off ignition and relevant switch.

Only hold new bulbs at base! Do not touch the bulb glass with bare hands.

Replacement bulb must be in accordance with data on base of defective bulb. Do not exceed wattage given on bulb base.

Headlamps

Battery removal

Diesel engines: for headlamp bulb replacement on the battery side, it is necessary to first disconnect and remove the battery then remove the coolant expansion tank and fuse box.

1. Switch off ignition and exterior lamps.
2. Open bonnet and disconnect battery by detaching negative (-) terminal followed by positive (+) terminal.

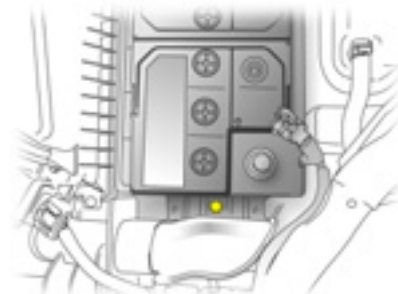

S 15186

3. Unscrew the retaining bolt using a suitable tool and remove battery, coolant expansion tank and fuse box.

When reinstalling the battery, reconnect the positive (+) terminal first and then the negative (-) terminal.

High beam and dipped beam

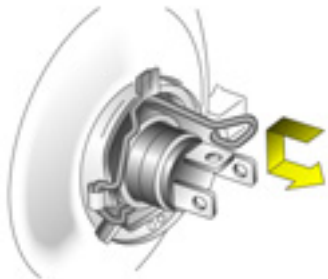

S 15023

1. Remove headlamp protective cover.
2. Detach plug connector from bulb.
3. Push retaining spring wire clip forward and unhook it.
4. Remove bulb from reflector housing and pull bulb straight out of socket.
5. Insert new bulb by pushing in and install in reflector housing.
6. Engage spring wire clip, and reattach plug connector to bulb.

7. Replace headlamp protective cover.

Parking lamps

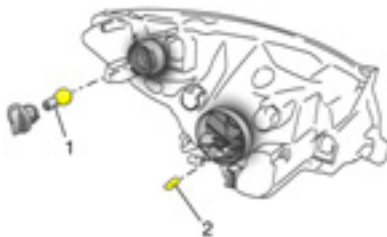

S 15376

1. Remove headlamp protective cover.
2. Remove parking lamp socket from reflector housing.
3. Remove bulb (2) from socket by pulling straight out.
4. Insert new bulb by pushing in.
5. Install parking lamp socket in reflector housing.
6. Replace headlamp protective cover.

Front turn signal lamps

1. Rotate bulb holder anti-clockwise and remove from reflector housing.
2. Push bulb (1) into socket slightly, rotate anti-clockwise and remove.
3. Insert new bulb and install bulb holder in reflector housing by rotating clockwise.

Front fog lamps *

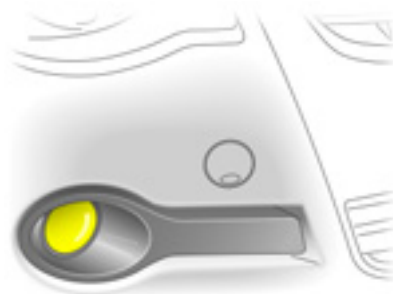

S 15027

Access the rear of the fog lamp from behind the front bumper.

1. Rotate bulb holder anti-clockwise and remove from reflector housing.

2. Remove bulb from socket by pulling straight out.
3. Insert new bulb by pushing in.
4. Insert bulb holder in reflector housing, rotate clockwise and engage in position.

If the bulb is inaccessible, seek the assistance of a workshop.

Rear combination lamps

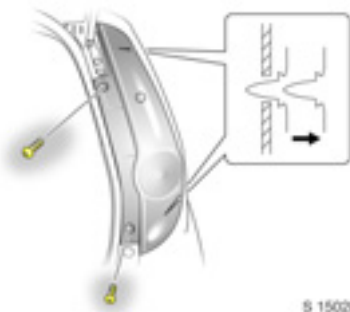

S 15028

1. Open tailgate.
2. Remove both screws on rear combination lamp assembly.
3. Pull lamp assembly away from vehicle, towards the rear.

4. Push bulb into socket slightly, rotate anti-clockwise and remove.
5. Insert new bulb.
6. Replace lamp assembly in original position, ensuring the upper and lower lugs are seated correctly.
7. Replace both screws on rear combination lamp assembly and close tailgate.

License plate lamps

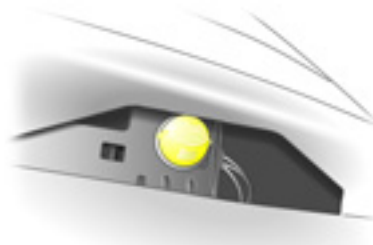

S 15029

1. Remove bulb holder by twisting it and pulling it away from the vehicle.
2. Remove bulb by pulling straight out.

3. Install new bulb by pushing in.
4. Replace bulb holder in original position.

Luggage compartment lamp



S 15031

1. Using a suitable screwdriver covered by a cloth, pry lens away from aperture.
2. Remove bulb by pulling straight out.
3. Insert new bulb by pushing in.
4. Reinstall lens in aperture.

Sidemarker lamps

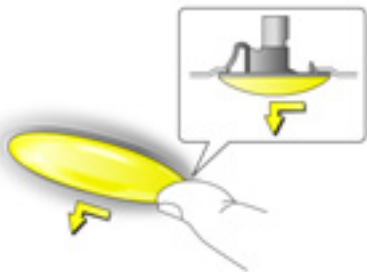

S 15162

As the bulb is built-in the lamp assembly, the lamp assembly must be replaced.

1. Slide lamp assembly towards rear of vehicle.
2. Remove lamp assembly and replace.
3. Install new lamp assembly in aperture.

Centre high-mounted stoplamp (CHMSL)

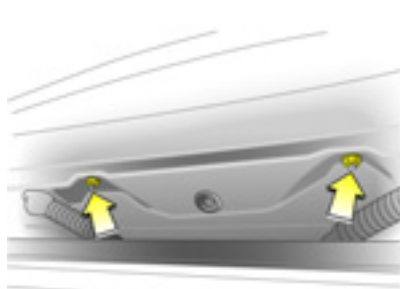

S 15157

1. Open tailgate and remove both bolts on underside of tailgate.
2. Close tailgate.
3. Remove lamp assembly from tailgate.

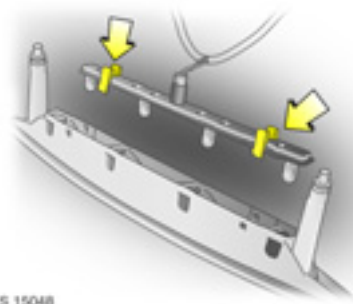

S 15048

4. Pinch both prongs on bulb holder together simultaneously and remove bulb holder from lamp assembly.
5. Remove bulbs by pulling them straight out.
6. Insert new bulbs by pushing them in.
7. Replace bulb holder in lamp assembly and install lamp assembly in tailgate.
8. Open tailgate and replace bolts removed earlier.

Interior lamps



S 15030

1. Using a suitable screwdriver covered by a cloth, pry lens away from roof lining.
2. Remove bulb by pulling straight out.
3. Insert new bulb, ensuring contact springs hold the bulb securely.
4. Reinstall lens in roof lining by pushing it back into original position.

Instrument illumination

Have bulbs replaced by a workshop.

Electrical system

Fuses

Only install fuses of the specified rating. Each fuse has its rating written on it, in addition the fuses are colour coded.

There are two fuse boxes in the vehicle: the instrument panel fuse box is located on the left-hand side of the vehicle below the instrument panel and the engine compartment fuse box is located next to the battery.

It is advisable to carry a full set of fuses.

Spare fuses can be kept in the engine compartment fuse box.

When replacing a fuse, turn off the respective switch and the ignition.

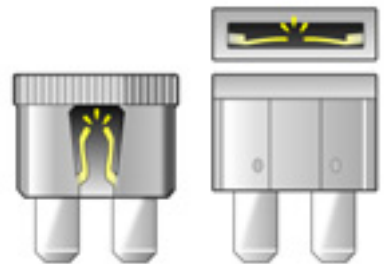

S 15084



S 15085

10-12 Vehicle care

A defective fuse can be recognized by its melted wire. A new fuse should only be installed after the cause of the trouble has been eliminated.

To help in replacing fuses, a fuse extractor is located in the instrument panel fuse box and in the engine compartment fuse box.

Do not use tools that conduct electricity when changing fuses.

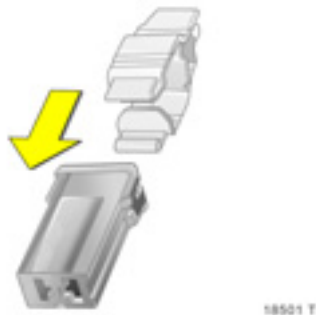
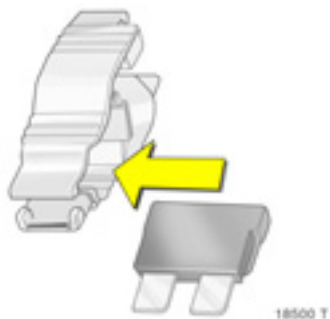
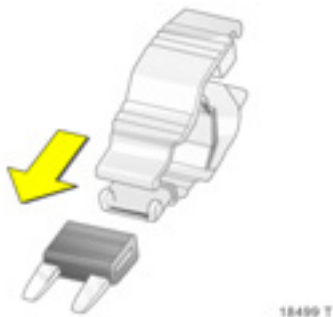

Instrument panel fuse box

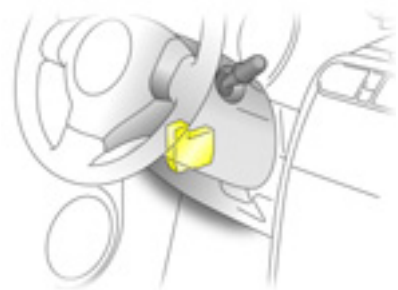

S 15018

Located on the left-hand side of the vehicle, below the instrument panel.

To open the fuse box, push the cover at both ends and remove.

Do not store any objects behind the cover.

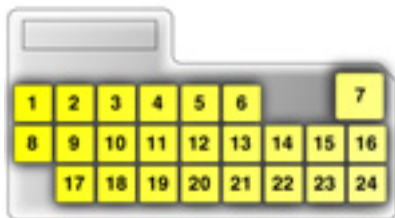

S 15019

Some circuits may be protected by several fuses.

No. Circuit

- 1 -
- 2 Ignition coils
- 3 Reversing lamp
- 4 Instrument cluster
- 5 Accessory socket, cigarette lighter, power exterior mirror
- 6 Infotainment system
- 7 Power window
- 8 Wipers/washer

No. Circuit

- 9 Power steering
- 10 Airbag system
- 11 ABS, ESP
- 12 Tail lamp
- 13 -
- 14 Door lock
- 15 Diesel engine
- 16 Starter motor
- 17 -
- 18 Heater fan
- 19 Rear fog lamp
- 20 Infotainment system
- 21 Heated rear window
- 22 Horn, hazard warning
- 23 Manual transmission
- 24 Power windows

Engine compartment fuse box

⚠ Danger

Switch off ignition before opening the engine compartment fuse box.

Petrol engines



S 15020

The fuse box is located next to the battery in the engine compartment. To open, disengage cover and tilt upwards.

10-14 Vehicle care

Do not store any objects behind the cover.

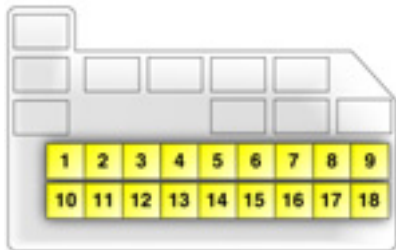

S 15021

Some circuits may be protected by several fuses.

No. Circuit

- 1 Heater fan
- 2 Fuel injection
- 3 Air conditioning compressor
- 4 Automatic transmission
- 5 Brake lamp switch
- 6 ABS, ESP
- 7 Starter motor

No. Circuit

- 8 -
- 9 Power steering control module
- 10 Ignition switch
- 11 Radiator fan
- 12 -
- 13 ABS, ESP
- 14 -
- 15 Engine electrics
- 16 Front fog lamps
- 17 Headlamp (left)
- 18 Headlamp (right)

Diesel engines

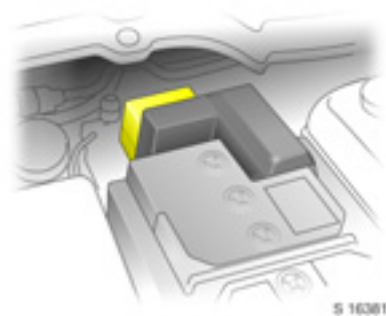

The fusebox is located behind the rear of the battery.

To open, disengage cover and lift upwards.

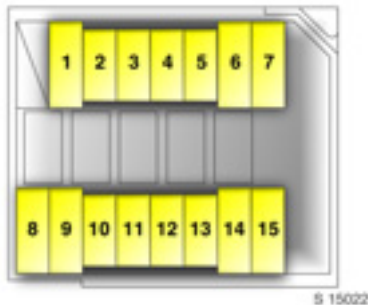

Some circuits may be protected by several fuses.

No. Circuit

- 1 Starter motor
- 2 Air conditioning compressor
- 3 Fuel pump
- 4 Fuel injection
- 5 Heater fan
- 6 Radiator fan
- 7 Power steering control module
- 8 ABS, ESP

No. Circuit

- 9 ABS, ESP
- 10 Brake lamp switch
- 11 Headlamp (right)
- 12 Headlamp (left)
- 13 Front fog lamps
- 14 Ignition switch
- 15 Ignition switch, power windows, wipers, starter

Wheels

Tyres

Factory-fitted tyres are matched to the chassis and offer optimum driving comfort and safety.

Winter tyres *

Tyres of size 165/70 R 14 and 185/60 R 15 may be used as winter tyres.

Winter tyres improve safety at temperatures below 7 °C and should therefore be fitted on all the wheels.

Depending on national regulations, a notice indicating the maximum permissible speed for the tyres must be affixed within the driver's field of vision.

The maximum permissible speed varies from country to country on account of national regulations.

Ensure that winter tyres are inflated to the correct pressure specified by the tyre manufacturer.

10-16 Vehicle care

Tyre designations

Meanings:

e.g. **185/60 R 15 84 T**

185 = Tyre width in mm

60 = Aspect ratio
(tyre height to tyre width
in %)

R = Belt type: **Radial**

15 = Rim diameter in inches

84 = Load index
e.g.: 84 represents 500 kg

T = Speed code

Speed code letters:

Q = Up to 160 km/h (100 mph)

S = Up to 180 km/h (112 mph)

T = Up to 190 km/h (118 mph)

H = Up to 210 km/h (130 mph)

V = Up to 240 km/h (150 mph)

W = Up to 270 km/h (168 mph)

Tyre pressure



Tyre pressures \varnothing 12-8.

Also may be shown on a label located on the driver's door pillar.

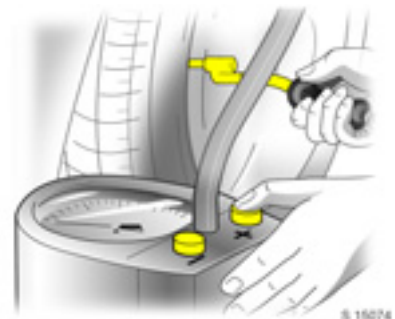

After having checked the tyre pressures, securely tighten the valve caps.

The specified tyre pressures are valid for cold tyres. The increased tyre pressure resulting from extensive driving must not be reduced. The tyre pressures specified apply to both summer and winter tyres.

Incorrect tyre pressures will impair safety, vehicle handling, comfort and fuel economy and will increase tyre wear.

⚠ Warning

If the pressure is too low, this can result in considerable tyre warm-up and internal damage, leading to tread separation and even to tyre blow-out at high speeds.

Tyre condition

Drive over edges slowly and at a right angle if possible. When parking, ensure that the tyres are not pressed against the edge of the kerb.

Check tyres regularly for damage (foreign bodies, punctures, cuts, cracks, bulges in sidewalls). Check wheels for damage. In the event of damage or abnormal wear, seek the assistance of a workshop.

Different tyre and wheel types

If tyres of a different size to those fitted at the factory are used (this includes winter tyres), the electronic

speedometer may possibly need to be reprogrammed, to ensure that the speed displayed is correct.

Caution

Use of unsuitable tyres or wheels may lead to accidents and render the vehicle unroadworthy.

Wheel covers *

Wheel covers and tyres that are approved for the vehicle and comply with all of the relevant wheel and tyre combination requirements must be used.

If the wheel covers and tyres used are not approved, make sure that the tyres do not have a beaded edge.

Remove wheel covers before fitting tyre chains, to avoid damaging the wheel covers.

Tyre chains *

Tyre chains are only permitted on the drive wheels (front axle). They must be fitted to the tyres symmetrically in order to achieve a concentric fit.

Use fine mesh chains that add no more than 10 mm to the tyre tread and the inboard sides (including chain lock).

Tyre chains may only be used at speeds of up to 50 km/h (30 mph) or up to the tyre chain manufacturer's recommended maximum speed, whichever is lower.

10-18 Vehicle care

Tyre chains must not be used on the temporary spare wheel.

Tyre repair kit *

Minor damage to the tyre tread can be temporarily repaired with the tyre repair kit.

Do not remove foreign bodies from the tyres. Damaged areas bigger than 4 mm and damage at the tyre rim cannot be repaired using the tyre repair kit.

Never use the liquid sealant on more than one tyre at a time.

Warning

Do not drive faster than 80 km/h (50 mph).

Do not use for a lengthy period.

Steering and handling may be affected.



The tyre repair kit is stowed beneath the floor carpet in the luggage compartment ↗ 4-4.

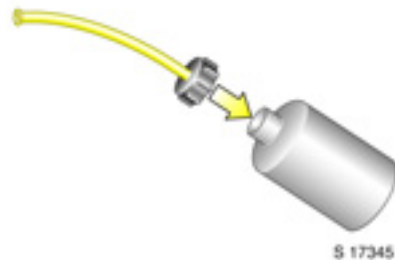

1. If you have a flat tyre: Shake sealant bottle, remove cap and screw filler hose on to bottle, to pierce inner cap.

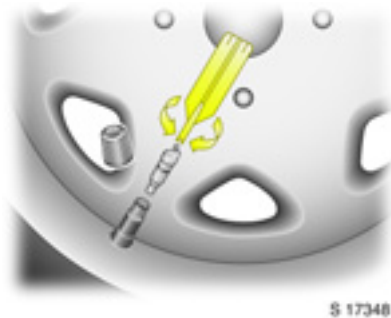

S 17348

2. Unscrew valve cap from defective tyre and unscrew valve insert using supplied remover.

⚠ Warning

The air remaining in the tyre can cause the insert to be forced out under pressure during removal.

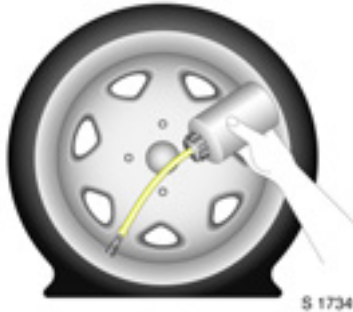

S 17349

3. Remove the plug from the end of the filler hose and insert filler hose onto tyre valve.
4. Hold the sealant bottle with bottom pointing upwards and squeeze all of the sealant into the tyre.
5. Disconnect filler hose and firmly screw insert into valve using the valve insert remover.
If necessary, use the supplied spare valve insert.

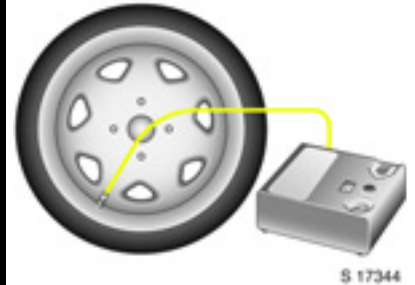

S 17344

6. Place the compressor unit on level ground and unwrap the air compressor hose from the compressor unit.
Ensure the compressor on/off switch is in position **O** (off) and screw the hose on to tyre valve.

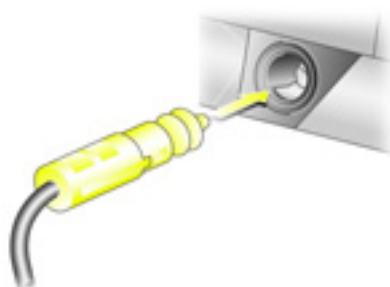

S 17350

7. Unwrap accessory plug lead from the compressor unit. Insert plug into accessory socket.
8. Turn ignition key to position ACC.



S 17351

9. Switch compressor on/off switch to position I (on).
10. Inflate the tyre to the correct pressure φ 12-8.
If there is no reading, the air compressor hose to tyre valve connection may be faulty. Re-check the connection.

If the required tyre pressure is not obtained within 10 minutes, rotate the tyre to evenly spread the sealant and repeat the procedure.

If the required tyre pressure is still not obtained, the tyre is too badly damaged. Seek the assistance of a workshop.

If the tyre is overinflated, reduce the pressure by pressing the deflation button on the compressor.

Do not operate the compressor for more than 10 minutes, to avoid overheating.

11. When the correct tyre pressure has been reached, switch compressor on/off switch to position O (off).
12. Remove accessory plug from the accessory socket, detach air compressor hose from tyre valve and replace valve cap.
13. Return air compressor hose and accessory plug lead to their original locations in the compressor unit.

14. Remove any excess sealant using a cloth.



15. Attach supplied sticker containing the maximum permitted speed within the driver's field of view.
16. Continue driving immediately so that sealant is evenly distributed throughout the tyre.
- After driving approx. 5 km (3 miles) (but no more than 10 minutes), stop and check tyre pressure, using the compressor.

17. If the tyre pressure has not dropped below 130 kPa (1.3 bar), it may be adjusted to the prescribed value. Repeat the procedure until there is no more loss of pressure.

If the tyre pressure has dropped below 130 kPa (1.3 bar), the vehicle must not be driven. Seek the assistance of a workshop.

18. Stow tyre repair kit below the floor carpet in the luggage compartment.

Note

The driving characteristics of the repaired tyre is severely affected, therefore have this tyre replaced.

If unusual noise is heard or the compressor becomes hot, turn compressor off for at least 30 minutes.

Pay attention to storage information and best before date on sealant bottle. Its sealing capability is not guaranteed after this time.

The sealant bottle can only be used once. Replace used sealant bottle.

Dispose of used tyre repair kits in accordance with the applicable laws.

Wheel changing

In order to reduce the chance of possible injuries, make the following preparations and note the procedure:

- Park on a level, firm and non-slippery surface.
- Switch on hazard warning lamps and apply parking brake. Engage reverse gear (automatic transmission * in P).
- Take the spare wheel from under the luggage compartment floor cover ↷ 10-24.
- Before raising the vehicle, turn front wheels to straight-ahead position.
- Never change more than one wheel at a time.
- Block wheel diagonally opposite the wheel to be changed, by placing wedge blocks or equivalent in front and behind the wheel.
- Use jack only when changing wheels.
- If the ground on which the vehicle is parked is soft, a solid board (max. 1 cm thick) should be placed under

the jack. Using a thicker board could lead to damage of the jack and the vehicle.

- Do not raise the vehicle more than is necessary to change a wheel.
- No people or animals may be in the vehicle when it is jacked-up.
- Never start or run the engine or crawl under a jacked-up vehicle.
- Before screwing on the wheel bolts when changing a wheel, apply a light coating of grease to the cone of each wheel bolt.

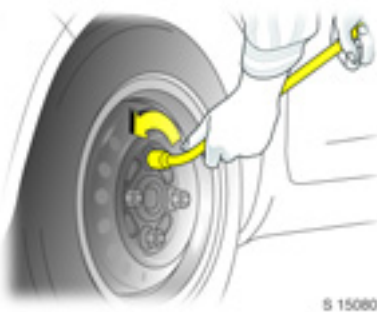

1. Prise off the wheel cover *.

2. Slacken the wheel bolts by one turn each using the wheel bolt wrench, putting the wrench on as far as possible.

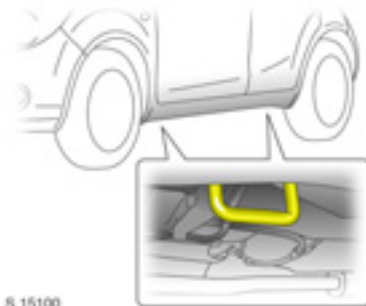

3. The location of front and rear jacking bars may be indicated by notches on the bottom edge of the vehicle, under the doors.



S 15298

4. Attach the jack handle to the wheel bolt wrench (as shown in illustration) and insert hook end of jack handle through jack eye. Before positioning the jack, set it to the necessary height by rotating the jack handle clockwise using the attached wheel bolt wrench.

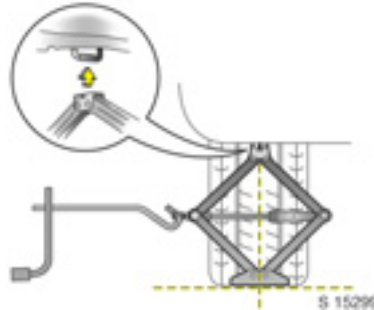

5. Position jack at the front or rear jacking point located nearest to the wheel concerned so that the jack claw spans the vertical base. Make sure it is properly positioned, ensuring the jacking bar fits securely into the jack head groove. The jack base must be on the ground directly below the jacking point in a manner that prevents it from slipping.

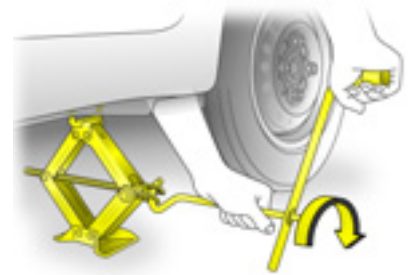

S 15300

6. Rotate jack handle clockwise using the attached wheel bolt wrench to raise vehicle. Raise the vehicle until the wheel is just clear of the ground.
7. Unscrew wheel bolts completely by turning anti-clockwise and wipe clean with a cloth. Put wheel bolts somewhere where the threads will not be soiled.

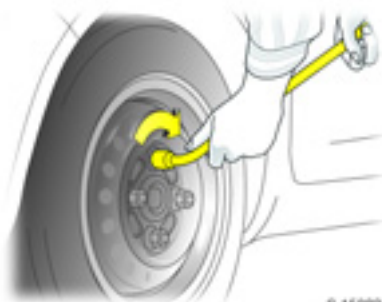

S 15083

8. Remove wheel and install spare wheel.
9. Screw on wheel bolts and tighten slightly by hand until wheel is held against the hub.
10. Apply a light coating of grease to the cone of each wheel bolt. Do not grease the threads.
11. Rotate jack handle anti-clockwise using the attached wheel bolt wrench to lower vehicle to the ground.

12. Tighten wheel bolts to the correct torque (85 Nm) in a cross wise sequence, putting the wheel bolt wrench on as far as possible.
13. Stow replaced wheel in luggage compartment.
14. Stow the warning triangle * and jacking equipment ⇨ 4-5, 10-25.

Temporary spare wheel

The temporary spare wheel is designed for use on your vehicle only. Do not attempt to use the spare tyre on a different wheel, or use a different tyre on the spare wheel, as they will not fit.

Ensure the temporary spare wheel is inflated to the correct tyre pressure ⇨ 12-8.

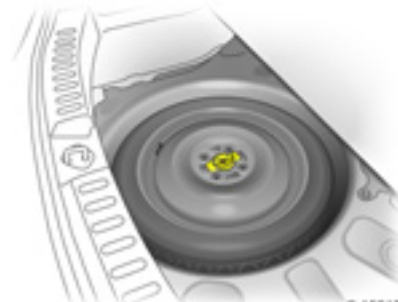

S 15017

The temporary spare wheel is located in the luggage compartment and is secured with a screw-in retainer.

To access the spare wheel, open tailgate and pull up luggage compartment floor carpet using the central strap located near the tailgate latch and hang the string on the hook provided ⇨ 4-4.

If equipped, remove the under floor storage compartment * from the luggage compartment by pulling it up by the handle located near the tailgate latch, to access the spare wheel ⇨ 4-4.

Remove the retainer by rotating it anti-clockwise, and remove spare wheel from the spare wheel well.

General information

If you use winter tyres ✱, the spare wheel may still be fitted with a summer tyre.

If you use the spare wheel when it is fitted with a summer tyre, the vehicle's driveability may be affected, especially on slippery road surfaces.

Obtain a replacement for the faulty tyre as soon as possible, and have the wheel balanced and fitted to the vehicle.

- Using a temporary spare wheel may change the driving behaviour of the vehicle, particularly if using winter tyres ✱. Replace defective tyre as quickly as possible, balance wheel and fit to vehicle.
- Fit only one temporary spare wheel.
- Do not drive faster than 80 km/h (50 mph).
- Take curves slowly.

- Do not use the temporary spare wheel for a lengthy period.
- Replace temporary spare wheel with full specification wheel without delay.
- When temporary spare wheel is fitted, do not take the vehicle through an automatic car wash with guide rails. The temporary spare wheel may get caught on the rails, causing damage to the tyre, wheel and other vehicle parts.
- Tyre chains are not permitted on the temporary spare wheel.
- If tyre chains are necessary after a front wheel puncture, fit the temporary spare wheel to the rear and a rear wheel to the front. Check tyre pressure and adjust if necessary ⇨ 12-8.

Tools



To access the jack, vehicle tools and tyre repair kit ✱ (⇨ 10-18), open tailgate and pull up luggage compartment floor carpet using the central strap located near the tailgate latch and hang the string on the hook provided ⇨ 4-4.

The jack and vehicle tools are located below the spare wheel.

If equipped, remove the under floor storage compartment ✱ from the luggage compartment by pulling it up by the handle located near the tailgate latch ⇨ 4-4.

Rotate jack shaft anti-clockwise and remove jack from storage bracket.

To stow the jack after use, place it in its storage bracket and turn jack shaft clockwise until jack is held securely in place.

Jump starting ✱

Do not start with quick charger, to prevent damage to electronic components.

Warning

This must be done with extreme care. Any deviation from the following instructions could lead to personal injury or damage resulting from battery explosion, as well as to damage to the electrical systems in both vehicles.

Never expose the battery to naked flames or sparks.

- A discharged battery can freeze at temperatures of 0 °C. Defrost the battery in a warm room before connecting the jump leads.
- Do not allow battery fluid to contact eyes, skin, fabrics or painted surfaces. The fluid contains sulphuric acid which can cause injuries and damage in the event of direct contact.

- Wear eye protection and protective clothing when handling a battery.
- Use auxiliary battery with same voltage (12 volts). Its capacity (Ah) must not be considerably less than that of the discharged battery. Voltage and capacity information can be found on the batteries.
- Use jump leads with insulated terminals and a width of at least 16 mm² (25 mm² for diesel engines).
- Do not disconnect the discharged battery from the vehicle.
- Switch off all unnecessary electrical consumers. Infotainment system may be damaged if switched on while jump starting.
- Do not lean over the battery during jump starting procedure.
- Do not allow the terminals of one lead to touch those of the other lead.
- The vehicles should not touch while jump starting.
- Apply parking brake.

- Manual transmission in neutral, automatic transmission * in P.

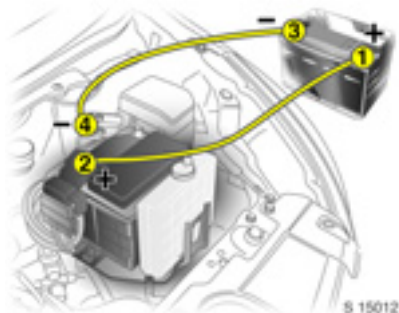

Connect the leads in the order shown in the illustration:

1. Connect one end of the first jump lead to the positive terminal **1** of the battery providing the jump start (identified by “+” sign on battery case or terminal).
2. Connect the other end of the first jump lead to the positive terminal **2** of the discharged battery (“+” sign).

3. Connect one end of the second jump lead to the negative terminal **3** of the battery providing the jump start (identified by “-” sign on battery case or terminal).
4. Connect the other end of the second jump lead **4** to ground on the vehicle with the discharged battery, e.g. on the engine block.

Warning

Care must be taken to ensure that the leads do not inadvertently contact metal surfaces within the compartment area.

- Do not connect leads to negative terminal of discharged battery.
- The last connection point should be as far away from the discharged battery as possible.
- Route leads so they cannot catch on rotating parts in engine compartment.
- Start the engine of the vehicle providing the jump start.

- After 5 minutes, start the other engine. Start attempts should be made at intervals of 1 minute and should not last longer than 15 seconds.
- After starting, allow both engines to idle for approx. 3 minutes with leads connected.
- In order to avoid excess voltage in the electrical system, before removing a lead, switch on an electrical consumer (e.g. lamps, heated rear window) in the vehicle receiving the jump start.
- Operate discharged vehicle for approx. 20 minutes to allow for recharging.
- Reverse above sequence exactly when removing leads.

Towing

Towing the vehicle

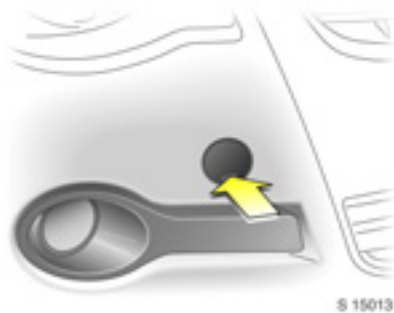

Towing from the front is permissible in emergency situations only.

For fixing of the front towing eye, remove the towing eye socket cover by pressing the lower part of the cover.

The towing eye attachment is stored below the spare wheel in the luggage compartment ⇨ 10-25.

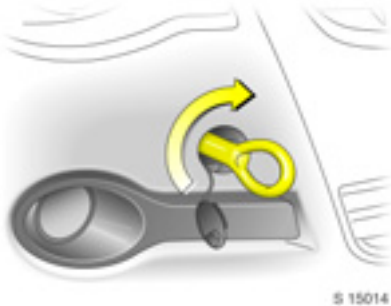

Screw in towing eye attachment clockwise until it is firmly in place. If necessary, use jack handle to tighten.

Attach a tow rope * - or better still a tow rod * - to the front towing eye.

The front towing eye must only be used for towing and not recovering the vehicle.

Switch on the ignition (⇨ 9-1) to release the steering column lock and to permit operation of the brake lamps and windscreen wipers.

Manual transmission in neutral, automatic transmission * in **N**.

Caution

Drive slowly and avoid jerky movements. Impermissible tractive forces could damage the vehicles.

More brake pedal pressure is necessary when braking since the brake servo unit is operative only when the engine is running.

Considerably greater steering force is necessary since this unit is operative only when the engine is running.

To prevent entry of exhaust fumes from towing vehicle, switch on air recirculation mode (⇨ 8-3) and close the windows.

Do not tow the vehicle with a tow rope * or tow rod * for extended periods, to avoid causing damage to the vehicle. Only tow in this manner on hard-surfaced roads.

Vehicles with manual or automatic transmission * can be towed from the front, provided the front axle is raised off the ground and the parking brake is released.

Vehicles with manual transmission can also be towed from the front with all four wheels on the ground. In this case, the gearshift lever must be in neutral with the parking brake released and the key in ignition switch position ACC, to permit release of the steering column lock before towing.

Seek the assistance of a workshop.

Caution

Never tow the vehicle with the front wheels on the ground, to avoid causing damage to the automatic transmission ❄.

After towing, unscrew the towing eye attachment anti-clockwise and refit the cover.

Towing another vehicle

Caution

The rear lashing eye is designed for shipping purposes only.

Towing another vehicle from the rear is not permitted!

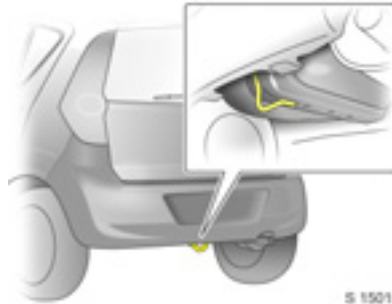

Interior care

Interior and upholstery

Clean the vehicle interior regularly, including the instrument panel facia, using Interior/Upholstery Cleaner.

Clean fabric upholstery with a vacuum cleaner and brush. To remove stains, use a cleaner that is suitable for both fabrics and vinyl.

Caution

Open Velcro fasteners on clothing could damage seat upholstery. Make sure that Velcro fasteners are closed.

Clean seat belts only with lukewarm water or Interior/Upholstery Cleaner.

Exterior care

Locks

The locks are lubricated with a high-grade lock cylinder grease at the factory.

Only use de-icing agents in emergencies, as they have a degreasing effect and will impair the function of the locks. After using a de-icing agent, have the locks regreased. Seek the assistance of a workshop.

Washing the vehicle

The paintwork of your vehicle is exposed to environmental influences, e.g. continuous changes in weather conditions, industrial waste gases and dust or thawing salts, so wash and wax your vehicle regularly. When using automatic car washes, select a program which includes waxing.

Bird droppings, dead insects, resin, pollen and the like should be cleaned off immediately, as they contain aggressive constituents which can cause paint damage.

If using a car wash, comply with the pertinent instructions of the car wash manufacturer. The windscreen wipers and rear window wiper must be switched off ⇨ 5-2, 5-3. Remove detachable rod antenna by unscrewing it.

Do not use high-pressure jet cleaners.

If you wash your vehicle by hand, make sure that the insides of the wings are also thoroughly rinsed out. Do not use household dishwashing liquid, to avoid removing wax from the paintwork.

Clean edges and folds on opened doors and flaps as well as the areas they cover.

Thoroughly rinse off and leather-off the vehicle. Rinse leather frequently. Use separate leathers for paint and window surfaces; remnants of wax on the windows will impair vision.

Also wash aluminium trim parts, avoiding the use of abrasive materials such as automotive or

chrome polish, steam or caustic soap. Washing with water is normally sufficient.

Observe national regulations.

Exterior lamps/lenses

Headlamp and other protective lamp bezels are made of plastic. If they require additional cleaning after the vehicle has been washed, clean them with Car Shampoo. Do not use any abrasive or caustic agents, do not use an ice scraper, and do not clean them dry.

Waxing

Wax your vehicle regularly, in particular after it has been washed using Car Shampoo and at the latest when water no longer forms beads on the paintwork, otherwise the paintwork will dry out.

Also wax aluminium trim parts, edges and folds on opened doors and flaps as well as the areas they cover.

Polishing

Polishing is necessary only if the paint has become dull or if solid deposits have become attached to it. Paintwork polish with silicone forms a protective film, making waxing unnecessary.

Plastic body parts should not be treated with wax and polish.

Use Metallic Paintwork Wax on vehicles with a metallic-effect paint finish.

Plastic and rubber parts

For additional cleaning of plastic and rubber parts, use a cleaner suitable for vehicle interiors. Do not use any other agent, and in particular do not use solvents or petrol.

Windows and wiper blades

When cleaning the heated rear window, make sure that the heating element on the inside of the window is not damaged. Never place stickers on the inside of the rear window.

Use a soft, lint-free cloth or chamois leather, in conjunction with Window Cleaning Spray and Insect Remover. Do not use sharp instruments or abrasive cleaners.

Windscreen Wash Solvent is suitable for de-icing windows.

For mechanical removal of ice, use a commercially available sharp-edged ice scraper. Press the scraper firmly against the glass so that no dirt can get under it and scratch the glass.

Wax, such as that used in car washes, can cause streaks to form on the windscreen when the wipers are used.

Wiper blades can be cleaned with a soft cloth and Windscreen Wash Solvent. Do not use abrasive cleaners.

Tyres and wheels

Do not use high-pressure jet cleaners on wheels and tyres.

Use a pH-neutral wheel cleaning agent to clean the wheels.

Avoid using abrasive materials and brushes that can damage the finish.

Wheels are painted and can be treated with the same agents as the body. For alloy wheels ✱, we recommend the use of Alloy Wheel Preserver.

Paint damage

Repair small areas of paint damage such as stone impacts, scratches etc. before rust can form. If rust has already formed, have the cause remedied. Seek the assistance of a workshop.

Underbody

Your vehicle has a factory-applied PVC undercoating in the wheel arches (including the longitudinal members) which provides permanent protection and needs no special maintenance. The surfaces of the vehicle underbody not covered by PVC are provided with a durable protective wax coating in critical areas.

On vehicles which are washed frequently in automatic car washes with underbody washing facility, the protective wax coating may be impaired by dirt-dissolving additives. Check the underbody after washing and have it waxed if necessary. Before the start of the cold weather season, check the PVC coating and protective wax coating and, if necessary, have them restored to perfect condition.

The underbody should be washed following the end of the cold weather season to remove any dirt adhering to the underbody since this may also contain salt. Check protective wax coating and, if necessary, have it restored to perfect condition.

Engine compartment

Areas of the engine compartment that are painted in the same colour as the vehicle must be looked after like any other painted surface.

It is advisable to wash the engine compartment before and after winter and preserve it with wax. Cover

alternator and fluid reservoirs with plastic sheets before washing the engine.

When washing the engine with a steam-jet cleaner, do not direct the steam-jet at components of the Anti-lock Brake System (ABS), the air conditioning system * or the belt drive and its components.

Protective wax that has been applied is also removed during the engine wash. For this reason, have the engine, brake system components in the engine compartment, axle components with steering, body parts and cavities thoroughly preserved with protective wax after the wash.

An engine wash can be performed in the spring in order to remove dirt that has adhered to the engine compartment, which may also have a high salt content. Check protective wax layer and make good if necessary.

Service and maintenance

Scheduled maintenance	11-1
Service schedule	11-2
Additional servicing	11-5
Recommended fluids and lubricants	11-5

Scheduled maintenance

Service intervals

Interim Service

Due every 15,000 km (10,000 miles) or 1 year, whichever occurs first.

Main Service

Due every 30,000 km (20,000 miles) or 2 years, whichever occurs first.

The service intervals are based on average operating conditions. For severe operating conditions ⇨ 11-5.

Service interval display ⇨ 5-14.

Engine oil life monitor ⇨ 5-14.

Confirmations

Confirmation of Service is recorded in the spaces provided in the Service and Warranty Booklet. The date and kilometre/mileage reading is completed with the stamp and signature of the Servicing Workshop.

Make sure that the Service and Warranty Booklet is completed correctly as continuous proof of service is essential if any warranty or goodwill claims are to be met, and is also a benefit when you come to sell the vehicle.

11-2 Service and maintenance

Service schedule

Service operations	by year ¹⁾						
	1	2	3	4	5	6	
	km (x 1000) ¹⁾	30	45	60	75	90	
	miles (x 1000) ¹⁾	10	20	30	40	50	60
Controls, lighting, signalling equipment and airbags: visual check	x	x	x	x	x	x	x
Remote control batteries: replace	every 2 years						
Windscreen wipers, windscreen washer system: check, correct	x	x	x	x	x	x	x
Coolant level and antifreeze: check, correct	x	x	x	x	x	x	x
Hoses: check for tightness and secure seating							
Coolant: change	every 3 years/45,000 km/30,000 miles						
Brake fluid level: check, correct	x		x		x		
Battery terminals: check for secure connections and battery eye	x	x	x	x	x	x	x
Pollen filter: replace		x		x			x
● More often for when dust, sand or pollen is in the air	agreement with customer						
● Air cleaner element: inspect - petrol engines only	x	x	x	x	x	x	x
Air cleaner element: replace - petrol and diesel engines			x				x
⊕ Spark plugs: replace	every 7 years/105,000 km/70,000 miles						

¹⁾ Whichever occurs first.

⊕ Additional operations.

● Under extreme operating conditions and if required by country-specific conditions, the intervals are reduced.

Service operations	by year ¹⁾						
	1	2	3	4	5	6	
	km (x 1000) ¹⁾	30	45	60	75	90	
	miles (x 1000) ¹⁾	20	30	40	50	60	
Ribbed V-belt: visual check - petrol engines only			x			x	
⊕ Replace	every 6 years/90,000 km/60,000 miles						
Ribbed V-belt and tensioner: visual check - diesel engines only		x		x		x	
⊕ Replace	every 10 years/150,000 km/100,000 miles						
⊕ Valve clearances: check, adjust - petrol engines only		x		x		x	
Engine oil and oil filter: replace	x	x	x	x	x	x	
● Diesel fuel filter: drain water	x	x	x	x	x	x	
Diesel fuel filter: replace and bleed		x		x		x	
⊕ Manual transmission: oil level check, correct	x						
Oil change			x			x	
Parking brake cable: check, adjust	x						
Parking brake: check and adjust		x		x		x	
Wheel mounting and suspension front and rear, brake pressure hoses, fuel lines, fuel tank and exhaust system: visual check							
Corrosion protection: check and record in Service and Warranty Booklet	annually						
Front and rear wheel brakes: check visually	x	x	x	x	x	x	

¹⁾ Whichever occurs first.

⊕ Additional operations.

● Under extreme operating conditions and if required by country-specific conditions, the intervals are reduced.

11-4 Service and maintenance

Service operations	by year ¹⁾						
	1	2	3	4	5	6	
km (x 1000) ¹⁾	15	30	45	60	75	90	
miles (x 1000) ¹⁾	10	20	30	40	50	60	
●⊕ Automatic transmission fluid level: check correct		x		x		x	
Fluid hose: inspect						x	
Fluid: change	every 165,000 km/110,000 miles						
Engine, transmission, A/C compressor: check for leaks	x	x	x	x	x	x	
● Brake drum: remove, clean, visual check				x			
Steering system boots, track rods, final drive: visual check			x			x	
Track rod end and supporting ball joint: check		x		x		x	
⊕ Brake and clutch fluid: change	every 2 years						
Wheel fastening: loosen and tighten to torque	x	x	x	x	x	x	
Tyre condition and pressures: check, correct							
First aid kit: visual check	every 2 years						
Headlamp aiming: check, adjust		x		x		x	
Door hinges, door stop, lock cylinder, lock striker, bonnet catch, tailgate hinges and check links: lubricate		x		x		x	
Test drive, final check	x	x	x	x	x	x	
Service interval display and oil life monitor: reset - if applicable							

¹⁾ Whichever occurs first.

⊕ Additional operations.

● Under extreme operating conditions and if required by country-specific conditions, the intervals are reduced.

Additional servicing

Additional operations ⊕

Additional work is work that is not required every service but can be performed in conjunction with a regular service.

Time allowances for such work are not included in the scope of regular services and will be charged for additionally. It is more economic if these operations are performed as part of a scheduled service than having them performed separately.

Severe operating conditions ●

Operating conditions are classified as severe when one or more of the following occurs frequently:

- cold starts,
- stop and go,
- trailer/caravan towing,
- gradients and/or high altitudes,
- poor road surfaces,
- sand and dust,
- extreme temperature fluctuations.

Police vehicles, taxis and driving school vehicles are also classified as operating under severe conditions.

Under severe operating conditions, it may be necessary to have certain scheduled service work done more frequently than the scheduled intervals.

For example, if fuel is used that does not comply with required standards, the fuel filter may need more frequent draining or replacement and it may also be necessary to change other components more often (e.g. spark plugs).

It is recommended to seek technical advice on the servicing requirements dependent on the specific operating conditions of your vehicle.

Recommended fluids and lubricants

Only use products that have been tested and approved. Damage resulting from the use of non-approved materials will not be covered by the warranty.

Warning

Operating materials are hazardous and must be handled with the appropriate level of care. If consumed, seek medical attention immediately. Do not inhale fumes and avoid skin contact. Keep out of reach of children. Do not allow operating materials to contaminate the sewage system, surface water, ground water or soil. Dispose of empty containers properly. Always bear in mind that operating materials are hazardous to your health.

Checking and topping up fluids

◇ 10-3.

11-6 Service and maintenance

Engine oil

Engine oil is identified by its quality and also its viscosity. Quality is more important than viscosity when selecting which engine oil to use.

Engine oil quality

GM-LL-A-025: Petrol engines

GM-LL-B-025: Diesel engines

GM	General Motors Europe
LL	Longlife
A or B	Engine oil quality specification
025	Validity index

Opel engine oil meets classifications GM-LL-A-025 and GM-LL-B-025 and is therefore suitable for both petrol and diesel engines.

Topping up engine oil

Oils of different manufacturers and brands can be mixed as long as you comply with the specified engine oil criteria (quality and viscosity).

Not every engine oil available on the market meets the quality requirements, always check the required specification and rating is marked on the container.

If engine oil of the required quality is not available, a maximum of 1 litre of ACEA A3/B4 or A3/B3 grade may be used (only once between each oil change). The viscosity should be of the correct rating.

Use of ACEA A1/B1 and A5/B5 engine oil is expressly forbidden, since they can cause long-term engine damage under certain operating conditions.

Engine oil additives

The use of engine oil additives could cause damage and invalidate the warranty.

Engine oil viscosity

Diesel engines:

SAE 0W-30, 0W-40, 5W-30 or 5W-40

Petrol engines:

SAE 5W-30

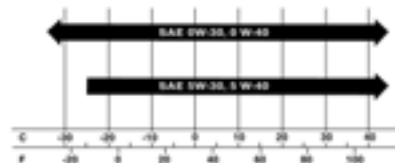

S 15196

The SAE viscosity rating defines the ability of an oil to flow. When cold, oil is more viscous than when hot.

Multigrade oil is indicated by two figures. The first figure, followed by a W, indicates low temperature viscosity and the second figure the high temperature viscosity.

Coolant and antifreeze

Use antifreeze of recommended specification.

The system is factory-filled with coolant designed for frost protection down to approx. -28 °C. This concentration should be maintained all year-round.

Coolant additives intended to give additional corrosion protection or seal against minor leaks can cause function problems. Liability for consequences resulting from the use of coolant additives will be rejected.

Brake and clutch fluid

Only use DOT4 brake fluid.

Warning

Brake fluid is poisonous!

Over time, brake fluid absorbs moisture which will reduce braking effectiveness. The brake fluid should therefore be replaced at the specified interval.

Brake fluid should be stored in a sealed container to avoid water absorption.

Ensure it does not become contaminated with fluids containing mineral oil (oil, petrol, cleaner) as this can damage the seals and sleeves of the brake system.

Caution

Due to its corrosive nature, it must not come in contact with the paintwork. Flush any escaped brake fluid with plenty of water.

Transmission fluid

Use fluid meeting specification

Grade: API GL-4

Viscosity: 75W-85 or 75W-90.

Automatic transmission fluid

Use fluid meeting specification

ATF3309.

Technical data

Vehicle identification.....	12-1
Engine data	12-3
Performance.....	12-4
Fuel consumption, CO2 emission.....	12-4
Capacities.....	12-5
Dimensions.....	12-6
Vehicle weights	12-7
Tyre pressures in kPa/bar	12-8

Vehicle identification

Vehicle Identification Number (VIN)



The technical data is determined in accordance with European Community standards. We reserve the right to make modifications. Specifications in the vehicle documents always have priority over those given in this manual.

The Vehicle Identification Number (VIN) is on the vehicle identification plate, located on the driver's door pillar, visible with the door open.

Vehicle identification plate

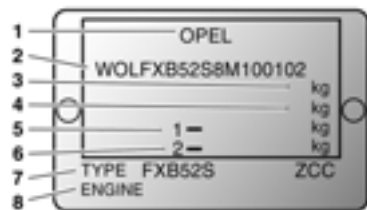

S 15045

Information on identification plate:

- 1 Manufacturer
- 2 Vehicle Identification Number
- 3 Permissible Gross Vehicle Weight
- 4 Permissible Gross Train Weight
- 5 Maximum permissible front axle load
- 6 Maximum permissible rear axle load
- 7 Type approval number
- 8 Engine designation

The combined total of front and rear axle loads must not exceed the permissible Gross Vehicle Weight.

For example, if the front axle load is being fully utilized, the rear axle can only bear a load that is equal to the Gross Vehicle Weight minus the front axle load.

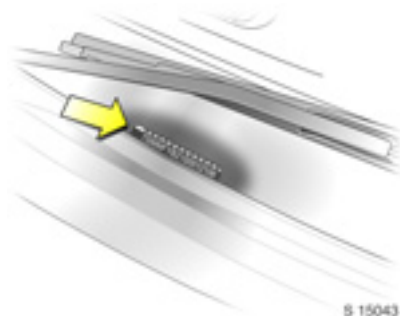

The visible VIN may also be stamped on a plate and affixed to the instrument panel on the driver's side, visible through the windscreen.

Depending on version, the VIN may be affixed to the cowl panel in the engine compartment above the windscreen washer fluid reservoir, visible with the bonnet open.

Engine number

Engine identifier code and engine number: stamped on the engine cylinder block.

Capacities and specifications

Engine data

Sales designation Engine identifier code	1.0 Petrol K 10 B	1.2 Petrol K 12 B	1.3 Diesel D 13 A
Number of cylinders	3	4	4
Bore dia. (mm)	73	73	69.6
Stroke (mm)	79.4	74.2	82.0
Piston displacement (cm ³)	996	1242	1248
Max. engine power (kW) at rpm	48 6000	63 5500	55 4000
Torque (Nm) at rpm	90 4800	114 4400	190 1750
Compression ratio	11.0	11.0	17.6
Cetane requirement (CN)	-	-	51 (D)
Octane requirement (RON) unleaded or unleaded	91 95	91 95	-
Engine oil consumption (l/1000 km)	1.0	1.0	1.0

Performance

(approx. km/h/mph)

Engine	K 10 B	K 12 B	D 13 A
Maximum speed ¹⁾			
Manual transmission	160/99	175/109	165/103
Automatic transmission	-	170/106	-

¹⁾ The maximum speed indicated is achievable at kerb weight (without driver) plus 200 kg payload. Optional equipment could reduce the specified maximum speed of the vehicle.

Fuel consumption, CO₂ emission

(approx.)

Engine	K 10 B	K 12 B	D 13 A
Manual transmission/Automatic transmission			
Urban (l/100km)	5.9/ -	6.9/ 7.8	5.5/ -
Extra-urban (l/100km)	4.4/ -	4.7/ 4.9	4.0/ -
Total (l/100km)	5.0/ -	5.5/ 5.9	4.5/ -
CO ₂ (g/km)	120/-	131/142	120/-

12-5 Technical data

Capacities

(approx. in litres)

Engine	K 10 B	K 12 B	D 13 A
Engine coolant	4.4	4.5	5.9
Fuel tank	45	45	45
Engine oil with filter change	3.9	3.9	3.2
Engine oil between MIN and MAX on dipstick	1.0	1.0	1.0
Washer fluid reservoir for windscreen and rear window washer system	2.5	2.5	2.5

Dimensions

(approx.)

Overall length (mm)	3740
Width (mm)	1680
Overall height (mm)	1590
Wheelbase (mm)	2360
Turning circle diameter, kerb to kerb (m)	9.6

12-7 Technical data

Vehicle weights

(approx.)

Weights (kg), Kerb weights

Model	Engine	Manual transmission	Automatic transmission
Agila	K 10 B	975	-
	K 12 B	990	1040
	D 13 A	1085	-
Agila with optional equipment	K 10 B	1030	-
	K 12 B	1045	1065
	D 13 A	1150	-

Tyre pressures in kPa/bar

Engine	Tyres	Tyre pressure for load of up to 3 persons		ECO Tyre pressure for load of up to 3 persons		Tyre pressure for full load	
		Front	Rear	Front	Rear	Front	Rear
K 10 B, K 12 B,	165/70 R 14	230/2.3	230/2.3	-	-	250/2.5	280/2.8
	185/60 R 15	230/2.3	210/2.1	280/2.8	250/2.5	230/2.3	260/2.6
D 13 A	165/70 R 14	250/2.5	230/2.3	-	-	250/2.5	280/2.8
	185/60 R 15	250/2.5	210/2.1	280/2.8	250/2.5	250/2.5	260/2.6
All	T 125/70 R 15 (temporary spare)	420/4.2	420/4.2	-	-	420/4.2	420/4.2

Index

- A**
- ABS 9-9
 - Accessories 3-9, 4-5, 10-6
 - Accessory socket 5-4
 - Air conditioning system 8-1, 8-3
 - Air intake 8-6
 - Air recirculation 8-3
 - Air vents 8-4
 - Airbags 3-13
 - Alternator, see Charging system 5-9
 - Antifreeze 7-6, 10-30
 - Antifreeze protection 10-4, 11-6
 - Antifreeze protection 10-4, 10-5
 - Anti-knock quality of fuel 9-12
 - Octane number 12-3
 - Anti-theft locking system 2-6
 - Anti-theft protection 9-2
 - Ashtrays 5-5
 - Automatic transmission 9-3
 - Automatic mode 9-4
 - Engine braking assistance 9-4
 - Fault 9-5
 - Interruption of power supply ... 9-5
 - Kickdown 9-4
 - Rocking the vehicle 9-5
 - Selector lever 9-4
 - Transmission display 9-3
 - Automatic wiping 5-3
- B**
- Battery 10-6
 - Interruption of power supply ... 9-5
 - Before starting-off 9-2
 - Belt force limiters 3-6
 - Belt tensioners 3-6
 - Belts 3-5, 10-29
 - Bleeding, diesel fuel system 10-7
 - Bonnet 10-2
 - Boot, see Luggage compartment 3-3
 - Brake assist 9-10
 - Brake fluid 11-7
 - Brake system 9-9
 - Brakes 9-9
 - ABS 9-9
 - Brake assist 9-10
 - Brake fluid 10-6
 - Brake lamps 10-9
 - Foot brake 9-9
 - Parking brake 9-9
 - Bulb replacement 10-7
- C**
- Capacities 12-5
 - Care 10-29
 - Catalytic converter 9-8
 - Central locking system 2-3, 2-4
 - Centre high-mounted stoplamp (CHMSL)
 - Bulb replacement 10-10

- Changing the battery
 - Remote control2-2
- Changing tyre/wheel type 10-17
- Changing wheels 10-22
- Charging system5-9
- Chassis number, see Vehicle Identification Number12-1, 12-2
- Child restraint systems3-9
- Child safety locks2-4
- Cigarette lighter5-5
- Cleaning 10-30
- Climate controls8-1
- Clock5-3
- Clutch fluid 10-6
- Clutch operation9-2, 9-6
- Cold starts9-8
- Control indicators5-5
 - ABS5-9
 - Airbags5-9
 - Belt tensioners5-9
 - Brake system5-9
 - Charging system5-9
 - Diesel particle filter5-13, 9-7
 - Door ajar2-5, 5-12
 - Driver's seat belt3-7, 5-9
 - Electronic Stability Program5-10
 - Engine coolant temperature5-11
 - Engine electronics5-13
 - Engine oil change5-12, 5-14
 - Engine oil pressure5-11
 - ESP5-10, 9-11
 - Exhaust5-11
 - Exhaust emissions5-11
 - Front fog lamps5-12, 6-3
 - Fuel level5-7, 5-11, 5-13
 - Headlamp range adjustment5-12
 - High beam5-12, 6-2
 - Immobiliser2-7, 5-12
 - Passenger airbag status3-18
 - Power steering5-10
 - Preheating5-11
 - Rear fog lamp5-12, 6-3
 - Service transmission5-9, 9-5
 - Service vehicle soon5-12
 - Theft-deterrent2-7, 5-12
 - Traction Control Support System off5-10, 9-11
 - Turn signal lamps5-13
- Coolant10-4, 11-6
 - Coolant level10-4
 - Coolant temperature5-11
 - Cooling8-3
 - Cooling fan9-3, 9-7, 10-1
 - Correcting time5-3
- Corrosion protection 10-4, 10-31, 11-6
- Courtesy lamps6-4
 - Bulb replacement10-11
- Cup holders4-1
- Curtain airbags3-16
- D**
 - Dashboard - see Instrument panel1-5
 - Data12-1
 - Demisting and defrosting8-2
 - Diesel9-12
 - Diesel fuel system10-7
 - Diesel particle filter (DPF)5-13, 9-7
 - Dimensions12-6
 - Dipped beam6-2
 - Bulb replacement10-7
 - Display5-6, 5-7
 - Door locks10-30
 - Doors2-5, 5-12
 - Driver's airbag3-13
 - Driving abroad6-3
 - Driving hints9-1
- E**
 - Electric throttle body system5-11
 - Electrical system10-11
 - Electronic Stability Program9-10
 - Emissions9-13, 12-4
 - Engine braking assistance9-4
 - Engine code12-2, 12-3
 - Engine coolant temperature5-11
 - Engine data12-3

13-3 Index

- Engine oil 10-3, 11-6
Additives 11-6
Topping up 10-3, 11-6
Viscosity 11-6
Engine oil level and consumption 10-3
Engine oil life monitor 5-14
Engine oil pressure 5-11
Engine speed 5-6
Engine wash 10-32
Environmental protection 10-30
ESP (Electronic Stability Program) 9-10
Exhaust gases 9-8
Exhaust system 9-8
Exterior care 10-30
Exterior lamps 6-1
Exterior mirrors 2-8
- F**
Fan 8-2
Filling station
Capacities 12-5
Engine oil level 10-3
Fuel 9-12, 12-3
Opening the bonnet 10-2
Tyre pressure 12-8
Vehicle data 12-1
Windscreen washer system . 10-5
First aid kit 4-5
- Flat tyre 10-24
Foot brake 9-9
Front airbags 3-13
Front fog lamps 6-3
Bulb replacement 10-8
Front passenger's airbag 3-13
Deactivation 3-17
Front turn signal lamps
Bulb replacement 10-8
Fuel 9-12
Fuel consumption 9-13, 12-4
Fuel filler cap 9-13
Fuel gauge 5-7
Fuse extractor 10-12
Fuses 10-11
- G**
Gears 9-6
Generator, see Charging system 5-9
Glove box 4-1
Gross Vehicle Weight 9-12, 12-7
- H**
Hand brake, see Parking brake . 9-9
Hazard warning lamps 6-2
Head restraints 3-1
Headlamp flash 6-2
Headlamp range adjustment 6-1
Headlamps 6-1
Bulb replacement 10-7
Driving abroad 6-3
Front fog lamps 6-3
Warning chime 5-13
Heated exterior mirrors 8-5
Heated rear window 8-5
Heating 8-1
Exterior mirrors 8-5
Rear window 8-5
Height adjustment
Head restraints 3-1
Seat belts 3-8
Steering wheel 5-1
High beam 6-2
Bulb replacement 10-7
High-pressure cleaners 10-30, 10-31
Horn 5-2
- I**
Identification plate 12-1
Ignition switch 9-1
Ignition system 9-2
Immobiliser 2-7
Infotainment system 7-1
Instrument cluster 5-8
Instrument panel 1-5
Instruments 5-1
Interior care 10-29

- Interior lamps6-4
 Bulb replacement 10-11
 Interior mirror2-9
 Interior stowage4-1
 Interruption of power supply9-5
 Selector lever lock9-5
 ISOFIX3-11, 3-12
J
 Jack 10-25
K
 Key2-1
 Locking doors2-3
 Removing5-13
 Replacement2-1
 Starting9-1, 9-2
 Steering column lock9-1
 Kickdown9-4
L
 Lashing eyes4-3
 Leather trim10-29
 License plate lamps
 Bulb replacement10-9
 Light switch6-1
 Lighting6-1
 Driving abroad6-3
 Loading4-3, 12-7
 Locking doors2-3
 Locking from the inside2-4
 Locks10-30
 Luggage compartment2-5
 Bulb replacement10-9
 Cover4-5
 Lighting6-4
 Loading4-3, 12-7
 Under floor storage4-4
M
 Main beam, see high beam6-2
 Maintenance11-1
 Air conditioning8-4
 Antifreeze protection10-4
 Brake fluid10-6
 Brakes9-9
 Engine oil10-3
 Infotainment system7-10
 Tyre pressure10-16
 Tyres10-17
 Windscreen wipers10-5
 Manual transmission9-6
 Mirrors2-8, 2-9, 8-5
 Misted windows8-2
 Mobile telephones7-10
 Muffler, see Exhaust system9-8
N
 Neutral9-4, 9-6
O
 Octane numbers12-3
 Odometer5-6
 Display brightness5-6
 Oil10-3, 11-6
 Additives11-6
 Topping up10-3, 11-6
 Viscosity11-6
 Oil level and consumption10-3
 Oil life monitor5-14
 Oil pressure5-11
 Outside temperature5-4
P
 Paintwork damage10-31
 Parking9-2
 Parking brake9-9
 Parking lamps
 Bulb replacement10-8
 Payload12-7
 Pedals9-1
 Performance12-4
 Petrol9-12, 12-3
 Pollen filter8-6
 Power mirrors2-8
 Power outlet5-4
 Power steering5-10
 Power windows2-10
 Child safety system2-11
 Preheating5-11, 9-2
R
 Radio7-6
 Radio equipment (CB)7-10
 Radio remote control

13-5 Index

- Central locking system 2-1, 2-3
- RDS (Radio Data System) 7-7
- Rear fog lamp 6-3
 - Bulb replacement 10-9
- Rear lamps
 - Bulb replacement 10-9
- Rear seats 3-3
 - Folding seatbacks 3-3
 - Restoring rear seatbacks 3-5
- Rear window washer system 5-3, 10-5
 - Antifreeze protection 10-5
 - Capacities 12-5
 - Washer fluid reservoir 10-5
- Rear window wiper 5-3, 10-6
- Refuelling 9-12
 - Fuel filler cap 9-12
- Remote control
 - Central locking system 2-1, 2-3
 - Replacement keys 2-1
- Reversing lamps 6-3
 - Bulb replacement 10-9
- Ride control systems 9-10
- Roof rack 4-4, 4-6
- Running-in 9-1
 - Brakes 9-9
- S**
- Safeguard against unauthorised use 7-3, 9-1
- Safety 10-1
- Safety accessories 3-9, 4-5
- Safety locks 2-4
- Seat adjustment 3-2
- Seat belt reminder 5-9
- Seat belts 3-5, 10-29
 - Driver's seat belt reminder 3-7, 5-9
 - Height adjustment 3-8
- Seat height adjustment 3-3
- Seat position 3-2
- Seats 3-2
 - Adjustment 3-2
- Selector lever 9-4
- Self-help
 - Automatic transmission 9-5
 - Remote control 2-2
- Service 11-1
- Service interval display 5-14
- Service intervals 11-1, 11-2
 - Additional operations 11-5
 - Interim service 11-1
 - Main service 11-1
 - Severe operating conditions . 11-5
- Side airbags 3-15
- Sidemarkers lamps
 - Bulb replacement 10-10
- Spare keys 2-1
- Spare wheel 10-24
- Speedometer 5-5
- Starting the engine 9-2
- Steam-jet cleaners 10-30, 10-31
- Steering column lock 9-1
- Steering wheel adjustment 5-1
- Steering wheel remote control 5-1, 7-2
- Storage compartments 4-1
- Sun visors 2-11
- Sunglasses storage compartment 4-3
- T**
- Tachometer 5-6
- Tail lamps
 - Bulb replacement 10-9
- Tailgate 2-5
- Tank
 - Fuel gauge 5-7
- Technical data 12-1
- Telephone, see Mobile telephones 7-10
- Temperature 8-1
- Temporary spare wheel 10-24
- The first 1000 km 9-1
- Tightening torque 10-24
- Tools 10-25
- Top-Tether 3-11
- Towing 10-28, 10-29
- Traction Control Support System (TCSS) 9-11

- Transmission display5-7, 9-3
Trip computer5-14
Trip odometer5-6
Turn signal lamps6-2
 Bulb replacement10-8
Tyre chains10-17
Tyre condition10-17
Tyre pressure10-16, 12-8
Tyre repair kit10-18
- U**
Units of measure5-16
Unleaded fuel9-12, 12-3
- V**
Vehicle care10-1
Vehicle checks10-1
Vehicle dimensions12-6
Vehicle Identification
Number12-1, 12-2
Vehicle keys, see Key2-1
Vehicle tools10-25
Vehicle weights12-7
Ventilation8-1, 8-4
- W**
Warning chimes5-13
Warning triangle4-5
Washer fluid reservoir10-5
Washing the vehicle10-30
Weights12-7
Wheel condition10-17
Wheel covers10-17
Wheels, tyres10-15
Windows2-10, 8-5
 Demisting and defrosting8-2
Windscreen washer
system5-3, 10-5
 Antifreeze protection10-5
 Capacities12-5
 Washer fluid reservoir10-5
Windscreen wipers5-2, 10-5
Winter operation
 Coolant, antifreeze10-4
 Fuel for diesel engines9-12
 Heating8-1, 8-3
 Locks10-30
 Tyre chains10-17
Window demisting and
defrosting8-2
Winter tyres10-15