

ASTRA

Infotainment Manual



Contents

Navi 900 IntelliLink	5
R 4.0 IntelliLink	89
R300 BT	131
Phone holder	161



Navi 900 IntelliLink

Introduction	6
Basic operation	15
Radio	32
CD Player	37
External devices	40
Navigation	46
Speech recognition	65
Phone	70
Frequently asked questions	81
Index	84

Introduction

General information	6
Theft-deterrent feature	7
Control elements overview	8
Usage	12

General information

The Infotainment system provides you with state-of-the-art in-car infotainment.

Using the FM, AM or DAB radio functions, you can register a great number of stations on various favourites pages.

You can even register music tracks, telephone numbers, destination addresses or tone settings on the favourites pages.

The CD player will entertain you with audio CDs and MP3/WMA CDs.

You can connect external data storage devices to the Infotainment system as further audio sources; either via a cable or via Bluetooth®.

The navigation system with dynamic route planning will reliably guide you to your destination, and, if desired, automatically avoid traffic jams or other traffic problems.

In addition, the Infotainment system is equipped with a Phone portal that allows comfortable and safe use of your mobile phone in the vehicle.

Using the phone projection function, you can operate specific applications on your smartphone via the Infotainment system.

Via the shop application, you may download additional apps to the Infotainment system.

Optionally, the Infotainment system can be operated using controls on the steering wheel or via the speech recognition system.

The well-thought-out design of the control elements, the touch screen and the clear displays enable you to control the system easily and intuitively.

Note

This manual describes all options and features available for the various Infotainment systems. Certain descriptions, including those for display and menu functions, may not apply to your vehicle due to model variant, country specifications, special equipment or accessories.

Important information on operation and traffic safety

⚠ Warning

Drive safely at all times when using the Infotainment system.

If in doubt, stop the vehicle before operating the Infotainment system.

⚠ Warning

The usage of the navigation system does not release the driver from the responsibility for a correct, vigilant attitude in road traffic. The related traffic regulations must always be followed.

Only make entries (e.g. addresses) with the vehicle stationary.

If a navigation instruction contradicts traffic regulations, the traffic regulations always apply.

⚠ Warning

In some areas one-way streets and other roads and entrances (e.g. pedestrian zones) that you are not allowed to turn into are not marked on the map. In such areas the Infotainment system may issue a warning that must be accepted. Here you must pay particular attention to one-way streets, roads and entrances that you are not allowed to drive into.

Radio reception

Radio reception may be disrupted by static, noise, distortion or loss of reception due to:

- changes in distance from the transmitter
- multi-path reception due to reflection
- shadowing

Theft-deterrent feature

The Infotainment system is equipped with an electronic security system for the purpose of theft deterrence.

The Infotainment system therefore functions only in your vehicle and is worthless to a thief.

Control elements overview

Centre display with controls



1	⏻	12
	If switched off: short press: switch power on	
	If switched on: short press: mute system; long press: switch power off	
	Turn: adjust volume	
2	Display/touch screen	
3	Information on the OnStar module with Wi-Fi connectivity and on the hotspot connection to another device	
4	MEDIA	12
	Press: activate CD player or external device	
5	»	
	Radio: short press: skip to next station; long press: seek up	
		32
	CD player / External devices: short press: skip to next track; long press: fast forward	
		38

6	HOME	
	Press: display home screen	
7	MENU	
	Turn: mark screen buttons or menu items; scroll through a list of menu items; change a settings value	
	Press: select/activate a marked screen button or menu item; confirm set value; switch to a different settings option; open application-specific submenu (if available)	
8	BACK	
	Press: return to previous screen/menu	
9	«	
	Radio: short press: skip to previous station; long press: seek down	
		32
	CD player / External devices: short press: skip to previous track; long press: fast rewind	
		38

10	RADIO	32
	Press: activate radio or change waveband	

Steering wheel controls (Type 1)



- 1**  Short press: open OnStar menu if no phone connected 12
 or take phone call 70
 or dial last number in call list when phone menu displayed 73
 or switch between calls when calls are waiting 73
 Long press: activate speech recognition 65

- 2** SRC (Source) 12
 Press: select audio source 12
 Turn upwards/downwards: select next/previous preset radio station when radio active 32
 or select next/previous track/chapter/picture when external devices active 41
 or select next/previous entry in call list when phone portal active and call list open 73
 Turn upwards/downwards and hold: scroll quickly through the entries in the call list 73
- 3** +
 Press: increase volume
- 4** -
 Press: reduce volume
- 5**  Press: end/decline call 73

- or deactivate speech recognition 65
 or activate/deactivate mute function 12

Steering wheel controls (Type 2)



In the Driver Information Centre, infotainment related information and menus are shown.

The menus on the Driver Information Centre are operated via the buttons on the right-hand side of the steering wheel (see below).

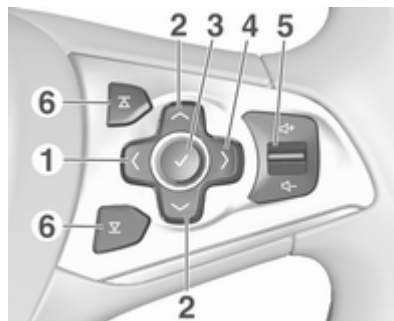

1 <

Press: display menu for application selection; return to next higher menu level on the Driver Information Centre

2 ✓ / ^

Short press: select menu item on the Driver Information Centre

Long press: fast-scroll through a long contacts list on the Driver Information Centre

3 ✓

Press: confirm selection on the Driver Information Centre

4 >

Press: display application-specific main menu on the Driver Information Centre

5 🔊 / 🔊 12

Press upwards: increase volume



Press downwards: decrease volume

6 🔊 / 🔊

Radio: press to select next / previous favourite on the Driver Information Centre 19

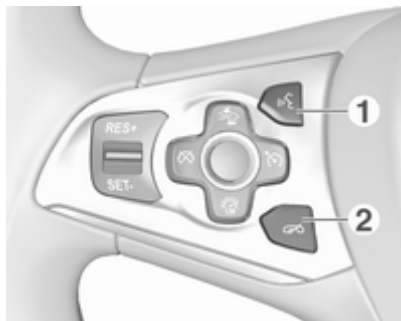
Media: press to select next / previous track on the Driver Information Centre 41



- 1 
 - Short press: take phone call . 73
 - or activate speech recognition 65
 - or interrupt a prompt and speak directly 65
 - or open OnStar menu if no phone connected 12
 - Long press: activate voice pass-thru (if supported by phone) 65
- 2 
 - Press: end/decline call 73

- or deactivate speech recognition 65
- or activate/deactivate mute function 12

For a description of all other controls, see Owner's Manual.

Usage

Switching Infotainment system on/off

Press  briefly. After switching on, the last selected Infotainment source becomes active.

Automatic switch-off

If the Infotainment system is switched on by pressing  while the ignition is switched off, it switches off again automatically after 10 minutes.

Setting the volume

Turn .

The current setting is shown on the display.

When the Infotainment system is switched on, the last selected volume is set, provided that the volume is lower than the maximum start-up volume  27.

Auto volume

When Auto volume is activated ⇨ 27, the volume is adapted automatically to compensate for the road and wind noise while driving.

Mute

Briefly press **M** to mute the audio sources.

To cancel mute again: turn **M** or press it briefly.

Modes of operation

Radio

Repeatedly press **RADIO** to activate the radio mode or to change between the different wavebands.

For a detailed description of the radio functions ⇨ 32.

CD player

Repeatedly press **MEDIA** to activate the CD player.

For a detailed description of the CD player functions ⇨ 37.

External devices

Repeatedly press **MEDIA** to activate the playback mode for a connected external device.

For a detailed description on connecting and operating external devices ⇨ 40.

Navigation

Press **HOME** to display the home screen.

Select **NAV** to display the navigation map showing the area around the current location.

For a detailed description of the navigation functions ⇨ 46.

Phone

Before the phone portal can be used, a connection has to be established between the Infotainment system and the mobile phone.

For a detailed description of preparing and establishing a Bluetooth connection between the Infotainment system and a mobile phone ⇨ 70.

If the mobile phone is connected, press **HOME** and then select **PHONE** to display the main menu of the phone portal.

For a detailed description of mobile phone operation via the Infotainment system ⇨ 73.

Phone projection

To show specific apps of your smartphone on the Infotainment system, connect your smartphone.

Press **HOME** and then select **PROJECTION** to start the projection function.

Depending on the smartphone connected, a main menu with different selectable apps is displayed.

For a detailed description ⇨ 43.

App shop

To download additional apps to the Infotainment system, select **SHOP**.

For a detailed description ⇨ 43.

OnStar

To display a menu with the OnStar Wi-Fi settings, select **OnStar**.

For a detailed description, see
Owner's Manual.

Basic operation

Basic operation	15
Menu operation	17
Keyboards	18
Favourites	19
Contacts	23
Tone settings	27
Volume settings	27
System settings	28

Basic operation

The centre display has a touch-sensitive surface that allows direct interaction with the screen.

↩ screen button

To return to the next higher menu level, select ↩.

Exit screen button

To leave the menu currently active, select **Exit**.

Selecting or activating a screen button or menu item

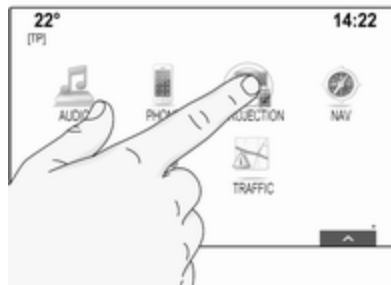

Touch a screen button or menu item. The corresponding system function is activated, a message is shown, or a submenu with further options is displayed.

Note

In subsequent chapters, the operating steps for selecting and activating a screen button or menu item via the touch screen will be described as "...select <button name>/<item name>".

Moving items



Touch and hold the element you wish to move until frame marks appear around the icons. Move your finger to the desired location and release the element.

Note

Constant pressure must be applied and the finger must be moved at a constant speed.

All other items are rearranged.

Press **HOME** on the control panel to exit edit mode.

Note

In subsequent chapters, the operating steps for moving a screen element via the touch screen will be described as "...drag the...icon to..." or "...drag the...menu item to...".

Scrolling lists



If there are more items available than presentable on the screen, the list must be scrolled.

To scroll through a list of menu items, you may:

- Place your finger anywhere on the screen and move it upwards or downwards.

Note

Constant pressure must be applied and the finger must be moved at a constant speed.

- Touch **∨** or **∧** at the top or bottom of the scroll bar.

- Move the slider of the scroll bar up and down with your finger.
- In alphabetically ordered lists, touch the respective letter in the vertical keyboard. The list jumps to the corresponding location within the list.

To return to the top of the list, touch the list title.

Note

In subsequent chapters, the operating steps for scrolling to a list item via the touch screen will be described as "...scroll to <item name>".

Menu operation

Home screen



The home screen is shown on the centre display.

All applications installed may be accessed from the home screen.

To personalise the home screen, drag the icon you wish to move to its new position. Release the icon to drop it in the respective location. Press **HOME** on the control panel to exit edit mode.

Note

If there is a second home page available, the icons can be placed on both pages. Drag the icon to the right edge of the display to scroll to the next page.

Application tray



The application tray is located in the top centre of the screen and is accessible from all main menus.

Three to five application icons may be stored in the application tray.

Some application icons dynamically adapt to the current situation, e.g. indicating that you missed a phone call.

The application tray can be personalised by moving items into and out of the application tray area.

Interaction selector bar

The interaction selector bar is located at the bottom of the screen and is accessible from all main menus.



Using the interaction selector bar, you may change the different views within one application or perform application-specific actions, e.g. start a speech recognition session.

To display the interaction selector bar when it is not shown on the display, select  at the bottom of the screen.

Messages

In the case of a system event, before the execution of a system function, or due to an outside trigger, e.g. incoming phone call, you may be prompted with a message.

Select one of the available options.

If ignored, most of the messages are dismissed automatically after a certain period of time. Alerts that are not dismissed automatically remain on the screen until they are acknowledged or the trigger becomes invalid.

Keyboards

Keyboard

Letter keyboard:



Symbol keyboard:



Depending on the application or function currently active, the keyboard menu is displayed differently.

To switch to the symbol keyboard, select **Sym**.

To switch to the letter keyboard, select **ABC**.

Entering characters

To enter a character, touch the respective screen button. The character is entered upon release.

Touch and hold a letter screen button to display associated letters in a letter pop-up menu. Release and then select the desired letter.



To confirm your input, select the respective confirmation screen button.

Autocomplete function

If a character sequence has been entered once, it is stored within the system and may be recalled by the autocomplete function.

As soon as one character (letter or digit) is entered, the autocomplete function becomes active. Every additional character entered is considered in the matching process, reducing the list of autocomplete matches.

Select **✓** next to the characters entered to display a list of all autocomplete matches.

Note

Above the **✓** screen button, the number of available options is displayed. It changes according to the number of matches found.

Select the respective list item. The keyboard is redisplayed with the respective list entry shown in the entry field.

Editing text

To place the cursor, touch the respective position within the text. Enter your changes.

Depending on the application, select **X** to delete one entered character. Touch and hold **X** to delete all characters.

Select the respective confirmation screen button to confirm an input.

Mixed case characters

In most cases, only capital letters may be entered.

If mixed case character recognition is available, an additional **Shift** screen button is displayed.

To activate the shift function and capitalise one letter, select **Shift**.

The function is automatically deactivated after one letter has been entered.

Keypad

If only a number or PIN code have to be entered, a keypad is displayed. Depending on the application or function currently active, the keypad menu is displayed differently.

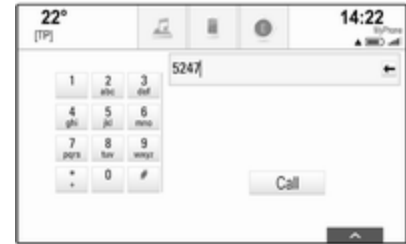

For a detailed description of how to enter characters and change entered text, see above.

Favourites

A range of different information may be stored as favourites, e.g.:

- radio stations
- music tracks

- albums or artists
- telephone numbers
- destinations and routes
- POIs
- contact entries
- tone settings
- home screen applications



60 individual favourite locations are available, displayed as five favourites per row.

They can be displayed in a one-row view or in a three-row view.

If a favourite location is occupied, the favourite screen button displays the label text of the respective favourite. If a favourite location is empty, the position number of the favourite location (1 to 60) is indicated.

Displaying favourites

The favourites list is accessible from all menus.

To display one row of favourites when no interaction selector bar is shown at the bottom of the screen:

Select .

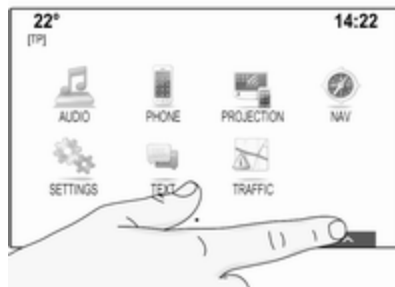

To display one row of favourites when an interaction selector bar is shown on the screen:

Place your finger on the interaction selector bar and move it upwards until one row of favourites becomes visible.

Note

Constant pressure must be applied and the finger must be moved at constant speed.



To display three rows of favourites, drag the favourites list up further.

Scrolling through favourites pages

The favourites page is visible in the one row or the three row view. To scroll through the favourites pages, place your finger anywhere on the favourites page and move it left or right.

The next or previous page of favourites is displayed.

Note

Constant pressure must be applied and the finger must be moved at constant speed.

When reaching the beginning or the end of the favourites pages, the whole list is wrapped.

Note

At the bottom of the screen, indication marks designate how many favourites pages may be accessed and which page is currently displayed. The number of indication marks adapts to the view chosen (more pages in one-row view, less pages in three-row view).

Storing favourites

Favourites may be stored from the home screen, the audio application, the navigation application or the phone application.

Reveal the favourites list and scroll to the respective favourites page.

Touch and hold the respective favourite screen button.

If there is only one storable item on the screen, a beeping sound is given out and the item is stored to the respective screen button.

If there is more than one storable item on the screen, the favourites page is minimised and the previously shown menu is redisplayed. Select the item you wish to store as a favourite. A beeping sound is given out and the item is stored to the respective screen button.

A few examples for storing favourites are given below.

Example: Radio station

Repeatedly press **RADIO** to activate the radio function and the desired waveband.

Seek for the station you wish to store as a favourite ⇨ 32.

To store this station as a favourite, reveal the favourites list and scroll to the respective favourites page.

Touch and hold the respective favourite screen button until a beep sounds. The station is stored as a favourite.

Example: Album

Repeatedly press **MEDIA** and select the desired audio source.

Select **BROWSE** to activate the browse menu and then select **ALBUMS** ⇨ 41.

To store one of the albums as a favourite, reveal the favourites list and scroll to the respective favourites page.

Touch and hold the respective favourite screen button. The favourites page is minimised and the list of albums is redisplayed.

Select the album you wish to store as a favourite. The selected album is stored as a favourite.

Example: Destination

Press **HOME** to display the home screen and then select **NAV**.

Select **DESTINATION**, select **RECENT** in the interaction selector bar and then touch the desired destination from the list ⇨ 53.

To store the address as a favourite, reveal the favourites list and scroll to the respective favourites page.

Touch and hold the respective favourite screen button. The selected address is stored as a favourite.

Example: Telephone number

Press **HOME** to display the home screen and then select **PHONE**.

Select **KEYPAD** and enter the number you wish to call ⇨ 73.

To store this number as a favourite, reveal the favourites list and scroll to the respective favourites page.

Touch and hold the respective favourite screen button. The number is stored as a favourite.

Retrieving favourites

Display a favourites page (see above) and scroll to the desired favourites page (if necessary).

Note

Unavailable favourites are greyed out.

Select the respective favourite screen button. Depending on the kind of favourite selected, a radio station or track is played, a phone call is initiated, a route is calculated or an application is started.

Note

The active favourite is highlighted.

Using the right-hand steering wheel remote control

Repeatedly press **Δ** or **∇** to select the desired audio favourite.

Alternatively, press **<** to display the cluster menu for application selection. Select **Audio** and then **Favourites**. Select the desired favourite.

Editing favourites

Select **SETTINGS** on the home screen, **Radio** and then **Manage Favourites**. A three-row view of the favourites list is displayed with the editing options shown in the interaction selector bar.

**Renaming favourites**

Scroll to the respective favourites page.

Select the favourite you wish to edit. Select **RENAME**.

A keyboard opens up with the current favourite label text displayed in the entry field as well as in the label preview area.

Enter the new label text and select **Save**. You are returned to the favourites page.

Select **^** at the bottom of the screen to reveal the interaction selector bar and then select **DONE** to return to the settings menu.

Deleting favourites

Scroll to the respective favourites page.

Select the favourite you wish to delete.

Select **DELETE**. The favourite and all associated data are deleted.

Select **DONE** to return to the settings menu.

Moving favourites

Scroll to the respective favourites page.

Drag the favourite you wish to move to its new position.

To store a favourite in a location beyond the favourites page currently visible, drag it to the < or > symbols on top of the favourites page. The list starts scrolling. To stop scrolling, navigate back to the favourites page area.

Select **DONE** to confirm the action and return to the settings menu.

Defining the number of favourites shown

Press **HOME** and then select **SETTINGS**. Select **Radio** and then **Number of Favourites Shown**.



Activate the desired number of favourites to be displayed.

Note

If the number of favourites stored exceeds the number of favourites activated in the settings menu, the additionally stored favourites are not deleted but just hidden from the view. They may be reactivated by increasing the number of viewable favourites.

Contacts

Two different types of contacts lists may be accessed from the Infotainment system:

- contacts lists downloaded from Bluetooth devices or other external sources
- vehicle contacts list

Note

A maximum of 1000 contacts may be stored in the vehicle contacts list. There is no limit for downloaded contacts lists.

The contacts list displayed upon first access differs depending on the application active and the devices connected.

Changing the source

To display a contacts list, press **HOME**, activate the phone or navigation application and then select **CONTACTS** in the interaction selector bar.

Select **Change Contacts List** on the right side of the screen. A list of all contact sources available is displayed. The currently active contacts list is marked with ✓.

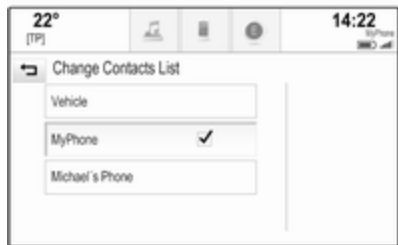

Select the desired contacts list. The respective list is displayed.

Note

The system remembers a list chosen within an application. When re-entering the contacts list from this application, the list previously selected is redisplayed.

Using the contacts list

To display a contacts list, press **HOME**, activate the phone or navigation application and then select **CONTACTS** in the interaction selector bar.

Navigation application:



Phone application:



To display the contact details view, select one of the entries from the list.

The contact details view may comprise:

- first name and last name
- several phone numbers
- several email addresses
- several addresses (e.g. home and work)
- in the vehicle contacts list: category entry

- in the vehicle contacts list: notes field
- for POI entries: information on business hours, menu (e.g. restaurant), prices etc.

Note

The data is ordered depending on the application active, e.g. in the phone application, the phone numbers are displayed first.

Select the desired entry.

Adding new contacts

To add information from the application menus to the vehicle contacts list, open the respective application.

Navigation application: Select or enter a destination ↷ 53. The destination details view is displayed. Select **Save**. A menu is displayed.

Phone application: Select **RECENT**. Select + beside the phone number you wish to add to the contacts list. A menu is displayed.



Select one of the options.

Create New Contact

A data category selection menu is displayed.

Select the respective data category for the information you wish to store, e.g. work address or mobile phone. The contact details view is displayed.

Note

The data categories presented in the new menu correspond to the information you wish to store, e.g. if the information to be stored is an address, only address types are presented in the list.

Complete the entry and select **Save** to save the contact.

Add to Existing Contact

The vehicle contacts list is displayed. Select the desired contact.

The contact details view is displayed with the information to be added shown separately on the right side of the screen.

Select the respective data category for the information you wish to store, e.g. work address or mobile phone.

If you choose an existing data category, the existing information is overwritten.

Select **Save** to save the new information.

Editing contacts

To edit a contact, open the vehicle contact list. Select the desired contact entry in the vehicle contacts list.

Select **Edit Contact** on the right side of the screen.



The editing view is displayed.

Modifying information

Select the field you wish to modify. Depending on the field selected, the keyboard or keypad is displayed.

Enter your changes ↵ 18.

Select **Save** in the contact details view to save your changes.

Adding new information

Select the field where you wish to enter additional information.

If you wish to create a new field for a data category already existing, e.g. a second mobile phone number, select + in the respective data field.

Note

The + screen button is only displayed if it is possible to add more information for that data category.

Depending on the field selected, the keyboard or keypad is displayed ↵ 18.

Enter the new data and select the screen button in front of the entry field.

Select **Save** in the contact details view to save your changes.

Deleting contacts

Deleting a single contact

To delete a single contact, open the vehicle contact list. Select the desired contact entry in the vehicle contacts list.

Select **Edit Contact** on the right side of the screen.

To delete the contact entry and all associated information, select **Delete**. A confirmation message is displayed.

Confirm the message. The entry is deleted.

Delete the whole vehicle contacts list

To delete the whole vehicle contacts list, open the vehicle contacts list.

Select **Change Contacts List** on the right side of the screen. A list of all available contacts sources is displayed. The currently active contacts list is marked with ✓.

Select the – screen button next to **Vehicle**. A confirmation message is displayed.

Confirm the message to delete the list.

Sorting the contacts lists

By default, the lists are ordered alphabetically by first name. If there is no first name available, the last name is taken instead. If there is no first or last name, one of the first characters entered is used as sorting criteria.

The sorting order may be changed, if first name and last name are stored in two different fields.

To change the sorting order, select **Sort**.

Choose the desired sorting order. The list is resorted accordingly.

Tone settings

In the tone settings menu, the tone characteristics can be set. The menu may be accessed from each audio main menu.

Note

A customised set of tone settings may be stored as a favourite. For a detailed description ⇨ 19.

To open the tone settings menu, select **MENU** in the respective audio main menu. Select **Tone Settings**.

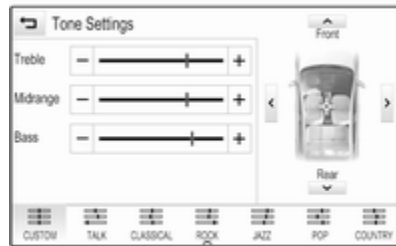

Treble

Use this setting to enhance or attenuate the high frequencies of the audio sources.

Adjust the setting by repeatedly touching – or +.

Alternatively, move the slider on the settings bar.

Midrange

Use this setting to enhance or attenuate the midrange frequencies of the audio source.

Adjust the settings by repeatedly touching – or +.

Alternatively, move the slider on the settings bar.

Bass

Use this setting to enhance or attenuate the deep frequencies of the audio sources.

Adjust the settings by repeatedly touching – or +.

Alternatively, move the slider on the settings bar.

Balance and fader

In the illustration at the right side of the menu, define the point within the passenger compartment which is to have the best sound.

To adjust the settings, touch ^, v, < and >.

To quickly change between the front and rear speakers, select **Front** or **Rear** at the top and bottom of the vehicle diagram.

Equalizer modes

Select one of the screen buttons in the interaction selector bar to optimise the tone for the specific styles of music.

Select **CUSTOM** if you wish to define the tone settings yourself.

Volume settings

Maximum startup volume

Press **HOME** and then select **SETTINGS** on the home screen.

Scroll through the list and select **Radio** and then **Maximum Start-Up Volume**.

Touch – or + to set the desired volume.

Automatic volume adjustment

Press **HOME** and then select **SETTINGS**.

Scroll through the list and select **Radio** and then **Auto Volume**.

To adjust the degree of volume adaptation, set **Auto Volume** to one of the available options.

Off: no enhancement of volume with increasing vehicle speed.

High: maximum enhancement of volume with increasing vehicle speed.

Volume of traffic announcements

To adjust the volume of traffic announcements, set the desired volume while a traffic announcement is given out by the system. The respective setting is then stored by the system.

System settings

Various settings and adaptations for the Infotainment system can be made via the **SETTINGS** application.



Time and Date

Press **HOME** and then select **SETTINGS**.

Select **Time and Date**.

Set time

Select **Set Time** to enter the respective submenu.



Select **Auto Set** at the bottom of the screen. Activate either **On - RDS** or **Off - Manual**.

If **Off - Manual** is selected, adjust hours and minutes by touching **^** or **∨**.

Touch **12-24 Hr** on the right side of the screen to select a time mode.

If 12-hour mode is selected, a third column for AM and PM setting is displayed. Select the desired option.

Set date

Select **Set Date** to enter the respective submenu.

Note

If date information is automatically provided, this menu item is not available.

Select **Auto Set** at the bottom of the screen. Activate either **On - RDS** or **Off - Manual**.

If **Off - Manual** is selected, adjust the date by touching \wedge or \vee .

Clock display

Select **Clock Display** to enter the respective submenu.

To turn off the digital clock display in the menus, select **Off**.

Language

Press **HOME** and then select **SETTINGS**.

Scroll through the list and select **Language**.

Note

The language currently active is marked with \checkmark .

Scroll through the list and select the desired language.

Valet mode

If valet mode is activated, all vehicle displays are locked and no changes may be performed within the system.

Note

Vehicle-related messages and the rear view camera remain enabled.

Locking the system

Press **HOME** and then select **SETTINGS**.

Scroll through the list and select **Valet Mode**. A keypad is displayed.



Enter a four-digit code and select **Enter**. The keypad is redisplayed.

To confirm the first input, re-enter the four-digit code and select **Lock**. The system is locked.

Unlocking the system

Turn the Infotainment system on. A keypad is displayed.



Enter the respective four-digit code and select **Unlock**. The system is unlocked.

Forgotten PIN Code

To reset the PIN code to the default setting, contact your workshop.

Display

Press **HOME** and then select **SETTINGS**.

Scroll through the list and select **Display**.

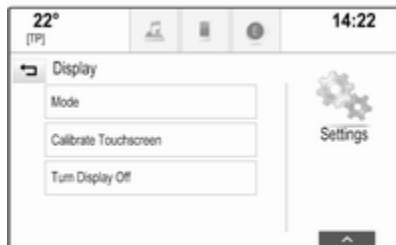

Mode

Select **Mode** to enter the respective submenu.

Depending on the external lighting conditions, select **Day** or **Night**.

If you select **Auto**, the system automatically adjusts the display.

Calibrate Touchscreen

Select **Calibrate Touchscreen** to enter the respective submenu.



Follow the instructions on the screen, touching the respective points indicated. The touch screen is calibrated.

Turn Display Off

Select **Turn Display Off** to turn off the display.

To turn the display back on, touch the touch screen or press a button on the control panel.

Return to Factory Settings

Press **HOME** and then select **SETTINGS**.

Scroll through the list and select **Return to Factory Settings**.

Restore Vehicle Settings

Select **Restore Vehicle Settings** to restore all vehicle personalisation settings. A warning message is displayed.

Select **Restore**. The settings are reset.

Clear All Private Data

Select **Clear All Private Data** to delete the following data:

- paired Bluetooth devices
- stored phone books
- vehicle contacts list
- destination lists
- favourites

A warning message is displayed.

Select **Delete**. The data is deleted.

Restore Radio Settings

Select **Restore Radio Settings** to reset the following data:

- tone settings
- volume settings
- speech settings
- application tray
- contacts sources

A warning message is displayed.

Select **Restore**. The settings are reset.

Software Information

Press **HOME** and select **SETTINGS**.

Scroll through the list and select **Software Information**.



A list of version numbers of all items loaded to the system is displayed.

System update

To update your system software, contact your workshop.

Radio

Usage	32
Station search	32
Radio data system (RDS)	33
Digital audio broadcasting	35

Usage

The radio function is part of the **AUDIO** application.



Activating the radio function

Select **AUDIO** on the home screen and then select **RADIO** in the interaction selector bar.

Alternatively, press **RADIO** on the control panel.

Selecting the waveband

Repeatedly select or press **RADIO** to toggle between the different wavebands.

Station search

Automatic station search

Press \ll or \gg to play the previous or next station.

Manual station search

Press and hold \ll or \gg . Release the respective button when the desired frequency has almost been reached.

Station tuning

Select **TUNE** in the interaction selector bar. A keypad is displayed.



Touch the **Direct Tune** field and then enter the desired frequency. Confirm your input.

Station lists

In the station lists, all receivable radio stations within the current reception area are available for selection.

To display the station list of the waveband currently active, you may optionally:

- Touch the screen.
- Select **BROWSE** in the interaction selector bar.
- Turn **MENU**.

The station list is displayed.



Note

The currently received station is highlighted.

Scroll through the list and select the desired list item.

Category lists

Numerous RDS ⇨ 33 and DAB ⇨ 35 stations broadcast a PTY code, which specifies the type of programme transmitted (e.g. news). Some stations also change the PTY code depending on the content which is currently transmitted.

The Infotainment system stores these stations, sorted by programme type in the corresponding category list.

Note

The **Categories** list item is only available for the FM and the DAB wavebands.

Select **MENU** in the interaction selector bar to display the respective waveband menu and select **Categories**.

A list of programme type categories currently available is displayed.

Select the desired category. A list of stations is displayed transmitting a programme of the selected type.

Select the desired station.

Updating the station list

If the stations stored in a waveband-specific station list can no longer be received, select **Update Station List**.

Note

If a waveband-specific station list is updated, the corresponding category list is also updated.

Updating Station List is displayed on the screen until the search has been completed.

Radio data system (RDS)

RDS is a service of FM stations that considerably improves the finding of the desired station and its fault-free reception.

Advantages of RDS

- On the display, the programme name of the station appears instead of its frequency.
- During a station search, the Infotainment system tunes in to RDS stations only.
- The Infotainment system always tunes into the best receivable broadcasting frequency of the set station by means of AF (alternative frequency).
- Depending on the station received, the Infotainment system displays radio text that can contain e.g. information on the current programme.

RDS settings

To configure the RDS settings options, activate the radio function and then select the FM waveband. Select **MENU** in the interaction selector bar to display the FM menu.



RDS

Set **RDS - On** or **RDS - Off**.

Traffic Programme (TP)

Radio traffic service stations are RDS stations that broadcast traffic news. If the traffic service is switched on, the function currently active is interrupted for the duration of the traffic announcement.

If the radio traffic service is activated, **[TP]** is shown in the top line of all main menus. If the current station or media played is not a radio traffic service station, **[]** is displayed and a search is started automatically for the next radio traffic service station available.

As soon as a radio traffic service station is found, **[TP]** is highlighted. If no radio traffic service station is found, **[]** remains on the screen.

If a traffic announcement is broadcast on the respective radio traffic service station, a message is displayed.

To interrupt the announcement and return to the function previously activated, dismiss the alert.

Set **Traffic Programme (TP) - On** or **Traffic Programme (TP) - Off**.

Region

Sometimes RDS stations broadcast regionally different programmes on different frequencies.

If regionalisation is switched on, alternative frequencies with the same regional programmes are selected if necessary. If regionalisation is switched off, alternative frequencies of the stations are selected without regard to regional programmes.

Set **Region - On** or **Region - Off**.

Digital audio broadcasting

DAB broadcasts radio stations digitally.

Advantages of DAB

- DAB stations are indicated by the programme name instead of the broadcasting frequency.
 - With DAB, several radio programmes (services) can be broadcast on a single ensemble.
 - Besides high-quality digital audio services, DAB is also able to transmit programme-associated data and a multitude of other data services including travel and traffic information.
 - As long as a given DAB receiver can pick up the signal sent out by a broadcasting station (even if the signal is very weak), sound reproduction is ensured.
 - In the event of poor reception, the volume is reduced automatically to avoid the output of disagreeable noises.
If the DAB signal is too weak to be picked up by the receiver,
- reception is interrupted completely. This can be avoided by activating **DAB to DAB Linking** and/or **DAB to FM Linking** in the DAB menu (see below).
 - Interference caused by stations that are on nearby frequencies (a phenomenon that is typical of AM and FM reception) does not occur with DAB.
 - If the DAB signal is reflected by natural obstacles or buildings, the reception quality of DAB is improved, whereas AM or FM reception is considerably impaired in such cases.
 - When DAB reception is enabled, the FM tuner of the Infotainment system remains active in the background and continually searches for the best receivable FM stations. If TP ↷ 33 is activated, traffic announcements of the FM station with the best reception are issued. Deactivate TP if you do not wish DAB reception to be interrupted by FM traffic announcements.

DAB settings

To configure the DAB settings options, activate the radio function and then select the DAB waveband. Select **MENU** in the interaction selector bar to display the DAB menu.



DAB announcements

Besides their music programmes, many DAB stations also broadcast announcements of various categories. If you activate some or all categories, the DAB service currently received is interrupted when an announcement of these categories is made.

Select **DAB Announcements** to display the DAB categories list.

Select the desired categories. The categories selected are marked with **✓**.

Note

DAB announcements can only be received if the DAB waveband is activated.

DAB to DAB Linking

If this function is activated, the device switches over to the same service (programme) on another DAB ensemble (if available) when the DAB signal is too weak to be picked up by the receiver.

Set **DAB to DAB Linking - On** or **DAB to DAB Linking - Off**.

DAB to FM Linking

If this function is activated, the device switches over to a corresponding FM station of the active DAB service (if available) when the DAB signal is too weak to be picked up by the receiver.

Set **DAB to FM Linking - On** or **DAB to FM Linking - Off**.

L Band

If **L Band** is activated, the Infotainment system receives an additional frequency range. The frequencies for L-band comprise earth and satellite radio (1452 - 1492 MHz).

Set **L Band - On** or **L Band - Off**.

Intellitext

The **Intellitext** function allows for the reception of additional information such as announcements, financial information, sports, news etc.

Select one of the categories and choose a specific item to display detailed information.

CD Player

General information	37
Usage	38

General information

A CD player for the playback of audio CDs and MP3/WMA CDs is located in the glovebox.

Caution

Under no circumstances place DVDs, single-CDs with a diameter of 8 cm or shaped CDs in the audio player.

You must not put any stickers on CDs. These discs can get jammed in the CD drive and ruin the player. Replacement of the device will then be necessary.

Important information about audio CDs and MP3/WMA CDs

- The following CD formats can be used:
CD, CD-R and CD-RW
- The following file formats can be used:
ISO9660 Level 1, Level 2,
Romeo, Joliet

MP3 and WMA files written in any format other than listed above may not play correctly, and their file names and folder names may not be displayed correctly.

- Audio CDs with copy protection, which are not in compliance with the audio CD standard, may not play correctly or not at all.
- Self-recorded CD-Rs and CD-RWs are more vulnerable to mishandling than prerecorded CDs. Correct handling, especially in the case of self-recorded CD-Rs and CD-RWs, must be ensured.
- Self-recorded CD-Rs and CD-RWs may not play correctly or not at all.
- On mixed mode CDs (combinations of audio and data, e.g. MP3), only the audio tracks will be detected and played.
- Avoid leaving fingerprints when you change CDs.

- Put CDs back in their sleeves immediately after removing them from the audio player in order to protect them from damage and dirt.
- Dirt and liquids on CDs can smear the lens of the audio player inside the device and cause faults.
- Protect CDs from heat and direct sunlight.
- The following restrictions apply for the data stored on an MP3/WMA CD:
Maximum file/song number: 800
Maximum folders in depth hierarchy: 8
WMA files with Digital Rights Management (DRM) from online music shops cannot be played.
WMA files can only be played safely if they were created with Windows Media Player version 9 or later.
Applicable playlist extensions: .m3u, .pls

Playlist entries must be in the form of relative paths.

Note

This chapter only deals with playing MP3 files since the operation for MP3 and WMA files is identical. When a CD with WMA files is loaded MP3 related menus are displayed.

Usage

Starting CD playback

Push an audio or MP3 CD with the labelled side facing upwards into the CD slot until it is pulled in.

Repeatedly select **MEDIA** in the interaction selector bar or press **MEDIA** on the control panel to activate the CD function.



Removing a CD

Press ▲. The CD is pushed out of the CD slot.

If the CD is not removed after ejection, it will be drawn back in after a few seconds.

Function buttons

Pausing CD playback

Select **II** to pause playback. The screen button changes to ►.

Select ► to resume playback.

Skipping to previous or next track

Select ◀◀ or ▶▶ to play the previous or next track.

Alternatively, turn **MENU** to skip to previous or next tracks.

Fast forwarding or rewinding

Touch and hold ◀◀ or ▶▶ to rewind or fast forward.

Alternatively, move the slider on the time bar.

Track list

To display the track list, you may optionally:

- Touch the screen.
- Select **BROWSE** in the interaction selector bar.
- Turn **MENU**.

The track list is displayed.

Note

The track currently playing is highlighted.

Scroll through the list and select the desired list item.

Note

For a detailed description of browsing MP3 CDs ↪ 41.

Playback order

Select **MENU** in the interaction selector bar to display the CD menu.

If **Shuffle** is set to **On**, all tracks on the active CD are played in random order.

Set **Shuffle - On** or **Shuffle - Off**.

External devices

General information	40
Playing audio	41
Playing movies	42
Using smartphone applications ...	43
Using apps	43

General information

A USB port for the connection of external devices is located in the centre console behind the parking brake or underneath the armrest.

Two USB ports for charging devices only are located at the rear of the centre console.

Note

The USB port must always be kept clean and dry.

USB port

An MP3 player, USB device or smartphone can be connected to the USB port.

The Infotainment system can play music files and movies contained in these devices.

When connected to the USB port, the devices mentioned above can be operated via the controls and menus of the Infotainment system.

Note

Not all auxiliary devices are supported by the Infotainment system. Check the compatibility list on our website.

Connecting/disconnecting a device

Connect the USB device to the USB port.

Note

If a non-readable USB device is connected, a corresponding error message appears and the Infotainment system automatically switches to the previous function.

To disconnect the USB device, select another function and then remove the USB storage device.

Caution

Avoid disconnecting the device during playback. This may damage the device or the Infotainment system.

Bluetooth

Devices which support the Bluetooth music profiles A2DP and AVRCP can be connected wirelessly to the Infotainment system. The Infotainment system can play music files contained in these devices.

Connecting/disconnecting a device

For a detailed description on the Bluetooth connection ↗ 71.

Bluetooth device management

To change the Bluetooth device connected, select **MENU** in the interaction selector bar.

Select **Manage Bluetooth Devices** to display the device list.

For a detailed description ↗ 71.

File formats

Only devices formatted in the FAT32, NTFS and HFS+ file systems are supported.

Note

Some files may not be played properly. This might be due to a different recording format or the condition of the file.

Files from online shops to which Digital Rights Management (DRM) has been applied cannot be played.

The Infotainment system can play the following audio and movie files stored on external devices.

Audio files

The playable audio file formats are MP3, WMA, AAC, M4A and AIF.

When playing a file with ID3 tag information, the Infotainment system can display information, e.g. on the track title and artist.

Movie files

The playable movie file formats are AVI, MPG, MP4, XVID and WMV.

Common audio and video combinations for mobile devices are generally supported.

Playing audio

Starting playback

If not connected, connect the device ↗ 40.

Repeatedly select **MEDIA** in the interaction selector bar or press **MEDIA** on the control panel to activate the desired media source.

Example: USB main menu.



Function buttons

Pausing playback

Select **II** to pause playback.

Select **▶** to resume playback.

Skipping to previous or next track

Select **◀◀** or **▶▶** to play the previous or next track.

Alternatively, turn **MENU** to skip to previous or next tracks.

Fast forwarding or rewinding

Touch and hold **◀◀** or **▶▶** to rewind or fast forward.

Alternatively, move the slider on the time bar (only available for USB).

Browse function

To display the browse screen, you may optionally:

- Touch the screen.
- Select **BROWSE** in the interaction selector bar.
- Turn **MENU**.



Select **PLAYLISTS**, **ARTISTS**, **ALBUMS**, **SONGS**, **GENRES** or **MORE**. **MORE** comprises the additional categories: **Folder View**, **Podcasts**, **Audiobooks**, **Videos** and **Composers**.

Browse through the categories until you find the desired track. Select the track to start playback.

Playback order

If **Shuffle** is activated, the tracks on the active device are played in random order.

Note

In USB playback, the shuffle function is dependent on the filter mode selected for song playback, e.g. album, artist, genre.

To display the respective audio menu, select **MENU** in the interaction selector bar.

Set **Shuffle - On** or **Shuffle - Off**.

Playing movies

Starting video playback

Connect the device ⇨ 40.

Repeatedly select **MEDIA** in the interaction selector bar or press **MEDIA** to activate the desired media source.

Select **BROWSE** and then **MORE**. Select **Videos** and then the desired movie file. Video playback is started.

Note

Videos may only be played if the parking brake is applied.



Function buttons

Pausing playback

Select **II** to pause playback.

Select **▶** to resume playback.

Skipping to previous or next file

Select **◀◀** or **▶▶** to play the previous or next movie file.

Alternatively, turn **MENU** to skip to previous or next movie files.

Fast forwarding or rewinding

Touch and hold ◀◀ or ▶▶ to rewind or fast forward.

Alternatively, move the slider on the time bar.

Video menu

To display the video menu, select **MENU** in the interaction selector bar.

Using smartphone applications

The phone projection applications Apple CarPlay™ and Android™ Auto display selected apps from your smartphone on the Infotainment screen and allow their operation directly via the Infotainment controls.

Check with the device's manufacturer if this function is compatible with your smartphone and if this application is available in the country you are in.

Preparing the smartphone

Android phone: Download the Android Auto app to your smartphone from the Google Play™ Store.

iPhone®: Make sure Siri® is activated on your smartphone.

Activating phone projection in the settings menu

Press  to display the home screen and then select **SETTINGS**.

Scroll through the list and select **Apple CarPlay** or **Android Auto** to display a submenu.

Make sure the respective application is activated.

To display a list of all devices registered for this function, select **Manage Devices**.

Connecting the mobile phone

Connect the smartphone to the USB port  40.

Starting phone projection

To start the phone projection function, press  and then select **PROJECTION**.

Note

If the application is recognised by the Infotainment system, the application icon may change to **Apple CarPlay** or **Android Auto**.

To start the function, you can alternatively press and hold  for a few seconds.

The phone projection screen displayed depends on your smartphone and software version.

Returning to the Infotainment screen

Press .

Using apps

Via the **SHOP** application, external apps can be downloaded to the Infotainment system.

User registration

When first starting the SHOP application, a user registration is required.

Press **HOME** and then select **SHOP**.

Follow the instructions on the screen:

1. Start the registration process.
2. Enter your first and last name.
3. Choose your country.
4. Accept the terms of use and privacy notice.

Note

To read the terms of use and/or the privacy notice, display the text on the screen or send it to your email account.

When the registration process is completed, the app shop main page is displayed.

Note

The apps in the app shop can only be downloaded if the Infotainment system is connected to the internet.

Internet connection

An internet connection is required either via the in-vehicle OnStar Wi-Fi hotspot or an external device, e.g. smartphone.

Press **HOME** and then select **SETTINGS**. Select **Wi-Fi** to display the Wi-Fi menu.

Make sure that **Wi-Fi** is activated and then select **Manage Wi-Fi Networks**.

Select **Add Other Network** to establish a new connection. Follow the instructions on the screen.

Downloading an app

Before the external apps can be used on the Infotainment system, they have to be downloaded.

Press **HOME** and then select **SHOP**. Choose the browse tab to gain access to all apps available for download. Select the desired app to display its main page and then start the download process.

Note

Apps which have been downloaded to the Infotainment system are also accessible via the home screen.

Starting an app

Press **HOME**, scroll the home screen pages, if required, and then select the downloaded app you want to start.



Note

Depending on the app downloaded, a registration might be required when first starting the app.

Deleting an app

Press **HOME** and then select **SHOP**.

To gain access to all downloaded apps, choose the tab for apps already downloaded. Select the desired app to display its main page and then start the deletion process.

The application is deleted from the Infotainment system.

Settings

Internet connection

Press **HOME** and then select **SHOP**. Choose the settings tab to display the settings menu and then select the networks menu item.

Activate the desired network.

Info

To display information on the app shop, press **HOME** and then select **SHOP**. Choose the settings tab to display the settings menu and then select the info menu item.

Terms of use and privacy notice

To display the terms of use or the privacy notice, press **HOME** and then select **SHOP**. Choose the settings tab. Select the desired menu item.

If desired, you can send the texts to your email account.

Select **E-Mail** on the bottom of the screen. Enter your email address and confirm your input. The respective text is forwarded to your email account.

Reset user

To delete all registration data entered, press **HOME** and then select **SHOP**. Choose the settings tab to display the settings menu and then reset all user-specific settings.

Navigation

General information	46
Usage	47
Destination input	53
Guidance	59

General information

The navigation system will reliably guide you to your destination.

The current traffic situation is taken into account in the route calculation. For this purpose, the Infotainment system receives traffic announcements in the current reception area via RDS-TMC.

The navigation system cannot, however, take into account traffic incidents, traffic regulations changed at short notice and hazards or problems that arise suddenly (e.g. road works).

Caution

The usage of the navigation system does not release the driver from the responsibility for a correct, vigilant attitude in road traffic. The relevant traffic regulations must always be followed. If a navigation instruction contradicts traffic regulations, the traffic regulations always apply.

Functioning of the navigation system

The position and movement of the vehicle are detected by the navigation system using sensors. The travelled distance is determined by the vehicle's speedometer signal, turning movements on bends by a gyro sensor. The position is determined by the GPS (Global Positioning System) satellites.

By comparing the sensor signals with the digital maps, it is possible to determine the position with an accuracy of approx. 10 metres.

The system will also work with poor GPS reception. However, the accuracy of the determination of the position will be reduced.

After the entry of the destination address or point of interest (nearest petrol station, hotel, etc.), the route is calculated from the current location to the destination selected.

Route guidance is provided by voice output and an arrow, as well as with the aid of a multi-colour map display.

Important information

TMC traffic information system and dynamic route guidance

The TMC traffic information system receives all current traffic information from TMC radio stations. This information is included in the calculation of the overall route. During this process, the route is planned so that traffic problems related to pre-selected criteria are avoided.

If there is a traffic problem during active route guidance, depending on the pre-settings, a message appears as to whether the route should be changed.

TMC traffic information is displayed in the map display as symbols or as detailed text on the TMC messages menu.

To be able to use TMC traffic information, the system must receive TMC stations in the relevant region.

The TMC traffic stations can be selected in the navigation menu
⇨ 47.

Map data

All required map data is stored within the Infotainment system. To update your map software via the USB port, contact your workshop.

Usage

To display the navigation map, press **HOME** and then select the **NAV** icon.

Route guidance not active



The current location is indicated by a circle with an arrow pointing into the direction of travel.

After a timeout of approx. 15 seconds, the application tray and the interaction selector bar disappear to show a full screen view of the map.



To redisplay the application tray and the interaction selector bar, touch the screen.

Route guidance active

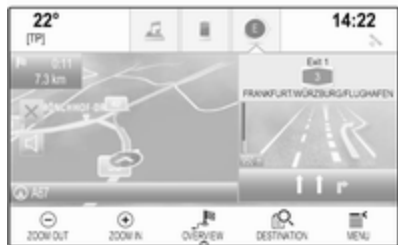

- The map view is displayed.
- The active route is indicated by a coloured line.
- The moving vehicle is marked by a circle.
- The next turning manoeuvre is indicated by an arrow symbol on the right side of the screen.
- Lane guidance is provided on the right side of the screen.

- The arrival time is shown above the arrow symbol.
- The distance to the next turning manoeuvre is shown below the arrow symbol.

Map manipulation

Scrolling

To scroll the map, place your finger anywhere on the screen and move it up, down, left or right depending on the direction in which you want to scroll.

The map moves accordingly displaying a new section.

To return to the current location, select **RESET** in the interaction selector bar.

Centring

Touch the desired location on the screen. The map centres around this location.

A red  is displayed at the respective location and the corresponding address is shown on a label.



To return to the current location, select **RESET** in the interaction selector bar.

Zooming

To zoom in on a selected map location, select **ZOOM IN**.

To zoom out and display a larger area around the selected location, select **ZOOM OUT**.

Overview button

During active route guidance, an **OVERVIEW** screen button is displayed in the interaction selector bar.

To display an overview of the route currently active on the map, select **OVERVIEW**.

The screen button changes to **RESET**.

To return to the normal view, select **RESET**.

Map display

View mode

Select **MENU** in the interaction selector bar and then select **Map View** to display the respective submenu.

Select the desired map view (**3D View**, **Heading Up View**, **North Up View**).

Note

Alternatively, you may repeatedly select  in the application tray to quickly toggle between the different map views (**3D View**, **Heading Up View**, **North Up View**).

Audio information

If **Audio Information - On** is set, information on the station, album or song currently playing is displayed on the map screen.

Select **MENU** in the interaction selector bar and then select **Map View** to display the respective submenu.

Set **Audio Information - On** or **Audio Information - Off**.

Display mode

Select **MENU** in the interaction selector bar and then select **Map View** to display the respective submenu.

Select **Day / Night Mode**.

Depending on the external lighting conditions, activate **Day** or **Night**.

If you wish the screen to adjust automatically, activate **Auto**.

Display of buildings

Select **MENU** in the interaction selector bar and then select **Map View** to display the respective submenu.

Buildings can be displayed in 3D or normal view.

Set **3D Buildings - On** or **3D Buildings - Off**.

Autozoom function

Select **MENU** in the interaction selector bar and then select **Map View** to display the respective submenu.

The system may zoom in on the map in case of special manoeuvres.

Set **Autozoom - On** or **Autozoom - Off**.

POI icons

Select **MENU** in the interaction selector bar and then select **Display "Points of Interest" Icons** to display the respective submenu.

If **POI Icons** is activated, points of interest around the current location or along the route are displayed on the map.

Set **POI Icons - On** or **POI Icons - Off**.

If **POI Icons** is set to **On**, activate the POI categories you wish to be displayed.

Select **Clear All** to deselect all categories.

Information on the current location

Select **MENU** in the interaction selector bar to display the navigation menu.



Select **Current Location** to display the respective submenu indicating details on the nearest address, the coordinates, and Points of interest (↪ 53) around the current location.



Nearest address

From this submenu, you may store the nearest address to the system.

Select **Nearest Address:** to display the destination details view.

For a detailed description on how to save an address

- as or to a contact ↪ 23
- as a favourite ↪ 19

Points of interest

From this submenu, you may start route guidance to one of the nearest points of interest.

Select the desired point of interest. The destination details view is displayed.

Select **Go**.

For a detailed description on how to enter a destination ↪ 53.

Navigation data management

Select **MENU** in the interaction selector bar and then select **Personal Data**.

A list of different data storage locations of the navigation application is displayed.

Contacts list

Select **Contacts** to display the respective submenu.

To delete all entries in the contacts list, select **Delete All Entries**. Confirm the message displayed to delete the entire contacts list.

To display the contacts edit mode, select **Edit Contacts List**.

For a detailed description on editing the contacts list ↪ 23.

Recent destinations list

Select **Recent Destinations** to display the respective submenu.

To delete all entries in the recent destinations list, select **Delete All Destinations**. Confirm the message displayed to delete the entire recent destinations list.

To delete individual destinations, select **Delete Individual Destinations**. The recent destinations list is displayed. Select – next to the respective destination. Confirm the message displayed to delete the destination.

Downloaded POIs

Select **My POIs** to display the respective submenu.

POIs which were previously downloaded to the system may be deleted. The other POIs remain within the system.

To delete all entries in the contacts list, select **Delete All My POIs**. Confirm the message displayed to delete the entire POIs list.

To delete only individual categories, select **Delete Individual Categories** to display a list of POI categories. Select – next to the respective category. Confirm the message displayed to delete the category.

Uploading destination data to a USB device

For later use, e.g. in other vehicles, you can store the vehicle contacts list and POIs previously downloaded (see "Creating and downloading user defined POIs" below) on a USB device:

Select **Upload Saved Locations**.

The contacts list and POI data is stored on the connected USB device in the folders "F:\myContacts" or "F:\myPOIs", where "F:\:" is the root folder of the USB device.

Note

This function may only be carried out if a USB device with sufficient storage space is connected.

Autocomplete function

To delete the list of destination entries used by the autocomplete function, select **Delete Autocomplete**.

Downloading contacts data

You can exchange your vehicle contacts list data with Infotainment systems in other vehicles:

To upload the data to a USB device, see "Uploading destination data to a USB device" above.

Connect the USB device to the Infotainment system of another vehicle ⇨ 40.

A message is displayed that prompts you to confirm the download.

After confirmation, the contacts data is downloaded to the Infotainment system.

The downloaded contacts are then selectable via the **CONTACTS** menu ⇨ 23.

Creating and downloading user defined POIs (My POIs)

In addition to the predefined POIs already stored in the Infotainment system, you can create user defined POIs that meet your personal requirements. After creation, such

user defined POIs can be downloaded to the Infotainment system.

For each POI, you need to define the GPS coordinates (longitude and latitude values) of the respective location and a descriptive name.

After downloading the POI data to the Infotainment system, you will find the respective POIs as selectable destinations in the **My POIs** menu, see "POIs entry" in chapter "Destination input" ↷ 53.

Creating a text file with POI data

Create a text file (e.g. by using a simple text editor software) with an arbitrary name and the file extension **.poi**, e.g. "TomsPOIs.poi".

Note

Character encoding **UTF-8** (Unicode) must be selected when storing the text file. Otherwise the POI data may not be imported correctly to the system.



Enter the POI data into the text file in the following format:

Longitude coordinate, Latitude coordinate, "Name of POI", "Additional information", "Phone number"

Example:

7.0350000, 50.6318040, "Michaels Home", "Bonn, Hellweg 6", "02379234567", see illustration above.

The GPS coordinates must be expressed in decimal degrees and can be taken, e.g., from a topographical map.

The additional information and phone number strings are optional. If, e.g., no additional information is required, "" must be entered at the respective position.

Example:

7.0350000, 50.6318040, "Michaels Home", "", "02379234567".

The POI name and the additional information string may not exceed 60 characters each. The phone number string may not exceed 30 characters.

The POI data of each destination address must be entered in a single separate line, see illustration above.

Storing the POI data on a USB device

In the root directory of a USB device, create a folder named **"myPOIs"**, e.g. "F:\myPOIs", where "F:" is the root directory of the USB device.

In the "myPOIs" folder, store the text file with your POIs, e.g. "F:\myPOIs\TomsPOIs.poi".

Organising the POI data in several subfolders

Optionally, you can organise the text files in several randomly named subfolders (max. depth of subfolder structure: 2).

Examples: F:\myPOIs\AnnsPOIs or F:\myPOIs\MyJourney\London, where F:\ is the root directory of the USB device.

Note

In a folder, only subfolders or only POI files may be stored. A mixture of both will not be imported correctly to the system.

After downloading individual POI data organised in that way to the Infotainment system (see download description further below), the **My POIs** menu will show a list of selectable submenus.

After selecting a submenu, further submenus or the related list of imported POI categories will be displayed.

Downloading the POI data to the Infotainment system

Connect the USB device with your user defined POI data to the USB port ↗ 40 of the Infotainment system.

A message is displayed that prompts you to confirm the download.

After confirmation, the POI data will be downloaded to the Infotainment system.

The downloaded POIs are then selectable as destinations via the **My POIs** menu, see "POIs entry" in chapter "Destination input" ↗ 53.

Destination input

The navigation application provides different options to set a destination for route guidance.

Press **HOME** and then select **NAV** to display the navigation map.

Select **DESTINATION** in the interaction selector bar and then select one of the different address entry options.



One-shot destination entry

Touch the entry field in the top line of the menu. A keyboard is displayed.

For a detailed description on the keyboards ↗ 18.

Enter an address or search term and confirm your input.

Two lists with possible destinations are created. To switch between the list tabs, touch **Address** or **POI** in the top line of the screen.

Address list:



POI list:



For a detailed description on POIs, see "POIs entry" below.

Select one of the destinations. The destination details view is displayed.



To start route guidance, select **Go**.

Address entry screen

Select **ADDRESS**. The **Address Entry** screen is displayed.



Touch one of the entry fields next to the address part entries. A keyboard is displayed.

For a detailed description on the keyboards ↗ 18.

Enter the required destination information.

Note

The screen does not need to be filled out completely.

To confirm your input, select ✓ in the top right corner of the screen.

If there is more than one destination possible according to the information entered, a list of all matching destinations found is displayed. Select the desired address.

The destination details view is displayed.

To start route guidance, select **Go**.

Crossroad entry screen

Select **CROSSROADS**. The **Crossroads Entry** screen is displayed.



Touch one of the entry fields next to the address part entries. A keyboard is displayed.

For a detailed description on the keyboards ⇨ 18.

Enter the required destination information.

To confirm your input, select ✓ in the top right corner of the screen.

If there is more than one destination possible according to the information entered, a list of all matching destinations found is displayed. Select the desired address.

The destination details view is displayed.

To start route guidance, select **Go**.

POIs entry

A point of interest (POI) is a specific location that might be of general interest, e.g. a petrol station, a parking area or a restaurant.

The data stored within the navigation system contains a great number of predefined POIs, which are indicated on the map (if activated, ⇨ 47).

You may also store individual POIs within the system, see "Creating and downloading user defined POIs (My POIs)" in chapter "Usage" ⇨ 47.

Those POIs are selectable as destinations via the POI main category **My POIs**.

To select a POI as a destination for route guidance, select **DESTINATION** in the interaction selector bar and then select **POIs**. A list for search area selection is displayed.

Setting a search location

Select one of the options.



Note

The options **POIs along Route** and **POIs near Destination** are only available when route guidance is active.

If **POIs at Another Location** is selected, a keyboard is displayed.

For a detailed description on the keyboards ⇨ 18.

Enter the desired location and confirm your entry.

A list of POI categories is displayed.

Searching POIs via categories

Select one of the main categories in the list. A list with subcategories is displayed.

To display all POIs available in the respective main category, select **List All**. Scroll through the list and select the desired POI.

To display all POIs within one subcategory, select the respective subcategory. Scroll through the list and select the desired POI.

The destination details view is displayed.

For more information on the POI selected, touch **Info** in the top right corner of the screen.

To start route guidance, select **Go**.

Searching POIs via name input

To search for a particular POI, a category or a specific location, select **Spell Name** in the POI main categories list or in one of the subcategory lists. A keyboard is displayed.

For a detailed description on the keyboards ⇨ 18.

Enter the desired name or category.

Select **✓** to confirm your input. The destination details view is displayed.

For more information on the POI selected, touch **Info** in the top right corner of the screen.

To start route guidance, select **Go**.

Recent destinations list

Select **RECENT**.

A list of all recently entered destinations is displayed.



Select one of the entries. The destination details view is displayed.

To start route guidance, select **Go**.

Contacts list

Select **CONTACTS**. The contacts list is displayed.



Quick function icon

If there is only one address stored for a contact, a quick route icon is displayed next to the respective entry in the contacts list.

Select **R** to directly display the destination details view.

To start route guidance, select **Go**.

Contact details view

If there is more than one address stored for a contact, select the desired contacts entry. The contact details view is displayed.

Select one of the addresses stored for the contact. The destination details view is displayed.

To start route guidance, select **Go**.

Selecting an address from the map

Tap on the desired location on the map. The map centres around this location.

A red **O** is displayed at the respective location and the corresponding address is shown on a label.



Tap on the label. The destination details view is displayed.

To start route guidance, select **Go**.

Waypoint trips

A waypoint is an intermediate destination that is considered in the calculation of a route to its final destination. To create a waypoint trip, you may add one or several waypoints.

Enter or select the final destination of your waypoint trip and start route guidance.

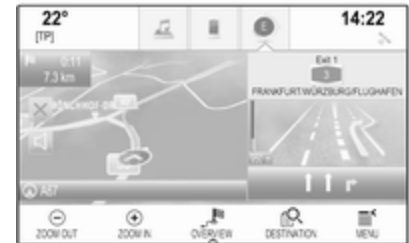

While under active route guidance, select **DESTINATION** in the interaction selector bar of the map view.

Alternatively, touch the arrow symbol indicating your next turning manoeuvre on the right side of the screen to display the route guidance menu. Select **DESTINATION** in the interaction selector bar of the route guidance menu.

Enter or select a new address.



Select **Go**. You are prompted with a message.



Select **Add as Waypoint**. The route is recalculated and the new destination is added as a waypoint to the current route.

If desired, enter further waypoints as described above.



To save the entire route with waypoints, select **Save**.

The waypoint trip is saved in the contacts list in the **Saved Trips** folder and designated according to its final destination.

The saved waypoint trip can be recalled via the contacts list.

For a detailed description on how to edit a waypoint trip ↗ 59.

New destination

To set a new destination, you may cancel route guidance to the current destination and then enter a new destination. Or you may directly enter a new destination.

While under active route guidance, select **DESTINATION** in the interaction selector bar of the map view.

Alternatively, touch the arrow symbol indicating your next turning manoeuvre on the right side of the screen to display the route guidance menu. Select **DESTINATION** in the interaction selector bar of the route guidance menu.

Enter or select a new address.

Select **Go**. You are prompted with a message.

Select **Set New Destination**. The route is recalculated and the new destination is set.

Calling a destination

After entering a destination and before starting route guidance, the destination details view is displayed.

To initiate a phone call to the selected location, select **Call**.

Note

The **Call** screen button is only available if a phone number is stored for the respective location.

Storing destinations

Contacts entry

After entering a destination and before starting route guidance, the destination details view is displayed.

To save the respective destination in the contacts list, select **Save**. For a detailed description on how to save an address in the contacts list ↷ 23.

Note

The **Save** screen button is only available if the address has not yet been stored in the system.

Favourite

Favourites may be stored from almost all screen views.

For a detailed description on how to store destination favourites ↷ 19.

Guidance

Route guidance is provided by the navigation system through visual instructions and voice prompts (voice guidance).

Visual instructions

Visual instructions are provided on the displays.

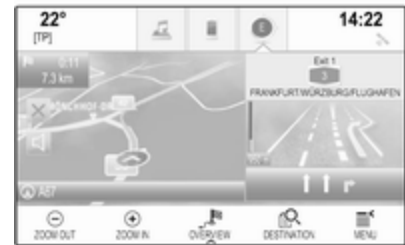

Navigation voice prompts

Navigation voice prompts announce which direction to follow, when approaching an intersection at which you need to turn.

To activate the voice prompts function and set the volume, see "Navigation voice settings" below.

Starting and cancelling route guidance

Starting route guidance

To start route guidance to a new destination chosen, select **Go** in the destination details view.

To directly start route guidance to the last destination chosen, select **MENU** in the interaction selector bar and then select **Resume to**.

Route guidance to the last destination selected is restarted.

Cancelling route guidance



To cancel route guidance, you may optionally:

- Touch **X** on the navigation map screen.
- Select **MENU** in the interaction selector bar and then select **Cancel Route**.
- Touch the arrow symbol indicating your next turning manoeuvre on the right side of the screen to display the route guidance menu.

Select **END** in the interaction selector bar.

Navigation voice settings

Mute

To temporarily mute the output of navigation voice prompts, select  on the left side of the map screen. The icon changes to .

To unmute the system, select  again.

Voice prompts

Select **MENU** in the interaction selector bar and then select **Navigation Voice Preferences** to display the respective submenu.

If **Voice Prompts - On** is set, navigation voice prompts are read out by the system during active route guidance.

Set **Voice Prompts - On** or **Voice Prompts - Off**.

If set to **Off**, no navigation voice prompts are provided by the system.

Voice prompts during phone calls

Select **MENU** in the interaction selector bar and then select **Navigation Voice Preferences** to display the respective submenu. Select **Prompts During Phone Calls**.

If **On** is selected, navigation voice prompts are also read out during phone calls.

If **Off** is selected, no voice prompts are given out. If **Beeps** is selected, a beep sounds instead of the announcement.

Volume

To adjust the volume of the voice prompts, select **-** or **+**.

Information on traffic incidents

Traffic list

To display a list of traffic incidents close to the current location of the vehicle, press **HOME** and then select **TRAFFIC**.

Alternatively, select **MENU** in the interaction selector bar and then select **Traffic** to display the respective submenu. Select **Show Nearby Traffic Incidents**.

If route guidance is not active, the list is displayed as follows:



If route guidance is active, two additional screen buttons are displayed: **All** for a list displaying all traffic incidents and **Along Route** for a list displaying only those traffic incidents regarding your current route.

By default, the list is sorted by distance from the vehicle location. To sort the list alphabetically, select **Sort** in the top line of the screen.

Touch one of the list elements to display detailed information on the respective traffic incident.

Note

If the traffic list has been entered via the **TRAFFIC** screen button on the home screen, touch  in the top left corner of the screen to enter the menu for traffic settings.

Traffic icons on the map

If **Show Icons on Map - On** is set, traffic incident icons around the current location and along the route are displayed on the map.

Set **Show Icons on Map - On** or **Show Icons on Map - Off**.

Traffic routing

This submenu contains settings of how the system may deal with traffic incidents before and during route guidance.

Select **Traffic Routing Preferences** to display the respective submenu.

If you wish slow traffic to be generally avoided, set **Avoid Slow Traffic** to **On**. Select **Automatically Avoid Traffic** or **Ask Me before Avoiding**.

Types of traffic incidents

Select **Traffic Types** to display the respective submenu.

Select the types of traffic incidents to be avoided.

TMC stations

The TMC radio stations supply information on the current traffic situation considered in the calculation of the route.

Note

Depending on the country you are in, the TMC service is enhanced by a PayTMC functionality integrated in the Infotainment system.

Select **TMC Station** to display the respective submenu.

The default setting is **Auto** consulting different TMC stations.

If you wish a specific TMC station to be observed, select the respective station from the list.

If this station is no longer received, the system switches back to the **Auto** function.

Route settings

Select **MENU** in the interaction selector bar and then select **Routing Preferences** to display the respective submenu.

Route style

To define by what criteria a route may be calculated, select **Route Style**.

Select **Fast**, **Eco Friendly** or **Short** from the list.

If **Eco Friendly** has been selected, the eco-friendly route style may be adapted to the load of the vehicle.

Select **Edit Eco Profile** to display the respective submenu.

Repeatedly select **Roof Load** and **Trailer** to toggle between the available load options. Set the options as needed.

Road selection

Select from the list which road types may be included in the calculation of the route.

Route modification

To modify the route during active route guidance, touch the arrow symbol indicating your next turning manoeuvre on the right side of the screen.

The route guidance menu is displayed.

Note

The route guidance menu may only be displayed if route guidance is active.

The route guidance menu provides additional options to change route settings during active route guidance.

Displaying the turn list

The turn list displays all streets on the calculated route, starting from the current location.

Select **TURN LIST** in the interaction selector bar of the route guidance menu. The turn list is displayed and the next manoeuvre is read out by the system.



Each list entry may show the following information:

- name of the street, motorway or motorway junction
- direction arrow
- distance to the next street on the route
- estimated arrival time to reach the next street

To display all available information on a particular list item, select the respective list item and then select **Info** in the top line of the screen.

Excluding streets from route guidance

After route guidance has been started, you may exclude streets from the previously calculated route. The route is then recalculated bypassing the streets excluded.

Select **AVOID** in the interaction selector bar of the route guidance menu. The turn list is displayed.

Select the street, motorway or motorway junction you wish to avoid. You are prompted with a message.

Select the desired distance option.

The respective street or motorway is displayed in the **Avoided Areas** section on top of the turn list indicated by a red ✓.

Note

The **Avoided Areas** section also comprises roads automatically avoided by the system due to traffic incidents.

To reinclude the avoided street or motorway into the route, deselect the respective list item.

Displaying the waypoint list

If you are in a waypoint trip, the route guidance menu comprises additional menu functions for waypoint trip modification.

The waypoint list displays all waypoints of the calculated waypoint trip, starting with the next upcoming waypoint.

Select **WAYPOINTS** in the interaction selector bar of the route guidance menu. The waypoints list is displayed.



Each list entry may show the following information:

- name or address of the waypoint
- distance to the next waypoint
- estimated arrival time to reach the next waypoint

Editing the waypoint trip

To arrange a waypoint trip as desired, select **EDIT** in the interaction selector bar of the route guidance menu. The waypoints list is displayed.

To change the position of the waypoints within the list, select ▲ and ▼ next to the respective list items.

To delete a waypoint from the list, select X.

Select **Save** at the top of the screen to save the changes.

Optimising the waypoint trip

If several waypoints have been added and the waypoint trip has been edited several times, you may want to rearrange the waypoints in the most efficient order.

Select **OPTIMISE** in the interaction selector bar of the route guidance menu.

Wait until the waypoints list has been updated.

Select **Save** at the top of the screen to save the changes.

Speech recognition

General information	65
Usage	67

General information

Embedded speech recognition

The embedded speech recognition of the Infotainment system enables you to operate various functions of the Infotainment system via voice input. It recognises commands and numeric sequences independently of the relevant speaker. The commands and numeric sequences can be spoken without a voice pause between the individual words.

In the event of incorrect operation or commands, the speech recognition gives visual and/or acoustic feedback and requests you to re-enter the desired command. Apart from this, the speech recognition acknowledges important commands and will enquire if necessary.

In general, there are different ways to speak commands for performing the desired actions.

Note

To ensure that conversations inside the vehicle do not lead to unintentional triggering of the

system functions, the speech recognition does not start until it has been activated.

Important information

Language support

- Not all languages available for the display of the Infotainment system are also available for the speech recognition.
- If the display language currently selected is not supported by the speech recognition, speech recognition is not available.

In such a case, you need to select another language for the display if you want to control the Infotainment system via voice input. To change the display language, see "Language" in chapter "System settings" ⇨ 28.

Address input of destinations in foreign countries

In case you want to enter the address of a destination located in a foreign country via voice input, you need to change the language of the Info-Display to the language of the foreign country.

E.g., if the display is currently set to English and you want to enter the name of a city located in France, you need to change the display language to French.

Exceptions: If you want to enter addresses in Belgium, you may optionally change the display language to French or Dutch. For addresses in Switzerland you may optionally change the display language to French, German, or Italian.

For changing the display language, see "Language" in chapter "System settings" ⇨ 28.

Input order for destination addresses

The order in which the parts of an address need to be entered using the speech recognition system is dependent on the country where the destination is located.

- Austria, Germany:
<city> <street> <house number>
- Belgium, France, Great Britain:

<house number> <street> <city>

- Denmark, Italy, Netherlands, Poland, Portugal, Russia, Spain, Switzerland, Turkey:

<street> <house number> <city>

Setting up the speech recognition

Several settings and adaptations for the embedded speech recognition of the Infotainment system can be performed.

Press **HOME** and then select the **SETTINGS** icon.

Select **Voice** item to enter the respective submenu.

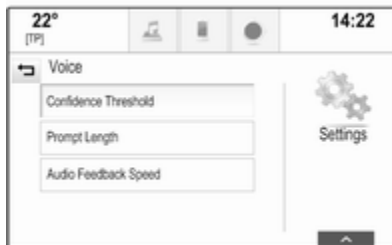

Confidence Threshold

Depending on the option selected in the corresponding submenu, the speech recognition appears more or less 'confident' in correctly understanding your commands.

Confirm More: If selected, the system asks you relatively often to confirm your commands. Consequently, the system performs the correct action in most cases.

Confirm Less: If selected, the system asks you less often to confirm your voice inputs. Consequently, the system might sometimes misinterpret your commands and not perform the correct action.

Note

When starting to use the speech recognition, it may be advantageous to use the **Confirm More** setting. As you get more experienced, i.e., you get to know how to pronounce your commands in a way the speech recognition understands you correctly, it may be advantageous to use the **Confirm Less** setting.

Prompt Length

The length and the level of detail of the questions and statements the speech recognition gives out can be adjusted in the corresponding submenu.

Audio Feedback Speed

The speed with which the speech recognition asks questions or makes statements can be adjusted in the corresponding submenu.

If **Medium** is selected, the system's speech rate corresponds to natural speech.

Note

When starting to use the speech recognition, it may be advantageous to use the **Long** setting. As you get more experienced, it may be advantageous to use the **Short** setting.

Display "What Can I Say?" Tips

Depending on whether you want possible speech commands to be displayed on the screen, set **Display "What Can I Say?" Tips** to **On** or **Off**.

Voice pass-thru application

The voice pass-thru application of the Infotainment system allows access to the speech recognition commands on your smartphone.

The availability of this function depends on your smartphone. For more information on compatibility, see our website.

Usage

Embedded speech recognition

Activating speech recognition

Note

Speech recognition is not available during an active phone call.

Activation via the button on the steering wheel

Press  on the steering wheel.

The audio system mutes, a voice output message prompts you to say a command, and help menus with the most important commands currently available are shown on the Info-Display or in the Driver Information Centre.

As soon as the speech recognition is ready for voice input, a beep is heard. The speech recognition symbol in the upper left corner of the help menu changes from white to red.

You can now say a voice command to initiate a system function (e.g. playing a preset radio station).

Activation via the VOICE screen button on the centre display



Select **VOICE** in the interaction selector bar of a centre display main menu.

The audio system mutes, a voice output message prompts you to say a command, and a help menu with the most important commands currently available is shown on the centre display.

As soon as the speech recognition is ready for voice input, a beep is heard. The speech recognition symbol on the right side of the help menu changes from black to red.

You can now say a voice command, see description above.

Adjusting the volume of voice prompts

Press  or  on the steering wheel upwards (increase volume) or downwards (decrease volume).

Interrupting a voice prompt

As an experienced user, you can interrupt a voice prompt by briefly pressing  on the steering wheel.

A beep is heard immediately, the speech recognition symbol changes to red, and a command can be stated without having to wait.

Cancelling a dialogue sequence

There are various ways to cancel a dialogue sequence and to deactivate the speech recognition:

- Say "**Cancel**" or "**Exit**".
- Press  on the steering wheel.
- If the speech recognition session was started via the **VOICE** screen button on the centre display, you may alternatively:

- Press **HOME** on the control panel.
- Select  or **Exit** in the help menu.

In the following situations, a dialogue sequence is automatically cancelled:

- If you do not say any command for a certain period of time (by default you are prompted three times to say a command).
- If you say commands that are not recognised by the system (by default you are prompted three times to say a correct command).

Operation via speech commands

The speech recognition can understand commands that are either naturally stated in sentence form, or direct commands stating the application and the action.

For best results:

- Listen for the voice prompt and wait for the beep before saying a command or replying.
- Say "**Help**" or read the example commands on the screen.

- The voice prompt can be interrupted by pressing  again.
- Wait for the beep and then speak the command naturally, not too fast, not too slow. Use short and direct commands.

Usually commands can be spoken in a single command. For example, "Call David Smith at work", "Play" followed by the artist or song name, "Tune to" followed by the radio waveband and frequency/station name, or "Find address" followed by the address e.g. "123 Main Road, London".

In case of complex commands or when information is missing, the system starts a dialogue sequence.

When searching for a "Point of Interest", only major chains may be selected by name. Chains are businesses with at least 20 locations. For other POIs, say the name of a category, e.g. "Restaurants", "Shopping centres", or "Hospitals".

If you say "Phone" or "Phone commands", the system understands that a phone call is requested and responds with relevant questions until

enough details are gathered. If the phone number has been saved with a name and a place, the direct command should include both, for example "Call David Smith at work".

Selecting list items

When a list is displayed, a voice prompt asks to confirm or select an item from that list. A list item may be manually selected, or by speaking the line number of the item.

The list on a speech recognition screen functions the same as a list on other screens. Manually scrolling the list on a screen during a speech recognition session suspends the current speech recognition event and plays a prompt like "Make your selection from the list using the manual controls, press the back button on the faceplate, or press the back screen button to try again".

If no manual selection is made within 15 seconds, the speech recognition session terminates, you are prompted with a message, and the former screen is redisplayed.

The "Back" command

To return to the previous menu, optionally: say "Back", press ◀ **BACK** on the control panel, or press ↶.

The "Help" command

After saying "Help", the help prompt for the current screen is read aloud. Additionally, the prompt is displayed on the screen.

Depending on how speech recognition was initiated, the help prompt is either displayed in the Driver Information Centre or on the centre display.

To interrupt the help prompt, press Ⓢ. A beep is heard. You may say a command.



Voice pass-thru application

Activating speech recognition

Press and hold Ⓢ on the steering wheel until a speech recognition icon is displayed in the Driver Information Centre.

In addition, a message in the Driver Information Centre informs you when the voice pass-thru application is ready for use.

Adjusting the volume of voice prompts

Turn  on the control panel or press  or  on the steering wheel upwards (increase volume) or downwards (decrease volume).

Deactivating speech recognition

Press  on the steering wheel. The speech recognition session is ended.

Phone

General information	70
Bluetooth connection	71
Emergency call	73
Operation	73
Text messages	77
Mobile phones and CB radio equipment	79

General information

The Phone portal provides you with the possibility of having mobile phone conversations via a vehicle microphone and the vehicle loudspeakers as well as operating the most important mobile phone functions via the Infotainment system in the vehicle. To be able to use the Phone portal, the mobile phone must be connected to the Infotainment system via Bluetooth.

Not all Phone functions are supported by every mobile phone. The usable phone functions depend on the relevant mobile phone and network provider. You will find further information on this in the operating instructions for your mobile phone, or you can enquire about them with your network provider.

Important information for operation and traffic safety

Warning

Mobile phones have effects on your environment. For this reason, safety regulations and directions have been prepared. You should be familiar with the related directions before you use the telephone function.

Warning

Use of the hands-free facility while driving can be dangerous because your concentration is reduced when telephoning. Park your vehicle before you use the hands-free facility. Follow the stipulations of the country in which you find yourself at present.

Do not forget to follow the special regulations that apply in specific areas and always switch off the mobile phone if the use of mobile phones is prohibited, if

interference is caused by the mobile phone or if dangerous situations can occur.

Bluetooth

The Phone portal is certified by the Bluetooth Special Interest Group (SIG).

You will find further information about the specification on the internet at <http://www.bluetooth.com>

Bluetooth connection

Bluetooth is a radio standard for the wireless connection of e.g. mobile phones or other devices.

To be able to set up a Bluetooth connection to the Infotainment system, the Bluetooth function of the Bluetooth device must be activated. For further information, please consult the operating instructions for the Bluetooth device.

Via the Bluetooth settings menu, pairing (PIN code exchange between Bluetooth device and Infotainment

system) and connecting of the Bluetooth devices to the Infotainment system are carried out.

Bluetooth settings menu

Press **HOME** and then select the **SETTINGS** icon.

Select **Bluetooth** to display the respective submenu.

Pairing a device

Important information

- Up to five devices can be paired to the system.
- Only one paired device can be connected to the Infotainment system at a time.
- Pairing normally only needs to be carried out once, unless the device is deleted from the list of paired devices. If the device has been connected previously, the

Infotainment system automatically establishes a connection.

- Bluetooth operation considerably drains the device's battery. Therefore, connect the device to the USB port for charging.

Pairing via the Settings application

1. Press **HOME** and then select the **SETTINGS** icon.

Select **Bluetooth** to display the respective submenu.

2. Select **Pair Device**.

Alternatively, select **Device Management** to display the device list and then select **Pair Device**.

3. A message is displayed on the Infotainment system indicating the name and PIN code of the Infotainment system.
4. Start Bluetooth searching on the Bluetooth device to be paired.
5. Confirm the pairing procedure:
 - If SSP (secure simple pairing) is supported:

Compare the PIN code (if demanded) and confirm the messages on the Infotainment system and the Bluetooth device.

- If SSP (secure simple pairing) is not supported:

If desired, select **Set PIN** to change the PIN code of the Infotainment system. A keypad is displayed. Enter the new PIN code and confirm your input.

Enter the Infotainment PIN code on the Bluetooth device and confirm your input.

6. The Infotainment system and the device are paired and the device list is displayed.

Note

If the Bluetooth connection fails, a failure message is displayed on the screen of the Infotainment system.

7. If available on the Bluetooth device, phone book and calls lists are downloaded to the Infotainment system. If required,

confirm the respective message on your smartphone.

Note

For the contacts to be read by the Infotainment system, they have to be stored in the phone memory of the mobile phone.

If this function is not supported by the Bluetooth device, a corresponding message is displayed on the Infotainment system.

Pairing via the Phone application

1. Press **HOME** and then select the **PHONE** icon.
2. Select **Pair Device**.
3. Proceed from step 3 of "Pairing via the Settings application" (see above).
4. If the device has been successfully paired, the phone menu is displayed.

Note

If the Bluetooth connection fails, a failure message is displayed on the screen of the Infotainment system.

Connecting a paired device

1. Press **HOME** and then select the **SETTINGS** icon.
Select **Bluetooth** to display the respective submenu.
2. Select **Device Management** to display the device list.
3. Select the Bluetooth device you wish to connect.
4. The device is connected and displayed within the **Connected** field of the device list.

Disconnecting a device

1. Press **HOME** and then select the **SETTINGS** icon.
Select **Bluetooth** to display the respective submenu.
2. Select **Device Management** to display the device list.
3. Select **X** beside the Bluetooth device currently connected. You are prompted with a message.
4. Select **Yes** to disconnect the device.

Deleting a device

1. Press **HOME** and then select the **SETTINGS** icon.
Select **Bluetooth** to display the respective submenu.
2. Select **Device Management** to display the device list.
3. Select – beside the Bluetooth device to be deleted. You are prompted with a message.
4. Select **Yes** to delete the device.

Emergency call

⚠ Warning

Connection setup cannot be guaranteed in all situations. For this reason you should not rely exclusively on a mobile phone when a vitally important communication (e.g. a medical emergency) is concerned.

In some networks it may be necessary for a valid SIM card to be properly inserted in the mobile phone.

⚠ Warning

Bear in mind that you can make and receive calls with the mobile phone if it is in a service area with a sufficiently strong signal. Under certain circumstances, emergency calls cannot be made on all mobile phone networks; it is possible that they cannot be made when certain network services and/or telephone functions are active. You can enquire about this with the local network operators.

The emergency call number can differ depending on the region and country. Please enquire beforehand about the correct emergency call number for the relevant region.

Making an emergency call

Dial the emergency call number (e.g. **112**).

The telephone connection to the emergency call centre is set up.

Answer when the service personnel questions you about the emergency.

⚠ Warning

Do not end the call until you are requested to do so by the emergency call centre.

Operation

As soon as a connection via Bluetooth has been set up between your mobile phone and the Infotainment system, you can operate many functions of your mobile phone via the Infotainment system.

Note

Not every mobile phone supports all functions of the Phone portal. Therefore, deviations from the range of functions described below are possible.

Phone application

Press **HOME** and then select the **PHONE** icon (with phone symbol) to display the respective menu.

The Phone portal comprises different views accessible via tabs. Select the desired tab.

Note

The phone main menu is only available if a mobile phone is connected to the Infotainment system via Bluetooth. For a detailed description ↗ 71.

Initiating a phone call**Keypad**

Press **HOME** and then select the **PHONE** icon to display the respective menu.

If necessary, select **KEYPAD** in the interaction selector bar. The keypad is displayed.

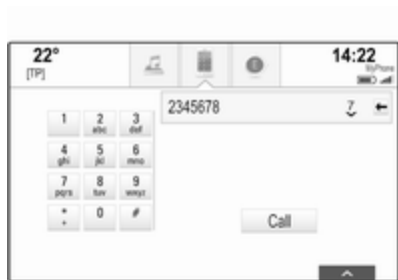

Enter the desired number and select **Call**. The number is dialed.

To dial a speed dial number, enter the number and touch and hold the last digit. The number is dialed.

Contacts

Press **HOME** and then select the **PHONE** icon to display the respective menu.

If necessary, select **CONTACTS** in the interaction selector bar. The contacts list is displayed.



For a detailed description of the contacts lists ↗ 23.

Scroll to the desired contacts entry.

Quick function icon

If there is only one number stored for a contact, a quick dial icon is displayed next to the respective entry in the contacts list.

Select ☎ to directly initiate the call.

Contact details view

If more than one number is stored for a contact, select the respective contact.

The contact details view is displayed.

Select one of the phone numbers stored for the contact. The number is dialed.

Calls lists

Press **HOME** and then select the **PHONE** icon to display the respective menu.

If necessary, select **RECENT** in the interaction selector bar. The recent calls list is displayed.



Note

Missed calls are highlighted in red in the recent calls list and indicated by a Δ next to the phone icon in the application tray.

Select one of the phone numbers stored in the recent calls list. The number is dialed.

Favourites

Reveal the favourites page.

If necessary, scroll through the pages.

Select the desired favourite screen button.

For a detailed description ⇨ 19.

Incoming phone call

Taking a phone call

If a radio or media source is active when a call comes in, the audio source is muted and remains muted until the call is ended.

A message with the caller's name or number is displayed at the bottom of the screen.



To answer the call, select **Answer** in the message.

Rejecting a phone call

To reject the call, select **Ignore** in the message.

Changing the ringtone

Press **HOME** and then select the **SETTINGS** icon.

Select **Bluetooth** to display the respective submenu and then select **Ringtones**. A list of all phones paired to the Infotainment system is displayed.

Select the desired phone. A list of all ringtones available for the respective phone is displayed.

Select the desired ringtone.

Functions during a phone call

During a phone call, the in-call view is displayed.

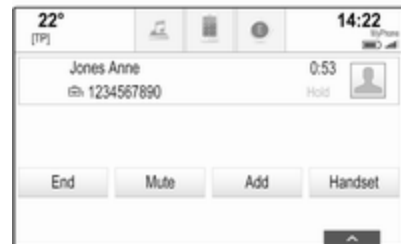

Ending a phone call

Select **End** to end the call.

Deactivating the microphone

Select **Mute** to temporarily deactivate the microphone.

The screen button changes to

Unmute.

To reactivate the microphone, select

Unmute.**Deactivating the hands-free function**

To continue the conversation on your mobile phone, select **Handset**.

The screen button changes to

Handsfree.

To reactivate the hands-free function, select **Handsfree**.

Second phone call**Initiating a second phone call**

To initiate a second phone call, select **Add** in the in-call view. The phone menu is displayed.

Initiate a second phone call. For a detailed description, see above.

To cancel the initiation of the second call and return to the in-call view, select **Current Call**.

Both calls are displayed in the in-call view.

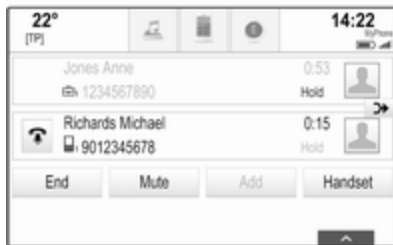
**Second incoming phone call**

A message with the caller's name or number is displayed at the bottom of the in-call view.

Select **Answer** or **Ignore** in the message.

Ending the phone calls

To end both calls, select **End** at the bottom of the screen.

To end just one of the calls, select **↵** next to the respective call.

Conference call

Select **➔** to merge the two calls. Both calls become active.

The **➔** screen button changes to **↵**.

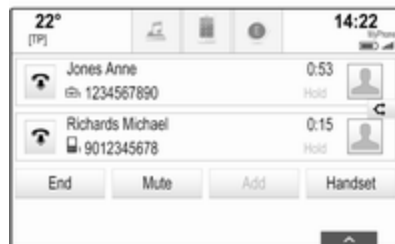

To unmerge the calls, select **↵**.

Phones

Select **PHONES** in the interaction selector bar to display the device list.



For a detailed description ⇨ 71.

Text messages

The **TEXT** application allows text messages to be received and replied to via the Infotainment system.

Note

If the vehicle is going faster than 8 km/h, some functions of the text application may not be available.

Prerequisites

The following prerequisites must be met in order to use the **TEXT** application:

- The Bluetooth function of the respective phone must be activated (see the operating instructions for the device).
- Dependent on the phone, it may be required to set the device to "visible" (see the operating instructions for the device).
- Depending on the phone, it may be required to manually allow access to the text messages function on the phone (see the operating instructions for the device).
- The respective phone must be paired and connected to the Infotainment system. For a detailed description ⇨ 71.
- The respective phone must support Bluetooth Message Access Profile (BT MAP).

Starting the text application

Press the **HOME** button and then select the **TEXT** application icon.



If a new text message is received, you are prompted with a message. Select one of the screen buttons to enter the **TEXT** application.

Note

Text message alerts are only displayed if **Text Alerts** in the text settings menu is set to **On**.

Listening to a message

Select **INBOX** in the interaction selector bar. The text messages stored on the respective phone are displayed in a list.

Note

Depending on the phone, not all text messages stored on the phone are displayed in the inbox.

To listen to a message, select  beside the respective message.

Alternatively, select the desired message to display the message view. Select **LISTEN** in the interaction selector bar.

Viewing a message

Select **INBOX** in the interaction selector bar. The text messages stored on the respective phone are displayed in a list.

Select the desired message to display the complete message text.



Calling the sender

Select **INBOX** in the interaction selector bar. The text messages stored on the respective phone are displayed in a list.

Select the desired message to display the message view.

Select **Call** in the interaction selector bar. The sender of the message is called.

Replying to a message

Note

Depending on the phone, the reply function may not be supported.

Select **INBOX** in the interaction selector bar. The text messages stored on the respective phone are displayed in a list.

Select the desired message to display the message view.

Select **REPLY** in the interaction selector bar. A list of predefined messages is displayed.

Select the desired predefined text message.

If none of the predefined messages serves your purpose, you can write a new message, see "Manage Predefined Messages" below.

Deleting a message

Select **INBOX** in the interaction selector bar. The text messages stored on the respective phone are displayed in a list.

Select the desired message to display the message view.

To delete the text message, select **Delete** in the interaction selector bar.

Device list

Select **PHONES** to display the device list.

For a detailed description ⇨ 71.

Text settings

Select **Settings** to enter the settings menu.

Text Alerts

If you wish an alert to pop-up when a new text message is received, set **Text Alerts - On**.

Manage Predefined Messages

Select **Manage Predefined Messages** to display a list of all predefined messages.

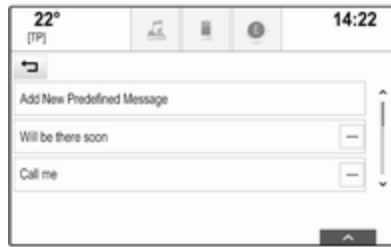

Adding a new message

Note

Predefined messages can only be entered when the vehicle is stationary.

Select **Add New Predefined Message**. A keyboard is displayed.

Enter the desired message text and confirm your input. The new message is added to the list of predefined messages.

Deleting a predefined message

To delete a predefined message, select – beside the message you wish to delete.

Mobile phones and CB radio equipment

Installation instructions and operating guidelines

The vehicle specific installation instructions and the operating guidelines of the mobile phone and hands-free manufacturer must be observed when installing and operating a mobile telephone. Failure to do so could invalidate the vehicle type approval (EU directive 95/54/EC).

Recommendations for fault-free operation:

- The exterior antenna must be professionally installed to obtain the maximum range possible.
- Maximum transmission power: 10 watts.
- The mobile phone must be installed in a suitable spot. Consider relevant note in the Owner's Manual, chapter **Airbag system**.

Seek advice on predetermined installation points for the external antenna or equipment holder and ways of using devices with a transmission power exceeding 10 watts.

Use of a hands-free attachment without external antenna with mobile telephone standards GSM 900/1800/1900 and UMTS is only permitted if the maximum transmission power of the mobile telephone is 2 watts for GSM 900 or 1 watt for the other types.

For reasons of safety, do not use the phone while driving. Even use of a hands-free set can be a distraction while driving.

Warning

Operation of radio equipment and mobile telephones which fail to meet above mentioned mobile telephone standards is only permitted using an antenna located outside of the vehicle.

Caution

Mobile telephones and radio equipment may lead to malfunctions in the vehicle electronics when operated inside the vehicle with no exterior antenna, unless the above mentioned regulations are observed.

Frequently asked questions

Frequently asked questions 81

Frequently asked questions

Phone

? How can I pair my phone with the Infotainment system?

- ! In order to pair a phone, press **HOME**, select the **PHONE** icon and then select **Pair Device**. Follow the instructions on your device and make sure Bluetooth is enabled.

Detailed description ⇨ 71.

? How can I access my phone book contacts and recent calls?

- ! In order to access the contacts or calls list, press **HOME**, select the **PHONE** icon and then select **CONTACTS** or **RECENT**. Make sure access to the phone book and recent calls list is allowed on the phone. Depending on the phone, loading the phone book and recent calls list might take a few minutes.

Detailed description ⇨ 73.

Favourites

? What can be stored as a favourite?

- ! Up to 60 favourites of almost all elements can be stored, e.g. destinations, phone contacts, playlists, radio stations, etc.

Detailed description ⇨ 19.

? How can I store a new favourite?

- ! Activate the respective application and touch and hold a favourite screen button to store a new favourite in this location. A short beep sound confirms storing. In some cases, it is required to select a specific item.

Detailed description ⇨ 19.

? How can I rename, delete or move my favourites?

- ! Press **HOME**, select the **SETTINGS** icon on the home screen, **Radio** in the settings list and then **Manage Favourites** in order to rename, delete or move the favourites.

Detailed description ⇨ 19.

❓ Where are the favourites stored and how can I recall them?

- ❗ The favourites are stored in the favourites list. To recall a favourite, select the respective screen button on the favourites row displayed. On certain screens, the favourites list is hidden to extend the main content view. On these screens, select  on the lower right of the screen or drag the interaction selector bar upwards with the finger.

Detailed description ⇨ 19.

Navigation

❓ After entering a destination address, an error message is shown. What am I doing wrong?

- ❗ For full address entry, the navigation system expects a certain input order. Depending on the country in which the entered address is located, a different input order might be required. Add the country name at the end of the entry, if a destination in another country has been entered.

Detailed description ⇨ 53.

❓ How can I cancel active route guidance?

- ❗ To cancel route guidance, select **MENU** in the interaction selector bar and then select **Cancel Route**.

Detailed description ⇨ 59.

Audio

❓ How can I change the audio source?

- ❗ By pressing **RADIO** repeatedly, you can toggle through all available radio sources (AM/FM/DAB). By pressing **MEDIA** repeatedly, you can toggle through all available media sources.

Detailed description for radio ⇨ 32, CD ⇨ 37, external devices ⇨ 40.

❓ How can I browse radio stations or media music?

- ❗ To browse radio stations or media music, such as playlists or albums, select **BROWSE** on the audio screen.

Detailed description for radio ⇨ 32, CD ⇨ 38, external devices ⇨ 41.

Other

❓ How can I improve the performance of the voice recognition?

- ❗ The voice recognition is designed to understand naturally pronounced voice commands. Wait for the beep tone and speak afterwards. Try to speak naturally, not too fast or too loud.

Detailed description ⇨ 65.

❓ How can I improve the touch screen's performance?

- ❗ The touch screen is pressure-sensitive. Especially when doing drag gestures, try to apply more pressure with the finger.

Detailed description ⇨ 15.

Index

- A**
- Activating Bluetooth music..... 41
 - Activating CD player..... 38
 - Activating phone projection..... 43
 - Activating radio..... 32
 - Activating the Infotainment system 12
 - Activating the navigation system. . 47
 - Activating the phone portal..... 73
 - Activating USB..... 41, 42
 - Address book..... 53
 - Application tray..... 17
 - Audio files..... 40
 - Automatic volume adjustment
 - Auto volume..... 27
 - Auto Set..... 28
 - Auto volume..... 27
- B**
- Balance..... 27
 - Basic operation..... 15
 - Application tray..... 17
 - Character recognition pane..... 18
 - Contacts..... 23
 - Favourites..... 19
 - Home screen..... 17
 - Interaction selector bar..... 17
 - Keyboard..... 18
 - Keypad..... 18
 - Bass..... 27
- Bluetooth connection**..... 71
- Bluetooth music**..... 40
- C**
- Category list..... 32
 - CD player..... 37
 - Character modifiers..... 18
 - Character recognition pane..... 18
 - Clock display..... 28
 - Contacts..... 23, 53
 - Modifying..... 23
 - Retrieving..... 23
 - Storing..... 23
 - Control elements
 - Infotainment system..... 8
 - Steering wheel..... 8
 - Control elements overview..... 8
- D**
- DAB..... 35
 - DAB linking..... 35
 - Date..... 28
 - Destination input 53
 - Digital audio broadcasting..... 35
 - Displaying favourites..... 19
 - Display mode..... 28
- E**
- Emergency call..... 73
 - EQ..... 27
 - Equaliser..... 27

F		I		N	
Fader.....	27	Individual POIs.....	47	Navigation.....	59
Favourites.....	19	Infotainment control panel.....	8	Contacts.....	23, 53
Cluster display.....	19	Intellitext.....	35	Current location.....	47
Deleting.....	19	Interaction selector bar.....	17	Destination input.....	53
Displaying.....	19	K		Favourites.....	19
Renaming.....	19	Keyboard		Individual POIs.....	47
Retrieving.....	19	Letter keyboard.....	18	Map display.....	47
Storing.....	19	Symbol keyboard.....	18	Map manipulation.....	47
File formats		Keyboards.....	18	Map update.....	46
Audio files.....	40	Keypad.....	18	OVERVIEW screen button.....	47
Movie files.....	40	L		Recent destinations.....	53
Forgotten PIN.....	28	Language.....	28	Route guidance.....	59
Frequency list.....	32	L-Band.....	35	Route guidance menu.....	59
Frequently asked questions.....	81	M		TMC stations.....	46, 59
G		Maps.....	47	Traffic incidents.....	59
General information 37, 40, 46, 65, 70		Maximum startup volume.....	27	Turn list.....	59
Bluetooth music.....	40	Menu operation.....	17	Voice prompts.....	59
CD.....	37	Messages.....	17	Waypoint list.....	59
Infotainment system.....	6	Midrange.....	27	Waypoint trip.....	53
Navigation.....	46	Mobile phones and CB radio		O	
Phone portal.....	70	equipment.....	79	Operation.....	73
Radio.....	32	Movie files.....	40	Bluetooth music.....	41
USB.....	40	Movies.....	42	CD.....	38
Guidance.....	59	Mute.....	12	Contacts.....	23
H				Favourites.....	19
Home button.....	17			Infotainment system.....	12
Home screen.....	17			Keyboards.....	18
				Navigation system.....	47

Phone.....	73
Radio.....	32
Touch screen.....	15
USB.....	41, 42
OVERVIEW screen button.....	47

P

Pairing.....	71
Phone	
Bluetooth.....	70
Bluetooth connection.....	71
Contacts.....	23
Emergency calls.....	73
Favourites.....	19
Hands-free mode.....	73
Phone book.....	23, 73
Recent calls.....	73
Ringtone.....	73
Text messages.....	77
Phone book.....	23, 73
Phone call	
Initiating.....	73
Rejecting.....	73
Taking.....	73
Phone projection.....	43
Playing audio.....	41
Playing movies.....	42
POIs.....	53

R

Radio

Category list.....	32
DAB.....	35
DAB announcements.....	35
DAB menu.....	35
Digital audio broadcasting.....	35
Favourites.....	19
FM menu.....	33
Frequency list.....	32
Intellitext.....	35
L-Band.....	35
Radio Data System.....	33
RDS.....	33
Region.....	33
Regionalisation.....	33
Station list.....	32
Station search.....	32
TP.....	33
Traffic Programme.....	33
Waveband.....	32
Radio data system (RDS)	33
Region.....	33
Regionalisation.....	33
RESET screen button.....	47
Retrieving favourites.....	19
Return to factory settings.....	28
Ringtone.....	73
Route guidance.....	59
Route style.....	59

S

Shop.....	43
Smartphone	
Phone projection.....	43
Speech recognition.....	65
Station list.....	32
Station search.....	32
Storing favourites.....	19
Switching the Infotainment system on.....	12
System settings.....	28
Display.....	28
Language.....	28
Return to factory settings.....	28
Time and Date.....	28
Valet mode.....	28

T

TA.....	33
Text messages.....	77
Theft-deterrent feature	7
Time.....	28
TMC stations.....	46
Tone settings.....	27
Touch screen.....	15
Touch screen calibration.....	28
Touch screen operation.....	15
TP.....	33
Traffic incidents.....	59
Traffic Programme.....	33

Treble.....	27
Turn list.....	59

U

Usage.....	12, 32, 38, 47, 67
Bluetooth music.....	41
CD.....	38
Infotainment system.....	12
Navigation system.....	47
Phone.....	73
Touch screen.....	15
USB.....	41, 42
USB.....	40
Using apps.....	43
Using smartphone applications....	43

V

Valet mode	
Locking.....	28
Unlocking.....	28
Voice recognition.....	65
Volume	
Auto Volume.....	27
Maximum startup volume.....	27
Mute function.....	12
Setting the volume.....	12
Volume settings.....	27

W

Waveband selection.....	32
Waypoint list.....	59

Waypoint trip.....	53
Wrong scrolling direction.....	28

R 4.0 IntelliLink

Introduction	90
Basic operation	98
Radio	104
External devices	110
Speech recognition	117
Phone	118
Index	128

Introduction

General information	90
Theft-deterrent feature	91
Control elements overview	92
Usage	95

General information

The Infotainment system provides you with state-of-the-art in-car infotainment.

Using radio tuner functions, you may register up to 25 stations on five favourites pages.

You can connect external data storage devices to the Infotainment system as further audio sources; either via cable or via Bluetooth®.

In addition, the Infotainment system is equipped with a phone portal that allows for comfortable and safe use of your mobile phone in the vehicle.

You can also operate specific smartphone applications via the Infotainment system.

Optionally, the Infotainment system can be operated using the touch screen and buttons on the control panel, the controls on the steering wheel, or - if provided by your mobile phone - via speech recognition.

The well-thought-out design of the control elements, the touch screen and the clear displays enable you to control the system easily and intuitively.

Note

This manual describes all options and features available for the various Infotainment systems. Certain descriptions, including those for display and menu functions, may not apply to your vehicle due to model variant, country specifications, special equipment or accessories.

Important information on operation and traffic safety

Warning

The Infotainment system must be used so that the vehicle can be driven safely at all times. If in doubt, stop the vehicle and operate the Infotainment system while the vehicle is stationary.

Radio reception

Radio reception may be disrupted by static, noise, distortion or loss of reception due to:

- changes in distance from the transmitter
- multipath reception due to reflection
- shadowing

Theft-deterrent feature

The Infotainment system is equipped with an electronic security system for the purpose of theft deterrence.

The Infotainment system therefore functions only in your vehicle and is worthless to a thief.

Control elements overview

Control panel



1 Display / touch screen 98

2 Home menu 98

Screen buttons for access to:

AUDIO: audio functions

GALLERY: picture and movie functions

PHONE: mobile phone functions

PROJECTION: phone projection

NAV: BringGo® app

SETTINGS: system settings

OnStar: OnStar Wi-Fi settings 95

3 Time, date and temperature indicators 102

4 

Short press: open phone menu 122

or open phone projection function (if activated) 115

Long press: activate speech recognition 117

5 

Short press: skip to next station when radio active 104

or skip to next track when external devices active 112

Long press: seek up when radio active 104

or fast forward when external devices active 112

6 

Short press: switch on Infotainment system if turned off 95

or mute system if turned on . 95

Long press: switch off Infotainment system 95

Turn: adjust volume 95

7 

Short press: skip to previous station when radio active 104

or skip to previous track when external devices active 112

Long press: seek down when radio active 104

or fast rewind when external devices active 112

8 

Short press: open home menu 95

Long press: open phone projection function (if activated) 115

Steering wheel controls

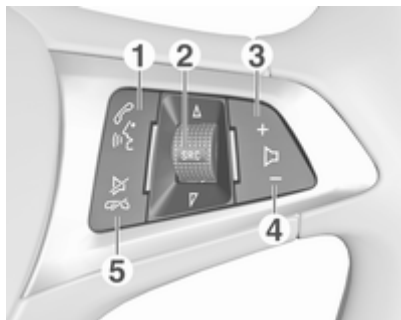

- 1**
- Short press: open OnStar menu if no phone connected 95
- or take phone call if phone connected 118
- or dial last number in call list when phone menu displayed 122

- or switch between calls when calls are waiting 122
- Long press: activate speech recognition 117
- 2** SRC (Source) 95
- Press: select audio source 95
- Turn upwards/downwards: select next/previous preset radio station when radio active 104
- or select next/previous track/chapter/picture when external devices active 112
- or select next/previous entry in call list when phone portal active and call list open 122
- Turn upwards/downwards and hold: scroll quickly through the entries in the call list 122
- 3** +
- Press: increase volume

- 4** -
- Press: reduce volume
- 5**
- Press: end/decline call 122
- or deactivate speech recognition 117
- or activate/deactivate mute function 95

Usage

Control elements

The Infotainment system is operated via function buttons, a touch screen and menus that are shown on the display.

Inputs are made optionally via:

- the central control unit in the control panel ↪ 92
- the touch screen ↪ 98
- audio controls on the steering wheel ↪ 92
- the speech recognition ↪ 117

Switching the Infotainment system on or off

Press . After switching on, the last selected Infotainment source becomes active.

Automatic switch-off

If the Infotainment system has been switched on by pressing  while the ignition is switched off, it will switch off again automatically 10 minutes after the last user input.

Setting the volume

Turn . The current setting is shown on the display.

When the Infotainment system is switched on, the last selected volume is set, provided that it is lower than the maximum start-up volume. For a detailed description ↪ 101.

Speed compensated volume

When the speed compensated volume is activated ↪ 101, the volume is adapted automatically to make up for the road and wind noise as you drive.

Mute

Press  to mute the Infotainment system.

To cancel the mute function: press  again. The last selected volume is set again.

Modes of operation

Press  to display the home menu.



Note

For a detailed description of menu operation via touch screen ↪ 98.

AUDIO

Select **AUDIO** to open the main menu of the last selected audio mode.

Select **Source** on the screen to display the interaction selector bar.



To change to another audio mode: touch one of the items in the interaction selector bar.

For a detailed description of:



- Radio functions ↗ 104
- External devices (**USB**, **Bluetooth**) ↗ 112

Note

To easily return to the audio screen currently active, touch  in the top line of any screen.

GALLERY

Select **GALLERY** to open the picture and movie menu for files stored on an external device, e.g. USB device or smartphone.

Select  or  to display the picture or movie menu. Select the desired picture or movie file to show the respective item on the display.



For a detailed description of:

- Picture functions ↗ 113
- Movie functions ↗ 114

PHONE

Before the phone portal can be used, a connection has to be established between the Infotainment system and the mobile phone.

For a detailed description of preparing and establishing a Bluetooth connection between the Infotainment system and a mobile phone ↗ 118.

If the mobile phone is connected, select **PHONE** to display the main menu of the phone portal.



For a detailed description of mobile phone operation via the Infotainment system ↗ 122.

PROJECTION

To show specific apps of your smartphone display on the Infotainment system, connect your smartphone.

Select **PROJECTION** to start the projection function.

Depending on the smartphone connected, a main menu with different selectable apps is displayed.

For a detailed description ⇨ 115.

NAV

To start the BringGo navigation application, select **NAV**.

For a detailed description ⇨ 115.

SETTINGS

Select **SETTINGS** to open a menu for various system related settings, e.g. deactivating **Audible Touch Feedback**.



OnStar

To display a menu with the OnStar Wi-Fi settings, select **OnStar**.

For a detailed description, see Owner's Manual.

Basic operation

Basic operation	98
Tone settings	100
Volume settings	101
System settings	102

Basic operation

The display of the Infotainment system has a touch-sensitive surface that allows direct interaction with the displayed menu controls.

Caution

Do not use pointed or hard items like ballpoint pens, pencils or similar for touch screen operation.

↩ screen button



When operating the menus, press ↩ in the respective submenu to return to the next higher menu level.

When no ↩ screen button is displayed, you are on the top level of the respective menu. Press ⏠ to display the home screen.

Selecting or activating a screen button or menu item



Touch a screen button or menu item. The corresponding system function is activated, a message is shown, or a submenu with further options is displayed.

Note

In subsequent chapters, the operating steps for selecting and activating a screen button or menu item via the touch screen will be described as "...select <button name>/<item name>".

Moving items on the home menu

Touch and hold the element you wish to move until red boxes appear around the icons. Move your finger to the desired location and release the element.

Note

Constant pressure must be applied and the finger must be moved at constant speed.

All other items are rearranged.

Press one of the buttons on the control panel to exit edit mode.

Note

Edit mode exits automatically after 30 seconds of inactivity.

Scrolling lists

If there are more items available than presentable on the screen, the list must be scrolled.

To scroll through a list of menu items, you may optionally:

- Place your finger anywhere on the screen and move it upwards or downwards.

Note

Constant pressure must be applied and the finger must be moved at constant speed.

- Touch ▼ or ▲ at the top or bottom of the scroll bar.
- Move the slider of the scroll bar up and down with your finger.

To return to the top of the list, touch the list title.

Note

In subsequent chapters, the operating steps for scrolling to a list item via the touch screen will be described as "...scroll to <item name>".

Scrolling pages



Note

Pages are only scrollable if there is more than one page available.

To scroll from one page to another:

- Place your finger anywhere on the screen and move it left to scroll to the next page or right to scroll to the previous page.

Note

Constant pressure must be applied and the finger must be moved at constant speed.

- Touch > or < on the screen.

Note

In subsequent chapters, the operating steps for scrolling pages via the touch screen will be described as "...scroll to...page...".

Tone settings

In the tone settings menu, the tone characteristics can be set. The menu may be accessed from each audio main menu.

To open the tone settings menu, select **Menu** in the bottom line of the respective audio main menu. If necessary, scroll through the list of menu items and select **Tone Settings**. The respective menu is displayed.

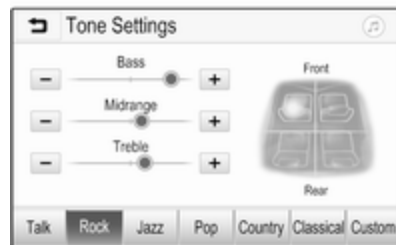

Equaliser mode

Use this setting to optimise the tone for the style of music, e.g. **Rock** or **Classical**.

Select the desired sound style in the interaction selector bar at the bottom of the screen. If you choose **Custom**, you can manually adjust the following settings.

Bass

Use this setting to enhance or attenuate the deep frequencies of the audio sources.

Touch + or - to adjust the setting.

Midrange

Use this setting to enhance or attenuate the midrange frequencies of the audio source.

Touch + or - to adjust the setting.

Treble

Use this setting to enhance or attenuate the high frequencies of the audio sources.

Touch + or - to adjust the setting.

Setting balance and fader

Use the illustration at the right side of the menu to adjust balance and fader.

To define the point in the passenger compartment where the sound is at its highest level, touch the corresponding point in the illustration. Alternatively, you can move the red marker to the desired point.

Note

The balance and fader settings are valid for all audio sources. They cannot be adjusted individually for each audio source.

Volume settings

Adjusting the maximum startup volume

Press  and then select **Settings**.

Select **Radio**, scroll through the list and then select **Max Startup Volume**.

Touch + or - to adjust the setting.

Adjusting the speed compensated volume

Press  and then select **Settings**.

Select **Radio**, scroll through the list and then select **Auto Volume**.

To adjust the degree of volume adaptation, select one of the options in the list.

Off: no enhancement of volume with increasing vehicle speed.

High: maximum enhancement of volume with increasing vehicle speed.

Activating or deactivating the audible touch feedback function

If the audible touch feedback function is activated, each touch of a screen button or menu item is indicated by a beeping sound.

Press  and then select **Settings**.

Select **Radio** and then scroll through the list to **Audible Touch Feedback**.

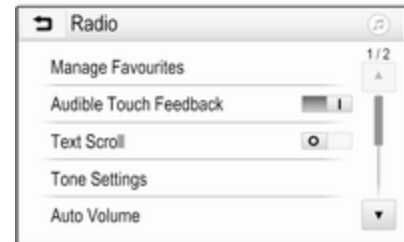

Touch the screen button next to **Audible Touch Feedback** to activate or deactivate the function.

Volume of traffic announcements

To adjust the volume of traffic announcements, set the desired volume while a traffic announcement is given out by the system. The respective setting is then stored by the system.

System settings

The following settings concern the whole system. All other settings are described by theme in the respective chapters of this manual.

Time and date settings

Press  and then select **Settings**.

Select **Time and Date** to display the respective submenu.

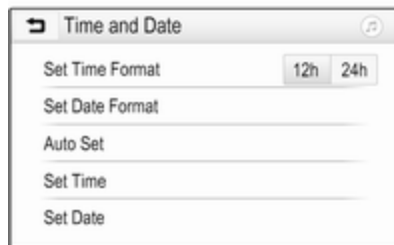

Set Time Format

To select the desired time format, touch the screen buttons **12 h** or **24 h**.

Set Date Format

To select the desired date format, select **Set Date Format** and choose between the available options in the submenu.

Auto Set

To choose whether time and date are to be set automatically or manually, select **Auto Set**.

For time and date to be set automatically, select **On - RDS**.

For time and date to be set manually, select **Off - Manual**. If **Auto Set** is set to **Off - Manual**, the submenu items **Set Time** and **Set Date** become available.

Set time and date

To adjust the time and date settings, select **Set Time** or **Set Date**.

Touch **+** and **-** to adjust the settings.

Language settings

Press  and then select **Settings**.

Select **Language** to display the respective menu.

To adjust the language for the menu texts: touch the desired language.

Text scroll function

If long text is displayed on the screen e.g. song titles or station names, the text may either be scrolled continually or it may be scrolled once and displayed in truncated form.

Press  and then select **Settings**.

Select **Radio**.

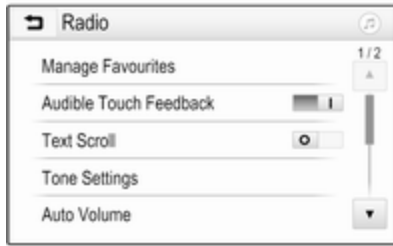

If you wish the text to be scrolled continually, activate **Text Scroll**.

If you wish the text to be scrolled in blocks, deactivate the setting.

Black display function

If you do not want to see the illuminated display, e.g. during night time, you can turn the display off.

Press and then select **Settings**.

Scroll through the list and select **Turn Display Off**. The display is turned off; the audio functions remain active.

To turn the display on again, touch the screen or press a button.

Factory defaults

Press and then select **Settings**.

Scroll through the list and select **Return to Factory Settings**.

To restore all vehicle personalisation settings, select **Restore Vehicle Settings**.

To delete the paired Bluetooth devices, the contacts list and the voice mail numbers stored, select **Clear All Private Data**.

To reset tone and volume settings, delete all favourites, and erase the ringtone selection, select **Restore Radio Settings**.

In each case, a warning message is displayed. Select **Continue** to reset the settings.

System version

Press and then select **Settings**.

Scroll through the list and select **Software Information**.

If a USB device is connected, you may save the vehicle information to this USB device.

Select **System Update** and then **Save Vehicle Info to USB**.

For a system update, contact your workshop.

Vehicle settings

Vehicle settings are described in the Owner's Manual.

Radio

Usage	104
Station search	104
Favourite lists	106
Radio data system (RDS)	107
Digital audio broadcasting	108

Usage

Activating radio

Press  and then select **AUDIO**. The audio main menu last selected is displayed.

Select **Source** in the bottom line of the active radio main menu to open the interaction selector bar.





Select the desired waveband.

The station last played in the selected waveband will be received.



Station search

Automatic station search



Briefly press or touch  or  on the control panel or on the screen to play the previous or next station in the station memory.

Manual station search

Press and hold  or  on the control panel. Release when the required frequency has almost been reached.

A search is made for the next station that can be received and it is played automatically.

Note

FM waveband: when the RDS function is activated, only RDS stations ⇨ 107 are searched for, and when the radio traffic service (TP) is activated, only traffic service stations ⇨ 107 are searched for.

Station tuning

Touch **Tune** on the screen. The **Direct tune** display is shown.



Enter the desired frequency. Use **←** to delete digits entered. If necessary, touch **◀** or **▶** to subsequently adjust the input.

Confirm the input to play the station.

Station lists

Select **Menu** in the bottom line of the active radio main menu to open the corresponding waveband-specific submenu.

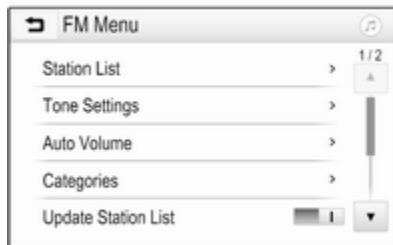

Select the waveband-specific **Station List**. All receivable stations of the relevant waveband and in the current reception area are displayed.

Select the desired station.

Note

The currently received radio station is indicated by the **▶** symbol next to the station name.

Category lists

Numerous radio stations broadcast a PTY code, which specifies the type of programme transmitted (e.g. news). Some stations also change the PTY code depending on the content which is currently transmitted.

The Infotainment system stores these stations, sorted by programme type in the corresponding category list.

Note

The **Categories** list item is only available for the FM and the DAB wavebands.

To search for a programme type determined by the stations, select **Categories**.

A list of programme types currently available is displayed.

Select the desired programme type. A list of stations is displayed transmitting a programme of the selected type.

Select the desired station.

Note

The currently received radio station is indicated by the ► symbol next to the station name.

Update station lists

If the stations stored in the waveband-specific station list can no longer be received, the AM and the DAB station lists must be updated.

Note

The FM station list is updated automatically.

Select **Menu** in the bottom line of the active radio main menu and then select **Update Station List**.

Note

If a waveband-specific station list is updated, the corresponding category list is also updated.

A station search is started and a corresponding message is displayed. Once the search is finished, the respective station list is displayed.

Note

The currently received radio station is indicated by the ► symbol next to the station name.

Favourite lists

Stations of all wavebands can be stored manually in the favourite lists.



Five favourite lists are available, in each of which five stations may be stored.

Note

The currently received station is highlighted.

Storing a station

If required, touch < or > to scroll through the favourite pages.

To store the currently active radio station to a preset screen button: touch and hold the desired screen button for a few seconds. The corresponding frequency or station name is displayed on the screen button.

Retrieving stations

If required, touch < or > to scroll to the desired favourite page.

Select the preset screen button on which the desired radio station is stored.

Defining the number of available favourites pages

To define the number of favourites pages displayed for selection, press ⚙ and then select **SETTINGS** on the screen.

Select **Radio** and then **Manage Favourites** to display the respective submenu.

Depending on which favourites pages you want to be displayed, activate or deactivate the pages.

Radio data system (RDS)

RDS is a service of FM stations that considerably facilitates the finding of the desired station and its fault-free reception.

Advantages of RDS

- On the display, the programme name of the station appears instead of its frequency.
- During a station search, the Infotainment system tunes in to RDS stations only.
- The Infotainment system always tunes into the best receivable broadcasting frequency of the set station by means of AF (alternative frequency).
- Depending on the station that is received, the Infotainment system displays radio text that can contain e.g. information on the current programme.

RDS configuration

Touch **Menu** in the bottom line of the FM radio main menu to open the corresponding waveband-specific submenu.

Scroll to **RDS**.

Activate or deactivate **RDS**.

Traffic Programme

Radio traffic service stations are RDS stations that broadcast traffic news. If the traffic service is switched on, the current audio source is interrupted for the duration of the traffic announcement.

Activating the traffic programme function

Select **Menu** in the bottom line of the FM radio main menu to open the corresponding waveband-specific submenu.

Touch the screen button next to **Traffic Programme** to activate or deactivate the function.

Note

In the station list, TP is displayed next to the stations providing a traffic programme.

If the radio traffic service is activated, **[TP]** is shown in the top line of all main menus. If the current station is not a radio traffic service station, TP is greyed-out and a search is started automatically for the next radio traffic service station. As soon as a radio traffic service station is found, **TP** is highlighted. If no radio traffic service station is found, TP remains greyed-out.

If a traffic announcement is broadcasted on the respective station, a message is displayed.

To interrupt the announcement and return to the function previously activated, touch the screen or press \odot .

Regionalisation

Sometimes RDS stations broadcast regionally different programmes on different frequencies.

Select **Menu** in the bottom line of the FM radio main menu to open the corresponding waveband-specific submenu and scroll to **Region**.

Activate or deactivate **Region**.

If regionalisation is activated, alternative frequencies with the same regional programmes are selected where necessary. If regionalisation is switched off, alternative frequencies of the stations are selected without regard to regional programmes.

Digital audio broadcasting

DAB broadcasts radio stations digitally.

DAB stations are indicated by the programme name instead of the broadcasting frequency.

General information

- With DAB, several radio programmes (services) can be broadcast on a single ensemble.
- Besides high-quality digital audio services, DAB is also able to transmit programme-associated

data and a multitude of other data services including travel and traffic information.

- As long as a given DAB receiver can pick up the signal sent out by a broadcasting station (even if the signal is very weak), sound reproduction is ensured.
- In the event of poor reception, the volume is reduced automatically to avoid the output of disagreeable noises.

If the DAB signal is too weak to be picked up by the receiver, reception is interrupted completely. This incident can be avoided by activating **DAB-DAB Linking** and/or **DAB-FM Linking** in the DAB menu (see below).

- Interference caused by stations that are on nearby frequencies (a phenomenon that is typical of AM and FM reception) does not occur with DAB.
- If the DAB signal is reflected by natural obstacles or buildings, the reception quality of DAB is

improved, whereas AM or FM reception is considerably impaired in such cases.

- When DAB reception is enabled, the FM tuner of the Infotainment system remains active in the background and continually searches for the FM stations with the best reception. If TP ⇨ 107 is activated, traffic announcements of the FM station with the best reception are issued. Deactivate TP if DAB reception should not be interrupted by FM traffic announcements.

DAB Announcements

Besides their music programmes, a lot of DAB stations also broadcast announcements of various categories. If you activate some or all categories, the currently received DAB service is interrupted when an announcement of these categories is made.

Select **Menu** in the bottom line of the DAB radio main menu to open the corresponding waveband-specific submenu.

Scroll through the list and select **DAB Announcements** to display a list of the categories available.

Activate all or just the desired announcement categories. Different announcement categories can be selected at the same time.

DAB-DAB Linking

If this function is activated, the device switches over to the same service (programme) on another DAB ensemble (if available) when the DAB signal is too weak to be picked up by the receiver.

Select **Menu** in the bottom line of the DAB radio main menu to open the corresponding waveband-specific submenu.

Scroll through the list and activate or deactivate **DAB-DAB Linking**.

DAB-FM Linking

If this function is activated, the device switches over to a corresponding FM station of the active DAB service (if available) when the DAB signal is too weak to be picked up by the receiver.

Scroll through the list and activate or deactivate **DAB-FM Linking**.

L Band

With this function, you may define which DAB wavebands are to be received by the Infotainment system.

L Band (earth and satellite radio) is another radio band that can be received additionally.

Select **Menu** in the bottom line of the DAB radio main menu to open the corresponding waveband-specific submenu.

Scroll through the list and activate or deactivate **L Band**.

Intellitext

The **Intellitext** function allows the reception of additional information such as financial information, sports, news etc.

Note

The content available depends on the station and region.

Select **Menu** in the bottom line of the DAB radio main menu to open the corresponding waveband-specific submenu.

Scroll through the list and select **Intellitext**.

Select one of the categories and choose a specific item to display detailed information.

EPG

The Electronic Programme Guide provides information on the current and upcoming programme of the respective DAB station.

Select **Menu** in the bottom line of the DAB radio main menu and then select **Station List**.

To display the programme of the desired station, touch the icon next to the station.

External devices

General information	110
Playing audio	112
Displaying pictures	113
Playing movies	114
Using smartphone applications .	115

General information

A USB port for the connection of external devices is located in the centre console behind the parking brake or underneath the armrest.

Two USB ports for charging devices only are located at the rear of the centre console.

Note

The USB port must always be kept clean and dry.

USB port

An MP3 player, USB drive, SD card (via USB connector/adaptor) or smartphone can be connected to the USB port.

Up to two USB devices can be connected to the Infotainment system at a time.

Note

For the connection of two USB devices, an external USB hub is required.

The Infotainment system can play audio files, show picture files or play movie files contained in USB storage devices.

When connected to the USB port, various functions of the devices mentioned above can be operated via the controls and menus of the Infotainment system.

Note

Not all auxiliary devices are supported by the Infotainment system. Check the compatibility list on our website.

Connecting/disconnecting a device

Connect one of the devices mentioned above to the USB port. If required, use the appropriate connection cable. The music function starts automatically.

Note

If a non-readable USB device is connected, a corresponding error message appears and the Infotainment system automatically switches to the previous function.

To disconnect the USB device, select another function and then remove the USB storage device.

Caution

Avoid disconnecting the device during playback. This may damage the device or the Infotainment system.

USB Auto Launch

By default, the USB audio menu is displayed automatically as soon as a USB device is connected.

If desired, this function can be deactivated.

Press  and then select **Settings** to open the settings menu.

Select **Radio**, scroll to **USB Auto Launch** and touch the screen button next to the function.

To reactivate the function, touch the screen button again.

Bluetooth

Devices which support the Bluetooth music profiles A2DP and AVRCP can be connected wirelessly to the Infotainment system. The Infotainment system can play music files contained in these devices.

Connecting a device

For a detailed description on how to establish a Bluetooth connection  119.

File formats and folders

The maximum capacity of a device supported by the Infotainment system amounts to 2500 music files, 2500 picture files, 250 movie files, 2500 folders and 10 stages of folder structure. Only devices formatted in the FAT16/FAT32 file system are supported.

If there are images included in the audio metadata, these images are displayed on the screen.

Note

Some files may not be played properly. This may be due to a different recording format or the condition of the file.

Files from online shops to which Digital Rights Management (DRM) has been applied cannot be played.

The Infotainment system can play the following audio, picture and movie files stored on external devices.

Audio files

The playable audio file formats are MP3 (MPEG-1 Layer 3, MPEG-2 Layer 3), WMA, AAC, AAC+, ALAC OGG WAF (PCM), AIFF, 3GPP (audio only), Audio Books and LPCM. iPod® and iPhone® devices play ALAC, AIFF, Audio Books and LPCM. When playing a file with ID3 tag information, the Infotainment system can display information, e.g. on the track title and artist.

Picture files

The displayable picture file formats are JPG, JPEG, BMP, PNG and GIF.

JPG files must be 64 to 5000 pixels in width and 64 to 5000 pixels in height.

BMP, PNG and GIF files must be 64 to 1024 pixels in width and 64 to 1024 pixels in height.

The pictures should not exceed a file size of 1MB.

Movie files

The playable movie file formats are AVI and MP4.

The maximum resolution is 1280 x 720 pixels. The frame rate must be less than 30 fps.

The usable codec is H.264/MPEG-4 AVC.

The playable audio formats are MP3, AC3, AAC and WMA.

The displayable subtitle format is SMI.

Playing audio

Activating the music function

If the device is not yet connected to the Infotainment system, connect the device ↗ 110.

Usually, the respective audio main menu is displayed automatically.

If playback is not started automatically, e.g. if **USB Auto Launch** is deactivated ↗ 110, take the following steps:

Press  and then select **AUDIO** to open the audio main menu last selected.

Select **Source** in the interaction selector bar and then select the desired audio source to open the respective audio main menu.

Playback of the audio tracks starts automatically.



Function buttons

Interrupting and resuming playback

Touch **II** to interrupt playback. The screen button changes to **▶**.

Touch **▶** to resume playback.

Playing the next or previous track

Touch **▶▶** to play the next track.

Touch **◀◀** within the first two seconds of the track playing to return to the previous track.

Returning to the beginning of the current track

Touch **◀◀** after two seconds of the track playing.

Fast forwarding and rewinding

Touch and hold **◀◀** or **▶▶**. Release to return to normal playback mode.

Alternatively, you can move the slider showing the current track position to the left or right.

Playing tracks randomly

Touch **⌘** to play the tracks in random order. The screen button changes to **⌘**.

Touch \times again to deactivate the shuffle function and go back to the normal playback mode.

Browse Music function

To display the browse screen, touch the screen. Alternatively, select **Menu** in the bottom line of the audio main screen to display the respective audio menu and then select **Browse Music**.

Different categories, in which the tracks are sorted, are displayed, e.g. **Playlists**, **Artists**, or **Albums**.

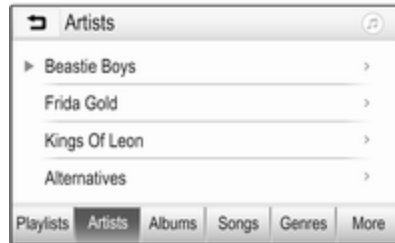

Select the desired category, subcategory (if available) and then choose a track.

Select the track to start playback.

Displaying pictures

You can view pictures from a USB device connected to the USB port.

Note

For your safety, some features are disabled while driving.

Activating the picture function

If the device is not yet connected to the Infotainment system, connect the device \rightarrow 110.

Press \mathcal{A} and then select **GALLERY** to open the media main menu.

Touch \mathcal{A} to open the picture main menu to display a list of items stored on the USB device. Select the desired picture.



Touch the screen to hide the menu bar. Touch the screen again to redisplay the menu bar.

Function buttons

Full screen mode

Select \mathcal{A} to display the picture in full screen mode. Touch the screen to exit full screen mode.

Viewing the next or previous picture

Touch \rangle or swipe to the left to view the next picture.

Touch \langle or swipe to the right to view the previous picture.

Rotating a picture

Select  to rotate the picture.

Zoom in on a picture

Touch  once or several times to zoom in on a picture or to return to its original size.

Viewing a slide show

Select  to view the pictures stored on the USB device in a slide show.

Touch the screen to end the slide show.

Picture menu

Select **Menu** in the bottom line of the screen to display the **Picture Menu**.

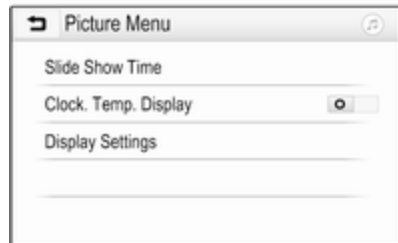

Slide show time

Select **Slide Show Time** to display a list of possible time sequences. Activate the desired time sequence in which one picture is to be displayed in a slide show.

Clock and temperature display

To display time and temperature in full screen mode, activate **Clock. Temp. Display**.

Display settings

Select **Display Settings** to open a submenu for the adjustment of brightness and contrast.

Touch + or - to adjust the settings.

Playing movies

You can view movies from a USB device connected to the USB port.

Note

For your safety, the movie function is not available while driving.

Activating the movie function

If the device is not yet connected to the Infotainment system, connect the device  110.

Press  and then select **GALLERY** to open the media main menu.

Touch  to open the movie main menu and then select the desired folder and/or movie.

The movie is shown.



Function buttons

Full screen

Select  to display the movie in full screen mode. Touch the screen to exit full screen mode.

Interrupting and resuming playback

Touch **II** to interrupt playback. The screen button changes to **▶**.

Touch ► to resume playback.

Playing the next or previous track

Touch ►| to play the next movie file.

Touch ◀| within the first five seconds of the movie playing to return to the previous movie file.

Returning to the beginning of the current movie

Touch ◀ after five seconds of the movie playing.

Fast forwarding and rewinding

Touch and hold ◀ or ►|. Release to return to normal playback mode.

Movie menu

Select **Menu** in the bottom line of the screen to display the **Movie Menu**.



Clock and temperature display

To display time and temperature in full screen mode, activate **Clock. Temp. Display**.

Display settings

Select **Display Settings** to open a submenu for adjustment of brightness and contrast.

Touch + and - to adjust the settings.

Using smartphone applications

Phone projection

The phone projection applications Apple CarPlay™ and Android™ Auto display selected apps from your smartphone on the Infotainment screen and allow their operation directly via the Infotainment controls.

Check with the device's manufacturer if this function is compatible with your smartphone and if this application is available in the country you are in.

Preparing the smartphone

Android phone: Download the Android Auto app to your smartphone from the Google Play™ Store.

iPhone: Make sure Siri® is activated on your smartphone.

Activating phone projection in the settings menu

Press ⌘ to display the home screen and then select **SETTINGS**.

Scroll through the list to **Apple CarPlay** or **Android Auto**.

Make sure the respective application is activated.

Connecting the mobile phone

Connect the smartphone to the USB port ↗ 110.

Starting phone projection

To start the phone projection function, press  and then select **PROJECTION**.

Note

If the application is recognised by the Infotainment system, the application icon may change to **Apple CarPlay** or **Android Auto**.

To start the function, you can alternatively press and hold  for a few seconds.

The phone projection screen displayed depends on your smartphone and software version.

Returning to the Infotainment screen

Press .

BringGo

BringGo is a navigation app providing location search, map display and route guidance.

Downloading the app

Before BringGo can be operated using the controls and menus of the Infotainment system, the respective application must be installed on the smartphone.

Download the app from App Store® or Google Play Store.

Activating phone projection in the settings menu

Press  to display the home screen and then select **SETTINGS**.

Scroll through the list to **BringGo**.

Make sure the application is activated.

Connecting the mobile phone

Connect the smartphone to the USB port ↗ 110.

Starting BringGo

To start the app, press  and then select the navigation icon.

The main menu of the application is shown on the display of the Infotainment system.

For further information on how to operate the app, see the instructions on the manufacturer's website.

Speech recognition

General information	117
Usage	117



General information

The voice pass-thru application of the Infotainment system allows access to the speech recognition commands on your smartphone. See your smartphone manufacturer's operating instructions to find out whether your smartphone supports this feature.

In order to use the voice pass-thru application, the smartphone must be connected to the Infotainment system via USB cable ↻ 110 or via Bluetooth ↻ 119.

Usage

Activating speech recognition

Press and hold  on the control panel or  on the steering wheel to start a speech recognition session. A voice command message is displayed on the screen.

As soon as a beep is heard, you can say a command. For information on the commands supported, see the operating instructions for your smartphone.

Adjusting the volume of voice prompts

Turn  on the control panel or press **+** / **-** on the right side of the steering wheel to increase or decrease the volume of voice prompts.

Deactivating speech recognition

Press  on the steering wheel. The voice command message disappears and the speech recognition session is ended.

Phone

General information	118
Bluetooth connection	119
Emergency call	121
Operation	122
Mobile phones and CB radio equipment	126

General information

The phone portal provides you with the possibility of having mobile phone conversations via a vehicle microphone and the vehicle loudspeakers as well as operating the most important mobile phone functions via the Infotainment system in the vehicle. To be able to use the phone portal, the mobile phone must be connected to the Infotainment system via Bluetooth.

Not all phone functions are supported by every mobile phone. The usable phone functions depend on the relevant mobile phone and network provider. You can find further information on this in the operating instructions for your mobile phone, or you can enquire about them with your network provider.

Important information for operation and traffic safety

Warning

Mobile phones have effects on your environment. For this reason safety regulations and directions have been prepared. You should be familiar with the related directions before you use the telephone function.

Warning

Use of the hands-free facility while driving can be dangerous because your concentration is reduced when telephoning. Park your vehicle before you use the hands-free facility. Follow the stipulations of the country in which you find yourself at present.

Do not forget to follow the special regulations that apply in specific areas and always switch off the mobile phone if the use of mobile phones is prohibited, if

interference is caused by the mobile phone or if dangerous situations can occur.

Bluetooth

The phone portal is certified by the Bluetooth Special Interest Group (SIG).

You can find further information about the specification on the internet at <http://www.bluetooth.com>

Bluetooth connection

Bluetooth is a radio standard for the wireless connection of e.g. mobile phones, smartphones or other devices.

The pairing (PIN code exchange between Bluetooth device and Infotainment system) and connecting of the Bluetooth devices to the Infotainment system are carried out via the **Bluetooth** menu.

Bluetooth menu

Press  and then select **SETTINGS**.

Select **Bluetooth** to display the Bluetooth menu.

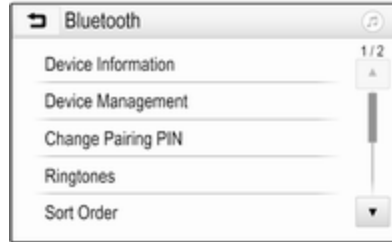

Pairing a device

Important information

- Up to ten devices can be paired to the system.
- Only one paired device can be connected to the Infotainment system at a time.
- Pairing only needs to be carried out once, unless the device is deleted from the list of paired devices. If the device has been

connected previously, the Infotainment system establishes the connection automatically.

- Bluetooth operation considerably drains the device's battery. Therefore, connect the device to the USB port for charging.

Pairing a new device

1. Activate the Bluetooth function of the Bluetooth device. For further information, see the operating instructions for the Bluetooth device.
2. Press  and then select **SETTINGS** on the Info-Display. Select **Bluetooth** and then **Device Management** to display the respective menu.



Note

If no phone is connected, the **Device Management** menu can also be accessed via the phone menu: Press and then select **PHONE**.

3. Touch **Search Device**. All discoverable Bluetooth devices in the environment are displayed in a new search list.
4. Touch the Bluetooth device you wish to pair.
5. Confirm the pairing procedure:
 - If SSP (secure simple pairing) is supported:

Confirm the messages on the Infotainment system and the Bluetooth device.

- If SSP (secure simple pairing) is not supported:

On the Infotainment system: an **Info** message is displayed asking you to enter a PIN code on your Bluetooth device.

On the Bluetooth device: enter the PIN code and confirm your input.

6. The Infotainment system and the device are paired.

Note

If the Bluetooth device is successfully paired, next to the Bluetooth device indicates that the phone function is enabled and indicates that the Bluetooth music function is enabled.

7. The phone book is downloaded automatically to the Infotainment system. Depending on the phone, the Infotainment system must be allowed access to the phone book. If required, confirm the

messages displayed on the Bluetooth device.

If this function is not supported by the Bluetooth device, a corresponding message is displayed.

Changing the Bluetooth PIN code

Press and then select **SETTINGS**.

Select **Bluetooth** and then **Change Pairing PIN** to display the respective submenu. A keypad is displayed.

Enter the desired four-digit PIN code.

To delete an entered number, select .

Confirm your input by selecting **Enter**.

Connecting a paired device

Press and then select **SETTINGS**.

Select **Bluetooth** and then **Device Management** to display the respective menu.

Select the Bluetooth device you wish to connect. The device is connected.

Note

The connected device and the available options are highlighted.

Disconnecting a device

Press  and then select **SETTINGS**.

Select **Bluetooth** and then **Device Management** to display the respective menu.

Select the Bluetooth device currently connected. You are prompted with a message.

Select **Yes** to disconnect the device.

Deleting a device

Press  and then select **SETTINGS**.

Select **Bluetooth** and then **Device Management** to display the respective menu.

Select **DEL** next to the Bluetooth device. You are prompted with a message.

Select **Yes** to delete the device.

Device info

Press  and then select **SETTINGS**.

Select **Bluetooth** and then **Device Information** to display the respective menu.

The information displayed includes **Device Name**, **Address**, and **PIN Code**.

Emergency call

Warning

Connection setup cannot be guaranteed in all situations. For this reason you should not rely exclusively on a mobile phone when a vitally important communication (e.g. a medical emergency) is concerned.

In some networks it may be necessary for a valid SIM card to be properly inserted in the mobile phone.

Warning

Bear in mind that you can make and receive calls with the mobile phone if it is in a service area with a sufficiently strong signal. Under certain circumstances, emergency calls cannot be made

on all mobile phone networks; it is possible that they cannot be made when certain network services and/or telephone functions are active. You can enquire about this with the local network operators.

The emergency call number can differ depending on the region and country. Please enquire beforehand about the correct emergency call number for the relevant region.

Making an emergency call

Dial the emergency call number (e.g. **112**).

The telephone connection to the emergency call centre is set up.

Answer when the service personnel questions you about the emergency.

Warning

Do not end the call until you are requested to do so by the emergency call centre.

Operation

As soon as a connection via Bluetooth has been set up between your mobile phone and the Infotainment system, you can operate many functions of your mobile phone via the Infotainment system.

Note

In the hands-free mode, mobile phone operation continues to be possible, e.g. taking a call or adjusting the volume.

After setup of a connection between the mobile phone and the Infotainment system, mobile phone data is transmitted to the Infotainment system. This can take some time depending on the mobile phone and the amount of data to be transferred. During this period, operation of the mobile phone via the Infotainment system is possible only to a limited extent.

Note

Not every mobile phone supports all functions of the phone portal. Therefore, deviations from the range of functions described below are possible.

Phone main menu

Press  and then select **PHONE** to display the respective menu.



Note

The **PHONE** main menu is only available if a mobile phone is connected to the Infotainment system via Bluetooth. For a detailed description  119.

Many functions of the mobile phone can now be controlled via the phone main menu (and associated submenus), and via the phone-specific controls on the steering wheel.



Initiating a phone call

Entering a phone number

Press  and then select **PHONE**.

Enter a telephone number using the keypad in the phone main menu.

To delete one or more entered characters, touch or touch and hold .

Touch  on the screen or press  on the steering wheel to start dialling.

Using the phone book

Note

When pairing a mobile phone with the Infotainment system via Bluetooth, the phone book of the mobile phone is downloaded automatically  119.

Press  and then select **PHONE**.

Select **Contacts** in the phone main menu.



Quick search

1. Select **⌘** to display a list of all contacts.
2. Scroll through the list of contacts entries.
3. Touch the contact you wish to call. A menu with all phone numbers stored for the selected contact is displayed.
4. Select the desired phone number to initiate the call.

Search menu

If the phone book contains a large number of entries, you can search for the desired contact via the search menu.

Select **🔍** in the **Contacts** menu to display the search tab.



The letters are organised in alphabetical groups on the screen buttons: **abc**, **def**, **ghi**, **jkl**, **mno**, **pqrs**, **tuv**, and **wxyz**.

Use **⌘** to delete an entered group of letters.

1. Select the button containing the first letter of the contact you wish to search for.

For example: If the contact you wish to search for starts with 'g' select the **ghi** screen button.

All contacts containing one of the letters on this button, in the example 'g', 'h', and 'i', are displayed.

2. Select the button containing the second letter of the contact you wish to search for.
3. Continue to enter more letters of the contact you wish to search for until the desired contact is displayed.
4. Touch the contact you wish to call. A menu with all phone numbers stored for the selected contact is displayed.
5. Select the desired phone number to initiate the call. The following display is shown.



Contacts settings

The contacts list can be sorted by last name or first name.

Press and then select **SETTINGS** to display the respective menu.

Select **Bluetooth** and then **Sort Order**. Activate the desired option.

Using the call history

All incoming, outgoing, or missed calls are registered.

Press and then select **PHONE**.

Select **Call History** in the phone main menu.



Select for outgoing calls, for missed calls, for incoming calls and for all calls. The respective call list is displayed.

Select the desired entry to initiate a call.

Redialling a number

The last dialled phone number can be redialled.

Press and then select **PHONE**.

Select on the screen or press on the steering wheel.

Using speed dial numbers

Speed dial numbers that are stored on the mobile phone can also be dialled using the keypad of the phone main menu.

Press and then select **PHONE**.

Touch and hold the respective digit on the keypad to initiate the call.



Incoming phone call

Taking a call



If an audio mode, e.g. the radio or USB mode, is active at the moment a call comes in, the audio source is muted and stays muted until the call ends.

A message with the caller's phone number or name (if available) is displayed.



To answer the call, select  in the message or press  on the steering wheel.

Rejecting a call

To reject the call, select  in the message or press  on the steering wheel.

Changing the ring tone

Press  and then select **SETTINGS**. Select **Bluetooth** and then **Ringtones** to display the respective menu. A list of all devices paired is displayed. Select the desired device. A list of all ringtones available for this device is displayed.

Select one of the ringtones.

Functions during a call

During an ongoing phone call the phone main menu is displayed.



Deactivating the hands-free mode temporarily

To continue the conversation via the mobile phone, activate .

To return to the hands-free mode, deactivate .

Deactivating the microphone temporarily

To mute the microphone, activate .

To reactivate the microphone, deactivate .

Ending a phone call

Select  to end the call.

Voice mail box

You may operate your voice mail box via the Infotainment system.

Voice mail number

Press  and then select **SETTINGS**.

Select **Bluetooth**. Scroll through the list and select **Voice Mail Numbers**.

A list of all paired devices is displayed.

Select the respective phone. A keypad is displayed.

Enter the voice mail number for the respective phone.

Calling the voice mail box

Press  and then select **PHONE**.

Select  on the screen. The mail box is called.

Alternatively, enter the voice mail number via the phone keypad.

Mobile phones and CB radio equipment

Installation instructions and operating guidelines

The vehicle specific installation instructions and the operating guidelines of the mobile phone and hands-free manufacturer must be observed when installing and operating a mobile telephone. Failure to do so could invalidate the vehicle type approval (EU directive 95/54/EC).

Recommendations for fault-free operation:

- Professionally installed exterior antenna to obtain the maximum range possible
- Maximum transmission power 10 watts
- Installation of the phone in a suitable spot, consider relevant Note in the Owner's Manual, section **Airbag system**.

Seek advice on predetermined installation points for the external antenna or equipment holder and

ways of using devices with a transmission power exceeding 10 watts.

Use of a hands-free attachment without external antenna with mobile telephone standards GSM 900/1800/1900 and UMTS is only permitted if the maximum transmission power of the mobile telephone is 2 watts for GSM 900 or 1 watt for the other types.

For reasons of safety, do not use the phone while driving. Even use of a hands-free set can be a distraction while driving.

Warning

Operation of radio equipment and mobile telephones which fail to meet above mentioned mobile telephone standards is only permitted using an antenna located outside of the vehicle.

Caution

Mobile telephones and radio equipment may lead to malfunctions in the vehicle electronics when operated inside the vehicle with no exterior antenna, unless the above mentioned regulations are observed.

Index

- A**
- Activating Bluetooth music..... 112
 - Activating phone..... 122
 - Activating radio..... 104
 - Activating USB audio..... 112
 - Activating USB movie..... 114
 - Activating USB picture..... 113
 - Audio files..... 110
 - Auto volume..... 101
- B**
- Basic operation..... 98
 - Bluetooth
 - Bluetooth connection..... 119
 - Bluetooth music menu..... 112
 - Connecting device..... 110
 - General information..... 110
 - Pairing..... 119
 - Phone..... 122
 - Bluetooth connection..... 119
 - BringGo..... 115
- C**
- Call
 - Functions during a call..... 122
 - Incoming call..... 122
 - Initiating a phone call..... 122
 - Ring tone..... 122
 - Call history..... 122
- Control elements**
- Infotainment system..... 92
 - Steering wheel..... 92
- Control elements overview..... 92
- D**
- DAB..... 108
 - Digital audio broadcasting..... 108
 - Displaying pictures..... 113
 - Display settings..... 113, 114
- E**
- Emergency call..... 121
- F**
- Favourite lists..... 106
 - Retrieving stations..... 106
 - Storing stations..... 106
 - File formats
 - Audio files..... 110
 - Movie files..... 110
 - Picture files..... 110
- G**
- General information.... 110, 117, 118
 - Bluetooth..... 110
 - DAB..... 108
 - Infotainment system..... 90
 - Phone..... 118
 - Smartphone applications..... 110
 - USB..... 110

H			
Home menu.....	98		
I			
Infotainment control panel.....	92		
Intellitext.....	108		
M			
Maximum startup volume.....	101		
Menu operation.....	98		
Mobile phones and CB radio equipment	126		
Movie files.....	110		
Mute.....	95		
O			
Operation.....	122		
External devices.....	110		
Menu.....	98		
Phone.....	122		
Radio.....	104		
P			
Pairing.....	119		
Phone			
Bluetooth.....	118		
Bluetooth connection.....	119		
Call history.....	122		
Emergency calls.....	121		
Entering a number.....	122		
Functions during a call.....	122		
General information.....	118		
Incoming call.....	122		
Phone book.....	122		
Phone main menu.....	122		
Selecting the ring tone.....	122		
Speed dial number.....	122		
Phone book.....	122		
Phone projection.....	115		
Picture files.....	110		
Playing audio.....	112		
Playing movies.....	114		
R			
Radio			
Activating.....	104		
Configuring DAB.....	108		
Configuring RDS.....	107		
DAB announcements.....	108		
Digital audio broadcasting (DAB).....	108		
Favourite lists.....	106		
Intellitext.....	108		
Radio data system (RDS).....	107		
Regional.....	107		
Regionalisation.....	107		
Retrieving stations.....	106		
Selecting the waveband.....	104		
Station search.....	104		
Station tuning.....	104		
Storing stations.....	106		
Usage.....	104		
Radio data system (RDS)	107		
RDS.....	107		
Regional.....	107		
Regionalisation.....	107		
Retrieving stations.....	106		
Ring tone			
Changing the ring tone.....	122		
Ring tone volume.....	101		
S			
Smartphone.....	110		
Phone projection.....	115		
Speech recognition.....	117		
Speed dial numbers.....	122		
Station search.....	104		
Steering wheel audio controls.....	92		
Storing stations.....	106		
Switching the Infotainment system on.....	95		
System settings.....	102		
T			
Theft-deterrent feature	91		
Tone settings.....	100		
Touch beep volume.....	101		
TP volume.....	101		

U

Usage.....	95, 104, 117
Bluetooth.....	110
Menu.....	98
Phone.....	122
Radio.....	104
USB.....	110
USB	
Connecting device.....	110
General information.....	110
USB audio menu.....	112
USB movie menu.....	114
USB picture menu.....	113
Using smartphone applications. .	115

V

Voice recognition.....	117
Volume	
Auto volume.....	101
Maximum startup volume.....	101
Mute function.....	95
Ring tone volume.....	101
Setting the volume.....	95
Speed compensated volume. .	101
Touch beep volume.....	101
TP volume.....	101
Volume limitation at high temperatures.....	95
Volume settings.....	101

W

Waveband selection.....	104
-------------------------	-----

R300 BT

Introduction	132
Basic operation	138
Radio	142
External devices	147
Speech recognition	150
Phone	151
Index	158

Introduction

General information	132
Theft-deterrent feature	133
Control elements overview	134
Usage	136

General information

The Infotainment system provides you with state-of-the-art in-car infotainment.

Using the FM, AM or DAB radio functions, you can register a large number of stations on different favourites pages.

You can connect external data storage devices to the Infotainment system as further audio sources; either via a cable or via Bluetooth®.

The digital sound processor provides you with several preset equaliser modes for sound optimisation.

In addition, the Infotainment system is equipped with a Phone portal that allows comfortable and safe use of your mobile phone in the vehicle.

Optionally, the Infotainment system can be operated using the control panel or the controls on the steering wheel, or - if provided by your mobile phone - via speech recognition.

Note

This manual describes all options and features available for the various Infotainment systems.

Certain descriptions, including those for display and menu functions, may not apply to your vehicle due to model variant, country specifications, special equipment or accessories.

Important information on operation and traffic safety

Warning

Drive safely at all times when using the Infotainment system.

If in doubt, stop the vehicle before operating the Infotainment system.

Radio reception

Radio reception may be disrupted by static, noise, distortion or loss of reception due to:

- changes in distance from the transmitter
- multi-path reception due to reflection
- shadowing

Theft-deterrent feature



The Infotainment system is equipped with an electronic security system for the purpose of theft deterrence.

The Infotainment system therefore functions only in your vehicle and is worthless to a thief.

Control elements overview

Control panel



1		136
	If switched off: short press: switch power on	
	If switched on: short press: mute system; long press: switch power off	
	Turn: adjust volume	
2	RADIO	
	Activate radio or change waveband	142
3	MEDIA	
	Activate media or change media source	148
4	 	
	Radio: short press: skip to previous or next station; press and hold: seek down or up	
		142
	External devices: short press: skip to previous or next track; press and hold: rewind or fast forward	
		148

5	PHONE	
	Short press: open phone menu	151
	Long press: activate speech recognition	150
6	BACK	
	Menu: one level back	138
	Input: delete last character or entire entry	138
7	MENU	138
	Turn: mark screen buttons or menu items; set numeric values	
	Press: select/activate a marked screen button or menu item; confirm set value; switch to different setting option; open application-specific menu (if available)	

8	Softkeys	
	Favourites: press: select favourites; press and hold: save radio stations as favourites	143
	Menu: press: select corresponding screen button	138
9	FAV	
	Press: display favourites bar	143

Steering wheel audio controls

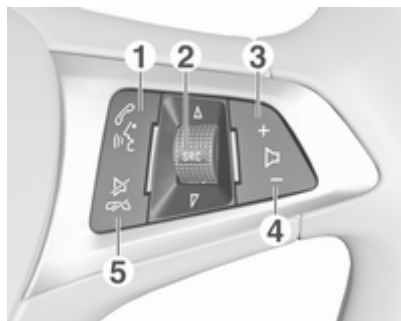

- 1**
 Short press: accept phone call 151
 or dial number in call list 154
 With Phone portal active and calls waiting: short press: switch between calls 154
 Long press: activate speech recognition 150
- 2** **SRC** (Source) 136
 Press: select audio source .. 136

With radio active: turn upwards/downwards to select next/previous preset radio station 142

With Phone portal active and call list open: turn upwards/downwards to select next/previous entry in call list 154

- 3** +
 Increase volume 136
- 4** -
 Reduce volume 136
- 5**
 Short press: end/decline call 154
 or close call list 154
 or deactivate speech recognition 150
 or activate/deactivate mute . 136

Usage

Control elements

The Infotainment system is operated via function buttons, a **MENU** knob and menus that are shown on the display.

Inputs are made optionally via:

- the control panel on the Infotainment system ↗ 134
- audio controls on the steering wheel ↗ 134
- the speech recognition ↗ 150

Switching the Infotainment system on or off

Press briefly. After switching on, the last selected Infotainment source becomes active.

Press and hold again to switch the system off.

Automatic switch-off

If the Infotainment system is switched on by pressing while the ignition is switched off, it switches off again automatically after 10 minutes.

Setting the volume

Turn \odot ; the current setting is shown on the display.

When the Infotainment system is switched on, the last selected volume is set, provided that the volume is lower than the maximum start-up volume \rightarrow 139.

Speed compensated volume

When Auto volume is activated \rightarrow 139, the volume is adapted automatically to make up for the road and wind noises as you drive.

Mute function

Press \odot to mute the audio sources.
To cancel the mute function: turn \odot .

Modes of operation

Radio

Press **RADIO** to open the radio main menu or to toggle between the different wavebands.

For a detailed description of the radio functions \rightarrow 142.

External devices

Press **MEDIA** repeatedly to activate the playback mode for a connected external device (e.g. USB device, Bluetooth device).

For a detailed description on connecting and operating external devices \rightarrow 147.

Phone

Press **PHONE** to establish a Bluetooth connection between the Infotainment system and a mobile phone.

If a connection can be established, the main menu of the phone mode is displayed.

For a detailed description of mobile phone operation via the Infotainment system \rightarrow 154.

If no connection can be established, a corresponding menu is displayed.

For a detailed description of preparing and establishing a Bluetooth connection between the Infotainment system and a mobile phone \rightarrow 152.

Basic operation

Basic operation	138
Tone settings	138
Volume settings	139
System settings	139

Basic operation

Control panel

MENU knob

The **MENU** knob is one of the central control elements for menu operation.

Turn:

- to select a screen button or menu item
- to scroll through a list of menu items
- to change a settings value

Press:

- to activate a selected screen button or menu item
- to confirm a changed settings value
- to switch to a different settings option
- to display the application-specific submenu

Note

In subsequent chapters, the operating steps for selecting and activating a screen button or menu item will be described as "...select <button name>/<item name>".

BACK button

When operating the menus, press **BACK** to return to the next higher menu level.

When entering digits, press **BACK** to delete the last character entered.

Softkeys

Press one of the softkeys to activate the favourite or function screen button displayed immediately above the respective softkey.

Note

In subsequent chapters, the operating steps for selecting and activating a screen button or menu item will be described as "...select <button name>/<item name>".

Tone settings

In the tone settings menu, the tone characteristics can be set differently for each audio source.

Press **MENU**, select **Settings** and then select **Tone Settings** to open the tone settings menu.

Setting bass, midrange, and treble

Scroll through the list and select **Bass**, **Midrange** or **Treble**.

Adjust the setting and confirm.

Setting the volume distribution between front and rear

Scroll through the list and select **Fader**.

Adjust the setting and confirm.

Setting the volume distribution between right and left

Scroll through the list and select **Balance**.

Adjust the setting and confirm.

Selecting a tone style

Scroll through the list and select **EQ** (Equaliser).

The EQ options offer optimised bass, middle, and treble presets for the relevant style of music.

Turn **MENU** to toggle through the different options and then press **MENU** to confirm the setting.

Volume settings

Adjusting the speed compensated volume

Press **MENU** to open the respective audio menu.

Scroll through the list and select **Settings**.

Select **Auto Volume Control**.

The **Auto Volume** function can be deactivated or the degree of volume adaptation can be selected in the menu displayed.

Scroll through the list and select the desired option.

Adjusting the maximum startup volume

Press **MENU** to open the respective audio menu.

Scroll through the list and select **Settings**.

Select **Maximum Startup Volume**.

Set the desired value.

Volume of traffic announcements

To adjust the volume of traffic announcements, set the desired volume while a traffic announcement is given out by the system.

The respective setting is stored by the system.

System settings

Various settings and adaptations for the Infotainment system can be performed via the settings menu.

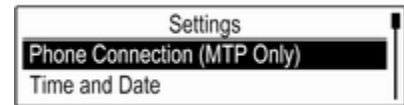

Time and date settings

Press **MENU** to open the respective audio menu.

Select **Time and Date**.

Set Time

Select **Set Time** to enter the respective submenu.

Select **Auto Set** at the bottom of the screen. Activate either **On - RDS** or **Off (Manual)**.

If **Off (Manual)** is selected, adjust hours and minutes.

Repeatedly select **12-24 HR** at the bottom of the screen to choose a time mode.

If the 12-hour mode is selected, a third column for AM and PM selection is displayed. Select the desired option.

Set Date

Select **Set Date** to enter the respective submenu.

Select **Auto Set** at the bottom of the screen. Activate either **On - RDS** or **Off (Manual)**.

If **Off (Manual)** is selected, adjust the date settings.

Language

Press **MENU** to open the respective audio menu.

Select **Settings**, scroll through the list and select **Vehicle Settings**.

Select **Languages**.

Scroll through the list and select the desired language.

Restore Factory Settings

Press **MENU** to open the respective audio menu.

Select **Settings**, scroll through the list and select **Vehicle Settings**.

Select **Restore Factory Settings** to enter the respective submenu.

Select the desired option and confirm the message.

Software Information

The **Software Information** menu contains specific information on the software.

Press **MENU** to open the respective audio menu.

Select **Settings**, scroll through the list and select **Vehicle Settings**.

Select **Software Information**.

Valet mode

If valet mode is activated, all vehicle displays are locked and no changes may be performed within the system.

Note

Vehicle-related messages remain enabled.

Locking the system

Press **MENU** to open the respective audio menu.

Select **Settings**, scroll through the list and select **Vehicle Settings**.

Select **Valet Mode**. A keypad is displayed.

Enter a four-digit code and select **Enter**. The keypad is redisplayed.

To confirm the first input, reenter the four-digit code and select **Lock**. The system is locked.

Unlocking the system

Turn the Infotainment system on. A keypad is displayed.

Enter the respective four-digit code and select **Unlock**. The system is unlocked.

Forgotten PIN code

To reset the PIN code to the default setting, contact your workshop.

Radio

Usage	142
Station search	142
Favourite lists	143
Radio data system (RDS)	143
Digital audio broadcasting	144

Usage



Activating the radio function

Press **RADIO**.

Selecting the waveband

Repeatedly press **RADIO** on the control panel to toggle between the different wavebands.

Station search

Automatic station search

Press **◀** or **▶** to play the previous or next station.

Manual station search

Press and hold **◀** or **▶**. Release the button when the required frequency has almost been reached.

Manual tuning

Press **MENU** to open the waveband menu and then select **Manual Tuning**.

Depending on the waveband selected, a list of all frequencies is displayed.

Select the desired frequency.

Station lists

Turn **MENU** to display a list of all stations currently receivable.

Scroll through the list and select the desired station.

Category lists

Numerous RDS ⇨ 143 and DAB ⇨ 144 stations broadcast a PTY code, which specifies the type of programme transmitted (e.g. news). Some stations also change the PTY code depending on the content which is currently transmitted.

The Infotainment system stores these stations, sorted by programme type in the corresponding category list.

Note

The **Categories** list item is only available for the FM and the DAB wavebands.

Press **MENU** to display the respective waveband menu and select **Categories**.

A list of programme type categories currently available is displayed.

Select the desired category. A list of stations is displayed transmitting a programme of the selected type.

Select the desired station.

Updating the station lists

Press **MENU** to open the waveband menu and select **Update Station List**. The respective station list is updated.

Note

If a waveband-specific station list is updated, the corresponding category list is also updated.

Favourite lists

Stations of all wavebands can be stored manually in the favourite lists.

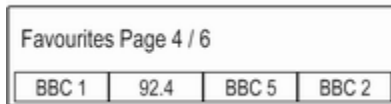

24 individual favourite locations are available, displayed in four favourites per favourites page.

To display the favourites list, select **FAV**.

Storing a station

Set the station to be stored.

Select and hold the respective favourite screen button until a beeping sound is given out and the station name is displayed on the respective favourites screen button.

The station is stored as a favourite.

Retrieving a station

If necessary, repeatedly press **FAV** to scroll to the respective favourites page.

Select the desired favourite screen button. The respective radio station is played.

Note

The active favourite is highlighted.

Defining the number of favourites shown

Press **MENU**, scroll through the list and select **Set Number of Favourite Pages**.

Select the desired option.

Note

If the number of favourites stored exceeds the number of favourites activated in the settings menu, the additionally stored favourites are not deleted but just hidden from view. They may be reactivated by increasing the number of viewable favourites.

Radio data system (RDS)

RDS is a service of FM stations that considerably improves the finding of the desired station and its fault-free reception.

Advantages of RDS

- On the display, the programme name of the station appears instead of its frequency.
- During a station search the Infotainment system tunes in to RDS stations only.
- The Infotainment system always tunes into the best receivable broadcasting frequency of the set station by means of AF (alternative frequency).
- Depending on the station that is received, the Infotainment system displays radio text that can contain e.g. information on the current programme.

RDS settings

To configure the RDS settings options, activate the radio function and then select the FM waveband. Press **MENU** to display the FM waveband menu.

RDS

Set **RDS** to **On** or **Off**.

Note

If **RDS** is set to **Off**, RDS functions are not available.

Traffic Programme

Radio traffic service stations are RDS stations that broadcast traffic news. If the traffic service is switched on, the currently active function is interrupted for the duration of the traffic announcement.

Activate or deactivate **Traffic Program (TP)**.

If the radio traffic service is activated, **[TP]** is shown in the top line of all main menus. If the current station or media played is not a radio traffic service station, **[]** is displayed and a search is started automatically for the next radio traffic service station. As soon as a radio traffic service station is found, **[TP]** is highlighted. If no radio traffic service station is found, **[]** remains on the screen.

If a traffic announcement is broadcast on the respective radio traffic service station, a message is displayed.

To interrupt the announcement and return to the function previously activated, dismiss the alert.

Region

Sometimes RDS stations broadcast regionally different programmes on different frequencies.

Set **Region** to **On** or **Off**.

If regionalisation is switched on, alternative frequencies with the same regional programmes are selected where necessary.

If regionalisation is switched off, alternative frequencies of the stations are selected without regard to regional programmes.

Digital audio broadcasting

DAB broadcasts radio stations digitally.

Advantages of DAB

- DAB stations are indicated by the programme name instead of the broadcasting frequency.
- With DAB, several radio programmes (services) can be broadcast on a single frequency (ensemble).
- Besides high-quality digital audio services, DAB is also able to transmit programme-associated data and a multitude of other data services including travel and traffic information.
- As long as a given DAB receiver can pick up the signal sent out by a broadcasting station (even if the signal is very weak), sound reproduction is ensured.
- In the event of poor reception, the volume is reduced automatically to avoid the output of disagreeable noises.

If the DAB signal is too weak to be picked up by the receiver, reception is interrupted completely. This can be avoided by activating **DAB to DAB**

Linking and/or DAB to FM Linking in the DAB option menu (see below).

- Interference caused by stations that are on nearby frequencies (a phenomenon that is typical of AM and FM reception) does not occur with DAB.
- If the DAB signal is reflected by natural obstacles or buildings, the reception quality of DAB is improved, whereas AM or FM reception is considerably impaired in such cases.
- When DAB reception is enabled, the FM tuner of the Infotainment system remains active in the background and continually searches for the best receivable FM stations. If TP ↻ 143 is activated, traffic announcements of the FM station with the best reception are issued. Deactivate TP if DAB reception should not be interrupted by FM traffic announcements.

DAB settings

To configure the DAB settings options, activate the radio function and then select the DAB waveband. Press **MENU** to display the DAB waveband menu.

DAB Announcements

Besides their music programmes, a lot of DAB stations also broadcast announcements of various categories. If you activate some or all categories, the currently received DAB service is interrupted when an announcement of these categories is made.

Select **DAB Announcements** to display the DAB categories list.

Select the desired categories. The selected categories are marked with ✓.

Note

DAB announcements can only be received if the DAB waveband is activated.

DAB to DAB Linking

If this function is activated, the device switches over to the same service (programme) on another DAB ensemble (if available) when the DAB signal is too weak to be picked up by the receiver.

Set **DAB to DAB Linking** to **On** or **Off**.

DAB to FM Linking

If this function is activated, the device switches over to a corresponding FM station of the active DAB service (if available) when the DAB signal is too weak to be picked up by the receiver.

Set **DAB to FM Linking** to **On** or **Off**.

L Band

If **L Band** is activated, the Infotainment system receives an additional frequency range (1452 - 1492 MHz).

Set **L-Band** to **On** or **Off**.

Intellitext

The **Intellitext** function allows for the reception of additional information such as announcements, financial information, sports, news etc.

Select one of the categories and choose a specific item from the list to display detailed information.

External devices

General information	147
Playing audio	148

General information

A USB port for the connection of external devices is located in the centre console behind the parking brake or underneath the armrest.

Two USB ports for charging devices only are located at the rear of the centre console.

Note

The USB port must always be kept clean and dry.

USB port

An MP3 player, USB drive or smartphone can be connected to the USB port.

When connected to the USB port, the devices mentioned above can be operated via the controls and menus of the Infotainment system.

Note

Not all auxiliary devices are supported by the Infotainment system.

The Infotainment system can play music files contained in USB storage devices.

Connecting/disconnecting a device

Connect the USB device to the USB port.

Note

If a non-readable USB device is connected, a corresponding error message appears and the Infotainment system automatically switches to the previous function.

To disconnect the USB device, select another function and then remove the USB storage device.

Caution

Avoid disconnecting the device during playback. This may damage the device or the Infotainment system.

MTP device settings

For devices connected via MTP, additional settings can be adjusted in the settings menu.

In an active audio source, press **MENU**, scroll through the list and select **Settings**. Select **Phone Connection (MTP Only)**.

If you want the device to be only charged on the USB port, activate **Charge Only**. If you switch to the USB audio source while this setting is activated, you are prompted with a charging message.

If you wish to play music files stored on the device, activate **Scan Music Folder Only** or **Scan All Folder**.

Bluetooth

Bluetooth enabled audio sources (e.g. music mobile phones, MP3 players featuring Bluetooth, etc.), which support the Bluetooth music profiles A2DP and AVRCP can be connected wirelessly to the Infotainment system.

The Infotainment system can play music files contained in Bluetooth devices.

Connecting/disconnecting a device

For a detailed description of the Bluetooth connection ⇨ 152.

Bluetooth device list

To access the Bluetooth device list, activate the Bluetooth audio source, press **MENU** and then select **Manage Bluetooth Devices**.

For a detailed description of the Bluetooth device list ⇨ 152.

File formats

Only devices formatted in the FAT32, NTFS and HFS+ file systems are supported.

Note

Some files may not be played properly. This may be due to a different recording format or the condition of the file.

Files from online shops to which Digital Rights Management (DRM) has been applied cannot be played.

The playable audio file formats are MP3, WMA, AAC and AIF.

When playing a file with ID3 tag information, the Infotainment system can display information, e.g. on the track title and artist.

Playing audio

Starting playback

Connect the device ⇨ 147.

Repeatedly press **MEDIA** to activate the desired media source.

Example: USB source.



Function buttons

Skipping to previous or next file

Press **◀◀** or **▶▶** to play the previous or next track.

If **◀◀** is pressed within the first five seconds of the song playing, the system skips to the beginning of the current track.

Fast forwarding or rewinding

Press and hold **◀◀** or **▶▶** to rewind or fast forward.

Playback order

Press **MENU** in the respective audio source and scroll through the list to **Shuffle Songs**.

To play the songs on the device in random order, set **Shuffle Songs** to **On**.

To play the songs in normal order, set **Shuffle Songs** to **Off**.

Browsing for a song

Depending on the device, you may browse for songs in categories and subcategories or a folder structure.

Note

For this function to be available, the indexing process must be completed.

Categories

To browse for a song, press **MENU** in the respective audio source and then select **Browse**.

Navigate through the browse structure and select the desired track.

Folders

To browse the song, press **MENU** and then select **Folder View**. The folder structure on the respective device is displayed.

Navigate through the folder structure and select the desired track.

Speech recognition

General information 150
Usage 150

General information

The voice pass-thru application of the Infotainment system allows access to the speech recognition commands on your smartphone. See your smartphone manufacturer's operating instructions to find out whether your smartphone supports this feature.

In order to use the voice pass-thru application, the smartphone must be connected to the Infotainment system via USB cable ↪ 147 or via Bluetooth ↪ 152.

Usage

Activating speech recognition

Press and hold **PHONE** on the control panel or  on the steering wheel to start a speech recognition session. A voice command message is displayed on the screen.

As soon as a beep is heard, you can say a command. For information on the commands supported, see the operating instructions for your smartphone.

Adjusting the volume of voice prompts

Turn  on the control panel or press **+ / -** on the right side of the steering wheel to increase or decrease the volume of voice prompts.

Deactivating speech recognition

Press  on the steering wheel. The voice command message disappears, the speech recognition session is ended.

Phone

General information	151
Bluetooth connection	152
Emergency call	153
Operation	154
Text messages	155
Mobile phones and CB radio equipment	156

General information

The Phone portal provides you with the possibility of having mobile phone conversations via a vehicle microphone and the vehicle loudspeakers as well as operating the most important mobile phone functions via the Infotainment system in the vehicle. To be able to use the Phone portal, the mobile phone must be connected to the Infotainment system via Bluetooth.

Not all Phone functions are supported by every mobile phone. The usable phone functions depend on the relevant mobile phone and network provider. You will find further information on this in the operating instructions for your mobile phone, or you can enquire about them with your network provider.

Important information for operation and traffic safety

Warning

Mobile phones have effects on your environment. For this reason, safety regulations and directions have been prepared. You should be familiar with the related directions before you use the telephone function.

Warning

Use of the hands-free facility while driving can be dangerous because your concentration is reduced when telephoning. Park your vehicle before you use the hands-free facility. Follow the stipulations of the country in which you find yourself at present.

Do not forget to follow the special regulations that apply in specific areas and always switch off the mobile phone if the use of mobile phones is prohibited, if

interference is caused by the mobile phone or if dangerous situations can occur.

Bluetooth

The Phone portal is certified by the Bluetooth Special Interest Group (SIG).

You will find further information about the specification on the internet at <http://www.bluetooth.com>.

Bluetooth connection

Bluetooth is a radio standard for the wireless connection of e.g. mobile phones or other devices.

To be able to set up a Bluetooth connection to the Infotainment system, the Bluetooth function of the Bluetooth device must be activated. For further information, please consult the operating instructions for the Bluetooth device.

Via the Phone portal, pairing (PIN code exchange between Bluetooth device and Infotainment system) and

connecting of the Bluetooth devices with the Infotainment system are carried out.

Pairing a device

Important information

- Up to five devices can be paired to the system.
- Only one paired device can be connected to the Infotainment system at a time.
- Pairing only needs to be carried out once, unless the device is deleted from the list of paired devices. If the device has been connected previously, the Infotainment system establishes the connection automatically.
- Bluetooth operation considerably drains the device's battery. Therefore, connect the device to the USB port for charging.

Pairing the first device

1. Press **PHONE** and then select **Pair**.

A message is displayed on the Infotainment system indicating

the name and PIN code of the Infotainment system.

2. Start Bluetooth searching on the Bluetooth device to be paired.
3. Confirm pairing:
 - If SSP (secure simple pairing) is supported: Compare the PIN code (if demanded) and confirm the messages on the Infotainment system and the Bluetooth device.
 - If SSP (secure simple pairing) is not supported: Enter the Infotainment PIN code on the Bluetooth device and confirm your input.
4. The Infotainment system and the device are paired. The phone menu is displayed.
5. If available on the Bluetooth device, phone book and calls lists are downloaded to the Infotainment system. If required, confirm the respective message on your smartphone.

Note

For the contacts to be read by the Infotainment system, they must be stored in the phone memory of the mobile phone.

Pairing another device

Press **PHONE**, scroll through the list and select **Bluetooth Devices**.

Press **Add** to start the pairing process of another device.

Proceed from step 2 of "Pairing the first device" (see above).

Connecting a paired device

Press **PHONE**, scroll through the list and select **Bluetooth Devices**.

Mark the desired device and select **Connect**.

If necessary, the device currently connected is disconnected. The selected device is connected.

Disconnecting a device

Press **PHONE**, scroll through the list and select **Bluetooth Devices**.

Mark the device currently connected and select **Disconnect**.

The device is disconnected.

Deleting a device

Press **PHONE**, scroll through the list and select **Bluetooth Devices**.

Mark the device you wish to delete from the device list and select **Delete**.

The device is deleted.

Emergency call**⚠ Warning**

Connection setup cannot be guaranteed in all situations. For this reason you should not rely exclusively on a mobile phone when a vitally important communication (e.g. a medical emergency) is concerned.

In some networks it may be necessary for a valid SIM card to be properly inserted in the mobile phone.

⚠ Warning

Bear in mind that you can make and receive calls with the mobile phone if it is in a service area with a sufficiently strong signal. Under certain circumstances, emergency calls cannot be made on all mobile phone networks; it is possible that they cannot be made when certain network services and/or telephone functions are active. You can enquire about this with the local network operators.

The emergency call number can differ depending on the region and country. Please enquire beforehand about the correct emergency call number for the relevant region.

Making an emergency call

Dial the emergency call number (e.g. **112**).

The telephone connection to the emergency call centre is set up.

Answer when the service personnel questions you about the emergency.

Warning

Do not end the call until you are requested to do so by the emergency call centre.

Operation

As soon as a connection via Bluetooth has been set up between your mobile phone and the Infotainment system, you can operate many functions of your mobile phone via the Infotainment system.

Note

Not every mobile phone supports all functions of the Phone portal. Therefore, deviations from the range of functions described below are possible.

Initiating a phone call**Keypad**

Press **PHONE** to display the phone menu.



Scroll through the list and select **Keypad**. The keypad is displayed.



Turn **MENU** to highlight the digit you wish to enter and then press **MENU** to select the respective digit. Enter the desired number.

Select **☒** or press **BACK** to delete digits.

Select **Call** to initiate the phone call.

Contacts

Press **PHONE** to display the phone menu.

Select **Contacts**. The contacts list is displayed.

Scroll through the list and select the desired contacts entry. The contact is displayed.

Select one of the phone numbers stored under that contact. The number is dialled.

Calls lists

Press **PHONE** to display the phone menu.

Select **Recent Calls**. The recent calls list is displayed.

Depending on which call you are searching for, select **Missed**, **Received** or **Sent**.

Select one of the phone numbers stored in the recent calls list. The number is dialled.

Incoming phone call**Taking a phone call**

If a radio or media source is active when a call comes in, the audio source is muted and remains muted until the call is ended.

A message with the caller's name or number is displayed.



To answer the call, select **Answer**.

Rejecting a phone call

To reject the call, select **Ignore** in the message.

Functions during a phone call

During a phone call, the in-call view is displayed.

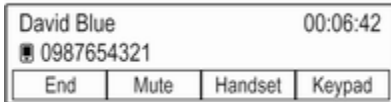

Ending a phone call

Select **End** to end the call.

Deactivating the microphone

Select **Mute** to temporarily deactivate the microphone.

The screen button changes to **Unmute**.

To reactivate the microphone, select **Unmute**.

Deactivating the hands-free function

To continue the conversation on your mobile phone, select **Handset**.

The screen button changes to **Hands-free**.

To reactivate the hands-free function, select **Hands-free**.

Second incoming phone call

If a second phone call comes in, another message with the caller's name or number is displayed.

To answer the second call and place the first call on hold, select **Switch**.

To reject the call, select **Ignore** in the message.

Switching between the phone calls

Press **PHONE** or  on the steering wheel audio control to toggle between the two calls.

Information on the call currently active is shown on the display.

Ending the phone calls

The calls can be ended one at a time.

Select **End**. The call currently active is ended.

Text messages

Text messages which are received while a phone is connected to the Infotainment system can be displayed on the Info-Display.

Prerequisites

The following prerequisites must be met:

- The Bluetooth function of the respective phone must be activated (see the operating instructions for your device).
- Dependent on the phone, it may be required to set the device to "visible" (see the operating instructions for your device).

- The respective phone must be paired and connected to the Infotainment system. For a detailed description ⇨ 152.
- The respective phone must support Bluetooth Message Access Profile (BT MAP).

Viewing a message

Note

If the vehicle is going faster than 8 km/h, the text message is not displayed on the screen.

When a new text message is received, a message is displayed.



Select **View** to read the message.

Mobile phones and CB radio equipment

Installation instructions and operating guidelines

The vehicle specific installation instructions and the operating guidelines of the mobile phone and hands-free manufacturer must be observed when installing and operating a mobile telephone. Failure to do so could invalidate the vehicle type approval (EU directive 95/54/EC).

Recommendations for fault-free operation:

- The exterior antenna must be professionally installed to obtain the maximum range possible.
- Maximum transmission power: 10 watts.
- The mobile phone must be installed in a suitable spot. Consider relevant note in the Owner's Manual, chapter **Airbag system**.

Seek advice on predetermined installation points for the external antenna or equipment holder and ways of using devices with a transmission power exceeding 10 watts.

Use of a hands-free attachment without external antenna with mobile telephone standards GSM 900/1800/1900 and UMTS is only permitted if the maximum transmission power of the mobile telephone is 2 watts for GSM 900 or 1 watt for the other types.

For reasons of safety, do not use the phone while driving. Even use of a hands-free set can be a distraction while driving.

Warning

Operation of radio equipment and mobile telephones which fail to meet above mentioned mobile telephone standards is only permitted using an antenna located outside of the vehicle.

Caution

Mobile telephones and radio equipment may lead to malfunctions in the vehicle electronics when operated inside the vehicle with no exterior antenna, unless the above mentioned regulations are observed.

Index

- A**
- Activating Bluetooth music..... 148
 - Activating radio..... 142
 - Activating the Infotainment system..... 136
 - Activating the phone portal..... 154
 - Activating USB..... 148
 - Audio files..... 147
 - Auto Set..... 139
 - Auto volume control..... 139
- B**
- BACK button..... 138
 - Basic operation..... 138
 - Control panel..... 138
 - Bluetooth connection..... 152
 - Bluetooth music..... 147
- C**
- Category list..... 142
 - Control elements
 - Infotainment system..... 134
 - Steering wheel..... 134
 - Control elements overview..... 134
- D**
- DAB..... 144
 - DAB linking..... 144
 - Digital audio broadcasting..... 144
- E**
- Emergency call..... 153
- F**
- Favourite lists..... 143
 - Retrieving stations..... 143
 - Storing stations..... 143
 - File formats
 - Audio files..... 147
 - Frequency list..... 142
- G**
- General information.... 147, 150, 151
 - Bluetooth music..... 147
 - Infotainment system..... 132
 - Phone..... 151
 - Radio..... 142
 - USB..... 147
- I**
- Infotainment control panel..... 134
 - Intellitext..... 144
- L**
- Language..... 139
 - L-Band..... 144
- M**
- Maximum startup volume..... 139
 - MENU knob..... 138
 - Menu operation..... 138

Mobile phones and CB radio equipment	156
Mute.....	136

O

Operation.....	154
Bluetooth music.....	148
Infotainment system.....	136
Menu.....	138
Phone.....	154
Radio.....	142
USB.....	148

P

Pairing.....	152
Phone	
Bluetooth.....	151
Bluetooth connection.....	152
Emergency calls.....	153
General information.....	151
Hands-free mode.....	154
Phone book.....	154
Recent calls.....	154
Ringtone.....	154
Text messages.....	155
Phone book.....	154
Phone call	
Initiating.....	154
Rejecting.....	154
Taking.....	154
Playing audio.....	148

R

Radio	
Category list.....	142
DAB.....	144
DAB announcements.....	144
DAB menu.....	144
Digital audio broadcasting.....	144
Favourite lists.....	143
FM menu.....	143
Frequency list.....	142
Intellitext.....	144
L-Band.....	144
Radio data system.....	143
RDS.....	143
Region.....	143
Regionalisation.....	143
Retrieving stations.....	143
Station list.....	142
Station search.....	142
Storing stations.....	143
TP.....	143
Traffic programme.....	143
Waveband.....	142
Radio data system (RDS)	143
Region.....	143
Regionalisation.....	143
Restore factory settings.....	139
Retrieving stations.....	143
Ringtone.....	154

S

Speech recognition.....	150
Station list.....	142
Station search.....	142
Storing stations.....	143
Switching the Infotainment system on.....	136
System settings.....	139
Language.....	139
Restore factory settings.....	139
Time and date.....	139
Valet mode.....	139

T

Text messages.....	155
Theft-deterrent feature	133
Time.....	139
Tone settings.....	138
TP.....	143
Traffic programme.....	143

U

Usage.....	136, 142, 150
Bluetooth music.....	148
Infotainment system.....	136
Menu.....	138
Phone.....	154
USB.....	148
USB.....	147

V

Valet mode

Locking..... 139

Unlocking..... 139

Voice recognition..... 150

Volume

Auto volume control..... 139

Maximum startup volume..... 139

Mute function..... 136

Setting the volume..... 136

Speed compensated volume. . 139

Volume limitation at high
temperatures..... 136

Volume settings..... 139

W

Waveband selection..... 142

Phone holder

Phone holder	162
Index	166

Phone holder

Phone holder 162

Phone holder

General information



The phone holder is attached to a power connector (PowerFlex Bar). Further information regarding power connector is available in the Owner's Manual.

Smartphones with following dimensions can be attached to the phone holder:

- height: up to 158.5 mm
- width: 57 to 78 mm
- depth: 6 to 11 mm

⚠ Warning

Devices attached to the phone holder must be used in a way that driver distraction is avoided and the vehicle can be driven safely at all times. You must always comply with the respective laws and regulations of the country where you are driving. These laws may differ from the information in this manual. If in doubt, stop your vehicle and operate devices while the vehicle is stationary.

Caution

To avoid theft, do not leave the mobile phone in the phone holder when leaving the vehicle.

Usage

Adapting the phone holder to the size of the smartphone

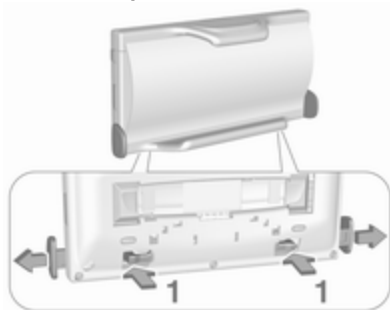

1. Press both brackets (1) on the rear side to disengage the shifters for width adjustment and pull them out.

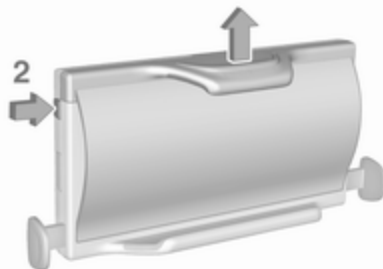

2. Press button (2) on left upper side to disengage shifter for height adjustment.
3. Insert the smartphone.

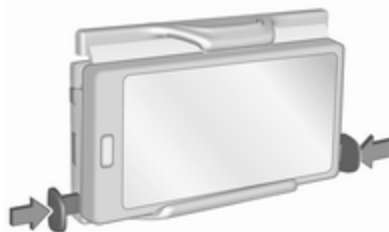

4. Adjust the width of the phone holder to the width of the phone by pushing the shifters together.

Attaching the phone holder to the power connector

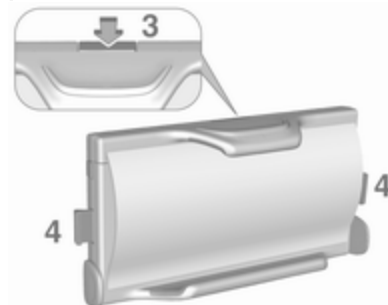

1. Press release button (3) to disengage locking shifters (4).



2. Attach the phone holder to the power connector and press both locking shifters (4) to lock.

Inserting the phone in the phone holder

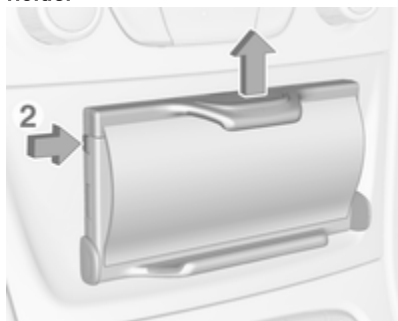

1. Press button (2) to disengage shifter.
2. Insert the smartphone in a way that the power supply of the smartphone is accessible and no buttons are pressed.

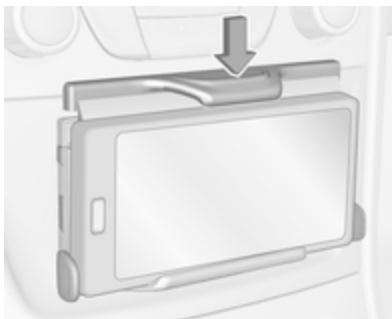

3. Press down the shifter.

Connecting the smartphone with the power supply

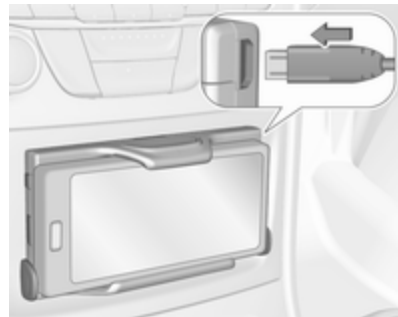

Connect the smartphone to the phone holder by using the compatible connecting cable. Different versions of the connecting cable are available as accessory.

Operating the smartphone

When the smartphone is connected with the power supply, it will be charged with ignition on.

For connecting the smartphone with the Infotainment system, a Bluetooth® connection must be established.

Removing the phone from the phone holder

1. Disconnect the power supply from the phone.

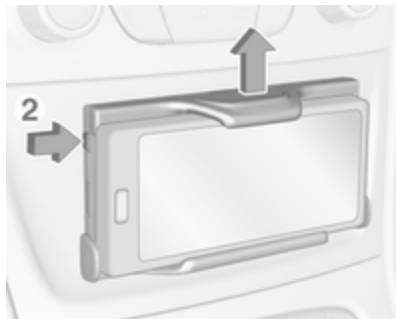

2. Press button (2) on left upper side to disengage shifter for height adjustment.
3. Remove the smartphone from the phone holder.

Removing the phone holder from the power connector

1. Press down the shifter for height adjustment.

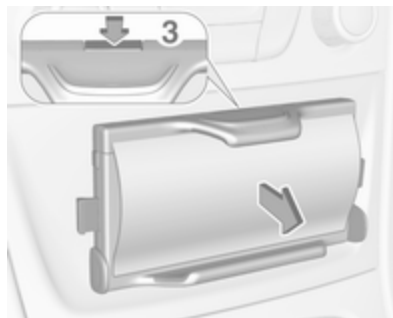

2. Press the release button (3) and remove the phone holder.

Index

P

Phone holder..... 162

www.opel.com

Copyright by ADAM OPEL AG, Rüsselsheim, Germany.

The information contained in this publication is effective as of the date indicated below. Adam Opel AG reserves the right to make changes to the technical specifications, features and design of the vehicles relative to the information in this publication as well as changes to the publication itself.

Edition: January 2017, ADAM OPEL AG, Rüsselsheim.

Printed on chlorine-free bleached paper.

ID-OASKIBSE1701-en

