

KARL

Owner's Manual



Contents

Introduction	2
In brief	6
Keys, doors and windows	21
Seats, restraints	35
Storage	53
Instruments and controls	60
Lighting	93
Climate control	99
Driving and operating	108
Vehicle care	137
Service and maintenance	175
Technical data	179
Customer information	189
Index	196

Introduction

Fuel	Designation	<input type="text"/>		
Engine oil	Grade	<input type="text"/>		
	Viscosity	<input type="text"/>		
Tyre pressure	Tyre size		Front	Rear
	Summer tyres	<input type="text"/>	<input type="text"/>	<input type="text"/>
	Winter tyres	<input type="text"/>	<input type="text"/>	<input type="text"/>
Weights	Gross vehicle weight rating	<input type="text"/>		
	- Kerb weight, basic model	<input type="text"/>		
	= Loading	<input type="text"/>		

Vehicle specific data

Please enter your vehicle's data on the previous page to keep it easily accessible. This information is available in the sections "Service and maintenance" and "Technical data" as well as on the identification plate.

Introduction

Your vehicle is a designed combination of advanced technology, safety, environmental friendliness and economy.

This Owner's Manual provides you with all the necessary information to enable you to drive your vehicle safely and efficiently.

Make sure your passengers are aware of the possible risk of accident and injury which may result from improper use of the vehicle.

You must always comply with the specific laws and regulations of the country that you are in. These laws may differ from the information in this Owner's Manual.

Disregarding the description given in this manual may affect your warranty.

When this Owner's Manual refers to a workshop visit, we recommend your Opel Service Partner.

For gas vehicles we recommend an Opel Repairer authorised for servicing gas vehicles.

All Opel Service Partners provide first-class service at reasonable prices. Experienced mechanics trained by Opel work according to specific Opel instructions.

All Opel Dealers provide first-class service at reasonable prices. Experienced mechanics trained by Opel work according to specific Opel instructions.

The customer literature pack should always be kept ready to hand in the vehicle.

Using this manual

- This manual describes all options and features available for this model. **Certain descriptions, including those for display and menu functions, may not apply to your vehicle due to model**

variant, country specifications, special equipment or accessories.

- The "In brief" section will give you an initial overview.
- The table of contents at the beginning of this manual and within each section shows where the information is located.
- The index will enable you to search for specific information.
- This Owner's Manual depicts left-hand drive vehicles. Operation is similar for right-hand drive vehicles.
- The Owner's Manual uses the engine identifier code. The corresponding sales designation can be found in the section "Technical data".
- Directional data, e.g. left or right, or front or back, always relate to the direction of travel.
- Displays may not support your specific language.
- Display messages and interior labelling are written in **bold** letters.

Danger, Warnings and Cautions

Danger

Text marked **⚠ Danger** provides information on risk of fatal injury. Disregarding this information may endanger life.

Warning

Text marked **⚠ Warning** provides information on risk of accident or injury. Disregarding this information may lead to injury.

Caution

Text marked **Caution** provides information on possible damage to the vehicle. Disregarding this information may lead to vehicle damage.

Symbols

Page references are indicated with ⇨. ⇨ means "see page".

Page references and index entries refer to the indented headings given in the section table of content.

Chronological order to select menu entries in the vehicle personalisation is indicated with ➤.

We wish you many hours of pleasurable driving.

Adam Opel GmbH

In brief

Initial drive information

Vehicle unlocking



Press  to unlock the doors and load compartment.

Manual door locks

To unlock the front doors or the tailgate, turn the key in the lock anti-clockwise. To unlock a rear door, pull the interior lock button on the respective door.

Open the doors by pulling the handles.



To open the tailgate, push the switch on the underside of the brand emblem and lift up slightly.

Radio remote control ⇨ 22, Central locking system ⇨ 23.

Front doors ⇨ 25.

Load compartment ⇨ 26.

Seat adjustment

Longitudinal adjustment



Pull handle, slide seat, release handle. Try to move the seat back and forth to ensure that the seat is locked in place.

Seat position ⇨ 36, Seat adjustment ⇨ 37.

Backrest inclination



Pull lever, adjust inclination and release lever. Allow the seat to engage audibly.

Seat position ⇨ 36, Seat adjustment ⇨ 37.

Seat height

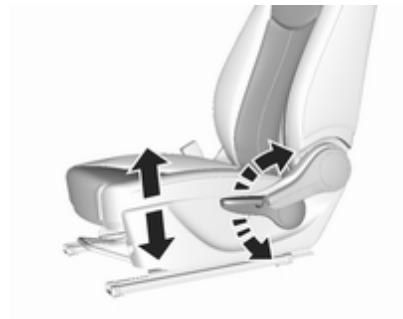

Lever pumping motion

up : seat higher
down : seat lower

Seat position ⇨ 36, Seat adjustment ⇨ 37.

Head restraint adjustment



Press release button, adjust height and engage.

Head restraints ⇨ 35.

Seat belt



Pull out the seat belt and fasten in belt buckle. The seat belt must not be twisted and must fit close against the body. The backrest must not be tilted back too far (maximum approx. 25 °). To unfasten belt, press red button on belt buckle.

Seat position ⇨ 36, Seat belts ⇨ 39, Airbag system ⇨ 41.

Mirror adjustment

Interior mirror



To adjust the mirror, move the mirror housing in the desired direction.

Manual anti-dazzle interior mirror ⇨ 30.

Exterior mirrors

Manual adjustment

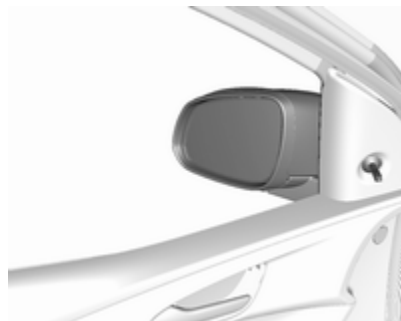

Swivel lever in required direction.
Exterior mirrors ⇨ 29, Manual adjustment ⇨ 29.

Electric adjustment



Select the relevant exterior mirror and adjust it.
Electric adjustment ⇨ 29, Folding exterior mirrors ⇨ 29.
Heated exterior mirrors ⇨ 29.

Steering wheel adjustment

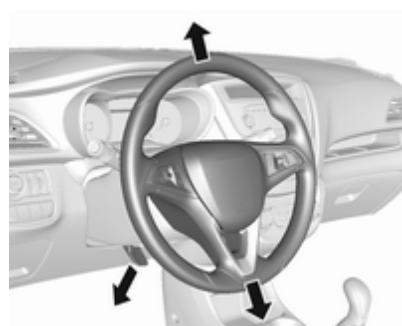

Unlock the lever, adjust the steering wheel, then engage the lever and ensure it is fully locked.

Do not adjust the steering wheel unless the vehicle is stationary and the steering wheel lock has been released.

Airbag system ⇨ 41, Ignition positions ⇨ 109.

Instrument panel overview

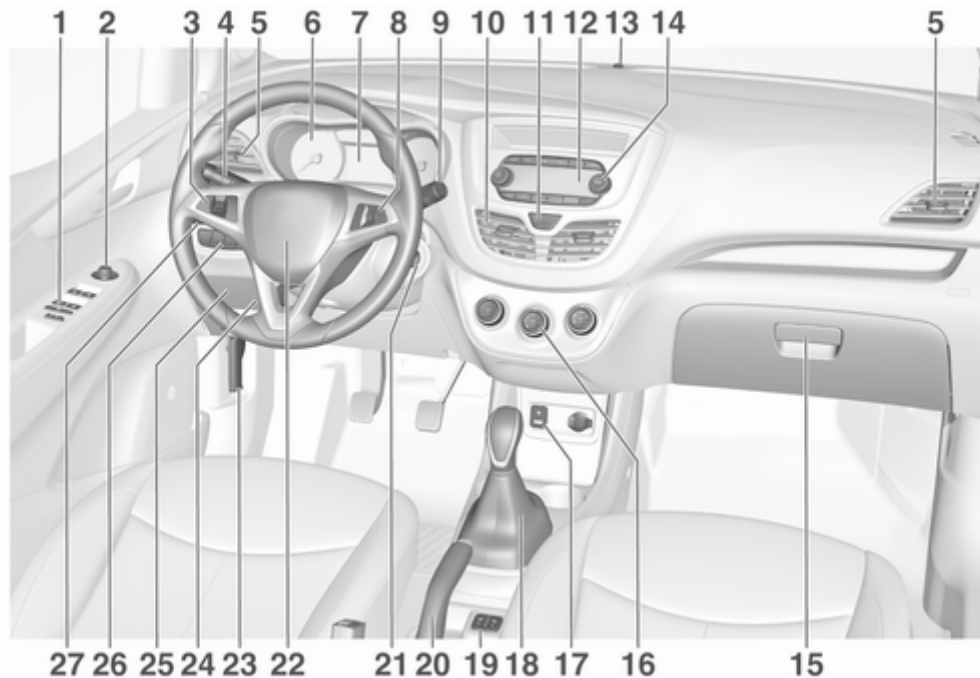

<p>1 Central locking system 23 Power windows 31</p> <p>2 Exterior mirrors 29</p> <p>3 Cruise control 124 Speed limiter 125 Heated steering wheel 61</p> <p>4 Turn and lane-change signals, headlight flash, low beam and high beam 95 Exit lighting 97 Parking lights 96</p> <p>5 Side air vents 105</p> <p>6 Instruments 65</p> <p>7 Driver Information Centre 77</p> <p>8 Steering wheel controls 61</p> <p>9 Windscreen wiper, windscreen washer system, rear window wiper, rear window washer system 62</p> <p>10 Centre air vents 105</p> <p>11 Hazard warning flashers 94</p> <p>12 Info-Display 82</p>	<p>13 Anti-theft alarm system status LED 27</p> <p>14 Infotainment system</p> <p>15 Glovebox 53</p> <p>16 Climate control system 99</p> <p>17 AUX input, USB input</p> <p>18 Selector lever, manual transmission 115 Selector lever, manual transmission automated 116</p> <p>19 Seat heating 38</p> <p>20 Parking brake 120</p> <p>21 Ignition switch with steering wheel lock 109</p> <p>22 Horn 62 Driver airbag 44</p> <p>23 Bonnet release lever 139</p> <p>24 Steering wheel adjustment . . 61</p> <p>25 Fuse box 153</p> <p>26 Traction Control system 121 City mode 123 Stop-start system 111 Fuel selector 67 Lane departure warning 128</p>	<p>Electronic Stability Control . 122</p> <p>27 Light switch 93 Headlight range adjustment 94 Front fog light 95 Rear fog light 95 Brightness of instrument panel illumination 96</p>
--	---	--

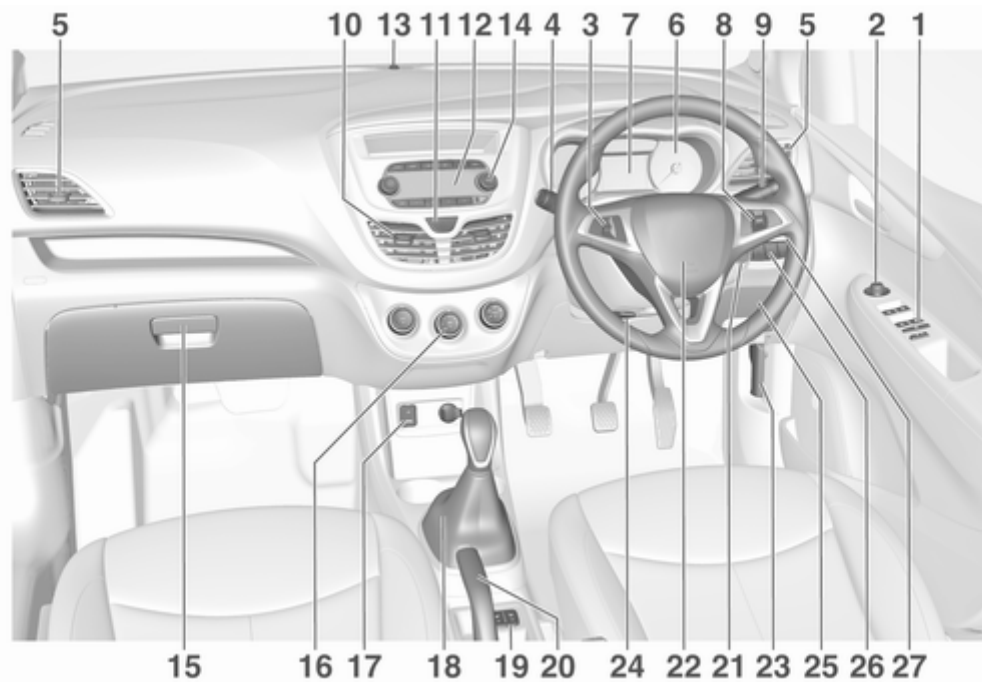

1	Central locking system	23	13	Anti-theft alarm system status LED	27		Electronic Stability Control .	122
	Power windows	31	14	Infotainment system		27	Light switch	93
2	Exterior mirrors	29	15	Glovebox	53		Headlight range adjustment	94
3	Cruise control	124	16	Climate control system	99		Front fog light	95
	Speed limiter	125	17	AUX input, USB input			Rear fog light	95
	Heated steering wheel	61	18	Selector lever, manual transmission	115		Brightness of instrument panel illumination	96
4	Turn and lane-change signals, headlight flash, low beam and high beam	95		Selector lever, manual transmission automated	116			
	Exit lighting	97	19	Seat heating	38			
	Parking lights	96	20	Parking brake	120			
5	Side air vents	105	21	Ignition switch with steering wheel lock	109			
6	Instruments	65	22	Horn	62			
7	Driver Information Centre	77		Driver airbag	44			
8	Steering wheel controls	61	23	Bonnet release lever	139			
9	Windscreen wiper, windscreen washer system, rear window wiper, rear window washer system	62	24	Steering wheel adjustment . .	61			
10	Centre air vents	105	25	Fuse box	153			
11	Hazard warning flashers	94	26	Traction Control system	121			
12	Info-Display	82		City mode	123			
				Stop-start system	111			
				Fuel selector	67			
				Lane departure warning	128			

Exterior lighting

Light switch



Turn light switch:

- : lights off
- ☞☜ : sidelights
- ☞☜☞☜ : headlights

Fog lights

Press button in light switch:

- ☞☜☞☜ : front fog lights
- ☞☜☞☜☞☜ : rear fog light

Headlight flash, high beam and low beam



- headlight flash : pull lever
- high beam : push lever
- low beam : push or pull lever

High beam ⇨ 93, Headlight flash
⇨ 93.

Turn and lane-change signals



- lever up : right turn signal
- lever down : left turn signal

Turn and lane-change signals
⇨ 95, Parking lights ⇨ 96.

Hazard warning flashers



Operated by pressing .
Hazard warning flashers ⇨ 94.

Horn

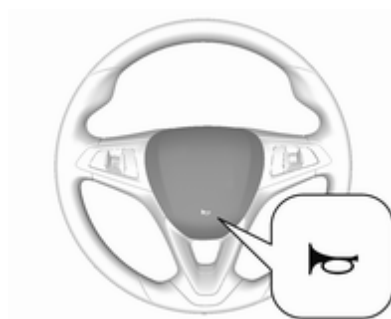



Press .

Washer and wiper systems

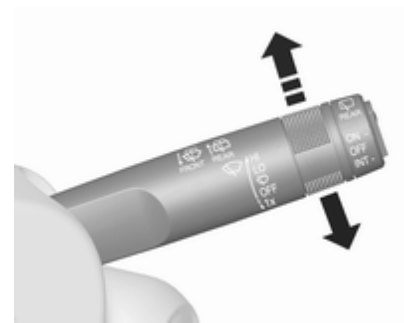
Windscreen wiper



HI : fast
LO : slow
 : interval wiping
OFF : off

For single wipe when the wiper is off, press lever down to position .

Windscreen wiper ⇨ 62.

Windscreen washer

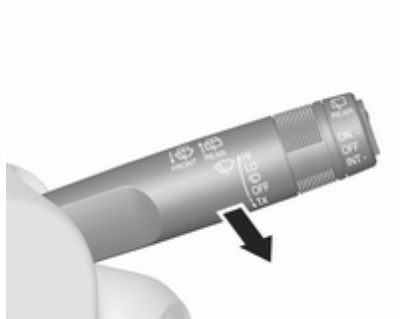

Pull lever.

Windscreen washer system ⇨ 62,
Washer fluid ⇨ 141, Wiper blade
replacement ⇨ 144.

Rear window wiper



Press the rocker switch to activate the
rear window wiper:

upper switch	: continuous operation
lower switch	: intermittent operation
middle position	: off

Rear window washer

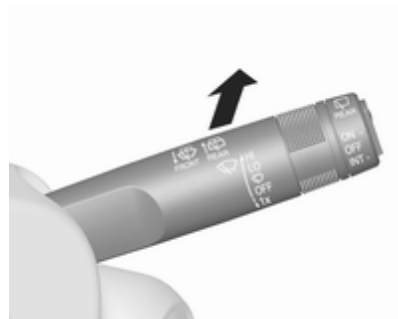

Push lever.

Washer fluid is sprayed on the rear
window and the wiper wipes a few
times.

Rear window wiper/washer ⇨ 63.

Climate control

Heated rear window



The heating is operated by pressing .



Heated rear window ⇨ 32.

Heated exterior mirrors

Pressing  also activates the heated exterior mirrors.

Heated exterior mirrors ⇨ 29.

Demisting and defrosting the windows

- Set air distribution control to .
- Set temperature control to warmest level.
- Set fan speed to highest level.
- Electronic climate control system: Press .
- Switch on heated rear window .
- Open side air vents as required and direct them towards the door windows.

Climate control system ⇨ 99.

Transmission

Manual transmission

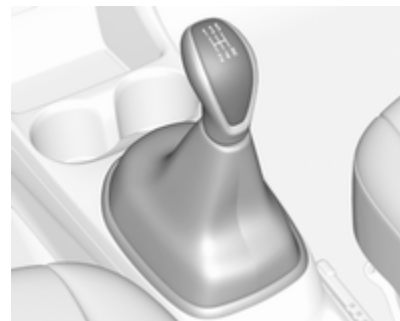

To engage reverse, depress the clutch pedal and engage the reverse gear.

If the gear does not engage, set the lever to neutral, release the clutch pedal and depress again; then repeat gear selection.

Manual transmission ⇨ 115.

Manual transmission automated

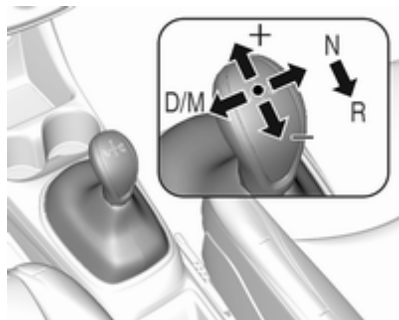

R : reverse, engage only when vehicle is stationary

N : neutral

D : automatic mode

M : manual mode

+ : upshift in manual mode

- : downshift in manual mode

Manual transmission automated

⇨ 116.

Starting off

Check before starting off

- Tyre pressure and condition
⇨ 156,
⇨ 188.
- Engine oil level and fluid levels
⇨ 140.
- All windows, mirrors, exterior lighting and number plates are free from dirt, snow and ice and are operational.
- Proper position of mirrors, seats, and seat belts ⇨ 29, ⇨ 36, ⇨ 40.
- Brake function at low speed, particularly if the brakes are wet.

Starting the engine

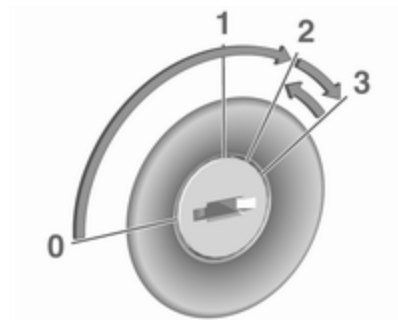

- Turn key to position **1**.
- Move the steering wheel slightly to release the steering wheel lock.
- Manual transmission: operate clutch and brake pedal.
Manual transmission automated: operate brake pedal.
Automatic transmission: operate brake pedal and move selector lever to **P** or **N**.
- Do not operate accelerator pedal.
- Turn key to position **3** and release.

Starting the engine ⇨ 110.

Stop-start system



If the vehicle is at a low speed or at a standstill and certain conditions are fulfilled, activate an Autostop as follows:

Vehicles with manual transmission:

- Depress the clutch pedal.
- Engage neutral gear.
- Release the clutch pedal.

An Autostop is indicated by the needle at the AUTOSTOP position in the tachometer.

To restart the engine, depress the clutch pedal again.

Vehicles with manual transmission automated:

If the vehicle is at a standstill with the brake pedal depressed, Autostop is activated automatically, indicated by the needle at the AUTOSTOP position in the tachometer.

Release the brake pedal or move selector lever out of **D** to restart the engine.

Stop-start system ⇨ 111.

Parking

Warning

- Do not park the vehicle on an easily ignitable surface. The high temperature of the exhaust system could ignite the surface.
- Always apply the parking brake. Activate the manual parking brake without pressing the release button. Apply as firmly as possible on a downhill slope or uphill slope. Depress brake pedal at the same time to reduce operating force.
- Switch off the engine.
- If the vehicle is on a level surface or uphill slope, engage first gear before removing the ignition key. On an uphill slope, turn the front wheels away from the kerb.

If the vehicle is on a downhill slope, engage reverse gear before removing the ignition

key. Turn the front wheels towards the kerb.

- Close the windows and the sunroof.
- Remove the ignition key from the ignition switch. Turn the steering wheel until the steering wheel lock is felt to engage.

For vehicles with manual transmission automated, the key can only be removed from the ignition switch when the parking brake is applied.

- Lock the vehicle by pressing  on the radio remote control. Activate the anti-theft alarm system ⇨ 27.
- The engine cooling fans may run after the engine has been switched off ⇨ 139.

Caution

After running at high engine speeds or with high engine loads, operate the engine briefly at a low load or run in neutral for approx. 30 seconds before switching off, in order to protect the turbocharger.

Keys, locks ⇨ 21, Laying-up the vehicle for a long period of time ⇨ 138.

Keys, doors and windows

Keys, locks	21
Keys	21
Radio remote control	22
Memorised settings	23
Central locking system	23
Child locks	25
Doors	25
Front doors	25
Rear doors	26
Load compartment	26
Vehicle security	27
Anti-theft alarm system	27
Immobiliser	28
Exterior mirrors	29
Mirrors	29
Manual adjustment	29
Electric adjustment	29
Folding mirrors	29
Heated mirrors	29
Interior mirrors	30
Manual anti-dazzle	30
Windows	30
Windscreen	30

Manual windows	31
Power windows	31
Heated rear window	32
Sun visors	33
Roof	33
Sunroof	33

Keys, locks

Keys

Caution
Do not attach heavy or bulky items to the ignition key.

Replacement keys

The key number is specified on a detachable tag.

The key number must be quoted when ordering replacement keys, as it is a component of the immobiliser system.

Locks ⇨ 172.

The code number of the adapter for the locking wheel bolts is specified on a card. It must be quoted when ordering a replacement adapter.

Wheel changing ⇨ 165.

Key with foldaway key section



Press button to extend. To fold the key, first press the button.

Radio remote control



Used to operate:

- central locking system
- anti-theft alarm system

The radio remote control has a range of approx. 20 metres. It can be restricted by external influences. The hazard warning flashers confirm operation.

Handle with care, protect from moisture and high temperatures and avoid unnecessary operation.

Fault

If the central locking system cannot be operated with the radio remote control, it may be due to the following:

- The range is exceeded.
- The battery voltage is too low.
- Frequent, repeated operation of the radio remote control while not in range, which will require re-synchronisation.
- Overload of the central locking system by operating at frequent intervals, the power supply is interrupted for a short time.
- Interference from higher-power radio waves from other sources.

Unlocking ⇨ 23.

Radio remote control battery replacement

Replace the battery as soon as the range reduces.



Batteries do not belong in household waste. They must be disposed of at an appropriate recycling collection point.

Key with foldaway key section



Extend the key and open the unit sideways. Replace the battery (battery type CR 2032), paying attention to the installation position. Close the unit and synchronise.

Memorised settings

Whenever the key is removed from the ignition switch, the following settings are automatically memorised by the key:

- lighting
- presets for Infotainment system
- central locking system
- comfort settings

The saved settings are automatically used the next time the memorised key is inserted into the ignition switch and turned to position 1 ↻ 109.

A precondition is that **Personalization By Driver** is activated in the personal settings of the Info-Display.

This must be set for each key used.
Vehicle personalisation ↻ 86.

Central locking system

Unlocks and locks doors and load compartment.

Note



In the event of an accident in which airbags or belt pretensioners are deployed, the vehicle is automatically unlocked.

Unlocking



Press .

Two settings are selectable in the Info-Display:

- To unlock only the driver's door, press  once. To unlock all doors and load compartment, press  twice.
- Press  once to unlock all doors and load compartment.

The setting can be changed in the menu **Settings** in the Info-Display.

Vehicle personalisation ⇨ 86.

The setting can be saved for the key being used.

Memorised settings ⇨ 23.

Locking

Close doors and load compartment.



Press .

If the driver's door is not closed properly, the central locking system will not work.

Central locking buttons

Locks or unlocks doors and the load compartment from inside the passenger compartment.





Press  to lock.

Press  to unlock.

Fault in radio remote control system

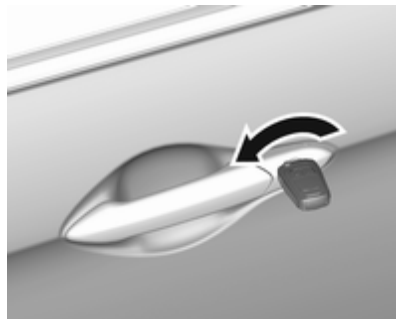
Unlocking



Manually unlock the driver's door by turning the key in the lock. Switch on the ignition and press the central locking button  to unlock the other doors and load compartment.

By switching on the ignition, the anti-theft alarm system is deactivated.

Locking

Close all doors. Open the driver's door and press the central locking button. The vehicle is locked.

Close the driver's door. Manually lock the driver's door by turning the key.

Fault in central locking system

Unlocking

Manually unlock the driver's door by turning the key in the lock. From the inside of the vehicle the doors can be unlocked by pulling up the lock button on the respective door. The load compartment cannot be unlocked.

Automatic door locking

If no door is opened or the position of ignition key is not located in position 1 or position 2 within three minutes after unlocking with the radio remote control, all the doors are locked and the anti-theft alarm system is activated automatically.

Child locks

Warning

Use the child locks whenever children are occupying the rear seats.



Move the pin in the rear door to the front. The door cannot be opened from inside.

Doors

Front doors

Central locking system

See Central locking system ⇨ 23.

Manual door locks

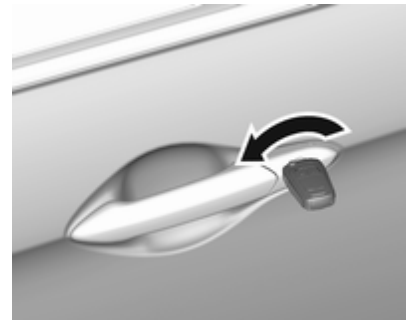

Unlock a front door by turning the key in the lock anti-clockwise. Pull the handle to open the door.

To lock the door, turn the key clockwise in the lock.

Rear doors

Central locking system

See Central locking system ⇨ 23.

Manual door locks



To unlock a rear door, pull the interior lock button on the respective door. Open the door by pulling the handle. Push the interior lock button down to lock the respective door.

Load compartment

Tailgate

Opening

Central locking system



To open the tailgate with all doors unlocked, push the touchpad switch on the underside of the tailgate handle and lift up the tailgate.

Manual door locks



To unlock the tailgate, insert the key into the lock and turn it anti-clockwise into a horizontal position. Lift the tailgate to open it.

Closing



Use interior handle to lower and close the tailgate.

Do not press the touchpad switch whilst closing as this will unlock the tailgate again.

Central locking system ⇨ 23.

Manual door locks

To lock the tailgate, insert the key into the lock and turn it clockwise into a vertical position.

General hints for operating tailgate

⚠ Danger

Do not drive with the tailgate open or ajar, e.g. when transporting bulky objects, since toxic exhaust gases, which cannot be seen or smelled, could enter the vehicle. This can cause unconsciousness and even death.

Caution

Before opening the tailgate, check overhead obstructions, e.g. a garage door, to avoid damage to the tailgate. Always check the moving area above and behind the tailgate.

Note

The installation of certain heavy accessories onto the tailgate may affect its ability to remain open.

Vehicle security

Anti-theft alarm system

It monitors:

- doors, tailgate, bonnet
- ignition

Status LED

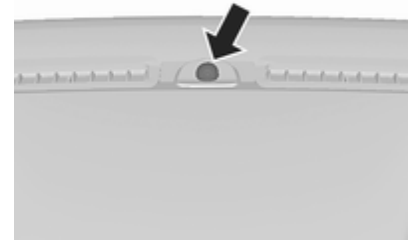

Status LED is integrated in the sensor on top of the instrument panel.

Status during the first 30 seconds of anti-theft alarm system activation:

LED illuminates : test, arming delay
 LED flashes : doors, tailgate or quickly bonnet not completely closed, or system fault

Seek the assistance of a workshop in the event of faults.

Deactivation

Unlocking the vehicle by pressing  deactivates anti-theft alarm system.

Alarm

When triggered, the alarm horn sounds and the hazard warning lights flash simultaneously. The number and duration of alarm signals are stipulated by legislation.

The alarm can be silenced by pressing any button on the radio remote control or by switching on the ignition.

The anti-theft alarm system can only be deactivated by pressing  on the radio remote control or by switching on the ignition.

Vehicle messages ⇨ 83.

If the vehicle's battery is to be disconnected (e.g. for maintenance work), the alarm siren must be deactivated as follows: Switch the ignition on then off, then disconnect the vehicle's battery within 15 seconds.

Immobiliser

The system is part of the ignition switch and checks whether the vehicle is allowed to be started with the key being used.

The immobiliser is activated automatically after the key has been removed from the ignition switch.

If the control indicator  flashes when the ignition is on, there is a fault in the system; the engine cannot be started. Switch off the ignition and repeat the start attempt.

If the control indicator continues flashing, attempt to start the engine using the spare key and seek the assistance of a workshop.

Note

The immobiliser does not lock the doors. You should always lock the vehicle after leaving it.

Switch on the anti-theft alarm system ⇨ 23, ⇨ 27.

Control indicator  ⇨ 76.

Exterior mirrors

Mirrors

The shape of the mirrors makes objects appear smaller, which will affect the ability to estimate distances.

Manual adjustment

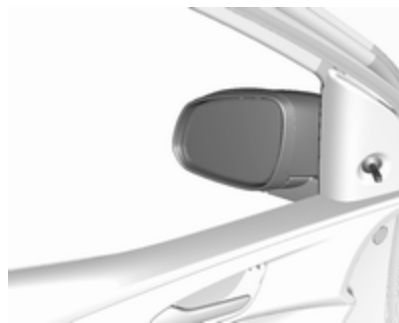

Adjust mirrors by swivelling lever in required direction.

Electric adjustment

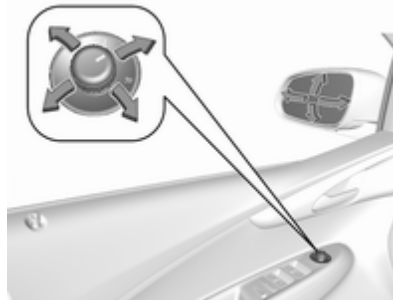

Select the relevant exterior mirror by turning the control to left (L) or right (R). Then swivel the control to adjust the mirror.

In position **0** no mirror is selected.

Folding mirrors

For pedestrian safety, the exterior mirrors will swing out of their normal mounting position if they are struck with sufficient force. Reposition the mirror by applying slight pressure to the mirror housing.



Heated mirrors

Type 1



Type 2



Operated by pressing .

Mirror heating works with the engine running.

It is switched off automatically after a short time.

Interior mirrors

Manual anti-dazzle

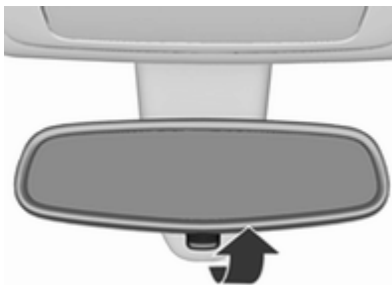

To reduce dazzle, adjust the lever on the underside of the mirror housing.

Windows

Windscreen

Windscreen stickers

Do not attach stickers, e.g. toll road stickers or similar, on the windscreen in the area of the interior mirror. Otherwise the detection zone of the sensor in the mirror housing could be restricted.

Windscreen replacement

Caution
If the vehicle has a front-looking camera sensor for the driver assistance systems, it is very important that any windscreen replacement is performed accurately according to Opel specifications. Otherwise, these systems may not work properly and there is a risk of unexpected behaviour and/or messages from these systems.

Manual windows

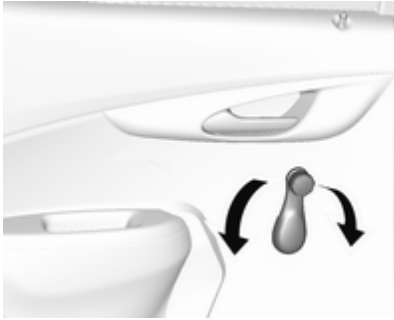

The windows can be opened or closed manually with the window cranks.

Power windows

Warning

Take care when operating the power windows. Risk of injury, particularly to children.

Be careful when closing the windows. Ensure that nothing becomes trapped in them as they move.

Operable with ignition on (position 2)
↔ 109.

Retained power off ↔ 110.

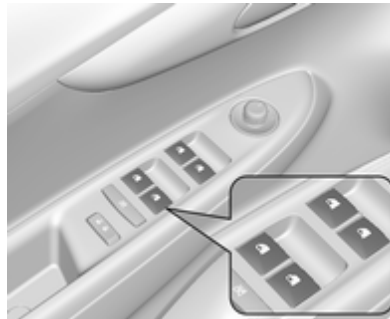

Operate the switch in the door trim for the respective window by pushing to open or pulling to close.

Open

Short push: window opens in stages.

Long push: window opens automatically up to end position. To stop movement, move switch in opposite direction.

Close

Short pull: window closes in stages.

Longer pull: window closes automatically up to end position. To stop movement, move switch in opposite direction.

Safety function



If the window glass encounters resistance above the middle of the window during automatic closing, it is immediately stopped and opened again.

Override safety function

In the event of closing difficulties due to frost or the like, switch on the ignition, then pull the switch several times to close the windows in stages.

Child safety system for rear windows



Press  to deactivate rear door power windows; the LED illuminates. To activate, press  again.

Overload

If the windows are repeatedly operated at short intervals, the window operation is disabled for some time.

Initialising the power windows

If the windows cannot be opened or closed automatically (e.g. after disconnecting the vehicle battery), activate the window electronics as follows:

1. Close the doors.
2. Switch on ignition.
3. Close the window completely and operate the button for an additional two seconds.
4. Repeat this procedure for each window.

Heated rear window

Type 1



Type 2

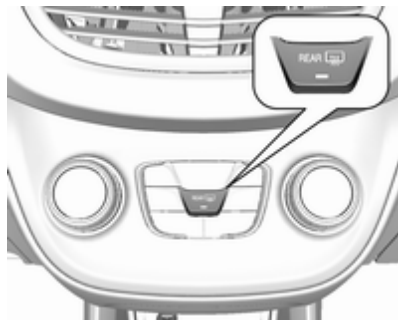

Operated by pressing .

Rear window heating works with the engine running.

It is switched off automatically after a short time.

Sun visors

The sun visors can be folded down or swivelled to the side to prevent dazzling.

The covers of the mirrors should be closed when driving.

Roof

Sunroof

Warning

Take care when operating the sunroof. Risk of injury, particularly to children.

Keep a close watch on the movable parts when operating them. Ensure that nothing becomes trapped in them as they move.

Operable via a rocker switch with ignition on (position 2) ⇨ 109.

Retained power off ⇨ 110.



Raise

Hold switch  depressed until the sunroof is raised at the rear.

Open

From raised position press and release switch : the sunroof is opened automatically up to end position. To stop movement before end position, operate switch once more.

Close

Hold switch  depressed from any position until sunroof is closed completely. Releasing the switch stops movement in any position.

Note

If the top of the roof is wet, tilt sunroof, allow water to run off and then open sunroof.

Do not affix any stickers to sunroof.

Sunblind

The sunblind is manually operated.

Close or open the sunblind by sliding.

When the sunroof is open, the sunblind is always open.

Seats, restraints

Head restraints	35
Front seats	36
Seat position	36
Seat adjustment	37
Heating	38
Seat belts	39
Three-point seat belt	40
Airbag system	41
Front airbag system	44
Side airbag system	45
Curtain airbag system	45
Airbag deactivation	46
Child restraints	47
Child restraint systems	47
Child restraint installation locations	50

Head restraints

Position

⚠ Warning

Only drive with the head restraint set to the proper position.



The upper edge of the head restraint should be at upper head level. If this is not possible for extremely tall people, set to highest position, and set to lowest position for small people.

Adjustment

Front head restraints, height adjustment



Press release button, adjust height, engage.

Rear head restraints, height adjustment



Pull the head restraint upwards and let engage. To move downwards, press the catch to release and push the head restraint downwards.

Removal of rear head restraint

E.g. when using a child restraint system ↻ 47.



Press both catches, pull the head restraint upwards and remove.

Front seats

Seat position

⚠ Warning

Only drive with the seat correctly adjusted.

⚠ Danger

Do not sit closer than 25 cm to the steering wheel, to permit safe airbag deployment.

⚠ Warning

Never adjust seats while driving as they could move uncontrollably.

⚠ Warning

Never store any objects under the seats.



- Sit with buttocks as far back against the backrest as possible. Adjust the distance between the seat and the pedals so that legs are slightly angled when fully pressing the pedals. Slide the front passenger seat as far back as possible.
- Set seat height high enough to have a clear field of vision on all sides and of all display instruments. There should be at least one hand of clearance between head and the roof frame. Your thighs should rest lightly on the seat without pressing into it.

- Sit with shoulders as far back against the backrest as possible. Set the backrest rake so that it is possible to easily reach the steering wheel with arms slightly bent. Maintain contact between shoulders and the backrest when turning the steering wheel. Do not angle the backrest too far back. We recommend a maximum rake of approx. 25°.
- Adjust seat and steering wheel in a way that the wrist rests on top of the steering wheel while the arm is fully extended and shoulders on the backrest.
- Adjust the steering wheel ↻ 61.
- Adjust the head restraint ↻ 35.
- Adjust the seat belt ↻ 40.

Seat adjustment

Drive only with engaged seats and backrests.

Longitudinal adjustment



Pull handle, slide seat, release handle. Try to move the seat back and forth to ensure that the seat is locked in place.

Backrest inclination



Pull lever, adjust inclination and release lever. Allow the backrest to engage audibly.

Seat height

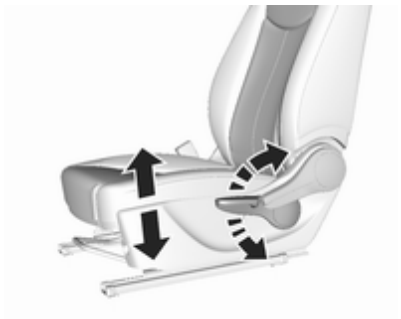

Lever pumping motion
up : seat higher
down : seat lower

Heating

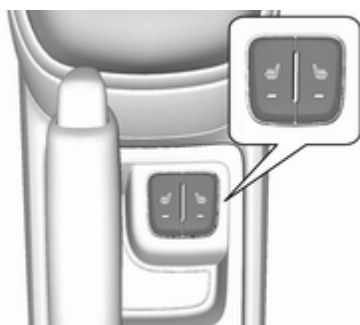

Activate seat heating by pressing  for the respective front seat.

The LED in the button illuminates to indicate activation.

Pressing  once more deactivates seat heating.

Seat heating is operational when engine is running.

During an Autostop, seat heating is also operational.

Stop-start system  111.

Seat belts



The seat belts are locked during heavy acceleration or deceleration of the vehicle holding the occupants in the sitting position. Therefore the risk of injury is considerably reduced.

⚠ Warning

Fasten seat belt before each trip. In the event of an accident, people not wearing seat belts endanger their fellow occupants and themselves.

Seat belts are designed to be used by only one person at a time. Child restraint system ⇨ 47.



Periodically check all parts of the belt system for damage, pollution and proper functionality.

Have damaged components replaced by a workshop. After an accident, have the belts and triggered belt pretensioners replaced by a workshop.

Note

Make sure that the belts are not damaged by shoes or sharp-edged objects or trapped. Prevent dirt from getting into the belt retractors.

Seat belt reminder

Front seats are equipped with a seat belt reminder, indicated for driver seat as control indicator  in the tachometer ⇨ 72, and for front passenger seat as control indicator  in the Driver Information Centre ⇨ 69.

Belt force limiters

Stress on the body is reduced by the gradual release of the belt during a collision.

Belt pretensioners

In the event of a head-on or rear-end collision of a certain severity, the front seat belts are tightened.

⚠ Warning

Incorrect handling (e.g. removal or fitting of belts) can trigger the belt pretensioners.

Deployment of the belt pretensioners is indicated by continuous illumination of control indicator  ⇨ 72.

Triggered belt pretensioners must be replaced by a workshop. Belt pretensioners can only be triggered once.

Note

Do not affix or install accessories or other objects that may interfere with the operation of the belt

pretensioners. Do not make any modifications to belt pretensioner components as this will invalidate the operating permit of your vehicle.

Three-point seat belt

Fasten



Withdraw the belt from the retractor, guide it untwisted across the body and insert the latch plate into the buckle. Tighten the lap belt regularly while driving by pulling the shoulder belt.



Loose or bulky clothing prevents the belt from fitting snugly. Do not place objects such as handbags or mobile phones between the belt and your body.

⚠ Warning

The belt must not rest against hard or fragile objects in the pockets of your clothing.

Seat belt reminder   72.

Unfasten



To release belt, press red button on belt buckle.

Using the seat belt while pregnant



⚠ Warning

The lap belt must be positioned as low as possible across the pelvis to prevent pressure on the abdomen.

Airbag system

The airbag system consists of a number of individual systems depending on the scope of equipment.

When triggered, the airbags inflate within milliseconds. They also deflate so quickly that it is often unnoticeable during the collision.

⚠ Warning

The airbag system deploys in an explosive manner, repairs must be performed by skilled personnel only.

Note

The airbag systems and belt pretensioner control electronics are located in the centre console area. Do not put any magnetic objects in this area.

Do not affix any objects onto the airbag covers and do not cover them with other materials. Have damaged covers replaced by a workshop.

Each airbag is triggered only once. Have deployed airbags replaced by a workshop. Furthermore, it may be necessary to have the steering wheel, the instrument panel, parts of the panelling, the door seals, handles and the seats replaced.

Do not make any modifications to the airbag system as this will invalidate the vehicle operating permit.

Fault

If there is a fault in the airbag system, the control indicator  illuminates and a message or a warning code appears in the Driver Information Centre. The system is not operational.

Have the cause of the fault remedied by a workshop.

Control indicator for airbag systems
↪ 72.

Child restraint systems on front passenger seat with airbag systems



EN: NEVER use a rearward-facing child restraint on a seat protected by an ACTIVE AIRBAG in front of it; DEATH or SERIOUS INJURY to the CHILD can occur.

DE: Nach hinten gerichtete Kindersitze NIEMALS auf einem Sitz verwenden, der durch einen davor befindlichen AKTIVEN AIRBAG geschützt ist, da dies den TOD oder SCHWERE VERLETZUNGEN DES KINDES zur Folge haben kann.

FR: NE JAMAIS utiliser un siège d'enfant orienté vers l'arrière sur un siège protégé par un COUSSIN GONFLABLE ACTIF placé devant lui, sous peine d'infliger des BLESSURES GRAVES, voire MORTELLES à l'ENFANT.

ES: NUNCA utilice un sistema de retención infantil orientado hacia atrás en un asiento protegido por un AIRBAG FRONTAL ACTIVO. Peligro de MUERTE o LESIONES GRAVES para el NIÑO.

RU: ЗАПРЕЩАЕТСЯ устанавливать детское удерживающее устройство лицом назад на сиденье автомобиля, оборудованном фронтальной подушкой безопасности, если ПОДУШКА НЕ ОТКЛЮЧЕНА! Это может привести к СМЕРТИ или СЕРЬЕЗНЫМ ТРАВМАМ РЕБЕНКА.

NL: Gebruik NOOIT een achterwaarts gericht kinderzitje op een stoel met een ACTIEVE AIRBAG ervoor, om DODELIJK of ERNSTIG LETSEL van het KIND te voorkomen.

DA: Brug ALDRIG en bagudvendt autostol på et forsæde med AKTIV AIRBAG, BARNET kan komme i LIVSFARE eller komme ALVORLIGT TIL SKADE.

SV: Använd ALDRIG en bakåtvänd barnstol på ett säte som skyddas med en framförvarande AKTIV AIRBAG. DÖDSFALL eller ALLVARLIGA SKADOR kan drabba BARNET.

FI: ÄLÄ KOSKAAN sijoita taaksepäin suunnattua lasten turvaistuinta istuimelle, jonka edessä on AKTIIVINEN TURVATYYNY, LAPSI VOI KUOLLA tai VAMMAUTUA VAKAVASTI.

NO: Bakovervendt barnesikringsutstyr må ALDRI brukes på et sete med AKTIV KOLLISJONSPUTE foran, da det kan føre til at BARNET utsettes for LIVSFARE og fare for ALVORLIGE SKADER.

PT: NUNCA use um sistema de retenção para crianças voltado para trás num banco protegido com um AIRBAG ACTIVO na frente do

mesmo, poderá ocorrer a PERDA DE VIDA ou FERIMENTOS GRAVES na CRIANÇA.

IT: Non usare mai un sistema di sicurezza per bambini rivolto all'indietro su un sedile protetto da AIRBAG ATTIVO di fronte ad esso: pericolo di MORTE o LESIONI GRAVI per il BAMBINO!

EL: ΠΟΤΕ μη χρησιμοποιείτε παιδικό κάθισμα ασφαλείας με φορά προς τα πίσω σε κάθισμα που προστατεύεται από μετωπικό ΕΝΕΡΓΟ ΑΕΡΟΣΑΚΟ, διότι το παιδί μπορεί να υποστεί ΘΑΝΑΣΙΜΟ ή ΣΟΒΑΡΟ ΤΡΑΥΜΑΤΙΣΜΟ.

PL: NIE WOLNO montować fotelika dziecięcego zwróconego tyłem do kierunku jazdy na fotelu, przed którym znajduje się WŁĄCZONA PODUSZKA POWIETRZNA. Niezastosowanie się do tego zalecenia może być przyczyną ŚMIERCI lub POWAŻNYCH OBRAŻEŃ u DZIECKA.

TR: Arkaya bakan bir çocuk emniyet sistemini KESİNLİKLE önünde bir AKTİF HAVA YASTIĞI ile korunmakta olan bir koltukta

kullanmayınız. ÇOCUK ÖLEBİLİR veya AĞIR ŞEKİLDE YARALANABİLİR.

UK: НИКОЛИ не використовуйте систему безпеки для дітей, що встановлюється обличчям назад, на сидінні з УВІМКНЕНОЮ ПОДУШКОЮ БЕЗПЕКИ, інакше це може призвести до СМЕРТІ чи СЕРІОЗНОГО ТРАВМУВАННЯ ДИТИНИ.

HU: SOHA ne használjon hátrafelé néző biztonsági gyerekléssel előlről AKTÍV LÉGSZÁKKAL védett ülésen, mert a GYERMEK HALÁLÁT vagy KOMOLY SÉRÜLÉSÉT okozhatja.

HR: NIKADA nemojte koristiti sustav zadržavanja za djecu okrenut prema natrag na sjedalu s AKTIVNIM ZRAČNIM JASTUKOM ispred njega, to bi moglo dovesti do SMRTI ili OZBILJNIH OZLJEDA za DIJETE.

SL: NIKOLI ne nameščajte otroškega varnostnega sedeža, obrnjenega v nasprotni smeri vožnje, na sedež z AKTIVNO ČELNO ZRAČNO BLAZINO, saj pri tem obstaja nevarnost RESNIH ali SMRTNIH POŠKODB za OTROKA.

SR: NIKADA ne koristiti bezbednosni sistem za decu u kome su deca okrenuta unazad na sedištu sa AKTIVNIM VAZDUŠNIM JASTUKOM ispred sedišta zato što DETE može da NASTRADA ili da se TEŠKO POVREDI.

MK: НИКОГАШ не користете детско седиште свртено наназад на седиште заштитено со АКТИВНО ВОЗДУШНО ПЕРНИЧЕ пред него, затоа што детето може ДА ЗАГИНЕ или да биде ТЕШКО ПОВРЕДЕНО.

BG: НИКОГА не използвайте детска седалка, гледаща назад, върху седалка, която е защитена чрез АКТИВНА ВЪЗДУШНА ВЪЗГЛАВНИЦА пред нея - може да се стигне до СМЪРТ или СЕРИОЗНО НАРАНЯВАНЕ на ДЕТЕТО.

RO: Nu utilizați NICIODATĂ un scaun pentru copil îndreptat spre partea din spate a mașinii pe un scaun protejat de un AIRBAG ACTIV în fața sa; acest lucru poate duce la DECESUL sau VĂTĂMAREA GRAVĂ a COPILULUI.

CS: NIKDY nepoužívejte dětský zádržný systém instalovaný proti směru jízdy na sedadle, které je chráněno před sedadlem AKTIVNÍM AIRBAGEM. Mohlo by dojít k VÁŽNÉMU PORANĚNÍ nebo ÚMRTÍ DÍTĚTE.

SK: NIKDY nepoužívajte detskú sedačku otočenú vzad na sedadle chránenom AKTÍVNÝM AIRBAGOM, pretože môže dôjsť k SMRTI alebo VÁŽNYM ZRANENIAM DIEŤAŤA.

LT: JOKIU BŪDU nemontuokite atgal atgręžtos vaiko tvirtinimo sistemas sėdynėje, prieš kurią įrengta AKTYVI ORO PAGALVĖ, nes VAIKAS GALI ŽŪTI arba RIMTAI SUSIŽALOTI.

LV: NEKĀDĀ GADĪJUMĀ neizmantojiet uz aizmuguri vērstu bērnu sēdekļīti sēdvietā, kas tiek aizsargāta ar tās priekšā uzstādītu AKTĪVU DROŠĪBAS SPILVENU, jo pretējā gadījumā BĒRNS var gūt SMAGAS TRAUMAS vai IET BOJĀ.

ET: ÄRGE kasutage tahapoolle suunatud lapseturvaistet istmel, mille ees on AKTIIVSE TURVAPADJAGA

kaitstud iste, sest see võib põhjustada LAPSE SURMA või TÕSISE VIGASTUSE.

MT: QATT tuża trażżin għat-tfal li jħares lejn in-naħa ta' wara fuq sit protett b' AIRBAG ATTIV quddiemu; dan jista' jikkawża l-MEWT jew ĠRIEHI SERJI lit-TFAL.

GA: Ná húsáid srian sábháilteachta línbh cúil RIAMH ar shuíochán a bhfuil mála aeir ag feidhmiú os a chomhair. Tá baol BÁIS nó GORTÚ DONA don PHÁISTE ag baint leis.

Beyond the warning required by ECE R94.02, for safety reasons a forward-facing child restraint system must only be used subject to the instructions and restrictions in the tables ⇨ 50.

The airbag label is located on both sides of the front passenger sun visor.

Airbag deactivation ⇨ 46.

Front airbag system

The front airbag system consists of one airbag in the steering wheel and one in the instrument panel on the front passenger side. The location is identified by the word **AIRBAG**.

The front airbag system is triggered in the event of a front-end impact of a certain severity. The ignition must be switched on.

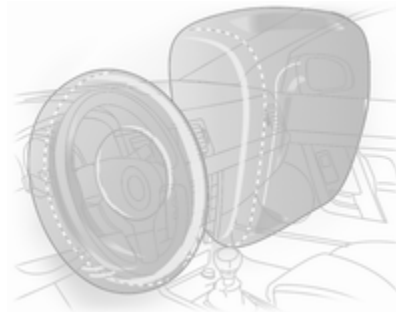

The inflated airbags cushion the impact, thereby reducing the risk of injury to the upper body and head of the front seat occupants considerably.

⚠ Warning

Optimum protection is only provided when the seat is in the proper position.

Seat position ⇨ 36.

Keep the area in which the airbag inflates clear of obstructions.

Fit the seat belt correctly and engage securely. Only then is the airbag able to protect.

Side airbag system

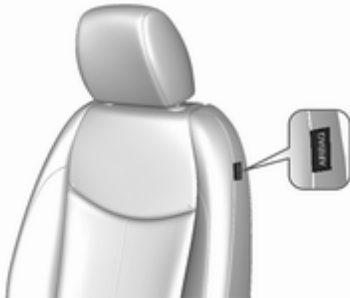

The side airbag system consists of an airbag in each front seat backrest. The location is identified by the word **AIRBAG**.

The side airbag system is triggered in the event of a side impact of a certain severity. The ignition must be switched on.

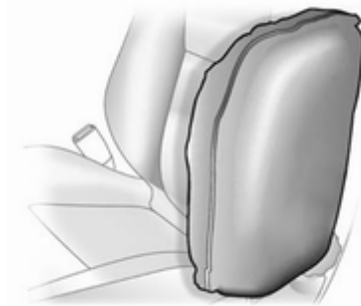

The inflated airbags cushion the impact, thereby reducing the risk of injury to the upper body and pelvis in the event of a side-on collision considerably.

⚠ Warning

Keep the area in which the airbag inflates clear of obstructions.

Note

Only use protective seat covers that have been approved for the vehicle. Be careful not to cover the airbags.

Curtain airbag system

The curtain airbag system consists of an airbag in the roof frame on each side. The location is identified by the word **AIRBAG** on the roof pillars.

The curtain airbag system is triggered in the event of a side-on impact of a certain severity. The ignition must be switched on.

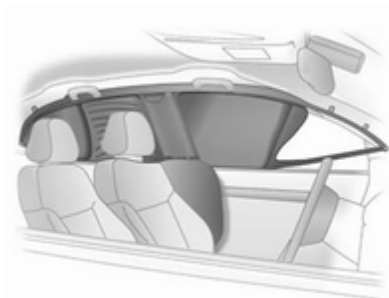

The inflated airbags cushion the impact, thereby reducing the risk of injury to the head in the event of a side-on impact considerably.

⚠ Warning

Keep the area in which the airbag inflates clear of obstructions.

The hooks on the handles in the roof frame are only suitable for hanging up light articles of clothing, without coat hangers. Do not keep any items in these clothes.

Airbag deactivation

The front passenger airbag system must be deactivated for a child restraint system on the passenger seat according to the instructions in the tables ⇨ 50.

The other airbag systems, the belt pretensioners and all driver airbag systems will remain active.

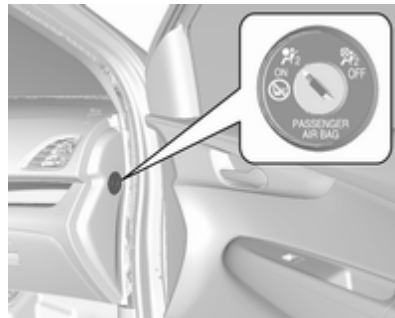

The front passenger airbag system can be deactivated via a key-operated switch on the passenger side of the instrument panel.

Use the ignition key to choose the switch position:

- OFF** : front passenger airbag is deactivated and will not inflate in the event of a collision. Control indicator **OFF** illuminates continuously
- ON** : front passenger airbag is active

⚠ Danger

Deactivate passenger airbag only in combination with the use of a child restraint system, subject to the instructions and restrictions in the tables ⇨ 50.

Otherwise, there is a risk of fatal injury for a person occupying a seat with a deactivated front passenger airbag.



Control indicator for airbag deactivation ⇨ 72.

If control indicator  illuminates for approx. 60 seconds after the ignition is switched on, the front passenger airbag system will inflate in the event of a collision.

If both control indicators are illuminated at the same time, there is a system failure. The status of the system is not discernible, therefore no person is allowed to occupy the front passenger seat. Contact a workshop immediately.

Change status only when the vehicle is stopped with the ignition off.

Status remains until the next change.

Child restraints

Child restraint systems

Danger

If using a rear-facing child restraint system on the front passenger seat, the airbag system for the front passenger seat must be deactivated. This also applies to certain forward-facing child restraint systems as indicated in the tables ⇨ 50.

Airbag deactivation ⇨ 46.

Airbag label ⇨ 41.

We recommend a child restraint system which is tailored specifically to the vehicle. For further information, contact your workshop.

When a child restraint system is being used, pay attention to the following usage and installation instructions as well as to those supplied with the child restraint system.

Always comply with local or national regulations. In some countries, the use of child restraint systems is forbidden on certain seats.

Child restraint systems can be fastened with:

- Three-point seat belt
- ISOFIX brackets
- Top-tether anchor

Three-point seat belt

Child restraint systems can be fastened by using a three-point seat belt ⇨ 50.

ISOFIX brackets



Fasten vehicle-approved ISOFIX child restraint systems to the ISOFIX mounting brackets. Specific vehicle ISOFIX child restraint system positions are marked in the table by IL.

ISOFIX mounting brackets are indicated by a ISOFIX label on the backrest.

ISOFIX child restraint systems of universal category positions are marked in the table by IUF.

Either a Top-tether strap or a support leg must be used in addition to the ISOFIX mounting brackets.

Remove rear head restraint before mounting a child restraint system, if required ⇨ 35.

Top-tether anchors

Top-tether anchors are marked with the symbol  for a child seat.

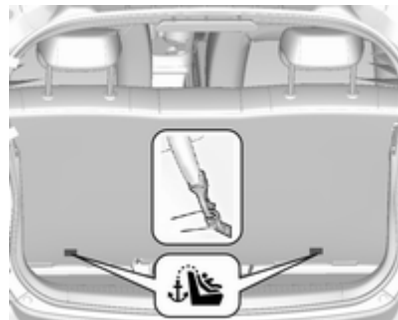

In addition to the ISOFIX mounting brackets, fasten the Top-tether strap to the Top-tether anchors.

ISOFIX child restraint systems of universal category positions are marked in the table by IUF ⇨ 50.

Remove rear head restraint before mounting a child restraint system, if required ⇨ 35.

Selecting the right system

The rear seats are the most convenient location to fasten a child restraint system.

Children should travel facing rearwards in the vehicle as long as possible. This ensures that the child's backbone, which is still very weak, is under less strain in the event of an accident.

Suitable are restraint systems that comply with valid UN ECE regulations. Check local laws and regulations for mandatory use of child restraint systems.

Ensure that the child restraint system to be installed is compatible with the vehicle type.

Refer to the tables on the following pages, the instructions supplied with the child restraint system and the vehicle type list of non-universal child restraint systems.

The following child restraints are recommended for the following weight classes:

- **Group 0, Group 0+**

Maxi Cosi Cabriofix with ISOFIX base, for children up to 13 kg

- **Group I**

Duo Plus with ISOFIX and Top tether, for children from 9 kg to 18 kg in this group

- **Group II, Group III**

Kidfix XP with or without ISOFIX for children from 15 kg to 36 kg

Nania / OSANN Dream Booster with or without ISOFIX for children from 22 kg to 36 kg

Ensure that the mounting location of the child restraint system within the vehicle is correct, see following tables.

Allow children to enter and exit the vehicle only on the side facing away from the traffic.

When the child restraint system is not in use, secure the seat with a seat belt or remove it from the vehicle.

Note

Do not affix anything on the child restraint systems and do not cover them with any other materials.

A child restraint system which has been subjected to stress in an accident must be replaced.

Child restraint installation locations

Permissible options for fastening a child restraint system with a three-point seat belt

Weight class	On front passenger seat		On rear outboard seats	On rear centre seat
	activated airbag	deactivated airbag		
Group 0: up to 10 kg	X	U ¹	U ²	X
Group 0+: up to 13 kg	X	U ¹	U ²	X
Group I: 9 to 18 kg	X	U ¹	U ^{2, 3}	X
Group II: 15 to 25 kg	X	X	U ^{2, 3}	X
Group III: 22 to 36 kg	X	X	U ^{2, 3}	X

U : universal suitability in conjunction with three-point seat belt

X : no child restraint system permitted in this weight class

- ¹ : adjust seat backrest as far as necessary to a vertical position to ensure that the belt runs forwards from the upper anchorage point
- ² : move the driver and/or passenger seat forwards and adjust seat backrest as far as necessary to a vertical position to ensure that the child restraint system does not have any interference from the front seat backrest.
- ³ : adjust the respective headrest as necessary or remove if required.

Permissible options for fitting an ISOFIX child restraint system

Weight class	Size class	Fixture	On front passenger seat	On rear outboard seats	On rear centre seat
Group 0: up to 10 kg	F	ISO/L1	X	X	X
	G	ISO/L2	X	X	X
	E	ISO/R1	X	IL ¹	X
Group 0+: up to 13 kg	E	ISO/R1	X	IL ¹	X
	D	ISO/R2	X	IL ¹	X
	C	ISO/R3	X	IL ¹	X
Group I: 9 to 18 kg	D	ISO/R2	X	IL ^{1,2}	X
	C	ISO/R3	X	IL ^{1,2}	X
	B	ISO/F2	X	IL, IUF ^{1,2}	X
	B1	ISO/F2X	X	IL, IUF ^{1,2}	X
	A	ISO/F3	X	IL, IUF ^{1,2}	X
Group II: 15 to 25 kg			X	IL ^{1,2}	X
Group III: 22 to 36 kg			X	IL ^{1,2}	X

IL : suitable for particular ISOFIX restraint systems of the "specific-vehicle", "restricted" or "semi-universal" categories.
The ISOFIX restraint system must be approved for the specific vehicle type (refer to the vehicle type list of the child restraint system)

IUF : suitable for ISOFIX forward-facing child restraint systems of universal category approved for use in this weight class

- X : no ISOFIX child restraint system approved for this weight class
1 : only applicable for rear outer seat on passenger side with foremost seating position and backrest upright.
2 : adjust the respective headrest as necessary or remove if required.

Note

Move the driver and/or passenger seat forwards and adjust seat backrest inclination as far as necessary to a vertical position to ensure that the child restraint system does not have any interference from the front seat backrest.

ISOFIX size class and seat device

- A – ISO/F3 : forward-facing child restraint system for children of maximum size in the weight class 9 to 18 kg
B – ISO/F2 : forward-facing child restraint system for smaller children in the weight class 9 to 18 kg
B1 – ISO/F2X : forward-facing child restraint system for smaller children in the weight class 9 to 18 kg
C – ISO/R3 : rear-facing child restraint system for children of maximum size in the weight class up to 18 kg
D – ISO/R2 : rear-facing child restraint system for smaller children in the weight class up to 18 kg
E – ISO/R1 : rear-facing child restraint system for young children in the weight class up to 13 kg
F – ISO/L1 : left lateral facing position CRS (carry cot) for smaller children in the weight class up to 10 kg
G – ISO/L2 : right lateral facing position CRS (carry cot) for smaller children in the weight class up to 10 kg.

Permissible options for fitting an i-size child restraint system with ISOFIX brackets**On front passenger seat**

	activated airbag	deactivated airbag	On rear outboard seats	On rear centre seat
i-size child restraint systems	X	X	X	X

i - U : suitable for i-size 'universal' forward and rearward facing child restraint systems

X : seating position not suitable for i-size 'universal' child restraint systems

Storage

Storage compartments	53
Glovebox	53
Cupholders	53
Centre console storage	54
Load compartment	54
Load compartment cover	56
Rear floor storage cover	57
Warning triangle	57
First aid kit	58
Roof rack system	58
Roof rack	58
Loading information	59

Storage compartments

⚠ Warning

Do not store heavy or sharp objects in the storage compartments. Otherwise, the storage compartment lid could open and vehicle occupants could be injured by objects being thrown around in the event of hard braking, a sudden change in direction or an accident.

Glovebox



Pull lever to open the glovebox cover. The glovebox features an adapter for the locking wheel bolts.

The glovebox should be closed whilst driving.

Cupholders



Cupholders are located in the centre console.

Centre console storage



The storage is used for small articles.

Load compartment

Load compartment extension

Caution

First fold up the rear seat cushion before folding the rear seat backrest.

Disregard may lead to damage to the rear seat.

Note

To ensure sufficient room for rear seat cushion operation, slide the front seats forward and move the front seat backrest upright.



1. Pull up the front of the rear seat cushion to release it.
2. Guide the rear of the rear seat cushion to an upright position.
3. Remove the rear seat head restraints ↪ 35.

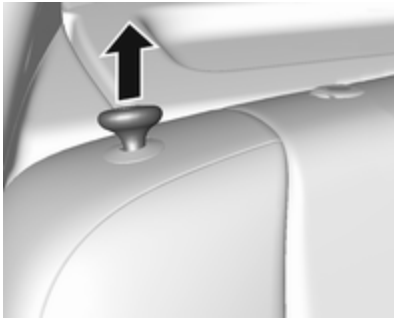

4. Pull the release knob on top of the rear backrest.



5. Fold down the backrest and insert the rear seat head restraints into the pockets.



6. Put the seat belts for the outboard seats into the belt guides.
7. Adjust the front seats to the desired position.

To return the backrest to the original position:

1. Lift the backrest up and pull out the seat belt from the belt guides. Push backrest firmly into place.

⚠ Warning

When folding up, ensure that backrests are securely engaged in position before driving. Failure to do so may result in personal injury

or damage to the load or vehicle in the event of hard braking or a collision.

- Ensure the seat belts are not pinched by the latch.
2. Reinstall the rear head restraints.
3. Place the rear part of the seat cushion in its original position.

Note

Make sure the seat belts are not twisted or caught under the seat cushion.

4. Push the front part of the seat cushion down firmly until it latches.

The centre rear seat belt may lock when you raise the backrest. If this happens, allow the belt to go back all the way and repeat operation.

If the seat belt is still locked, fold down the seat cushion and try again.

To return the rear seat cushion, put the rear part of the seat cushion in its original position ensuring that the seat belt buckle straps are not twisted

or caught under the seat cushion, then push the front part of the seat cushion firmly down until it latches.

Caution

When returning rear seat backrest to the upright position, place the rear seat belt and buckles between the rear seat backrest and one cushion. Make sure the rear seat belt and buckles do not get pinched under the rear seat cushion.

Ensure the seat belts are not twisted or caught in the seat backrest and are arranged in their proper position.

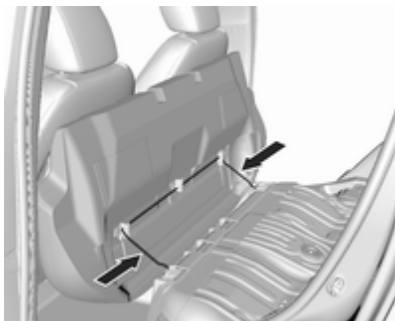

To remove the rear seat cushion, push the hinges in direction of arrow.

Load compartment cover

Do not place heavy objects on the cover.

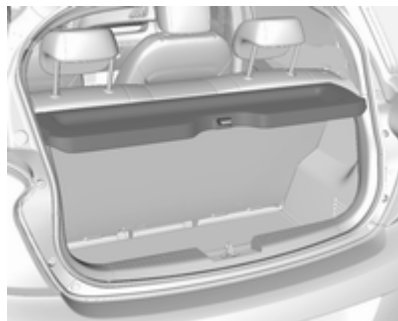

Removing

Lift cover at the rear and push it upwards at the front.

Remove the cover.

Stowing

When the load compartment is fully loaded, stow the load compartment cover on the rear seats or remove from vehicle.

Fitting

Engage cover in side guides and fold downwards. Attach retaining straps to tailgate.

Rear floor storage cover

Rear floor cover



Lift up rear floor cover to gain access to the tyre repair kit, vehicle tools and warning triangle.

On versions with spare wheel, the spare wheel is located under the rear floor cover together with the vehicle tools.

Tools ⇨ 155.

General hint

⚠ Warning

For safety reasons, stow all parts in the load compartment in its position, always drive with a closed rear floor cover and, if possible, with folded up rear backrests.

Otherwise, vehicle occupants could be injured by objects being thrown around in the event of sharp braking, a sudden change in direction or an accident.

Warning triangle

Vehicles with spare wheel

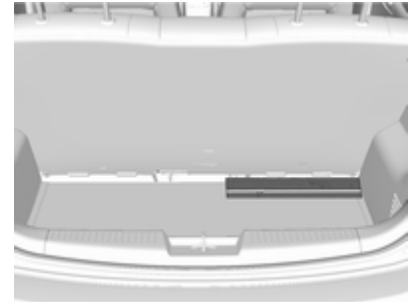

Stow the warning triangle in the load compartment.

Vehicles with tyre repair kit



Stow the warning triangle in the vehicle tool box below the floor over in the load compartment.

First aid kit



Stow the first-aid kit in the load compartment.

Roof rack system

Roof rack

For safety reasons and to avoid damage to the roof, the vehicle approved roof rack system is recommended. For further information contact your workshop.

Mount the roof rack to the roof rails following the installation instructions delivered with the roof rack.

Remove the roof rack when not in use.

Loading information

- Heavy objects in the load compartment should be placed against the seat backrests. Ensure that the backrests are securely engaged. If objects can be stacked, heavier objects should be placed at the bottom.
- Secure loose objects in the load compartment to prevent them from sliding.
- When transporting objects in the load compartment, the backrests of the rear seats must not be angled forward.
- Do not allow the load to protrude above the upper edge of the backrests.
- Do not place any objects on the load compartment cover or the instrument panel, and do not cover the sensor on top of the instrument panel.
- The load must not obstruct the operation of the pedals, parking brake and gear selector lever, or

hinder the freedom of movement of the driver. Do not place any unsecured objects in the interior.

- Do not drive with an open load compartment.

Warning

Always make sure that the load in the vehicle is securely stowed. Otherwise objects can be thrown around inside the vehicle and cause personal injury or damage to the load or vehicle.

- The payload is the difference between the permitted gross vehicle weight (see identification plate ⇨ 180) and the EC kerb weight.

To calculate the payload, enter the data for your vehicle in the weights table at the front of this manual.

The EC kerb weight includes weights for the driver (68 kg), luggage (7 kg) and all fluids (fuel tank 90% full).

Optional equipment and accessories increase the kerb weight.

- Driving with a roof load increases the sensitivity of the vehicle to cross-winds and has a detrimental effect on vehicle handling due to the vehicle's higher centre of gravity. Distribute the load evenly and secure it properly with retaining straps. Adjust the tyre pressure and vehicle speed according to the load conditions. Check and retighten the straps frequently. The permissible roof load for vehicles with roof railing is 50 kg. The roof load is the combined weight of the roof rack and the load.

Instruments and controls

Controls	61
Steering wheel adjustment	61
Steering wheel controls	61
Heated steering wheel	61
Horn	62
Windscreen wiper/washer	62
Rear window wiper/washer	63
Outside temperature	63
Clock	63
Power outlets	65
Cigarette lighter	65
Ashtrays	65
Warning lights, gauges and indicators	65
Instrument cluster	65
Speedometer	65
Odometer	66
Trip odometer	66
Tachometer	66
Fuel gauge	66
Fuel selector	67
Engine coolant temperature gauge	68
Service display	68

Control indicators	69
Turn signal	71
Seat belt reminder	72
Airbag and belt tensioners	72
Airbag deactivation	72
Charging system	73
Malfunction indicator light	73
Service vehicle soon	73
Brake and clutch system	73
Operate pedal	73
Antilock brake system (ABS)	74
Gear shifting	74
Power steering	74
Lane departure warning	74
Ultrasonic parking assist	74
Electronic Stability Control off	74
Electronic Stability Control and Traction Control system	74
Traction Control system off	75
Engine coolant temperature	75
Tyre pressure monitoring system	75
Engine oil pressure	75
Low fuel	76
Immobiliser	76
Reduced engine power	76
Exterior light	76
High beam	76
Fog light	76
Rear fog light	76

Cruise control	76
Speed limiter	76
Bonnet open	76
Door open	77
Information displays	77
Driver Information Centre	77
Info display	82
Vehicle messages	83
Warning chimes	85
Battery voltage	85
Vehicle personalisation	86
Telematics service	88
OnStar	88

Controls

Steering wheel adjustment

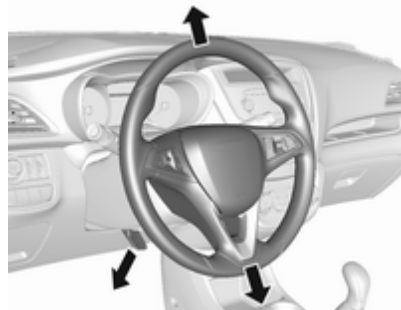

Unlock lever, adjust steering wheel, then engage lever and ensure it is fully locked.

Do not adjust steering wheel unless vehicle is stationary and steering wheel lock has been released.

Steering wheel controls





Driver Information Centre, some driver assistance systems, Infotainment system and a connected mobile phone can be operated via the controls on the steering wheel.

Driver assistance systems ↗ 124.

Further information is available in the Infotainment manual.

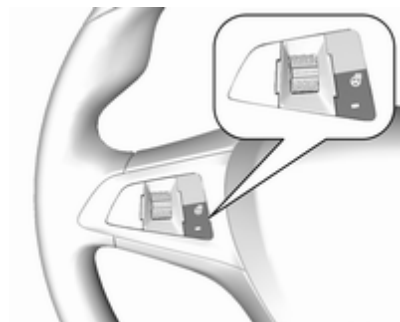
Heated steering wheel



Activate heating by pressing . Activation is indicated by the LED in the button.



The grip areas of the steering wheel are heated quicker and to a higher temperature than the other areas.

Heating is operational when the engine is running and during an Autostop.

Stop-start system ⇨ 111.

Horn





Press .

Windscreen wiper/washer

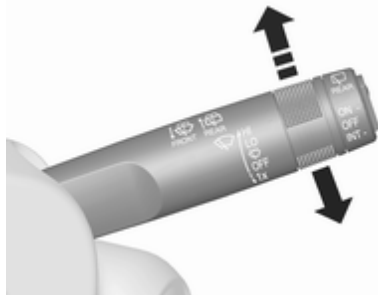
Windscreen wiper



HI : fast
LO : slow
 : interval wiping
OFF : off

For a single wipe when the windscreen wiper is off, press the lever down to position .

Do not use if the windscreen is frozen.

Switch off in car washes.

Windscreen washer

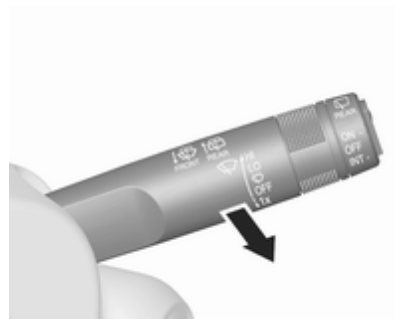

Pull lever. Washer fluid is sprayed onto the windscreen and the wiper wipes a few times.

Washer fluid ⇨ 141

Rear window wiper/washer



Press the rocker switch to activate the rear window wiper:

- upper position : continuous operation
- lower position : intermittent operation
- middle position : off

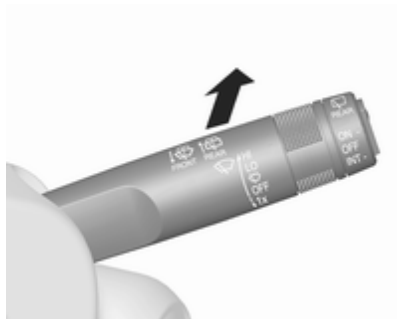

Push lever. Washer fluid is sprayed onto the rear window and the wiper wipes a few times.

Do not use if the rear window is frozen.

Switch off in car washes.

The rear window wiper comes on automatically when the windscreen wiper is switched on and reverse gear is engaged.

Activation or deactivation of this function can be changed in the menu **Settings** in the Info-Display.

Washer fluid ↻ 141

Vehicle personalisation ↻ 86.

Outside temperature

A drop in temperature is indicated immediately and a rise in temperature after a time delay.



Warning

The road surface may already be icy even though the display indicates a few degrees above 0 °C.

Clock

Date and time are shown in the Info-Display.

Info-Display ↻ 82

Graphic-Info-Display

Press **MENU** to open the respective audio menu.

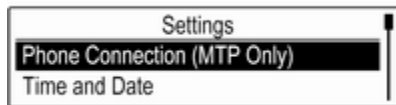

Select **Time and Date**.

Set Time

Select **Set Time** to enter the respective submenu.

Select **Auto Set** at the bottom of the screen. Activate either **On - RDS** or **Off (Manual)**.

If **Off (Manual)** is selected, adjust hours and minutes.

Repeatedly select **12-24 HR** at the bottom of the screen to choose a time mode.

If the 12-hour mode is selected, a third column for AM and PM selection is displayed. Select the desired option.

Set Date

Select **Set Date** to enter the respective submenu.

Select **Auto Set** at the bottom of the screen. Activate either **On - RDS** or **Off (Manual)**.

If **Off (Manual)** is selected, adjust the date settings.

7" Colour-Info-Display

Press  and then select **Settings**.

Select **Time and Date** to display the respective submenu.

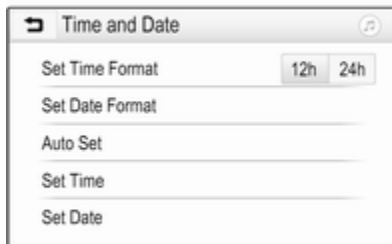

Set Time Format

To select the desired time format, touch the screen buttons **12 h** or **24 h**.

Set Date Format

To select the desired date format, select **Set Date Format** and choose between the available options in the submenu.

Auto Set

To choose whether time and date are to be set automatically or manually, select **Auto Set**.

For time and date to be set automatically, select **On - RDS**.

For time and date to be set manually, select **Off - Manual**. If **Auto Set** is set to **Off - Manual**, the submenu items **Set Time** and **Set Date** become available.

Set time and date

To adjust the time and date settings, select **Set Time** or **Set Date**.

Touch **+** and **-** to adjust the settings.

Power outlets



A 12 Volt power outlet is located in the centre console.

Do not exceed the maximum power consumption of 120 watts.

With ignition off, the power outlet is deactivated. Additionally, the power outlet is deactivated in the event of low vehicle battery voltage.

Electrical accessories that are connected must comply with the electromagnetic compatibility requirements laid down in DIN VDE 40 839.

Do not connect any current-delivering accessories, e.g. electrical charging devices or batteries.

Do not damage the outlet by using unsuitable plugs.

Stop-start system ⇨ 111.

Cigarette lighter

The cigarette lighter may be located in the centre console.

Press in cigarette lighter. It switches off automatically once the element is glowing. Pull out lighter.

Ashtrays

Caution
To be used only for ash and not for combustible rubbish.

The portable ashtray can be placed in the cupholders.

Warning lights, gauges and indicators

Instrument cluster

The needles of the instruments briefly rotate to the end position when the engine is being switched on.

Speedometer

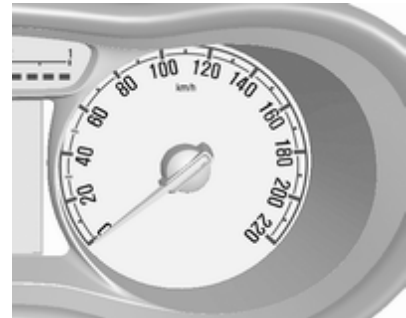

Indicates vehicle speed.

Odometer



The bottom line displays the recorded distance in km.

Trip odometer

The recorded distance is displayed since the last reset.

Trip odometer counts up to 9999.9 km and then restarts at 0.

To reset, press **SET/CLR** on the turn signal lever for a few seconds
 ⇨ 77.

Tachometer



Displays the engine speed.

Drive in a low engine speed range for each gear as much as possible.

Caution

If the needle is in the red warning zone, the maximum permitted engine speed is exceeded. Engine at risk.

Fuel gauge

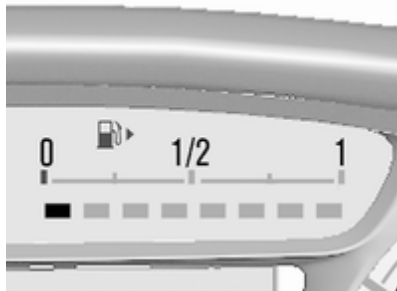

Number of LEDs displays the level in the fuel tank.

The arrow indicates the vehicle side where the fuel filler flap is located.

During liquid gas operation, the level in the gas tank is displayed.



Control indicator  illuminates if the level in the tank is low. Refuel immediately if it flashes.

During liquid gas operation, the system automatically switches over to petrol operation when gas tanks are empty \rightarrow 67.

Never run the fuel tank dry.

Because of the fuel remaining in the tank, the top-up quantity may be less than the specified tank capacity.

Fuel selector



Press **LPG** to switch between petrol and liquid gas operation. The LED in the button shows the current operating mode.

LED off : petrol operation
 LED : checking conditions for fuel transition to liquid gas operation.
 Illuminates if conditions are fulfilled.

LED illuminates : liquid gas operation
 LED flashes five times and extinguishes : liquid gas tank is empty or failure in liquid gas system. A message is displayed in the Driver Information Centre.

As soon as the liquid gas tank is empty, petrol operation is automatically engaged until the ignition is switched off.

Fuel for liquid gas operation \rightarrow 130.

Engine coolant temperature gauge



Number of LEDs displays the coolant temperature.

- up to 2 LEDs : engine operating temperature not yet reached
- 3 to 6 LEDs : normal operating temperature
- more than 6 LEDs : temperature too high

Caution

If engine coolant temperature is too high, stop vehicle, switch off engine. Danger to engine. Check coolant level.

Service display

The engine oil life system lets you know when to change the engine oil and filter. Based on driving conditions, the interval at which an engine oil and filter change will be indicated can vary considerably.



The remaining engine oil life duration is displayed in percent in the Driver Information Centre.

To display the remaining engine oil life duration use turn signal lever buttons:



Press **MENU** to select the **Vehicle Information Menu**.

Turn the adjuster wheel to select **Remaining Oil Life**.

Reset

Press **SET/CLR** on turn signal lever for several seconds to reset. The remaining engine oil life duration menu must be active. Switch on ignition, but not the engine.

The system must be reset every time the engine oil is changed to ensure proper functionality. Seek the assistance of a workshop.

Next service

When the system has calculated that engine oil life has diminished, a warning message appears in the Driver Information Centre. Have engine oil and filter changed by a workshop within one week or 500 km (whichever occurs first).

Driver Information Centre ↗ 77.

Service information ↗ 175.

Control indicators

The control indicators described are not present in all vehicles. The description applies to all instrument versions.

Depending on the equipment, the position of the control indicators may vary. When the ignition is switched on, most control indicators will illuminate briefly as a functionality test.

The control indicator colours mean:

- red : danger, important reminder
- yellow : warning, information, fault
- green : confirmation of activation
- blue : confirmation of activation
- white : confirmation of activation

Control indicators in the instrument cluster



Control indicators in the overhead console



Overview

- ↔ Turn signal ⇨ 71
- 🚗 Seat belt reminder ⇨ 72
- 🚗 Airbag and belt tensioners ⇨ 72
- 🚗 Airbag deactivation ⇨ 72
- 🔌 Charging system ⇨ 73
- 🚗 Malfunction indicator light ⇨ 73
- 🚗 Service vehicle soon ⇨ 73

- 🚗 Brake and clutch system ⇨ 73
- 🚗 Operate pedal ⇨ 73
- 🚗 Antilock brake system (ABS) ⇨ 74
- 🚗 Uphshift ⇨ 74
- 🚗 Power steering ⇨ 74
- 🚗 Lane departure warning ⇨ 74
- 🚗 Ultrasonic parking assist ⇨ 74
- 🚗 Electronic Stability Control off ⇨ 74
- 🚗 Electronic Stability Control and Traction Control system ⇨ 74
- 🚗 Traction Control system off ⇨ 75
- 🚗 Engine coolant temperature ⇨ 75
- 🚗 Tyre pressure monitoring system ⇨ 75
- 🚗 Engine oil pressure ⇨ 75

- 🚗 Low fuel ⇨ 76
- 🚗 Immobiliser ⇨ 76
- 🚗 Reduced engine power ⇨ 76
- 🚗 Exterior light ⇨ 76
- 🚗 High beam ⇨ 76
- 🚗 Fog light ⇨ 76
- 🚗 Rear fog light ⇨ 76
- 🚗 Cruise control ⇨ 76
- 🚗 Speed limiter ⇨ 76
- 🚗 Bonnet open ⇨ 76
- 🚗 Door open ⇨ 77

Turn signal

↔ illuminates or flashes green.

Illuminates briefly

The parking lights are switched on.

Flashes

A turn signal or the hazard warning flashers are activated.

Rapid flashing: failure of a turn signal light or associated fuse.

Bulb replacement ⇨ 144, Fuses ⇨ 150.

Turn signals ⇨ 95.

Seat belt reminder

Seat belt reminder on front seats

🚗 for driver's seat illuminates or flashes red in the speedometer.



🚗² for front passenger seat illuminates or flashes red in the overhead console when the seat is occupied.

Illuminates

After the ignition has been switched on, until the seat belt has been fastened.

Flashes

After having started the engine, for a maximum of 100 seconds, until the seat belt has been fastened.

Fastening the seat belt ⇨ 40.

Seat belt status on rear seats

🚗 in the Driver Information Centre flashes or illuminates.

Illuminates

After having started the engine for a minimum of 35 seconds, until the seat belt has been fastened.

Flashes

After starting-off, when the seat belt is unfastened.

Fastening the seat belt ⇨ 40.

Airbag and belt tensioners

🚗 illuminates red.

When the ignition is switched on, the control indicator illuminates for approx. four seconds. If it does not illuminate, does not go out after four seconds or illuminates whilst driving, there is a fault in the airbag system. Seek the assistance of a workshop. The airbags and belt pretensioners may fail to trigger in the event of an accident.

Deployment of the belt pretensioners or airbags is indicated by continuous illumination of 🚗.

⚠ Warning

Have the cause of the fault remedied immediately by a workshop.

Belt pretensioners, airbag system ⇨ 39, ⇨ 41.

Airbag deactivation

🚗^{ON} illuminates yellow.

The front passenger airbag is activated.

🚗^{OFF} illuminates yellow.

The front passenger airbag is deactivated ⇨ 46.

Danger

Risk of fatal injury for a child using a child restraint system together with activated front passenger airbag.

Risk of fatal injury for an adult person with deactivated front passenger airbag.

Charging system

 illuminates red.

Illuminates when the ignition is switched on and extinguishes shortly after the engine starts.

Illuminates when the engine is running

Stop, switch off engine. Vehicle battery is not charging. Engine cooling may be interrupted. The brake servo unit may cease to be effective. Seek the assistance of a workshop.

Malfunction indicator light

 illuminates or flashes yellow.

Illuminates when the ignition is switched on and extinguishes shortly after the engine starts.

Illuminates when the engine is running

Fault in the emission control system. The permitted emission limits may be exceeded. Seek the assistance of a workshop immediately.

Flashes when the engine is running

Fault that could lead to catalytic converter damage. Ease up on the accelerator until the flashing stops. Seek the assistance of a workshop immediately.

Service vehicle soon

 illuminates yellow.

Additionally, a warning code is displayed in the Driver Information Centre.

The vehicle requires a service.

Seek the assistance of a workshop. Vehicle messages ⇨ 83.

Brake and clutch system

 illuminates red.

The brake and clutch fluid level is too low, when manual parking brake is not applied ⇨ 142.

Warning

Stop. Do not continue your journey. Consult a workshop.

Illuminates when the manual parking brake is applied and ignition is switched on ⇨ 120.

Operate pedal

 illuminates or flashes yellow.

Illuminates

Clutch pedal must be depressed to start the engine in Autostop mode. Stop-start system ⇨ 111.

Flashes

Pedal must be depressed to start the engine with the key ⇨ 18, ⇨ 110.

Antilock brake system (ABS)

 illuminates yellow.

Illuminates for a few seconds after the ignition is switched on. The system is ready for operation when the control indicator extinguishes.

If the control indicator does not go out after a few seconds, or if it illuminates while driving, there is a fault in the ABS. The brake system remains operational but without ABS regulation.

Antilock brake system ⇨ 119.

Gear shifting

 with the number of a higher gear is indicated, when upshifting is recommended for fuel saving reasons.

Power steering

 illuminates yellow.

Illuminates with power steering disabled

Failure in the power steering system. Consult a workshop.

Illumination of and simultaneously

Power steering system must be calibrated, system calibration ⇨ 123.

Lane departure warning

 illuminates green or flashes yellow.

Illuminates green

System is switched on and ready to operate.

Flashes yellow

System recognises an unintended lane change.

Lane departure warning ⇨ 128.

Ultrasonic parking assist

 illuminates yellow.

Fault in system

or

Fault due to sensors that are dirty or covered by ice or snow

or

Interference due to external sources of ultrasound. Once the source of interference is removed, the system will operate normally.

Have the cause of the fault in the system remedied by a workshop.

Ultrasonic parking assist ⇨ 127.

Electronic Stability Control off

 illuminates yellow.

The system is deactivated.

Electronic Stability Control and Traction Control system

 flashes or illuminates yellow.

Flashes

The system is actively engaged. Engine output may be reduced and the vehicle may be braked automatically to a small degree.

Illuminates

A fault in the system is present. A warning code appears in the Driver Information Centre. Continued driving is possible. The system is not operational. Driving stability, however, may deteriorate depending on road surface conditions.

Have the cause of the fault remedied by a workshop.

Electronic Stability Control ⇨ 122,
Traction Control system ⇨ 121.

Traction Control system off

 illuminates yellow.

The system is deactivated.

Engine coolant temperature

 illuminates red.

Illuminates when the engine is running

Stop, switch off engine.

Caution
Coolant temperature too high.

Coolant temperature too high.

Check coolant level ⇨ 141.

If there is sufficient coolant, consult a workshop.

Tyre pressure monitoring system

 illuminates or flashes yellow.

Illuminates

Tyre pressure loss. Stop immediately and check tyre pressure.

Flashes

Fault in system or tyre without pressure sensor mounted (e.g. spare wheel). After 60-90 seconds the control indicator illuminates continuously. Consult a workshop.

Tyre pressure monitoring system
⇨ 157.

Engine oil pressure

 illuminates red.

Illuminates when the ignition is switched on and extinguishes shortly after the engine starts.

Illuminates when the engine is running

Caution
Engine lubrication may be interrupted. This may result in damage to the engine and/or locking of the drive wheels.

Engine lubrication may be interrupted. This may result in damage to the engine and/or locking of the drive wheels.

1. Depress the clutch.
2. Set selector lever to neutral.
3. Move out of the flow of traffic as quickly as possible without impeding other vehicles.
4. Switch off the ignition.

⚠ Warning

When the engine is off, considerably more force is needed to brake and steer.

During an Autostop, the brake servo unit will still be operational.

Do not remove key until vehicle is stationary, otherwise the steering wheel lock could engage unexpectedly.

Check oil level before seeking the assistance of a workshop ⇨ 140.

Low fuel

 illuminates or flashes yellow.

Illuminates

Level in fuel tank is too low.

Flashes

Fuel used up. Refuel immediately. Never run the fuel tank dry.

Refuelling ⇨ 132.

Catalytic converter ⇨ 115.

Immobiliser

 flashes yellow.

Fault in the immobiliser system. The engine cannot be started.

Reduced engine power

 illuminates yellow.

The engine power is limited. Consult a workshop.

Exterior light

 illuminates green.

The exterior lights are on ⇨ 93.

High beam

 illuminates blue.

Illuminated when high beam is on or during headlight flash ⇨ 93.

Fog light

 illuminates green.

The front fog lights are on ⇨ 95.

Rear fog light

 illuminates yellow.

The rear fog light is on ⇨ 95.

Cruise control

 illuminates white or green.

Illuminates white



The system is on.

Illuminates green

Cruise control is active.

Cruise control ⇨ 124.

Speed limiter

 illuminates in the Driver Information Centre when Speed limiter is active. Set speed is indicated alongside  symbol.

Speed limiter ⇨ 125.

Bonnet open

 illuminates yellow.

Illuminates when the bonnet is open.

Stop-start system ⇨ 111.

Door open

 illuminates.

A door or the tailgate is open.

Information displays

Driver Information Centre

The Driver Information Centre is located in the instrument cluster.

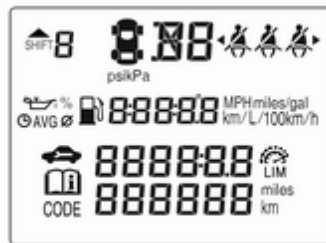





Some of the displayed functions differ when the vehicle is being driven or at a standstill. Some functions are only available when the vehicle is being driven.

Main menus are:

- trip/fuel information, see description below
- vehicle information, see description below

The following indications appear when appropriate:

- warning codes  83
- gear shift indication  74
- tyre pressure warning  157
- seat belt reminder indication  72
- service information  73

Selecting menus and functions

The menus and functions can be selected via the buttons on the turn signal lever.



Press **MENU** to switch between the main menus or to return from a submenu to the next higher menu level.



Turn the adjuster wheel to select a submenu of the main menu or to set a numeric value.



Press **SET/CLR** to select a function or to confirm a message.

Vehicle and service messages are popped-up in the Driver Information Centre if required. Confirm messages by pressing **SET/CLR**. Vehicle messages ⇨ 83.

Trip/Fuel information

Possible pages are:

Trip odometer



Trip odometer displays the current distance since a certain reset.

Trip odometer counts up to 9999.9 km and then restarts at 0.

To reset, press **SET/CLR** for a few seconds.

Fuel range

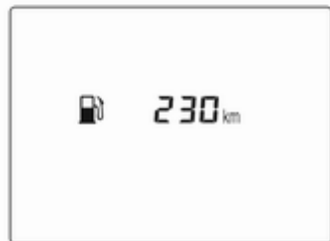



Range is calculated from current fuel tank level and current consumption. The display shows average values.

After refuelling, the range is updated automatically after a brief delay.

When the fuel level in the tank is low, a message appears on the display and control indicator  in the fuel gauge illuminates.

When the tank must be refuelled immediately, a warning code appears and remains on the display.

Additionally, control indicator  flashes in the fuel gauge  76.

Fuel range, LPG version

Display of the approximate total fuel range for both fuel tanks (LPG and petrol).

Average vehicle speed

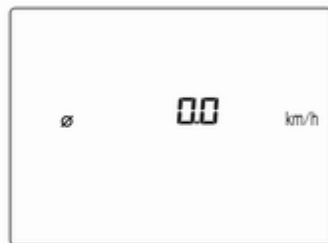

Display of average speed. The measurement can be reset at any time.

To reset, press **SET/CLR** for a few seconds while viewing this page.

Instantaneous fuel economy

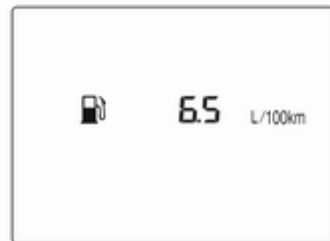

Display of the instantaneous consumption.

On vehicles with LPG engines: Instantaneous consumption is indicated for the currently selected mode, LPG or petrol.

Average fuel economy



Display of average consumption. The measurement can be reset at any time and starts with a default value.

To reset, press **SET/CLR** for a few seconds while viewing this page.

On vehicles with LPG engines:
Average consumption is indicated for the currently selected mode, LPG or petrol.

Timer



Indicates driving time since last reset.

To stop or start timer press **SET/CLR**.

To reset press and hold **SET/CLR** for a few seconds.

Vehicle information

Possible pages are:

- unit
- remaining engine oil life indication
- tyre pressure
- tyre loading

Unit

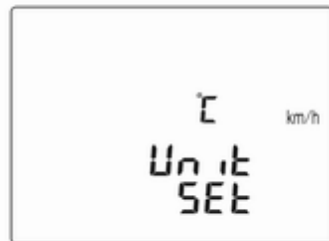

Press **SET/CLR** while page is displayed. Select metric (unit 1) or imperial (unit 2) by turning the adjuster wheel. Press **SET/CLR** to set the unit of measurement.

Remaining oil life



Indicates an estimate of the oil's useful life. The number in percentage means the current remaining oil life and indicates when to change the engine oil and filter ↻ 68.

Tyre pressure

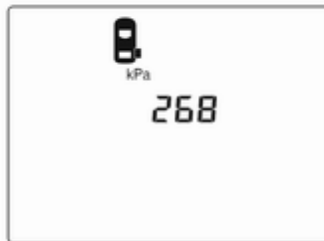

Tyre pressures of all wheels are displayed on this page during driving ↻ 157.

Tyre learn



This display allows for matching new tire and wheel by the tyre pressure monitoring system sensors ↻ 157.

Tyre load

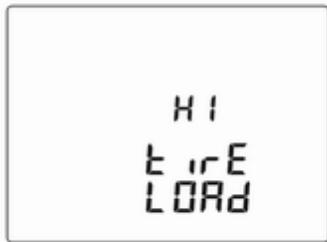

The tyre pressure category according to the actual tyre inflation pressure can be selected ↻ 157.

Outside temperature

Display of current outside temperature.

Language

Select preferred country language as display language.

Time

Display of current time.

Info display

The Info-Display is located in the instrument panel near the instrument cluster.

Depending on the vehicle configuration the vehicle has a

- **Graphic-Info-Display**
- or
- **7" Colour-Info-Display** with touch-screen functionality

The vehicle has a **7" Colour-Info-Display** with touch-screen functionality.

The Info displays can indicate:

- time ↻ 63
- outside temperature ↻ 63
- date ↻ 63
- Infotainment system, see description in the Infotainment manual
- indication of parking assist instructions ↻ 127
- system messages
- settings for vehicle personalisation ↻ 86

Graphic-Info-Display



Press **⏻** to switch on the display.

Press **MENU** to select main menu page.

Turn **MENU** to select a menu page.

Press **MENU** to confirm a selection.

Press **BACK** to exit a menu without changing a setting.

7" Colour-Info-Display

Selecting menus and settings

Menus and settings are accessed via the display.



Press  to switch on the display.

Press  to display the homepage.

Tap required menu display icon with the finger.

Tap a respective icon to confirm a selection.

Tap  to return to the next higher menu level.

Press  to return to the homepage.

For further information, see Infotainment manual.

Vehicle personalisation ⇨ 86.

Valet mode

Some functions of the Driver Information Centre and the Info-Display can be limited for some drivers.

Activation or deactivation of valet mode can be set in the menu **Settings** in the vehicle personalisation menu.

Vehicle personalisation ⇨ 86.

For more information see Infotainment manual.

Vehicle messages

Messages are indicated mainly in the Driver Information Centre, in some cases together with a warning and signal buzzer.



Press **SET/CLR**, **MENU** or turn the adjuster wheel to confirm a message.

Vehicle messages in Driver Information Centre



The vehicle messages are displayed as code numbers.

No. Vehicle message

- 3 Engine coolant level low
- 4 Air conditioning off
- 11 Brakes worn
- 12 Vehicle overloaded
- 13 Compressor overheated

No. Vehicle message

- 15 Centre high-mounted brake light failure
- 16 Brake light failure
- 17 Headlight levelling malfunction
- 18 Left low beam failure
- 19 Rear fog light failure
- 20 Right low beam failure
- 21 Left sidelight failure
- 22 Right sidelight failure
- 23 Reversing light failure
- 24 Number plate light failure
- 25 Left front turn signal failure
- 26 Left rear turn signal failure
- 27 Right front turn signal failure
- 28 Right rear turn signal failure
- 35 Replace battery in radio remote control
- 36 ESC Initialising

No. Vehicle message

- 49 Lane departure warning unavailable
- 52 Change timing belt
- 56 Tyre pressure imbalance on front axle
- 57 Tyre pressure imbalance on rear axle
- 59 Open, then close driver window
- 60 Open, then close front passenger window
- 61 Open, then close left rear window
- 62 Open, then close right rear window
- 65 Theft attempted
- 66 Service anti-theft alarm system
- 67 Service steering wheel lock
- 68 Service power steering
- 75 Service air conditioning

No. Vehicle message

77	Service lane departure warning
79	Top up engine oil
81	Service transmission / transmission malfunction Manual transmission automated ↻ 117
82	Change engine oil soon
84	Engine power reduced
89	Service vehicle soon
90	Service brake assist
95	Service airbag
145	Check washer fluid level
151	Press clutch to start
174	Low vehicle battery
258	Parking assist off

Vehicle messages on Colour-Info-Display

Some important messages appear additionally in the Colour-Info-Display. Some messages only pop-up for a few seconds.

Warning chimes**When starting the engine or whilst driving**

Only one warning chime will sound at a time.

The warning chime regarding unfastened seat belts has priority over any other warning chime.

- If seat belt is not fastened.
- If a door or the tailgate is not fully closed when starting off.
- If a certain speed is exceeded with parking brake applied.
- If a programmed speed is exceeded.
- If a warning message appears in the Driver Information Centre or Info-Display.

- If the parking assist detects an object.
- If unintended lane change occurs.
- If a fault in the automatic locking system is detected.

When the vehicle is parked and/or the driver's door is opened

- With exterior lights on.

During an Autostop

- If the driver's door is opened.

Battery voltage

When the vehicle battery voltage is running low, the warning code 174 will appear in the Driver Information Centre.

1. Switch off immediately any electrical consumers which are not required for a safe drive, e.g.

seat heating, heated windscreen and heated rear window or other main consumers.

2. Charge the vehicle battery by driving continuously for a while or by using a charging device.

The warning code will disappear after the engine has been started twice consecutively without a voltage drop.

If the vehicle battery cannot be recharged, have the cause of the fault remedied by a workshop.

Vehicle personalisation

The vehicle's behaviour can be personalised by changing the settings in the Info-Display.

Some of the personal settings for different drivers can be memorised individually for each vehicle key. Memorised settings ⇨ 23.

Depending on vehicle equipment and country-specific regulations some of the functions described below may not be available.

Some functions are only displayed or active when the engine is running.

Personal settings

Graphic-Info-Display

Press **MENU**, when ignition is on and infotainment system is activated.

Turn the **MENU** button to scroll through the menu list. Press **MENU** to select the respective menu. To close a menu or to go back to previous page, press **BACK**.

Select **Settings**, scroll through the list and select **Vehicle Settings**



In the corresponding submenus the following settings can be changed:

Vehicle Settings

- **Park Assist / Collision Detection**

Park Assist: Activates or deactivates the ultrasonic parking assist.

- **Comfort Settings**

Chime Volume: Changes the volume of warning chimes.

Personalisation by Driver: Activates or deactivates the personalisation function.

Rear Auto Wipe in Reverse: Activates or deactivates

automatic switching on of the rear window wiper when reverse gear is engaged.

- **Languages:** Scroll through the list and select the desired language.

- **Lighting**

Exterior lighting by unlocking:

Activates or deactivates the entry lighting.

Exit Lighting: Activates or deactivates exit lighting and changes lighting duration.

- **Power Door Locks**

Stop door lock if door open:

Activates or deactivates the door locking function while a door is open.

Delayed Door Lock: Activates or deactivates the delayed door locking function. This feature delays the actual locking of the doors until all doors are closed.

- **Remote Lock, Unlock, and Start**

Remote Unlock Feedback:

Activates or deactivates the hazard warning flasher feedback whilst unlocking.

Remote Lock Feedback:

Changes what kind of feedback is given when locking the vehicle.

Remote Door Unlock: Changes the configuration to unlock only the driver's door or the whole vehicle whilst unlocking.

Auto Relock Doors: Activates or deactivates the automatic relock function after unlocking without opening the vehicle.

- **Restore Factory Settings:**

Resets all settings to the default settings.

- **Valet Mode:**

Activated, all vehicle displays are locked and no changes may be performed within the system.

See Infotainment manual.

Personal settings

7" Colour-Info-Display

Press , select **Settings** and then **Vehicle** on the touch-screen.



In the corresponding submenus the following settings can be changed:

Settings

- **Climate & Air Quality**

Auto Fan Max Speed: Modifies the level of the cabin airflow of the climate control in automatic mode.

Air Conditioning Mode: Controls the state of the cooling compressor when the vehicle is started. Last setting (recommended) or at vehicle start is either always on or always off.

Auto Defog: Supports windscreen dehumidification by automatically selecting the necessary settings and automatic air conditioning mode.

Auto Rear Defog: Automatically activates heated rear window.

- **Collision / Detection Systems**

Park Assist: Activates or deactivates the ultrasonic parking assist.

- **Comfort and Convenience**

Chime Volume: Changes the volume of warning chimes.

Personalization By Driver: Activates or deactivates the personalisation function.

Auto Wipe in Reverse Gear: Activates or deactivates automatic switching on of the rear window wiper when reverse gear is engaged.

- **Lighting**

Exit Lighting: Activates or deactivates and changes the duration of exit lighting.

- **Power Door Locks**

Unlocked Door Anti Lock Out:

Activates or deactivates the door locking function while a door is open.

Delayed Door Lock: Activates or deactivates the delayed door locking function. This feature delays the actual locking of the doors until all doors are closed.

- **Remote Lock, Unlock, Start**

Remote Unlock Light Feedback:

Activates or deactivates the hazard warning flasher feedback whilst unlocking.

Remote Door Unlock: Changes the configuration to unlock only the driver's door or the whole vehicle whilst unlocking.

Relock Remotely Unlocked

Doors: Activates or deactivates the automatic relock function after unlocking without opening the vehicle.

Telematics service

OnStar

OnStar is a personal connectivity and service assistant with integrated Wi-Fi hotspot. The OnStar service is available 24 hours a day, seven days a week.

Note

OnStar is not available for all markets. For further information, contact your workshop.

Note

In order to be available and operational, OnStar needs a valid OnStar subscription, functioning vehicle electrics, mobile service and GPS satellite link.

To activate the OnStar services and set up an account, press  and speak with an advisor.

Depending on the equipment of the vehicle, the following services are available:

- Emergency services and support in the case of a vehicle breakdown
- Wi-Fi hotspot
- Smartphone application
- Remote control, e.g. location of the vehicle, activation of horn and lights, control of central locking system
- Stolen vehicle assistance
- Vehicle diagnostics
- Destination download

Note

The OnStar module of the vehicle is deactivated after ten days without an ignition cycle. Functions requiring a data connection will be available again after switching on the ignition.

OnStar buttons

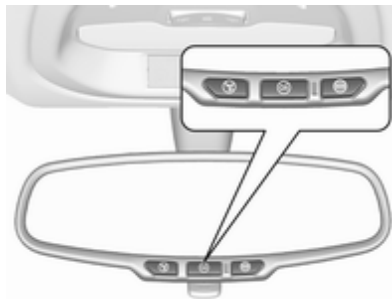

Privacy button

Press and hold  until a message is heard to activate or deactivate the transmission of the vehicle location.

Press  to answer a call or to end a call to an advisor.

Press  to access the Wi-Fi settings.

Service button

Press  to establish a connection to an advisor.

SOS button

Press  to establish a priority emergency connection to a specially trained emergency advisor.

Status LED

Green: The system is ready with activated transmission of the vehicle location.

Green flashing: The system is on a call.

Red: A problem arose.

Off: The system is ready with deactivated transmission of the vehicle location or the system is in standby mode.

Red / green flashing for a short period of time: The transmission of the vehicle location has been deactivated.

OnStar services

General services

If you need any information e.g. opening hours, points of interest and destinations or if you need any support e.g. in the case of a vehicle

breakdown, a flat tyre and empty fuel tank, press  to establish a connection to an advisor.

Emergency services

In the case of an emergency situation, press  and talk to an advisor. The advisor then contacts emergency or assistance service providers and directs them to your vehicle.

In the case of an accident with activation of airbags or belt tensioners, an automatic emergency call is established. The advisor is immediately connected to your vehicle to see whether help is needed.

Wi-Fi hotspot

The Wi-Fi hotspot of the vehicle provides internet connectivity with a maximum speed of 4G/LTE.

Note

The Wi-Fi hotspot functionality is not available for all markets.

Up to seven devices may be connected.

To connect a mobile device with the Wi-Fi hotspot:

1. Press  and then select Wi-Fi settings on the Info-Display. The settings displayed include the Wi-Fi hotspot name (SSID), password and connection type.
2. Start a Wi-Fi network search on your mobile device.
3. Select your vehicle hotspot (SSID) when listed.
4. When prompted, enter the password on your mobile device.

Note

To change the SSID or password, press  and talk to an advisor or log in to your account.

To switch off the Wi-Fi hotspot functionality, press  to call an advisor.

Smartphone app

With the myOpel smartphone app, some vehicle functions can be operated remotely.

The following functions are available:

- Lock or unlock vehicle.
- Honk horn or flash lights.
- Check fuel level, engine oil life and tyre pressure (only with tyre pressure monitoring system).
- Send navigation destination to the vehicle, if equipped with a built-in navigation system.
- Locate vehicle on a map.
- Manage Wi-Fi settings.

To operate these functions, download the app from App Store® or Google Play™ Store.

Remote control

If desired, use any phone to call an advisor, who can remotely operate specific vehicle functions. Find the respective OnStar phone number on our country-specific website.

The following functions are available:

- Lock or unlock vehicle.
- Provide information on the vehicle location.
- Honk horn or flash lights.

Stolen vehicle assistance

If the vehicle is stolen, report the theft to the authorities and request OnStar stolen vehicle assistance. Use any phone to call an advisor. Find the respective OnStar phone number on our country-specific website.

OnStar can provide support in locating and recovering the vehicle.

Theft alert

When the anti-theft alarm system is triggered, a notification is sent to OnStar. You are then informed about this event by text message or email.

Restart prevention

By sending remote signals, OnStar can prevent the vehicle from restarting once it has been turned off.

On-demand diagnostics

At any time e.g. if the vehicle displays a vehicle message, press **Ⓜ** to contact an advisor and ask to complete a real-time diagnostic check to directly determine the issue. Depending on the results, the advisor will provide further support.

Diagnostic report

The vehicle automatically transmits diagnostic data to OnStar which sends a monthly email report to you and your preferred workshop.

Note

The workshop notification function can be disabled in your account.

The report contains the status of key operating systems of the vehicle like engine, transmission, airbags, ABS, and other major systems. It also provides information on possible maintenance items and tyre pressure (only with tyre pressure monitoring system).

To look at the information in greater detail, select the link within the email and log in to your account.

Destination download

A desired destination can be directly downloaded to the navigation system.

Press **Ⓜ** to call an advisor and describe the destination or point of interest.

The advisor can look up any address or point of interest and directly send the destination to the built-in navigation system.

OnStar settings**OnStar PIN**

To have full access to all OnStar services, a four-digit PIN is required. The PIN has to be personalised when first talking to an advisor.

To change the PIN, press **Ⓜ** to call an advisor.

Account data

An OnStar subscriber has an account where all the data is stored. To request a change of the account information, press **Ⓜ** and talk to an advisor or log in to your account.

If the OnStar service is used on another vehicle, press **Ⓜ** and request that the account be transferred to the new vehicle.

Note

In any case, if the vehicle is disposed of, sold or otherwise transferred, immediately inform OnStar about the changes and terminate the OnStar service on this vehicle.

Vehicle location

The vehicle location is transmitted to OnStar when service is requested or triggered. A message on the Info-Display informs about this transmission.

To activate or deactivate the transmission of the vehicle location, press and hold  until an audio message is heard.

The deactivation is indicated by the status light flashing red and green for a short period of time and each time the vehicle is started.

Note

If the transmission of the vehicle location is deactivated, some services are no longer available.

Note

The vehicle location always remains accessible to OnStar in the case of an emergency.

Find the privacy policy in your account.

Software updates

OnStar may remotely carry out software updates without further notice or consent. These updates are to enhance or maintain safety and security or the operation of the vehicle.

These updates may concern privacy issues. Find the privacy policy in your account.

Lighting

Exterior lighting	93
Light switch	93
High beam	93
Headlight flash	93
Headlight range adjustment	94
Headlights when driving abroad	94
Daytime running lights	94
Cornering lights	94
Hazard warning flashers	94
Turn and lane-change signals ...	95
Front fog lights	95
Rear fog light	95
Parking lights	96
Reversing lights	96
Misted light covers	96
Interior lighting	96
Instrument panel illumination control	96
Interior lights	97
Reading lights	97
Lighting features	97
Exit lighting	97
Battery discharge protection	98

Exterior lighting

Light switch



Turn light switch:

- 0** : lights off
- ↔** : sidelights
- ≡D** : headlights

Control indicator **↔** **↔** **↔** 76.

Tail lights

Tail lights are illuminated together with headlights and sidelights.

High beam



To switch from low to high beam, push lever.

To switch to low beam, push lever again or pull.

Headlight flash

To activate the headlight flash, pull lever.

Headlight range adjustment

Manual headlight range adjustment



To adapt headlight range to the vehicle load to prevent dazzling: turn thumb wheel  to required position.

- 0 : front seats occupied
- 1 : all seats occupied
- 2 : all seats occupied and load compartment laden
- 3 : driver's seat occupied and load compartment laden

Headlights when driving abroad

Headlight aim has been preset and should need no further adjustment. When driving in countries with opposite hand traffic, it is not necessary to adjust the headlights.

Daytime running lights

Daytime running light increases visibility of the vehicle during daylight. They are switched on automatically when ignition is on.

Cornering lights



On tight bends or when turning off, depending on the steering angle or the indicator light signal, an additional left or right reflector is switched on

which illuminates the road in the direction of travel. It is activated up to a speed of 40 km/h.

Hazard warning flashers



Operated by pressing .

In the event of an accident with airbag deployment, the hazard warning flashers are activated automatically.

Turn and lane-change signals



lever up : right turn signal
 lever down : left turn signal

A resistance point can be felt when moving the lever.

Constant flashing is activated when the lever is being moved beyond the resistance point. It is deactivated when the steering wheel or lever is moved in the opposite direction or lever is manually moved back to its neutral position.

Activate temporary flashing by holding the lever just before the resistance point. Turning lights will flash until lever is being released.

To activate three flashes, tap the lever briefly without passing the resistance point.

Front fog lights



Operated by pressing #D.

Rear fog light



Operated by pressing 0#.

Light switch in position >E: Rear fog light can only be switched on with front fog lights.

Parking lights



When the vehicle is parked, the parking lights on one side can be activated:

1. Switch off the ignition.
2. Move the turn signal lever all the way up (right parking lights) or down (left parking lights).

Confirmed by an acoustic signal and the corresponding turn signal control indicator.

Reversing lights

The reversing light comes on when the ignition is on and reverse gear is selected.

Misted light covers

The inside of the light housing may mist up briefly in poor, wet and cold weather conditions, in heavy rain or after washing. The mist disappears quickly by itself; to help switch on the headlights.

Interior lighting

Instrument panel illumination control



Brightness of the following lights can be adjusted when the exterior lights are on:

- instrument panel illumination
- Info-Display
- illuminated switches and operation elements

Turn thumb wheel  and hold until the desired brightness is obtained.

Interior lights

When opening a door, the courtesy light automatically switches on and then off after a delay.

When exterior lighting has been on, courtesy light will turn on when ignition is switched off.

Note



In the event of an accident with airbag deployment, the courtesy lights are turned on automatically.

Courtesy light



Operate rocker switch:

centre position  : automatic switching on when opening a door.
Turns off after a delay.

press  : permanently on
press  : permanently off

Reading lights



Operated by pressing the buttons in front.

Lighting features

Exit lighting

Path lighting

Headlights, tail lights and number plate lights illuminate the surrounding area for an adjustable time after leaving the vehicle.

Activating



1. Switch off the ignition.
2. Remove the ignition key.
3. Open driver's door.

4. Pull the turn signal lever.
5. Close the driver's door.

If the driver's door is not closed the lights switch off after two minutes.

Exit lighting is switched off immediately if the turn signal lever is pulled while the driver's door is open.

Activation, deactivation and duration of this function can be changed in the Info-Display. Vehicle personalisation ⇨ 86.

The settings can be saved for the key being used ⇨ 23.

Battery discharge protection

Switching off electric lights

To prevent discharge of the vehicle battery when the ignition is switched off, some interior lights are switched off automatically after some time.

Climate control

Climate control systems	99
Heating and ventilation system .	99
Air conditioning system	100
Electronic climate control system	102
Air vents	105
Adjustable air vents	105
Fixed air vents	106
Maintenance	106
Air intake	106
Pollen filter	106
Air conditioning regular operation	106
Service	107

Climate control systems

Heating and ventilation system



Controls for:

- temperature
- fan speed
- air distribution

 : air recirculation

 : heated rear window

Heated rear window  ↗ 32.

Heated exterior mirrors  ↗ 29.

Heated seats  ↗ 38.

Heated steering wheel  ↗ 61.

Temperature

Adjust the temperature by turning the temperature control.

red : warm

blue : cold

Heating will not be fully effective until the engine has reached normal operating temperature.

Fan speed

Adjust the air flow by switching the fan to the desired speed.

Air distribution

 : to head area via adjustable air vents

 : to head area and foot well



 : to foot well, with a small amount of air being directed to windscreen and front door windows

 : to windscreen and foot well, with a small amount of air being directed to front door windows

 : to windscreen and front door windows

Intermediate settings are possible.

Demisting and defrosting the windows

- Set air distribution control to .
- Set temperature control to warmest level.
- Set fan speed to highest speed.
- Switch on heated rear window .
- Open side air vents as required and direct them towards door windows.
- For simultaneous warming of the foot well, set air distribution control to .

Air conditioning system



Controls for:

- temperature
- fan speed
- air distribution

A/C : cooling

 : air recirculation

 : heated rear window

Heated rear window  ⇨ 32.

Heated exterior mirrors  ⇨ 29.

Heated seats  ⇨ 38.

Heated steering wheel  ⇨ 61.

Temperature

Adjust the temperature by turning the temperature control.

red : warm

blue : cold

Heating will not be fully effective until the engine has reached normal operating temperature.

Fan speed



Adjust the air flow by switching the fan to the desired speed.

Air distribution

 : to head area via adjustable air vents

 : to head area and foot well

 : to foot well, with a small amount of air being directed to windscreen and front door windows

-  : to windscreen and foot well, with a small amount of air being directed to front door windows
-  : to windscreen and front door windows (air conditioning is activated in the background to help preventing windows from fogging)

Intermediate settings are possible.

Cooling A/C

Press **A/C** to switch on cooling. The LED in the button illuminates to indicate activation. Cooling is only functional when the engine is running and climate control fan is switched on.

Press **A/C** again to switch off cooling.

The air conditioning system cools and dehumidifies (dries) as soon as the outside temperature is slightly above the freezing point. Therefore condensation may form and drip from under the vehicle.

If no cooling or drying is required, switch off the cooling system for fuel saving reasons.

Activated cooling may inhibit Autostops.

Stop-start system  111.

Air recirculation system

Press  to activate air recirculation mode. The LED in the button illuminates to indicate activation.

Press  again to deactivate air recirculation mode.

Warning

Driving with recirculation mode for a prolonged period of time can make you sleepy. Periodically turn to the outside air mode for fresh air.



The exchange of fresh air is reduced in air recirculation mode. In operation without cooling the air humidity increases, so the windows may mist up. The quality of the passenger compartment air deteriorates, which may cause the vehicle occupants to feel drowsy.

In warm and very humid ambient air conditions, the windscreen may mist up from outside, when cold air is



directed towards it. If windscreen mists up from outside, activate windscreen wiper and deactivate .

Maximum cooling

Briefly open the windows so that hot air can disperse quickly.



- Switch on cooling **A/C**.
- Switch on Air recirculation system .
- Set temperature control to coldest level.
- Set fan speed to highest level.
- Set air distribution control to .
- Open all vents.

Demisting and defrosting the windows

- Set air distribution control to .
- Set temperature control to warmest level.
- Set fan speed to highest level.
- Switch on heated rear window .
- Open side air vents as required and direct them towards the door windows.

If air distribution is set to , A/C operates and air recirculation mode will be set to demisting/defrosting regardless of indicator status.

Note

If  is pressed while the engine is running, an Autostop will be inhibited until  is pressed again.

If  is pressed while the engine is in an Autostop, the engine will restart automatically.



Stop-start system ⇨ 111.

Electronic climate control system



Controls for:

- temperature
- air distribution
- fan speed

- A/C** : cooling
- AUTO** : automatic mode
-  : manual air recirculation
-  : demisting and defrosting
-  : heated rear window

Heated rear window  ⇨ 32.

Heated exterior mirrors  ⇨ 29.

Heated seats  ⇨ 38.

Heated steering wheel  ⇨ 61.

Climate control settings are shown on the Info-Display. Setting modifications are briefly popped-up, superimposed over the currently displayed menu.

The electronic climate control system is only fully operational when the engine is running.

Heating will not be fully effective until the engine has reached normal operating temperature.

Automatic mode AUTO

The system automatically controls the fan speed, air delivery, air conditioning, and recirculation in order to heat or cool the vehicle to the desired temperature.

When the **AUTO** indicator light is on, the system is in full automatic operation.

If the air delivery mode, fan speed, recirculation, or air conditioning setting is adjusted, the **AUTO** indicator turns off.

To improve fuel efficiency and to cool the vehicle faster, recirculation may be automatically selected in warm weather. The recirculation light will not come on. Press  to select recirculation; press it again to select outside air.

To turn off the system, press power .

Basic setting for maximum comfort:

- Press **AUTO**. The LED in the button illuminates to indicate activation.
- Open all air vents to allow optimised air distribution in Automatic mode.
- Set the preselected temperature. Recommended temperature is 22 °C.

Temperature preselection

Set temperature to the desired value. It is indicated on the display in the temperature control.

For reasons of comfort, change temperature only in small increments. If the minimum temperature **Lo** is set, the climate control system runs at maximum cooling, if cooling **A/C** is active.

If the maximum temperature **Hi** is set, the climate control system runs at maximum heating.



Recommended temperature is 22 °C.

Note



If **A/C** is switched on, reducing the set cabin temperature can cause the engine to restart from an Autostop or inhibit an Autostop.

Stop-start system ⇨ 111.

Demisting and defrosting the windows

- Press . The LED in the button illuminates to indicate activation.
- Temperature and air distribution are set automatically and the fan runs at high speed.
- Switch on heated rear window .
- To return to previous mode: press . To return to Automatic mode: press **AUTO**.

Note

If  is pressed while the engine is running, an Autostop will be inhibited until  is pressed again.

If  is pressed while the engine is in an Autostop, the engine will restart automatically.

Stop-start system ⇨ 111.

Air recirculation system

Press  to activate air recirculation mode. The LED in the button illuminates to indicate activation.

Press  again to deactivate air recirculation mode.

Warning

Driving with recirculation mode for a prolonged period of time can make you sleepy. Periodically turn to the outside air mode for fresh air.

The exchange of fresh air is reduced in air recirculation mode. In operation without cooling the air humidity increases, so the windows may mist up. The quality of the passenger compartment air deteriorates, which may cause the vehicle occupants to feel drowsy.

In warm and very humid ambient air conditions, the windscreen may mist up from outside, when cold air is directed towards it. If windscreen mists up from outside, activate windscreen wiper and deactivate .

Manual settings

Climate control system settings can be changed by activating the buttons and rotary knobs as follows. Changing a setting will deactivate Automatic mode.

Fan speed





Adjust the air flow by switching the fan to the desired speed. The selected fan speed is indicated by the number of segments in the display. If the fan is switched off the air conditioning is also deactivated.



To return to Automatic mode: Press **AUTO**.

Air distribution



Press appropriate button for desired adjustment. Activation is indicated by the LED in the button.

-  : to head area
-  : to head area and foot well
-  : to foot well, with a small amount of air being directed to windscreen and front door windows

-  : to windscreen and foot well, with a small amount of air being directed to front door windows
-  : to windscreen and front door windows (air conditioning is activated in the background to help preventing windows from fogging)

To return to Automatic mode: Press **AUTO**.

Cooling A/C

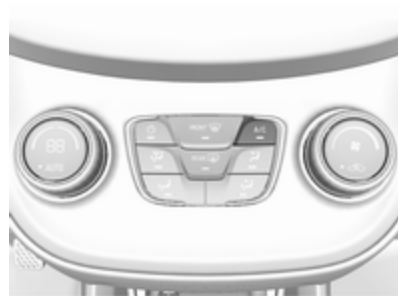

Press **A/C** to switch on cooling. The LED in the button illuminates to indicate activation. Cooling is only functional when the engine is running and climate control fan is switched on.

Press **A/C** again to switch off cooling. The air conditioning system cools and dehumidifies (dries) as soon as the outside temperature is slightly above the freezing point. Therefore condensation may form and drip from under the vehicle.

If no cooling or drying is required, switch off the cooling system for fuel saving reasons.

Activated cooling might inhibit Autostops.

Stop-start system ⇨ 111.

Air recirculation mode

Press  to activate air recirculation mode. The LED in the button illuminates to indicate activation.

Press  again to deactivate air recirculation mode.

Warning



The exchange of fresh air is reduced in air recirculation mode. In operation without cooling, the air humidity increases, so the

windows may mist up from inside. The quality of the passenger compartment air deteriorates, which may cause the vehicle occupants to feel drowsy.

In warm and very humid ambient air conditions, the windscreen may mist up from outside when cold air is directed towards it. If windscreen mists up from outside, activate windscreen wiper.

Maximum cooling

Briefly open the windows so that hot air can disperse quickly.

- Switch on cooling **A/C**.
- Switch on Air recirculation system .
- Set temperature control to coldest level.
- Set fan speed to highest level.
- Set air distribution control to .
- Open all vents.

Air vents

Adjustable air vents

At least one air vent must be open while the cooling is on.



Direct the flow of air by tilting the slats.

Warning

Do not attach any objects to the slats of the air vents. Risk of damage and injury in case of an accident.

Fixed air vents

Additional air vents are located beneath the windscreen and door windows and in the foot wells.

Maintenance

Air intake

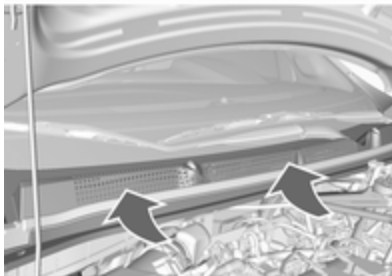

The air intake in front of the windscreen in the engine compartment must be kept clear to allow air intake. Remove any leaves, dirt or snow.

Pollen filter

The pollen filter cleans dust, soot, pollen and spores from the air entering the vehicle through the air intake.

The filter should be replaced as part of routine scheduled maintenance.

Caution

More frequent maintenance of the passenger compartment air filter is required if the driving circumstances are dusty roads, air pollution areas, and frequent unpaved roads.

The filter efficiency is decreased and the bronchus is badly affected.

Air conditioning regular operation

In order to ensure continuously efficient performance, cooling must be operated for a few minutes once a month, irrespective of the weather and time of year. Operation with cooling is not possible when the outside temperature is too low.

Service

For optimal cooling performance, it is recommended to annually check the climate control system, starting three years after initial vehicle registration, including:

- functionality and pressure test
- heating functionality
- leakage check
- check of drive belts
- cleaning of condenser and evaporator drainage
- performance check

Note

Refrigerant R-134a contains fluorinated greenhouse gases.

Driving and operating

Driving hints	108
Control of the vehicle	108
Steering	109
Starting and operating	109
New vehicle running-in	109
Ignition switch positions	109
Retained power off	110
Starting the engine	110
Overrun cut-off	111
Stop-start system	111
Parking	114
Engine exhaust	115
Catalytic converter	115
Manual transmission	115
Manual transmission automated	116
Transmission display	116
Starting the engine	116
Selector lever	117
Manual mode	118
Electronic driving programmes	118
Fault	118

Brakes	119
Antilock brake system	119
Parking brake	120
Brake assist	120
Hill start assist	120
Ride control systems	121
Traction Control system	121
Electronic Stability Control	122
City mode	123
Driver assistance systems	124
Cruise control	124
Speed limiter	125
Parking assist	127
Lane departure warning	128
Fuel	129
Fuel for petrol engines	129
Fuel for liquid gas operation	130
Refuelling	132
Fuel consumption - CO ₂ -Emissions	136

Driving hints

Control of the vehicle

Never coast with engine not running

Many systems will not function in this situation (e.g. brake servo unit, power steering). Driving in this manner is a danger to yourself and others.

All systems function during an Autostop.

Stop-start system ⇨ 111.

Idle boost

If charging of the vehicle battery is required due to battery condition, the power output of the generator must be increased. This will be achieved by an idle boost which may be audible.

A message appears in the Driver Information Centre.

Pedals

To ensure the pedal travel is uninhibited, there must be no mats in the area of the pedals.

Use only floor mats, which fit properly and are fixed by the retainers on the driver side.

Driving downhill

Engage a gear when driving downhill to ensure that sufficient brake pressure is available.

Steering

If power steering assist is lost because the engine stops or due to a system malfunction, the vehicle can be steered but may require increased effort.

Control indicator ☹! ⇨ 74.

Caution

Vehicle equipped with electric power steering:

If the steering wheel is turned until it reaches the end of its travel and is held against that position for an extended period of time, power steering assistance may be reduced.

If the steering assistance is used for an extended period of time, power assistance may be reduced.

Power steering assistance should return back to normal when the system has cooled down.

Starting and operating

New vehicle running-in

Do not brake unnecessarily hard for the first few journeys.

During the first drive, smoke may occur because of wax and oil evaporating off the exhaust system. Park the vehicle in the open for a while after the first drive and avoid inhaling the fumes.

During the running-in period, fuel and engine oil consumption may be higher.

Autostop may be inhibited to allow for charging of the vehicle battery.

Ignition switch positions

Turn key:

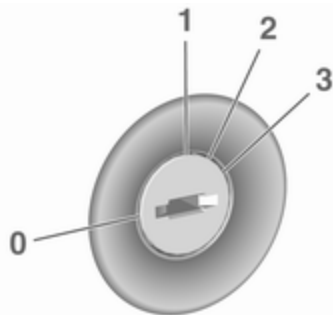

- 0** : ignition off: Some functions remain active until key is removed or driver's door is opened, provided the ignition was on previously
- 1** : accessory power mode: Steering wheel lock released, some electrical functions are operable, ignition is off
- 2** : ignition on power mode: Ignition is on. Control indicators illuminate and most electrical functions are operable
- 3** : engine start: Release key after starting procedure begins

Steering wheel lock

Remove key from ignition switch and turn steering wheel until it engages.

Retained power off

The following electronic systems are operable until the driver's door is opened or at the latest for ten minutes after the ignition is switched off:

- power windows
- power outlets
- power sunroof

Power to the Infotainment system will continue to operate for 30 minutes or until the key is removed from the ignition switch, regardless of whether any door is opened.

Starting the engine

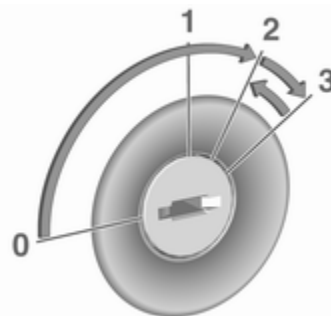

Turn key to position **1** to release the steering wheel lock.

Manual transmission: operate clutch and brake pedal.

Manual transmission automated: operate brake pedal.

Do not operate the accelerator pedal.

Turn key briefly to position **3** and release: an automatic procedure operates the starter after a brief delay, until the engine is running. See "Automatic Starter Control".

Before restarting or to switch off the engine, turn the key back to position **0**.

During an Autostop, the engine can be started by depressing the clutch pedal.

Starting the vehicle at low temperatures

The start of the engine without additional heaters is possible down to -30 °C.

Required is an engine oil with the correct viscosity, the correct fuel, performed services and a sufficiently charged vehicle battery.

Automatic starter control

This function controls the engine starting procedure. The driver does not need to hold the key in position **3**. Once applied, the system will go on starting automatically until the engine is running. Because of the checking procedure, the engine starts running after a short delay.

Possible reasons for a non-starting engine:

- clutch pedal not operated (manual transmission)
- brake pedal not operated (manual transmission automated)
- timeout occurred

Turbo engine warm-up

Upon start-up, engine available torque may be limited for a short time, especially when the engine temperature is cold. The limitation is to allow the lubrication system to fully protect the engine.

Overrun cut-off

The fuel supply is automatically cut off during overrun, i.e. when the vehicle is driven with a gear engaged but accelerator is released.

Depending on driving conditions, the overrun cut-off may be deactivated.

Stop-start system

The stop-start system helps to save fuel and to reduce the exhaust emissions. When conditions allow, it switches off the engine as soon as the vehicle is at a low speed or at a standstill, e.g. at a traffic light or in a traffic jam.

On vehicles with manual transmission, the engine is started automatically as soon as the clutch is depressed.

On vehicles with manual transmission automated, the engine is started automatically as soon as the brake pedal is released.

A vehicle battery sensor ensures that an Autostop is only performed if the vehicle battery is sufficiently charged for a restart.

Activation

The stop-start system is available as soon as the engine is started, the vehicle starts-off and the conditions as stated below in this section are fulfilled.

Deactivation



Deactivate the stop-start system manually by pressing . The deactivation is indicated when the LED in the button extinguishes.

Autostop

Vehicles with manual transmission

If the vehicle is at a low speed or at a standstill, activate an Autostop as follows:

- Depress the clutch pedal.
- Set the lever in neutral.
- Release the clutch pedal.

The engine will be switched off while the ignition stays on.

Vehicles with manual transmission automated

If the vehicle is at a standstill with the brake pedal depressed, Autostop is activated automatically.

The engine will be switched off while the ignition stays on.

The stop-start system will be disabled on inclines of 15% or more.

Indication



An Autostop is indicated by the needle at the **AUTOSTOP** position in the tachometer.

During an Autostop, the heating and brake performance will be maintained.

Conditions for an Autostop

The stop-start system checks if each of the following conditions is fulfilled:

- The stop-start system is not manually deactivated.
- The bonnet is fully closed.
- The driver's door is closed or the driver's seat belt is fastened.
- The vehicle battery is sufficiently charged and in good condition.
- The engine is warmed-up.
- The engine coolant temperature is not too high.
- The engine exhaust temperature is not too high, e.g. after driving with high engine load.
- The ambient temperature is above -5°C .
- The climate control system allows an Autostop.

- The brake vacuum is sufficient.
- The vehicle was driven at least at walking speed since the last Autostop.

Otherwise an Autostop will be inhibited.

Certain settings of the climate control system may inhibit an Autostop. See "Climate control" chapter for further information ↷ 102.

Immediately after motorway driving an Autostop may be inhibited.

New vehicle running-in ↷ 109.

Vehicle battery discharge protection

To ensure reliable engine restarts, several vehicle battery discharge protection features are implemented as part of the stop-start system.

Power saving measures

During an Autostop, several electrical features, e.g., the rear window heating, are disabled or switched into a power saving mode. The fan speed of the climate control system is reduced to save power.

Restart of the engine by the driver

Vehicles with manual transmission

Depress the clutch pedal to restart the engine.

If the selector lever is shifted out of neutral before depressing the clutch pedal first, control indicator  illuminates or is shown as a symbol in the Driver Information Centre.

Control indicator  ↷ 73.

Vehicles with manual transmission automated

Release the brake pedal or move selector lever out of **D** to restart the engine.

Restart of the engine by the stop-start system

The selector lever must be in neutral to enable an automatic restart.

If one of the following conditions occurs during an Autostop, the engine will be restarted automatically by the stop-start system:

- The stop-start system is manually deactivated.
- The bonnet is opened.

- The driver's seat belt is unfastened and the driver's door is opened.
- The engine temperature is too low.
- The charging level of the vehicle battery is below a defined level.
- The brake vacuum is not sufficient.
- The vehicle is driven at least at walking speed.
- The climate control system requests an engine start.
- The air conditioning is manually switched on.

If the bonnet is not fully closed, a warning message is displayed in the Driver Information Centre.

If an electrical accessory, e.g. a portable CD player, is connected to the power outlet, a brief power drop during restart might be noticeable.

Parking

⚠ Warning

- Do not park the vehicle on an easily ignitable surface. The high temperature of the exhaust system could ignite the surface.
- Always apply the parking brake. Activate the manual parking brake without pressing the release button. Apply as firmly as possible on a downhill slope or uphill slope. Depress brake pedal at the same time to reduce operating force.
- Switch off the engine.
- If the vehicle is on a level surface or uphill slope, engage first gear before removing the ignition key. On an uphill slope, turn the front wheels away from the kerb.

If the vehicle is on a downhill slope, engage reverse gear before removing the ignition

key. Turn the front wheels towards the kerb.

- Close the windows and the sunroof.
- Remove the ignition key from the ignition switch. Turn the steering wheel until the steering wheel lock is felt to engage.

For vehicles with manual transmission automated, the key can only be removed from the ignition switch when the parking brake is applied.

- Lock the vehicle.
- Activate the anti-theft alarm system.
- The engine cooling fans may run after the engine has been switched off ⇨ 139.

Caution

After running at high engine speeds or with high engine loads, operate the engine briefly at a low

load or run in neutral for approx. 30 seconds before switching off, in order to protect the turbocharger.

Note

In the event of an accident with airbag deployment, the engine is switched off automatically if the vehicle comes to a standstill within a certain time.

Engine exhaust

⚠ Danger

Engine exhaust gases contain poisonous carbon monoxide, which is colourless and odourless and could be fatal if inhaled.

If exhaust gases enter the interior of the vehicle, open the windows. Have the cause of the fault rectified by a workshop.

Avoid driving with an open load compartment, otherwise exhaust gases could enter the vehicle.

Catalytic converter

The catalytic converter reduces the amount of harmful substances in the exhaust gases.

Caution

Fuel grades other than those listed on pages ↻ 129, ↻ 184 could damage the catalytic converter or electronic components.

Unburnt petrol will overheat and damage the catalytic converter. Therefore avoid excessive use of the starter, running the fuel tank dry and starting the engine by pushing or towing.

In the event of misfiring, uneven engine running, a reduction in engine performance or other unusual problems, have the cause of the fault rectified by a workshop as soon as possible. In an emergency, driving can be continued for a short period, keeping vehicle speed and engine speed low.

Manual transmission

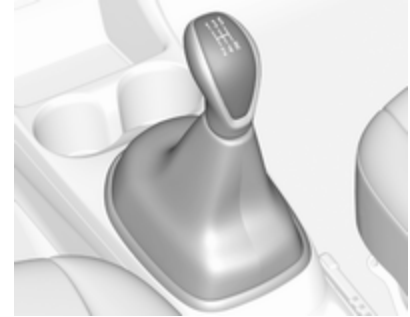

To engage reverse, depress the clutch pedal and engage the reverse gear.

If the gear does not engage, set the lever to neutral, release the clutch pedal and depress again; then repeat gear selection.

Do not slip the clutch unnecessarily.

When operating, depress the clutch pedal completely. Do not use the pedal as a foot rest.

Caution

It is not advisable to drive with the hand resting on the selector lever.

Upshift indication ⇨ 74.

Stop-start system ⇨ 111.

Manual transmission automated

The automated manual transmission permits manual gearshifting (manual mode) or automatic gearshifting (automatic mode), both with automatic clutch control.

Manual shifting is possible by tapping the selector lever in manual mode.

Note

When unlocking or opening a vehicle door, a sound may be audible caused by the hydraulic system.

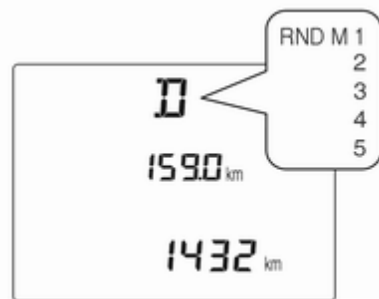
Transmission display

In automatic mode, the driving programme is indicated by **D** in the Driver Information Centre.

In manual mode, **M** and the number of the selected gear is indicated.

R indicates reverse gear.

N indicates neutral.

Starting the engine

To start the engine, depress the brake pedal, if transmission is not in position **N**.

Transmission automatically shifts to **N** upon starting. There may be a slight delay.

Starting is not possible if all brake lights fail.

Selector lever

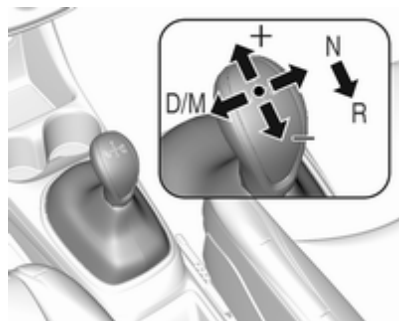

Always move the selector lever in the appropriate direction as far as it will go. Upon release, it automatically returns to the centre position.

Note

Do not hold the selector lever in an intermediate position. Not fully engaging a gear may lead to

malfunction and the error code 81 may be displayed in the Driver Information Centre.

Return the selector lever to the centre position. After a short while **N** will be displayed in the Driver Information Centre and the system will operate normally again.

Vehicle messages ⇨ 83.

- N** : neutral position
- D/M** : switch between automatic (**D**) and manual (**M**) shift mode. The transmission display shows either **D** or **M** with the selected gear
- +** : upshifting in manual mode
- : downshifting in manual mode
- R** : reverse gear. Engage only when vehicle is stationary

If selector lever is moved from **R** to the left, **D** is directly engaged.

If selector lever is moved from **D** to **+** or **-**, manual mode **M** is selected and the transmission shifts.

Starting off

Depress the brake pedal and move the selector lever to **D/M** or **R**. If **D** is selected, transmission is in automatic mode and first gear is engaged. If **R** is selected, reverse gear is engaged. The vehicle starts to move when the brake pedal is released.

To start off immediately without depressing the brake pedal, move the selector lever to **D** or **R**. **D** or **R** will flash for a short time in the Driver Information Centre. Accelerate as long as **D** or **R** flashes. The selected gear is engaged and the vehicle starts moving.

If the accelerator pedal is not depressed as long as **D** or **R** are flashing in the Driver Information Centre, no gear is engaged.

Stopping the vehicle

In **D**, first gear is engaged and the clutch is released when the vehicle is stopped. In **R**, reverse gear remains engaged.

Engine braking

Automatic mode

When driving downhill, the manual transmission automated does not shift into higher gears until a fairly high engine speed has been reached. It shifts down in good time when braking.

Manual mode

To utilise the engine braking effect, select a lower gear in good time when driving downhill. Changing into manual mode is only possible while the engine is running.

Rocking the vehicle

Rocking the vehicle is only permissible if the vehicle is stuck in sand, mud or snow. Move the selector lever between **R** and **D** in a repeat pattern. Do not race the engine and avoid sudden acceleration.

Parking

The most recently engaged gear (see transmission display) remains engaged when switching off ignition. With **N**, no gear is engaged.

Therefore always apply the parking brake when switching off ignition. If parking brake is not applied, **P** flashes in the transmission display and the key cannot be removed from the ignition switch. **P** stops flashing in the transmission display as soon as the parking brake is slightly applied.

When the ignition is switched off, the transmission no longer responds to movement of the selector lever.

Manual mode

If a higher gear is selected when the engine speed is too low, or a lower gear when the speed is too high, the shift is not executed. This prevents the engine from running at too low or too high an engine speed. **M** and the number of the selected gear will be flashed, then the current gear is displayed again..

If engine speed is too low, the transmission automatically shifts to a lower gear.

When **+** or **-** is selected in automatic mode, the transmission switches to manual mode and shifts accordingly.

Gear shift indication

The symbol ▲ with a number alongside it, is indicated when gearshifting is recommended for fuel saving reasons.

Shift indication appears only in manual mode.

Electronic driving programmes

The adaptive programme tailors gearshifting to the driving conditions, e.g. greater load or gradients.

Fault

To prevent damage to the manual transmission automated, the clutch is engaged automatically at high clutch temperatures.

In the event of a fault, control indicator  illuminates. Additionally, a warning message is displayed in the Driver Information Centre. Vehicle messages ⇨ 83.

Continued driving is restricted or not possible, depending on the fault.

Have the cause of the fault remedied by a workshop.

Brakes

The brake system comprises two independent brake circuits.

If a brake circuit fails, the vehicle can still be braked using the other brake circuit. However, braking effect is achieved only when the brake pedal is depressed firmly. Considerably more force is needed for this. The braking distance is extended. Seek the assistance of a workshop before continuing the journey.

When the engine is not running, the support of the brake servo unit disappears once the brake pedal has been depressed once or twice.

Braking effect is not reduced, but braking requires significantly greater force. It is especially important to bear this in mind when being towed.

Control indicator  ↗ 73.

Antilock brake system

Antilock brake system (ABS) prevents the wheels from locking.

ABS starts to regulate brake pressure as soon as a wheel shows a tendency to lock. The vehicle remains steerable, even during hard braking.

ABS control is made apparent through a pulse in the brake pedal and the noise of the regulation process.

For optimum braking, keep the brake pedal fully depressed throughout the braking process, despite the fact that the pedal is pulsating. Do not reduce the pressure on the pedal.

After starting-off the system performs a self-test which may be audible.

Control indicator  ↗ 74.

Adaptive brake light

During full braking, all three brake lights flash for the duration of ABS control.

Fault**⚠ Warning**

If there is a fault in the ABS, the wheels may be liable to lock due to braking that is heavier than normal. The advantages of ABS are no longer available. During hard braking, the vehicle can no longer be steered and may swerve.

Have the cause of the fault remedied by a workshop.

Parking brake**Manual parking brake****⚠ Warning**

Always apply parking brake firmly without operating the release button, and apply as firmly as possible on a downhill or uphill slope.

To release the parking brake, pull the lever up slightly, press the release button and fully lower the lever.

To reduce the operating forces of the parking brake, depress the brake pedal at the same time.

Control indicator (D) ⇨ 73.

Brake assist

If the brake pedal is depressed quickly and forcefully, maximum brake force is automatically applied (full braking).

Maintain steady pressure on the brake pedal for as long as full braking is required. Maximum brake force is automatically reduced when the brake pedal is released.

Hill start assist

The system helps prevent unintended movement when driving away on inclines.

When releasing the brake pedal after stopping on an incline, the brakes remain on for a further two seconds. The brakes release automatically as

soon as the vehicle begins to accelerate or the two seconds holding time is over.

The hill start assist is only active when the engine is running.

Ride control systems

Traction Control system

The Traction Control system (TC) is a component of the Electronic Stability Control (ESC).

TC improves driving stability when necessary, regardless of the type of road surface or tyre grip, by preventing the drive wheels from spinning.

As soon as the drive wheels start to spin, engine output is reduced and the wheel spinning the most is braked individually. This considerably improves the driving stability of the vehicle on slippery road surfaces.



TC is operational after each engine start as soon as the control indicator  extinguishes.

When TC operates  flashes.

Warning

Do not let this special safety feature tempt you into taking risks when driving.

Adapt speed to the road conditions.

Deactivation



TC can be switched off when spinning of drive wheels is required: press  briefly.



Control indicator  illuminates.

When TC is deactivated, ESC remains active.

TC is reactivated by pressing  again.

TC is also reactivated the next time the ignition is switched on.

Fault

If there is a fault in the system the control indicator  illuminates continuously and a warning code appears in the Driver Information Centre. The system is not operational.

Have the cause of the fault remedied by a workshop.

Electronic Stability Control

Electronic Stability Control (ESC) improves driving stability when necessary, regardless of the type of road surface or tyre grip.

As soon as the vehicle starts to swerve (understeer/oversteer), engine output is reduced and the wheels are braked individually.

ESC operates in combination with the Traction Control system (TC). It prevents the drive wheels from spinning.



ESC is operational after each engine start as soon as the control indicator  extinguishes.

When ESC operates  flashes.

Warning

Do not let this special safety feature tempt you into taking risks when driving.



Adapt speed to the road conditions.



Control indicator   74.

Deactivation



For very high-performance driving ESC can be deactivated:

Press and hold  for a minimum of five seconds. Control indicator  illuminates.

ESC is reactivated by pressing  again. If the TC system was previously disabled, both TC and ESC are reactivated.  and  extinguish when TC and ESC are reactivated.

ESC is also reactivated the next time the ignition is switched on.

Fault

If there is a fault in the system, the control indicator  illuminates continuously and a warning code appears in the Driver Information Centre. The system is not operational.

Have the cause of the fault remedied by a workshop.

City mode

City mode is a feature which enables increased steering assistance during lower speed conditions, e.g. city traffic or parking. Steering assistance is increased for greater convenience.

Activation



Press  when engine is running. The system works from standstill up to 60 km/h, and also in reverse gear. Above this speed, the system changes to normal mode. When activated, City mode engages automatically below 60 km/h.

An illuminated LED in the City mode button indicates that the system is active and a message pops-up in the Driver Information Centre.

City mode remains active during an Autostop, but is only operational when the engine is running.

Stop-start system  111.

Deactivation

Press . The LED in the button extinguishes.

Each time the engine is started, City mode is deactivated.

Overload

If the steering in City mode is heavily loaded, e.g. in long parking manoeuvres or heavy city traffic, the system is deactivated for overheat protection. Steering operates in normal mode until City mode activates automatically

Fault

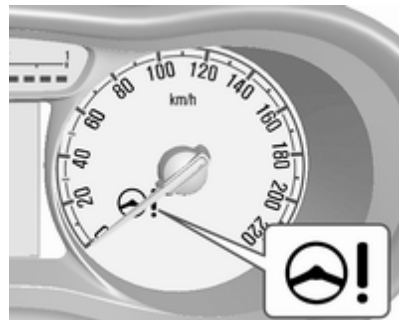

In the event of a fault in the system, control indicator  illuminates.

Vehicle messages  83.

Driver assistance systems

Warning

Driver assistance systems are developed to support the driver and not to replace the driver's attention.

The driver accepts full responsibility when driving the vehicle.

When using driver assistance systems, always take care regarding the current traffic situation.

Cruise control

The cruise control can store and maintain speeds of approx. 25 km/h to 170 km/h. Deviations from the stored speeds may occur when driving uphill or downhill.

For safety reasons, the cruise control cannot be activated until the brake pedal has been operated once. Activating in first gear is not possible.

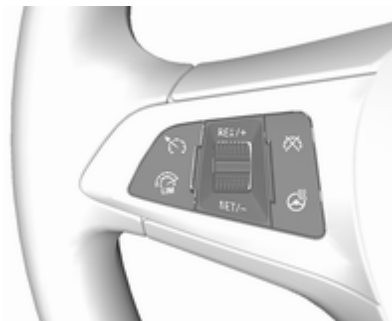



Do not use the cruise control if it is not advisable to maintain a constant speed.

On vehicles with manual transmission automated, cruise control can be activated in automatic mode and manual mode.

Control indicator   76.

Switching on



Press ; control indicator  in instrument cluster illuminates white.

Activation

Accelerate to the desired speed and turn thumb wheel to **SET/-**, the current speed is stored and maintained. Control indicator  in instrument cluster illuminates green. Set speed is indicated on the display. Accelerator pedal can be released.

Vehicle speed can be increased by depressing the accelerator pedal. When the accelerator pedal is released, the previously stored speed is resumed.

Cruise control remains activated while gearshifting.

Increase speed



With cruise control active, hold thumb wheel turned to **RES/+** or briefly turn to **RES/+** repeatedly: speed increases continuously or in small increments.

Alternatively accelerate to the desired speed and store by turning to **SET/-**.

Reduce speed

With cruise control active, hold thumb wheel turned to **SET/-** or briefly turn to **SET/-** repeatedly: speed decreases continuously or in small increments.

Deactivation

Press ; control indicator  in instrument cluster illuminates white. Cruise control is deactivated. Last stored speed remains in memory for later speed resume.



Automatic deactivation:

- Vehicle speed is below approx. 25 km/h.
- The brake pedal is depressed.
- The clutch pedal is depressed for a few seconds.
- The selector lever is in **N**.
- Engine speed is in a very low range.
- The Traction Control system or Electronic Stability Control is operating.

Resume stored speed

Turn thumb wheel to **RES/+** at a speed above 25 km/h. The stored speed will be obtained.

Switching off

Press , control indicator  in instrument cluster extinguishes. The stored speed is deleted.

Pressing  to activate the speed limiter or switching off the ignition also switches off cruise control and deletes the stored speed.

Speed limiter

The speed limiter prevents exceeding a preset maximum speed.



The maximum speed can be set at speeds above 30 km/h.

The driver can only accelerate up to the preset speed. Deviations from the limited speed may occur when driving downhill.

The preset speed limit is displayed in the Driver Information Centre when the system is active.

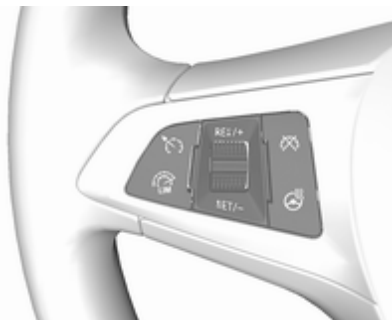
Activation



Press . If cruise control has been activated before, it is switched off when speed limiter is activated and control indicator  extinguishes.

Set speed limit

With speed limiter active, hold thumb wheel turned to **RES/+** or briefly turn to **RES/+** repeatedly until the desired maximum speed is displayed in the Driver Information Centre.

Alternatively, accelerate to the desired speed and briefly turn thumb wheel to **SET/-**: the current speed is

stored as maximum speed. Speed limit is displayed in the Driver Information Centre.



Change speed limit

With speed limiter active, turn thumb wheel to **RES/+** to increase or **SET/-** to decrease the desired maximum speed.

Exceeding the speed limit

When exceeding the limited speed without driver input, the speed will flash in the Driver Information Centre and a chime sounds during this period.

In the event of an emergency, it is possible to exceed the speed limit by depressing the accelerator pedal firmly nearly to the final point.

Release the accelerator pedal and the speed limiter function is reactivated once a speed lower than the limit speed is obtained.

Deactivation

Press : speed limiter is deactivated and the vehicle can be driven without speed limit.

The limited speed will be stored and is indicated in brackets in the Driver Information Centre. Additionally, a corresponding message appears.

Resume speed limit

Turn thumb wheel to **RES/+**. The stored speed limit will be obtained.

Switching off

Press , the speed limit indication extinguishes in the Driver Information Centre. The stored speed is deleted.

By pressing  to activate cruise control, speed limiter is also deactivated and the stored speed is deleted.

By switching off the ignition, speed limiter is also deactivated, but the speed limit will be stored for next speed limiter activation.

Parking assist

Rear parking assist

Warning

It is the driver who bears full responsibility for the parking manoeuvre.

Always check the surrounding area while reversing and using the rear parking assist system.

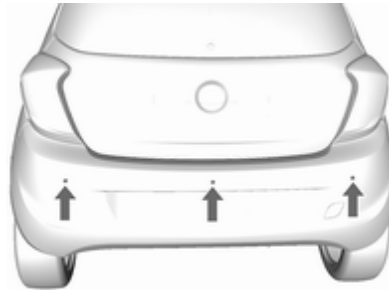

The rear parking assist makes parking easier by measuring the distance between the vehicle and rear obstacles. It informs and warns the driver by giving acoustic signals and display indication.

The system has three ultrasonic parking sensors in the rear bumper.

Activation

When reverse gear is engaged, the system is ready to operate automatically.

Indication



The system warns the driver with acoustic signals against potentially hazardous obstacles behind the vehicle. The interval between the sounds becomes shorter as the vehicle gets closer to that obstacle. When the distance is less than approx. 40 cm, the sound is continuous.

Deactivation

The system automatically switches off when reverse gear is disengaged.

The system might not detect the obstacle when the vehicle is driven above a 10 km/h.

Fault

In the event of a fault in the system, control indicator  illuminates in the instrument cluster  74.

Additionally if the system does not work due to temporary conditions like snow covered sensors,  illuminates.

Basic notes on parking assist systems

⚠ Warning

Under certain circumstances, various reflective surfaces on objects or clothing as well as external noise sources may cause the system to fail to detect obstacles.

Special attention must be paid to low obstacles which can damage the lower part of the bumper.

Caution

Performance of the system can be reduced when sensors are covered, e.g. by ice or snow.

Performance of the parking assist system can be reduced due to heavy loading.

Special conditions apply if there are taller vehicles in the vicinity (e.g. off-road vehicles, mini vans, vans). Object identification and

correct distance indication in the upper part of these vehicles cannot be guaranteed.

Objects with a very small reflection cross-section, e.g. objects of narrow size or soft materials, may not be detected by the system.

Parking assist systems do not detect objects outside the detection range.

Lane departure warning

The lane departure warning system observes the lane markings between which the vehicle is driving via a front camera. The system detects lane changes and warns the driver in the event of an unintended lane change via visual and acoustic signals.



Criteria for the detection of an unintended lane change are:

- No operation of turn signals.
- No brake pedal operation.
- No active accelerator operation or speeding-up.
- No active steering.

If the driver is performing these actions, no warning will be issued.

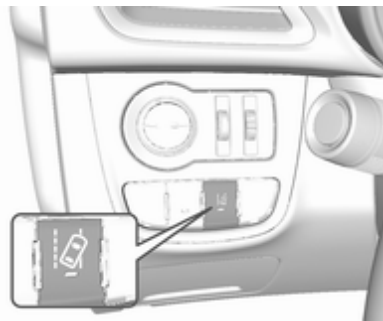
Activation



The lane departure warning system is activated by pressing . The illuminated LED in the button indicates that the system is switched on. When control indicator  in the instrument cluster illuminates green, the system is ready to operate.

The system is only operable at vehicle speeds above 56 km/h and if lane markings are available.

When the system recognises an unintended lane change, control indicator  changes to yellow and flashes. Simultaneously a chime sound is activated.



Deactivation

The system is deactivated by pressing , the LED in the button extinguishes.

At speeds below 56 km/h the system is inoperable.

Fault

The lane departure warning system may not operate properly when:

- The windscreen is not clean.
- There are adverse environmental conditions e.g. heavy rain, snow, direct sunlight or shadows.

The system can not operate when no lane marking is detected.

Fuel

Fuel for petrol engines

Only use unleaded fuel that complies with European standard EN 228 or equivalent.

The engine is capable of running with fuel that contains up to 10% ethanol (e.g. named E10).

Use fuel with the recommended octane rating. A lower octane rating can reduce engine power and torque and slightly increases fuel consumption.

Caution

Do not use fuel or fuel additives that contain metallic compounds such as manganese-based additives. This may cause engine damage.

Caution

Use of fuel that does not comply to EN 228 or equivalent can lead to deposits or engine damage.

Caution

Use of fuel with a lower octane rating than the lowest possible rating could lead to uncontrolled combustion and engine damage.

The engine specific requirements regarding octane rating are given in the engine data overview ↗ 184. A country specific label at the fuel filler flap can supersede the requirement.

Fuel additives outside Europe

Fuel should contain detergent additives that help prevent engine and fuel system deposits from forming. Clean fuel injectors and intake valves will allow the emission control system to work properly.

Some fuel does not contain sufficient quantities of additive to keep fuel injectors and intake valves clean.

To make up for this lack of detergency, add Fuel System Treatment PLUS to the fuel tank at every engine oil change or every 15,000 km, whichever occurs first. It is available at your workshop.

Fuels containing oxygenates such as ethers and ethanol, as well as reformulated fuel, are available in some cities. If these fuels comply with the previously described specification, then they are acceptable to use. However, E85 (85% ethanol) and other fuels containing more than 15% ethanol must be used only in FlexFuel vehicles.

Caution

Do not use fuel containing methanol. It can corrode metal parts in the fuel system and also damage plastic and rubber parts. This damage would not be covered by the vehicle warranty.

Some fuels, mainly high octane racing fuels, can contain an octane enhancing additive called methylcyclopentadienyl manganese tricarbonyl (MMT). Do not use fuels or fuel additives with MMT as they can reduce spark plug life and affect emission control system performance. The malfunction indicator light  may turn on ↗ 73. If this occurs, seek the assistance of a workshop.

Fuel for liquid gas operation

Liquid gas is known as LPG (Liquefied Petroleum Gas) or under its French name GPL (Gaz de Pétrole Liquéfié). LPG is also known as Autogas.

LPG consists mainly of propane and butane. The octane rating is between 105 and 115, depending on the butane proportion. LPG is stored liquid at around five to ten bar pressure.

The boiling point depends on the pressure and mixing ratio. At ambient pressure, it is between -42 °C (pure propane) and -0.5 °C (pure butane).

Caution

The system works at an ambient temperature of approx. -8°C to 100°C .

Full function of the LPG system can only be guaranteed with liquid gas which complies with the minimum requirements of DIN EN 589.

Fuel selector



Pressing **LPG** switches between petrol and liquid gas operation as soon as the required parameters (coolant temperature, gas

temperature and minimum engine speed) have been reached. The requirements are usually fulfilled after approx. 60 seconds (depending on exterior temperature) and the first firm press on the accelerator. The LED status shows the current operating mode.

LED off : petrol operation
 LED : checking conditions for fuel transition to liquid gas operation.
 flashes : Illuminates if conditions are fulfilled.

LED illuminates : liquid gas operation

LED flashes five times and extinguishes : liquid gas tank is empty or failure in liquid gas system. A message is displayed in the Driver Information Centre.

If the fuel tank is empty, the engine will not start.

The selected fuel mode is stored and reactivated at the next ignition cycle if conditions allow.

As soon as the liquid gas tanks are empty, petrol operation is automatically engaged until the ignition is switched off.

When switching automatically between petrol or gas operation, a brief delay of engine tractive power may be noticeable.

Every six months, run the petrol tank down until control indicator  illuminates, then refuel. This helps maintain fuel quality and system function for petrol operation.

Fill the tank completely at regular intervals to prevent corrosion in the tank.

Faults and remedies

If gas mode is not possible, check the following:

- Is there enough liquid gas present?
- Is there enough petrol present for starting?

Due to extreme temperatures in combination with the gas composition, it may take slightly longer before the system switches from petrol to gas mode.

In extreme situations, the system may also switch back to petrol mode if the minimum requirements are not fulfilled. If conditions allow, it might be possible to manually switch back to liquid gas operation.

Seek the assistance of a workshop in the event of all other faults.

Caution

Repairs and adjustments may only be made by trained specialists in order to maintain the safety and warranty on the LPG system.

Liquid gas is given a particular odour (odorised) so that any leaks can be detected easily.

⚠ Warning

If you smell gas in the vehicle or in the immediate vicinity, switch to petrol mode immediately. No smoking. No naked flames or ignition sources.

If the gas odour persists, do not start the engine. Have the cause of the fault remedied by a workshop.

When using underground car parks, follow the instructions of the operator and local laws.

Note

In the event of an accident, switch off the ignition and lights.

Refuelling

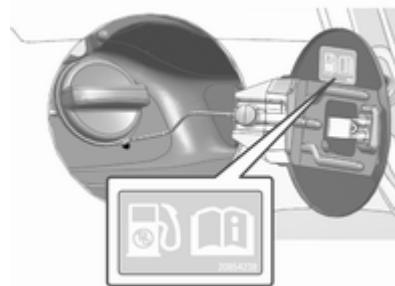

⚠ Danger

Before refuelling, switch off ignition and any external heaters with combustion chambers.

Follow the operating and safety instructions of the filling station when refuelling.

⚠ Danger

Fuel is flammable and explosive. No smoking. No naked flames or sparks.

If you can smell fuel in your vehicle, have the cause of this remedied immediately by a workshop.

Caution

In case of misfuelling, do not switch on ignition.

1. Stop the engine.



2. Pull up the fuel filler flap release lever located on the floor, left front side of driver's seat.

The fuel filler flap is located at right rear side of the vehicle.

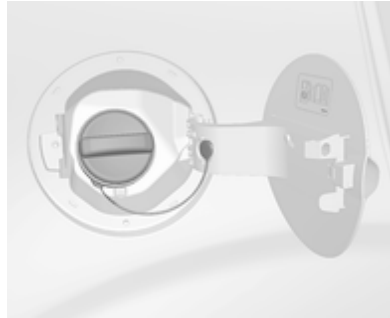

3. Turn the fuel filler cap counterclockwise slowly. If a hissing sound is heard, wait for it to stop before completely unscrewing the cap.
4. Remove the cap. The cap is tethered to the vehicle.

5. After refuelling, replace cap. Turn it clockwise until you hear several clicks.
6. Push the fuel filler flap closed until it latches.

Note

If, in cold weather, the fuel filler door does not open, tap the door lightly. Then try to open it again.

Caution

Wipe off any overflowing fuel immediately.

Liquid gas refuelling

Follow the operating and safety instructions of the filling station when refuelling.

The filling valve for the liquid gas is behind the fuel filler cap.

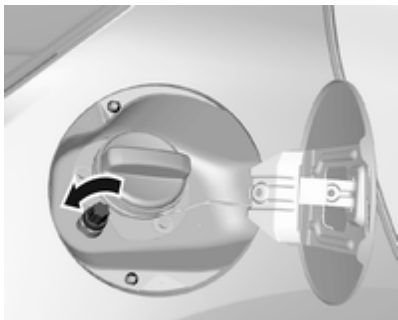

Unscrew protective cap from the filler neck.

Caution

Screw and unscrew the protective cap by hand only.

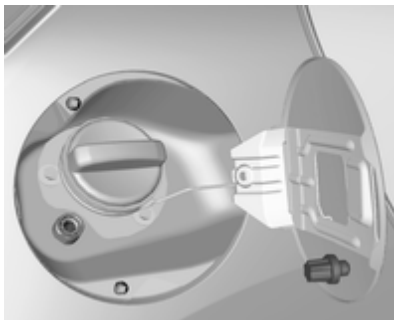

Protective cap is magnetic. Place it on fuel filler door while refuelling.

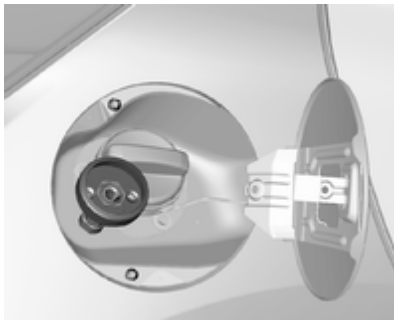

Screw the required adapter hand-tight onto the filler neck.

ACME Adapter: Screw the nut of the filling nozzle onto the adapter. Press locking lever on filler nozzle down.

DISH filler neck: Place the filler nozzle into the adapter. Press locking lever on filler nozzle down.

Bayonet filler neck: Place filler nozzle on the adapter and turn clockwise or anticlockwise through one quarter turn. Pull locking lever of filler nozzle fully.

EURO filler neck: Press the filler nozzle onto the adapter until it engages.

Press the button at the liquid gas supply point. The filling system stops or begins to run slowly when 80% of the tank volume is reached (maximum fill level).

Release button on filling system and the filling process stops. Release the locking lever and remove the filler nozzle. A small quantity of liquid gas may escape.

Remove adapter and stow securely in vehicle.

Fit protective cap to prevent the penetration of foreign bodies into the filler opening and the system.

⚠ Warning

Due to the system design, an escape of liquid gas after releasing the locking lever is unavoidable. Avoid inhaling.

⚠ Warning

The liquid gas tank should only be filled to 80% capacity, for safety reasons.

The multivalve on the liquid gas tank automatically limits the fill quantity. If a larger quantity is added, we recommend not exposing the vehicle to the sun until the excess amount has been used up.

Filling adapter

As filling systems are not standardised, different adapters are required which are available from Opel Distributors and from Opel Authorised Repairers.

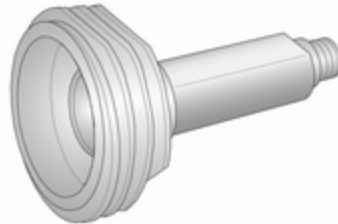

ACME adapter: Belgium, Germany, Ireland, Luxembourg, Switzerland

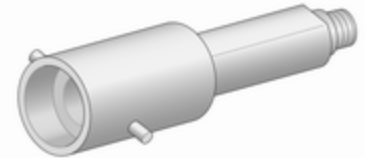

Bayonet adapter: Netherlands, Norway, Spain, United Kingdom

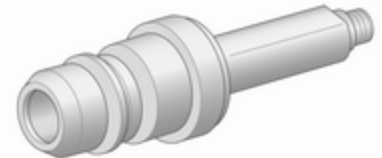

EURO adapter: Spain

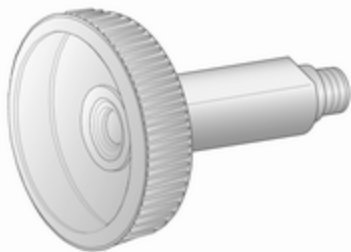

DISH adapter: Austria, Bosnia-Herzegovina, Bulgaria, Croatia, Czech Republic, Denmark, Estonia, France, Greece, Hungary, Italy, Latvia, Lithuania, Macedonia, Poland, Portugal, Romania, Serbia, Slovakia, Slovenia, Sweden, Switzerland, Turkey, Ukraine

Fuel filler cap

Only use genuine fuel filler caps.

Fuel consumption - CO₂-Emissions

The fuel consumption (combined) of the model Opel Karl is within a range of 4.6 to 4.1 l/100 km.

Depending on country, the fuel consumption is displayed in km/l. In this case the fuel consumption (combined) of the model Opel Karl is within a range of 21,7 to 24.3 km/l.

The CO₂ emission (combined) is within a range of 106 to 94 g/km.

For the values specific for your vehicle, refer to the EEC Certificate of Conformity provided with your vehicle or other national registration documents.

General information

The official fuel consumption and specific CO₂ emission figures quoted relate to the EU base model with standard equipment.

Fuel consumption data and CO₂ emission data are determined according to regulation R (EC) No. 715/2007 (in the latest applicable

version), taking into consideration the vehicle weight in running order, as specified by the regulation.

The figures are provided only for the purpose of comparison between different vehicle variants and must not be taken as a guarantee for the actual fuel consumption of a particular vehicle. Additional equipment may result in slightly higher results than the stated consumption and CO₂ figures.

Furthermore, fuel consumption is dependent on personal driving style as well as road and traffic conditions.

Vehicle care

General Information	137
Accessories and vehicle modifications	137
Vehicle storage	138
End-of-life vehicle recovery	138
Vehicle checks	139
Performing work	139
Bonnet	139
Engine oil	140
Engine coolant	141
Washer fluid	141
Brakes	142
Brake fluid	142
Vehicle battery	142
Wiper blade replacement	144
Bulb replacement	144
Halogen headlights	145
Fog lights	146
Front turn signal lights	147
Tail lights	147
Side turn signal lights	148
Centre high-mounted brake light	149
Number plate light	149

Interior lights	150
Instrument panel illumination ...	150
Electrical system	150
Fuses	150
Engine compartment fuse box .	152
Instrument panel fuse box	153
Vehicle tools	155
Tools	155
Wheels and tyres	156
Winter tyres	156
Tyre designations	156
Tyre pressure	156
Tyre pressure monitoring system	157
Tread depth	161
Changing tyre and wheel size .	161
Wheel covers	161
Tyre chains	162
Tyre repair kit	162
Wheel changing	165
Spare wheel	167
Jump starting	169
Towing	171
Towing the vehicle	171
Appearance care	172
Exterior care	172
Interior care	174

General Information

Accessories and vehicle modifications

We recommend the use of genuine parts and accessories and factory approved parts specific for your vehicle type. We cannot assess or guarantee reliability of other products - even if they have a regulatory or otherwise granted approval.

Any modification, conversion or other changes made to standard vehicle specifications (including, without limitation, software modifications, modifications of the electronic control units) may invalidate the warranty offered by Opel. Furthermore, such changes may affect driver assistance systems, fuel consumption, CO₂ emissions and other emissions of the vehicle. They may also invalidate the vehicle operating permit.

Caution
When transporting the vehicle on a train or on a recovery vehicle, the mud flaps might be damaged.

Vehicle storage

Storage for a long period of time

If the vehicle is to be stored for several months:

- Wash and wax the vehicle.
- Have the wax in the engine compartment and underbody checked.
- Clean and preserve the rubber seals.
- Fill up fuel tank completely.
- Change the engine oil.
- Drain the washer fluid reservoir.
- Check the coolant antifreeze and corrosion protection.
- Adjust tyre pressure to the value specified for full load.

- Park the vehicle in a dry, well ventilated place. Engage first or reverse gear. Prevent the vehicle from rolling.
- Do not apply the parking brake.
- Open the bonnet, close all doors and lock the vehicle.
- Disconnect the clamp from the negative terminal of the vehicle battery. Beware that all systems are not functional, e.g. anti-theft alarm system.

Putting back into operation

When the vehicle is to be put back into operation:

- Connect the clamp to the negative terminal of the vehicle battery. Activate the electronics of the power windows.
- Check tyre pressure.
- Fill up the washer fluid reservoir.
- Check the engine oil level.
- Check the coolant level.
- Fit the number plate if necessary.

End-of-life vehicle recovery

Information on end-of-life vehicle recovery centres and the recycling of end-of-life vehicles is available on our website. Only entrust this work to an authorised recycling centre.

Gas vehicles must be recycled by a service centre authorised for gas vehicles.

Vehicle checks

Performing work

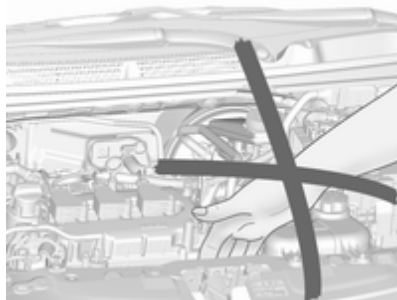

⚠ Warning

Only perform engine compartment checks when the ignition is off.

The cooling fan may start operating even if the ignition is off.

⚠ Danger

The ignition system uses extremely high voltage. Do not touch.

Bonnet

Opening



Pull the release lever and return it to its original position.



Move the safety catch sideways to the left vehicle side and open the bonnet.

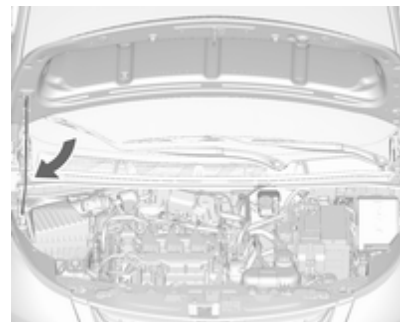

Warning

When the engine is hot, touch the bonnet support rod at the foam padding only.

Lift the bonnet, remove the bonnet support rod from the holder and secure the bonnet support rod properly.

If the bonnet is opened during an Autostop, the engine will be restarted automatically for safety reasons.

Closing

Before closing the bonnet, make sure that all caps are closed properly, then press the support into the holder.

Lower the bonnet and allow it to fall into the latch from a low height (20-25 cm). Check that the bonnet is engaged.

Caution

Do not press the bonnet into the latch, to avoid dents.

Engine oil

Check the engine oil level manually on a regular basis to prevent damage to the engine.

Ensure that the correct specification of oil is used. Recommended fluids and lubricants ⇨ 176.

The maximum engine oil consumption is 0.6 l per 1000 km.

Check with the vehicle on a level surface. The engine must be at operating temperature and switched off for at least five minutes.

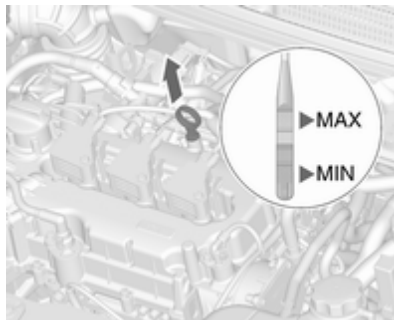

Pull out the dipstick, wipe it clean, reinsert it fully, pull out and read the engine oil level.

When the engine oil level has dropped to the **MIN** mark, top up engine oil.

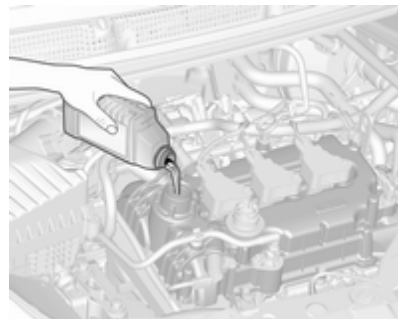

We recommend the use of the same grade of engine oil that was used at last change.

The engine oil level must not exceed the **MAX** mark on the dipstick.

Caution

Overfilled engine oil must be drained or suctioned out.

Capacities ⇨ 187.

Fit the cap on straight and tighten it.

Engine coolant

The coolant provides freeze protection down to approx. -28°C . In northern countries with very low temperatures the factory filled coolant provides frost protection down to approx. -37°C .

Caution

Only use approved antifreeze.

Coolant and antifreeze ⇨ 176.

Coolant level

Caution

Too low a coolant level can cause engine damage.

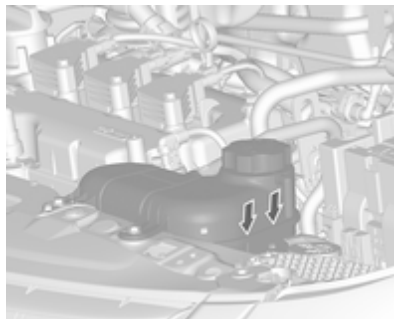

If the cooling system is cold, the coolant level should be above the filling line mark. Top up if the level is low.

⚠ Warning

Allow the engine to cool before opening the cap. Carefully open the cap, relieving the pressure slowly.

To top up use a 1:1 mixture of released coolant concentrate mixed with clean tap water. If no coolant concentrate is available, use clean tap water. Install the cap tightly. Have

the coolant concentration checked and have the cause of the coolant loss remedied by a workshop.

Washer fluid

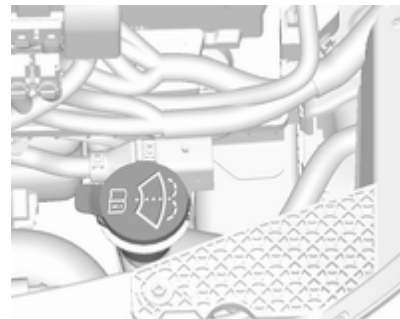

Fill with clean water mixed with a suitable quantity of approved windscreen washer fluid which contains antifreeze.

Caution

Only washer fluid with a sufficient antifreeze concentration provides protection at low temperatures or a sudden drop in temperature.

Washer fluid ⇨ 176.

Brakes

In the event of minimum thickness of the brake lining, a squealing noise sounds during braking.

Continued driving is possible but have the brake lining replaced as soon as possible.

Once new brake linings are installed, do not brake unnecessarily hard for the first few journeys.

Brake fluid**⚠ Warning**

Brake fluid is poisonous and corrosive. Avoid contact with eyes, skin, fabrics and painted surfaces.

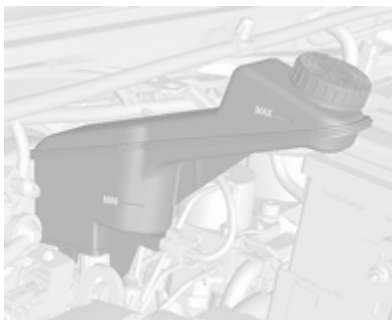

The brake fluid level must be between the **MIN** and **MAX** marks.

If fluid level is below **MIN** seek the assistance of a workshop.

Brake and clutch fluid ⇨ 176.

Vehicle battery

The vehicle battery is maintenance-free provided that the driving profile allows sufficient charging of the battery. Short-distance-driving and frequent engine starts can discharge the vehicle battery. Avoid the use of unnecessary electrical consumers.



Batteries do not belong in household waste. They must be disposed of at an appropriate recycling collection point.

Laying up the vehicle for more than four weeks can lead to vehicle battery discharge. Disconnect the clamp from the negative terminal of the vehicle battery.

Ensure the ignition is switched off before connecting or disconnecting the vehicle battery.

Battery discharge protection ⇨ 98.

Disconnecting the battery

If the vehicle's battery is to be disconnected (e.g. for maintenance work), the alarm siren must be deactivated as follows: Switch the ignition on then off, then disconnect the vehicle's battery within 15 seconds.

Replacing the vehicle battery

Note

Any deviation from the instructions given in this section may lead to temporary deactivation or disturbance of the stop-start system.

When the vehicle battery is being replaced, please ensure that there are no open ventilation holes in the vicinity of the positive terminal. If a ventilation hole is open in this area, it must be closed off with a dummy cap, and the ventilation in the vicinity of the negative terminal must be opened.

Ensure that the battery is always replaced by the same type of battery.

We recommend the use of an original Opel battery.

Note

Using an AGM vehicle battery different from the original Opel vehicle battery may result in a lower performance.

We recommend that you have the vehicle battery replaced by a workshop.

Charging the vehicle battery

⚠ Warning

On vehicles with stop-start system, ensure that the charging potential does not exceed 14.6 volts when using a battery charger. Otherwise the battery might be damaged.

Jump starting ⇨ 169.

Stop-start system ⇨ 111.

Warning label



Meaning of symbols:

- No sparks, naked flames or smoking.
- Always shield eyes. Explosive gases can cause blindness or injury.
- Keep the vehicle battery out of the reach of children.
- The vehicle battery contains sulfuric acid which could cause blindness or serious burn injuries.
- See the Owner's manual for further information.
- Explosive gas may be present in the vicinity of the battery.

Wiper blade replacement



Lift the wiper arm. Press release lever and detach the wiper blade.

Attach the wiper blade slightly angled to the wiper arm and push until it engages.

Lower wiper arm carefully.

Wiper blade on the rear window



Lift wiper arm. Push the wiper blade, slightly angled to the wiper arm downwards until it disengages.

Attach the wiper blade slightly angled to the wiper arm and push until it engages.

Lower wiper arm carefully.

Bulb replacement

Switch off the ignition and switch off the relevant switch or close the doors. Only hold a new bulb at the base! Do not touch the bulb glass with bare hands.

Use only the same bulb type for replacement.

Replace headlight bulbs from within the engine compartment.

Bulb check

After a bulb replacement switch on the ignition, operate and check the lights.

Halogen headlights

Low beam and high beam

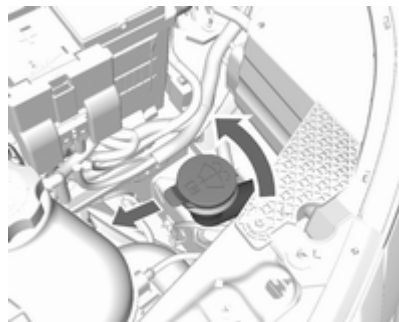

1. On left vehicle side: rotate and pull out the filling pipe of the windscreen washer fluid container.

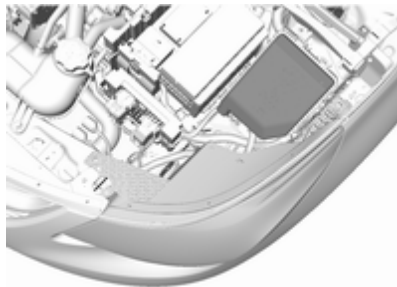

2. Remove fuse box cover (left side of the vehicle only).

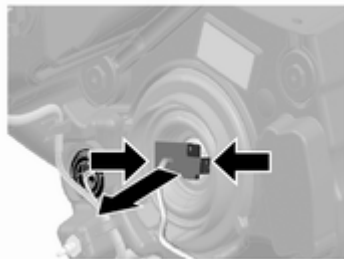

3. Press both clips together and detach plug connector from bulb.

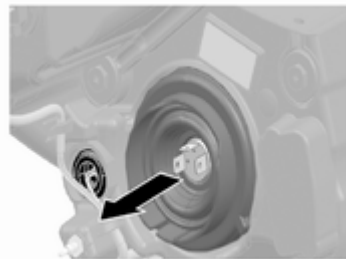

4. Remove protective cover.



5. Press spring clip and disengage.

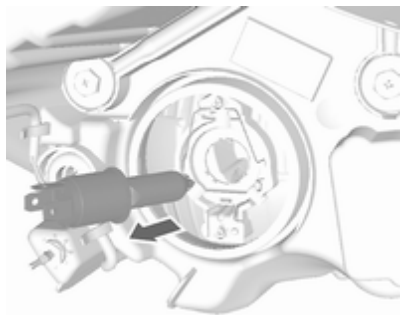

6. Remove bulb from reflector housing.
7. When fitting a new bulb, engage the lugs in the recesses on the reflector.
8. Engage the spring clip.
9. Place headlight protective cover in position and close.
10. Ensure the protective cover is placed correctly to prevent water leak and heavy condensations.

Sidelight/Daytime running light

1. Remove fuse box cover (left side of the vehicle only).

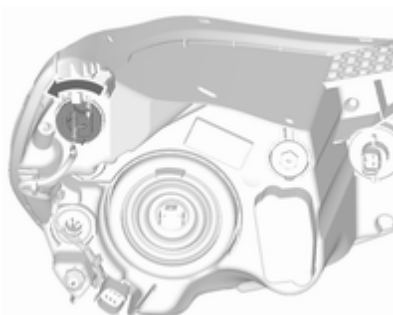

2. Rotate the bulb holder anticlockwise and remove.

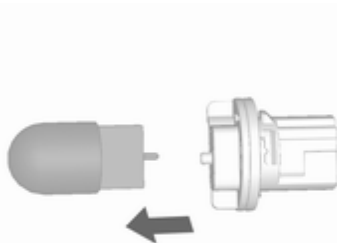

3. Detach bulb from the bulb holder and replace it.
4. Insert the bulb socket into the reflector and turn clockwise.

Sidelight/daytime running light with LEDs

Sidelights and daytime running lights are designed as LEDs and cannot be changed. Consult a workshop in case of a defective LED.

Fog lights

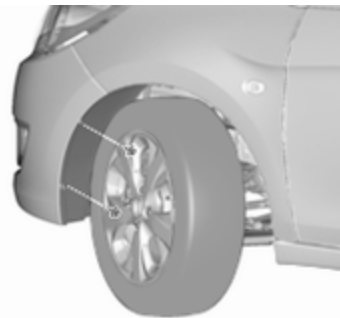

1. Tilt the wheel and remove the two push nuts on the outside of the wheel liner.



2. Disconnect the electrical connector from the bulb holder.
3. Remove the bulb assembly anticlockwise and pull it straight out.
4. Insert a new bulb assembly straight into the lamp and rotate clockwise.
5. Reconnect the electrical connector.

Front turn signal lights

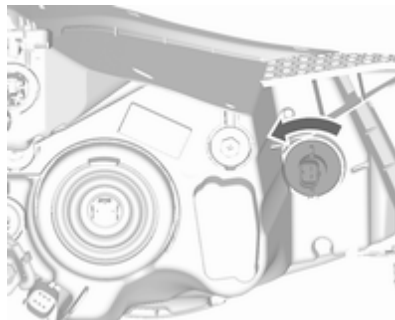

1. Rotate the bulb holder anticlockwise and remove.

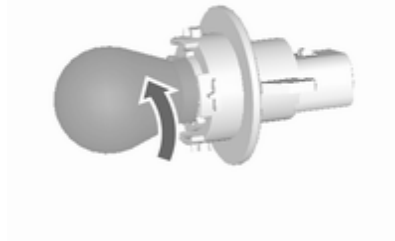

2. Rotate bulb anticlockwise and remove from bulb holder.
3. Replace bulb.
4. Insert the bulb holder into the reflector and rotate clockwise.

Tail lights

Tail lights, turn signal lights, brake lights and reversing lights



1. Unscrew both screws.
2. Remove tail light assembly. Take care that the cable duct remains in position.

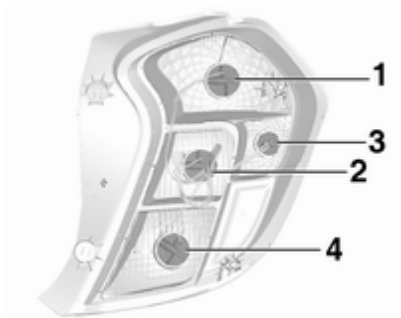

3. tail light / brake light 1
 turn signal light 2
 tail light 3
 reversing light (passenger side) /
 rear fog light (driver's side) 4.

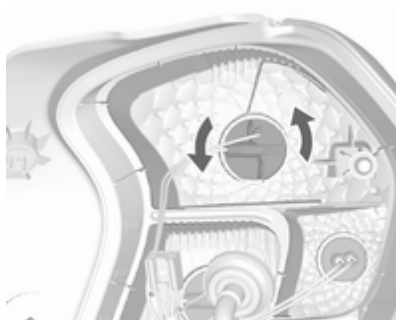

4. Rotate bulb holder anticlockwise.

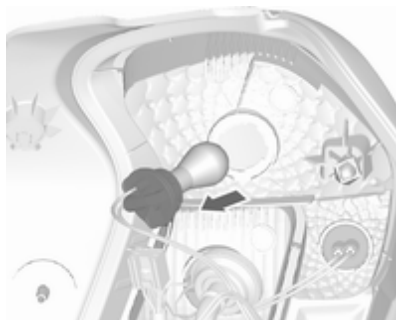

5. Remove bulb holder. Push bulb into socket slightly, rotate anticlockwise, remove and renew bulb.

6. Insert bulb holder into the tail light assembly and screw into place.

Connect wiring plug. Install tail light assembly in body and tighten screws. Close covers and engage.

7. Switch on ignition, operate and check all lights.

Side turn signal lights

To replace bulb, remove lamp housing:

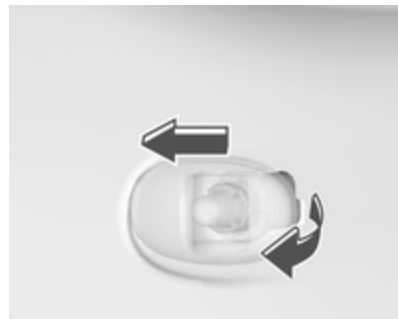

1. Slide lamp to the front and remove it out of the front wing with the rear end.



2. Turn bulb holder anticlockwise and remove from housing.

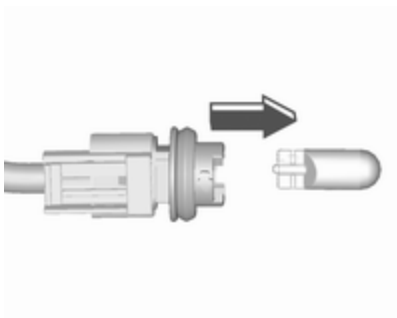

3. Pull bulb from bulb holder and replace it.

4. Insert bulb holder and turn clockwise.
5. Insert front end into front wing, slide forward and insert rear end.

Centre high-mounted brake light



Have LEDs replaced by a workshop.

Number plate light



1. Unscrew both screws.
2. Remove bulb housing downwards, taking care not to pull on the cable.
Rotate bulb holder anticlockwise to disengage.
3. Remove bulb from bulb holder and replace it.
4. Insert bulb holder into bulb housing and turn clockwise.
5. Insert bulb housing and secure using a screwdriver.

Interior lights

Courtesy light, reading lights

1. To remove, prise the opposite side of the lamp switch using a flat-blade screwdriver. (Be careful not to make scratches.)
2. Remove the bulb.
3. Replace the bulb.
4. Reinstall the lamp assembly.

Load compartment light

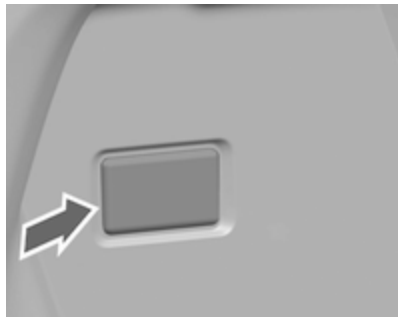

1. Prise the lamp out with a screwdriver.



2. Remove bulb.
3. Insert new bulb.
4. Install lamp.

Instrument panel illumination

Have bulbs replaced by a workshop.

Electrical system

Fuses

Data on the replacement fuse must match the data on the defective fuse.

There are two fuse boxes in the vehicle:

- In the front left of the engine compartment.
- On the driver's side behind a cover in the instrument panel.

Before replacing a fuse, turn off the respective switch and the ignition.

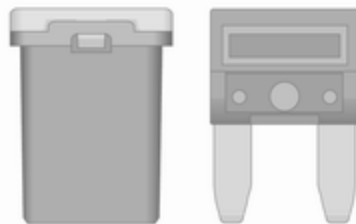

There are different kinds of fuses in the vehicle. Some types of fuses in the vehicle may differ from the ones illustrated.



Depending on the type of fuse, a blown fuse can be recognized by its melted wire. Do not replace the fuse until the cause of the fault has been remedied.

Some functions are protected by several fuses.

Fuses may also be inserted without existence of a function.

Fuse extractor

A fuse extractor may be located in the fuse box in the engine compartment.

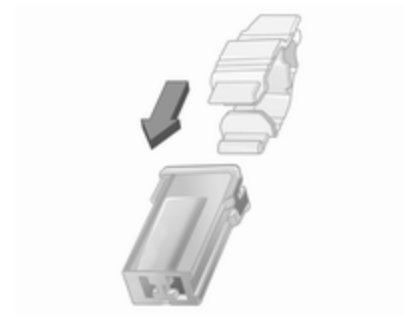
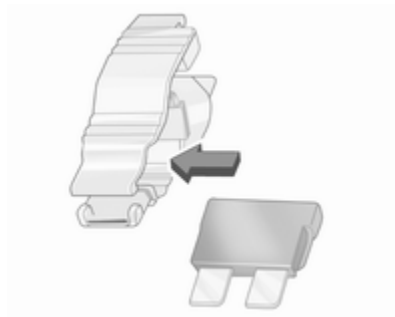
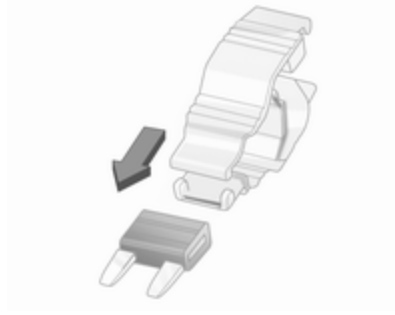

Place the fuse extractor on the various types of fuse from the top, and withdraw fuse.

Engine compartment fuse box

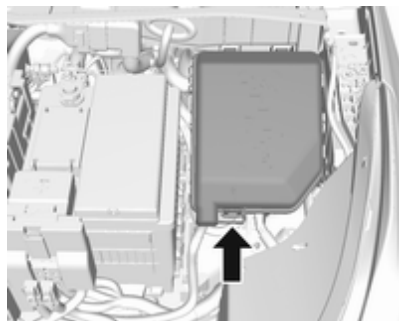

The fuse box is in the front left of the engine compartment.

Disengage the cover, lift it upwards and remove.

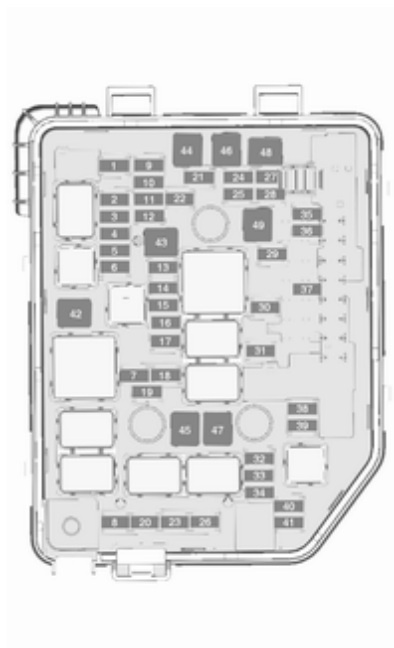

No. Circuit

- | No. | Circuit |
|-----|---|
| 1 | Tailgate |
| 2 | - |
| 3 | Heated rear window |
| 4 | Heated exterior mirror |
| 5 | Sunroof |
| 6 | Transmission control module |
| 7 | Engine control module |
| 8 | - |
| 9 | ABS |
| 10 | Body control module, voltage |
| 11 | Rear view camera |
| 12 | - |
| 13 | - |
| 14 | Engine control module/Transmission control module |
| 15 | Injection system/Starter |
| 16 | Fuel pump |
| 17 | Engine control module1 |

No. Circuit

- 18 Engine control module2
- 19 Injection system/Ignition
- 20 Air conditioning system
- 21 Battery sensor
- 22 Electric steering column lock
- 23 Cooling fan low
- 24 –
- 25 Exterior mirror switch
- 26 Engine control module/Manual transmission automated module
- 27 Fuel system
- 28 Brake system
- 29 Seat occupancy recognition
- 30 Headlight range adjustment
- 31 Horn
- 32 Front fog light
- 33 High beam left

No. Circuit

- 34 High beam right
- 35 –
- 36 Rear wiper
- 37 Cornering light left
- 38 Washer system
- 39 Cornering light right
- 40 –
- 41 –
- 42 Starter 2
- 43 Instrument panel
- 44 Manual transmission automated, DC-DC converter
- 45 Starter 1
- 46 ABS
- 47 Cooling fan high
- 48 Front wiper
- 49 Body control module/Retained power off

After having changed defective fuses close the fuse box cover and press until it engages.

If the fuse box cover is not closed correctly, malfunction may occur.

Instrument panel fuse box

The fuse box is located on the driver's side behind a cover in the instrument panel.

To open the compartment, compress the locking tabs, fold cover down and remove.

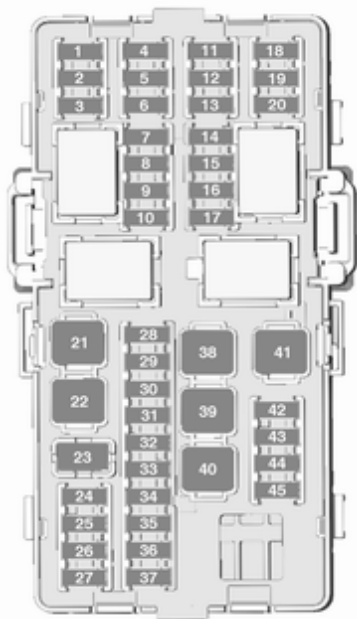

No. Circuit

- 1 Onstar
- 2 Air conditioning system
- 3 Instrument cluster
- 4 Transmission control module
- 5 Infotainment
- 6 –
- 7 Rear parking assist
- 8 Data link connection
- 9 Electric steering column lock
- 10 Sensing and Diagnostic module
- 11 DC transformer
- 12 –
- 13 –
- 14 Linear power module
- 15 Central locking system/Ignition system
- 16 Ignition system

No. Circuit

- 17 –
- 18 Instrument cluster
- 19 –
- 20 Headlight range adjustment
- 21 Power windows, front
- 22 Power windows, rear
- 23 –
- 24 Manual transmission automated module
- 25 Auxiliary power outlet
- 26 Sunroof
- 27 –
- 28 Body control module 8
- 29 Body control module 7
- 30 Body control module 6
- 31 Body control module 5
- 32 Body control module 4

No. Circuit

- 33 Body control module 3
- 34 Body control module 2
- 35 Body control module 1
- 36 –
- 37 Steering wheel control LED
- 38 –
- 39 Logistic/DC transformer
- 40 Power window, driver
- 41 Blower
- 42 Seat heating, front
- 43 Air conditioning module
- 44 Heated steering wheel
- 45 –

Vehicle tools

Tools

Vehicles without spare

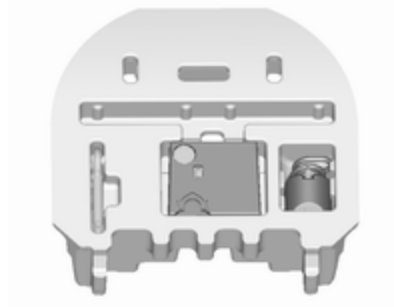

The vehicle tools are in the compartment under the floor cover in the load compartment.

Vehicles with spare wheel



The jack and the vehicle tools are in the load compartment.

Wheels and tyres

Tyre condition, wheel condition

Drive over edges slowly and at right angles if possible. Driving over sharp edges can cause tyre and wheel damage. Do not trap tyres on the kerb when parking.

Regularly check the wheels for damage. Seek the assistance of a workshop in the event of damage or unusual wear.

We recommend not swapping the front wheels with the rear wheels and vice versa, as this can affect vehicle stability. Always use less worn tyres on the rear axle.

Winter tyres

Winter tyres improve driving safety at temperatures below 7 °C and should therefore be fitted on all wheels.

In accordance with country-specific regulations, affix the speed sticker in the driver's field of view.

Tyre designations

E.g. **195/55 R 16 95 H**

- 195** : tyre width, mm
- 55** : cross-section ratio (tyre height to tyre width), %
- R** : belt type: Radial
- RF** : type: RunFlat
- 16** : wheel diameter, inches
- 91** : load index e.g. 91 is equivalent to 615 kg
- H** : speed code letter

Speed code letter:

- Q** : up to 160 km/h
- S** : up to 180 km/h
- T** : up to 190 km/h
- H** : up to 210 km/h
- V** : up to 240 km/h
- W** : up to 270 km/h

Choose a tyre appropriate for the maximum speed of your vehicle.

The maximum speed is achievable at kerb weight with driver (75 kg) plus 125 kg payload. Optional equipment could reduce the maximum speed of the vehicle.

Performance ⇨ 185.

Directional tyres

Directional tyres must be mounted so that they rotate in the correct direction. The proper rotation direction is indicated by a symbol (e.g. an arrow) on the sidewall.

Tyre pressure

Check the pressure of cold tyres at least every 14 days and before any long journey.

Do not forget the spare wheel.

This also applies to vehicles with tyre pressure monitoring system.

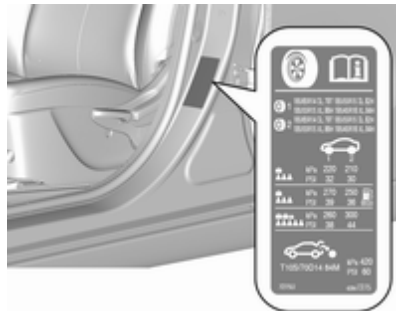

Tyre pressure ⇨ 188.

The tyre pressure information label on the driver's door frame indicates the original equipment tyres and the correspondent tyre pressures.

The tyre pressure data refers to cold tyres. It applies to summer and winter tyres.

The ECO tyre pressure serves to achieve the smallest amount of fuel consumption possible.

Incorrect tyre pressures will impair safety, vehicle handling, comfort and fuel economy and will increase tyre wear.

Tyre pressures differ depending on various options.

For the correct tyre pressure value, follow the procedure below:

- Identify the engine identifier code. Engine data ⇨ 184.
- Identify the respective tyre.

For the tyres approved for your vehicle, refer to the EEC Certificate of Conformity provided with your vehicle or other national registration documents.

The driver is responsible for correct adjustment of tyre pressure.

Warning

If the pressure is too low, this can result in considerable tyre warm-up and internal damage, leading to tread separation and even to tyre blow-out at high speeds.

Warning

For specific tyres the recommended tyre pressure as shown in the tyre pressure table may exceed the maximum tyre pressure as indicated on the tyre. Never exceed the maximum tyre pressure as indicated on the tyre.

If the tyre pressure must be reduced or increased, switch off ignition. After adjusting tyre pressure switch on ignition and select the relevant setting on the page **Tyre Load** in the Driver Information Centre ⇨ 77.

Temperature dependency

The tyre pressure depends on the temperature of the tyre. During driving, tyre temperature and pressure increase. Tyre pressure values provided on the tyre information label and tyre pressure chart are valid for cold tyres, which means at 20 °C.

The pressure increases by nearly 10 kPa for a 10 °C temperature increase. This must be considered when warm tyres are checked.

The tyre pressure value displayed in the Driver Information Centre shows the real tyre pressure. A cooled down tyre will show a decreased value, which does not indicate an air leak.

Tyre pressure monitoring system

The tyre pressure monitoring system checks the pressure of all four tyres once a minute when vehicle speed exceeds a certain limit.

Caution

Tyre pressure monitoring system warns only about low tyre pressure condition and does not replace regular tyre maintenance by the driver.

All wheels must be equipped with pressure sensors and the tyres must have the prescribed pressure.

Note

In countries where the tyre pressure monitoring system is legally required, the use of wheels without pressure sensors will invalidate the vehicle operating permit.

The current tyre pressures can be shown in the **Vehicle Information Menu** in the Driver Information Centre.

The menu can be selected by pressing the buttons on the turn signal lever.



Press **MENU** to select the **Vehicle Information Menu** .

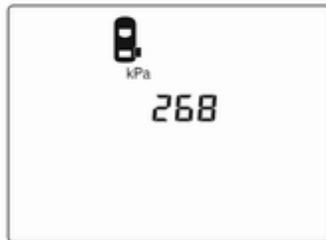



Turn the adjuster wheel to select the tyre pressure monitoring system.

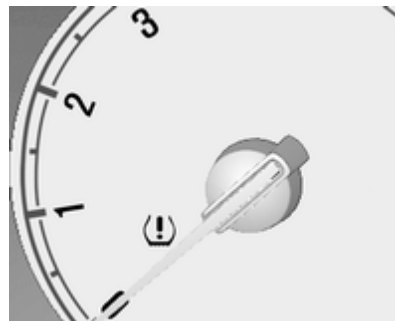

System status and pressure warnings are displayed by a message with the corresponding tyre flashing in the Driver Information Centre.

The system considers the tyre temperature for the warnings.

Temperature dependency  156.



A detected low tyre pressure condition is indicated by the control indicator   75.

If  illuminates, stop as soon as possible and inflate the tyres as recommended  188.

If Ⓛ flashes for 60-90 seconds then illuminates continuously, there is a fault in the system. Consult a workshop.

After inflating, some driving may be required to update the tyre pressure values in the Driver Information Centre. During this time Ⓛ may illuminate.

If Ⓛ illuminates at lower temperatures and extinguishes after some driving, this could be an indicator for approaching a low tyre pressure condition. Check tyre pressure.

Vehicle messages ⇨ 83.

If the tyre pressure must be reduced or increased, switch off ignition.

Only mount wheels with pressure sensors, otherwise the tyre pressure will not be displayed and Ⓛ illuminates continuously.

A temporary spare wheel is not equipped with pressure sensors. The tyre pressure monitoring system is not operational for these tyres.

Control indicator Ⓛ illuminates. For the further three tyres, the system remains operational.

The use of commercially-available liquid tyre repair kits can impair the function of the system. Factory-approved repair kits can be used.

Operating electronic devices or being close to facilities using similar wave frequencies could disrupt the tyre pressure monitoring system.

Each time the tyres are replaced, tyre pressure monitoring system sensors must be dismantled and serviced. For the screwed sensor; replace valve core and sealing ring. For the clipped sensor; replace complete valve stem.

Vehicle loading status

Adjust tyre pressure to load condition according to the tyre information label or tyre pressure chart ⇨ 188, and select the appropriate setting in the menu **Tyre Load** in the Driver Information Centre, **Vehicle Information Menu** ⇨ 77. This setting is the reference for the tyre pressure warnings.

The **Tyre Load** menu only appears if the vehicle is in a standstill and the parking brake is applied. On vehicles with automatic transmission the selector lever has to be in **P**.



Select:

- **Lo** for comfort pressure up to 3 people.
- **Eco** for Eco pressure up to 3 people.
- **Hi** for full loading.

Tyre pressure sensor matching process

Each tyre pressure sensor has a unique identification code. The identification code must be matched to a new tyre/wheel position after rotating the tyres or exchanging the complete wheel set and if one or more tyre pressure sensors were replaced. The tyre pressure sensor matching process should also be performed after replacing a spare tyre with a road tyre containing the tyre pressure sensor.

The malfunction light (⚠) and the warning message or code should go off at the next ignition cycle. The sensors are matched to the wheel positions, using a relearn tool, in the following order: left side front wheel, right side front wheel, right side rear wheel and left side rear wheel. The turn signal light at the current active position is illuminated until sensor is matched.

Consult a workshop for service. There are two minutes to match the first wheel position, and five minutes overall to match all four wheel

positions. If it takes longer, the matching process stops and must be restarted.

The tyre pressure sensor matching process is:

1. Apply the parking brake.
2. Turn the ignition on.
3. On vehicles with manual transmission: select neutral.
4. Use **MENU** on the turn signal lever to select the **Vehicle Information Menu** in the Driver Information Centre.
5. Turn the adjuster wheel to scroll to the tyre pressure menu.
6. Press **SET/CLR** to begin the sensor matching process. A message requesting acceptance of the process should be displayed.
7. Press **SET/CLR** again to confirm the selection. The horn sounds twice to indicate that the receiver is in relearn mode.
8. Start with the left side front wheel.

9. Place the relearn tool against the tyre sidewall, near the valve stem. Then press the button to activate the tyre pressure sensor. A horn chirp confirms that the sensor identification code has been matched to this wheel position.
10. Proceed to the right side front wheel, and repeat the procedure in Step 9.
11. Proceed to the right side rear wheel, and repeat the procedure in Step 9.
12. Proceed to the left side rear wheel, and repeat the procedure in Step 9. The horn sounds twice to indicate that the sensor identification code has been matched to the left side rear wheel, and the tyre pressure sensor matching process is no longer active.
13. Turn off the ignition.

14. Set all four tyres to the recommended air pressure level as indicated on the tyre information label.
15. Ensure the tyre loading status is set according to the selected pressure ⇨ 77.

Tread depth

Check tread depth at regular intervals.

Tyres should be replaced for safety reasons at a tread depth of 2-3 mm (4 mm for winter tyres).

For safety reasons it is recommended that the tread depth of the tyres on one axle should not vary by more than 2 mm.



The legally permissible minimum tread depth (1.6 mm) has been reached when the tread has worn down as far as one of the tread wear indicators (TWI). Their position is indicated by markings on the sidewall.

Tyres age, even if they are not used. We recommend tyre replacement every 6 years.

Changing tyre and wheel size

If tyres of a different size than those fitted at the factory are used, it may be necessary to reprogramme the

speedometer as well as the nominal tyre pressure and to make other vehicle modifications.

After converting to a different tyre size, have the label with tyre pressures replaced.

⚠ Warning

Use of unsuitable tyres or wheels may lead to accidents and will invalidate the vehicle type approval.

Wheel covers

Wheel covers and tyres that are factory approved for the respective vehicle and comply with all of the relevant wheel and tyre combination requirements must be used.

If the wheel covers and tyres used are not factory approved, the tyres must not have a rim protection ridge.

Wheel covers must not impair brake cooling.

⚠ Warning

Use of unsuitable tyres or wheel covers could lead to sudden pressure loss and thereby accidents.

Tyre chains



Tyre chains are only permitted on the front wheels.

Always use fine mesh chains that add no more than 10 mm to the tyre tread and the inboard sides (including chain lock).

⚠ Warning

Damage may lead to tyre blowout.

Tyre chains are only permitted on tyres of size 165/65 R14.

Tyre chains are not permitted on tyres of size 185/55 R15 and 195/45 R16.

The use of tyre chains is not permitted on the temporary spare wheel.

Tyre repair kit

Minor damage to the tyre tread can be repaired with the tyre repair kit.

Do not remove foreign bodies from the tyres.

Tyre damage exceeding 4 mm or that is at the tyre's sidewall cannot be repaired with the tyre repair kit.

⚠ Warning

Do not drive faster than 80 km/h.

Do not use for a lengthy period.

Steering and handling may be affected.

If you have a flat tyre:
Apply the parking brake and engage first gear or reverse gear.



The tyre repair kit is in the tool box under the floor cover in the load compartment.

1. Open the floor cover.

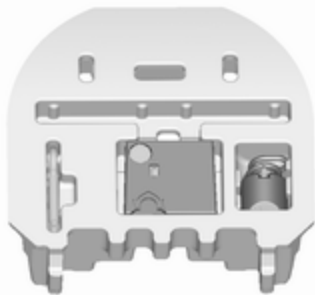

2. Remove the compressor and the sealant bottle.



3. Remove the electrical connection cable and air hose from the storage compartments on the underside of the compressor.



4. Screw the compressor air hose to the connection on the sealant bottle.
5. Fit the sealant bottle into the retainer on the compressor.

Set the compressor near the tyre in such a way that the sealant bottle is upright.

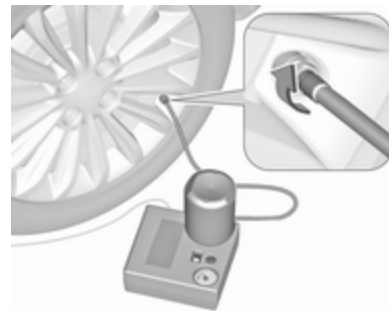

6. Unscrew valve cap from defective tyre.
7. Screw the filler hose to the tyre valve.
8. The switch on the compressor must be set to O.
9. Connect the compressor plug to the power outlet or cigarette lighter socket.

To avoid discharging the battery, we recommend running the engine.

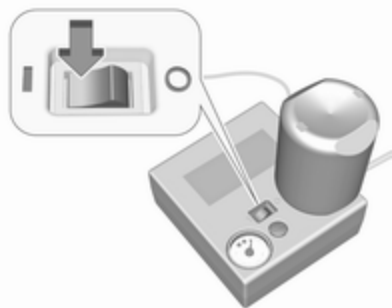

Set the rocker switch on the compressor to I. The tyre is filled with sealant.

10. The compressor pressure gauge briefly indicates up to six bar whilst the sealant bottle is emptying (approx. 30 seconds). Then the pressure starts to drop.
11. All of the sealant is pumped into the tyre. Then the tyre is inflated.
12. The prescribed tyre pressure should be obtained within ten minutes. Tyre pressure ↗ 188. When the correct pressure is obtained, switch off the compressor.



If the prescribed tyre pressure is not obtained within ten minutes, remove the tyre repair kit. Move the vehicle one tyre rotation. Reattach the tyre repair kit and continue the filling procedure for ten minutes. If the prescribed tyre pressure is still not obtained, the tyre is too badly damaged. Seek the assistance of a workshop.

Drain excess tyre pressure with the button over the pressure indicator.

Do not run the compressor for longer than ten minutes.

13. Detach the tyre repair kit. Push catch on bracket to remove sealant bottle from bracket. Screw the tyre inflation hose to the free connection of the sealant bottle. This prevents sealant from escaping. Stow tyre repair kit in load compartment.
14. Remove any excess sealant using a cloth.
15. Take the label indicating maximum permitted speed from the sealant bottle and affix in the driver's field of view.
16. Continue driving immediately so that sealant is evenly distributed in the tyre. After driving approx. 10 km (but no more than ten minutes), stop and check tyre pressure. Screw compressor air hose directly onto tyre valve and compressor when doing this.

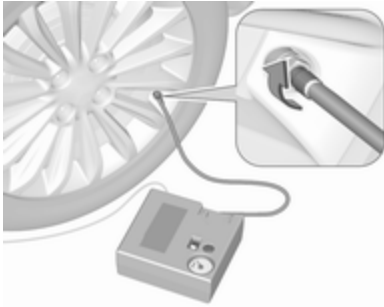

If tyre pressure is more than 1.3 bar, set it to the correct value. Repeat the procedure until there is no more loss of pressure.

If the tyre pressure has fallen below 1.3 bar, the vehicle must not be used. Seek the assistance of a workshop.

17. Stow away tyre repair kit in load compartment.

Reinstall floor cover. Rear floor storage cover ↗ 57.

Note

The driving characteristics of the repaired tyre are severely affected, therefore have this tyre replaced.

If unusual noise is heard or the compressor becomes hot, turn compressor off for at least 30 minutes.

The built-in safety valve opens at a pressure of seven bar.

Note the expiry date of the kit. After this date its sealing capability is no longer guaranteed. Pay attention to storage information on sealant bottle.

Replace the used sealant bottle. Dispose of the bottle as prescribed by applicable laws.

The compressor and sealant can be used from approx. -30 °C.

The adapters supplied can be used to pump up other items e.g. footballs, air mattresses, inflatable dinghies etc. They are located on the underside of the compressor. To remove, screw on compressor air hose and withdraw adapter.

Wheel changing

Some vehicles are equipped with a tyre repair kit instead of a spare wheel.

Make the following preparations and observe the following information:

- Park the vehicle on a level, firm and non-skid surface. The front wheels must be in the straight-ahead position.
- Apply the parking brake and engage first gear or reverse gear.
- Never change more than one wheel at once.
- Use the jack only to change wheels in case of puncture, not for seasonal winter or summer tyre change.
- The jack is maintenance-free.
- If the ground on which the vehicle is standing is soft, a solid board (max. 1 cm thick) should be placed under the jack.
- Take heavy objects out of the vehicle before jacking up.
- No people or animals may be in the vehicle when it is jacked-up.
- Never crawl under a jacked-up vehicle.

- Do not start the vehicle when it is raised on the jack.
- Clean wheel nuts and thread with a clean cloth before mounting the wheel.

⚠ Warning

Do not grease wheel bolt, wheel nut and wheel nut cone.

1. Steel wheels:

Pull off the wheel cover.

Alloy wheels with bolt caps

Disengage wheel bolt caps with a screwdriver and remove. To protect the wheel, place a soft cloth between the screwdriver and the alloy wheel.

Alloy wheels with centre cap

Insert extractor in the open slot of the centre cap and remove the cap from the wheel. Vehicle tools ⇨ 155.

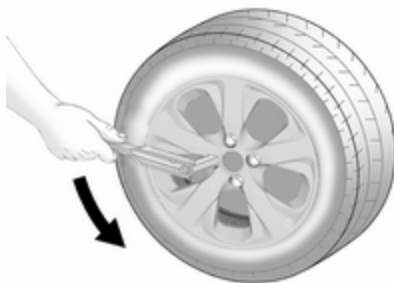

2. Install the wheel wrench ensuring that it locates securely and loosen each wheel bolt by half a turn.

The wheels might be protected by locking wheel bolts. To loosen these specific bolts, first attach the adapter for the locking wheel bolts onto the head of the bolt before installing the wheel wrench. The adapter is located in the glovebox.

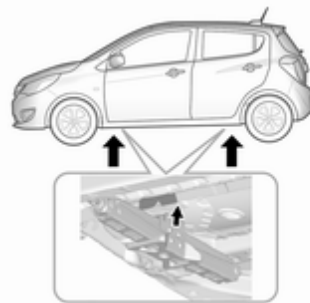

3. Ensure the jack is correctly positioned under the relevant vehicle jacking point.



4. Set the jack to the necessary height. Position it directly below

the jacking point in a manner that prevents it from slipping.

Attach jack handle and with the jack correctly aligned rotate handle until wheel is clear of the ground.

5. Unscrew the wheel bolts.
6. Change the wheel.
7. Screw on the wheel bolts.
8. Lower vehicle.
9. Install the wheel wrench ensuring that it is securely located and tighten each bolt in a crosswise sequence. Tightening torque is 140 Nm.
10. Align the valve hole in the wheel cover of the steel wheel with the tyre valve before installing.
Install wheel bolt caps or centre cap on alloy wheel.
11. Stow and secure the replaced wheel, the vehicle tools ↻ 155 and the adapter for the locking wheel bolts ↻ 53.
12. Check the tyre pressure of the installed tyre and the wheel bolt torque as soon as possible.

Have the defective tyre renewed or repaired as soon as possible.

Jacking position for lifting platform



Rear arm position of the lifting platform, located centrally under the recess of the sill.



Front arm position of the lifting platform at the underbody.

Spare wheel

Some vehicles are equipped with a tyre repair kit instead of a spare wheel.

If mounting a spare wheel, which is different from the other wheels, this wheel might be classified as a temporary spare wheel and the corresponding speed limits apply, even though no label indicates this. Seek the assistance of a workshop to check the applicable speed limit.

The spare wheel has a steel rim.

Caution

The use of a spare wheel that is smaller than the other wheels or in combination with winter tyres could affect driveability. Have the defective tyre replaced as soon as possible.

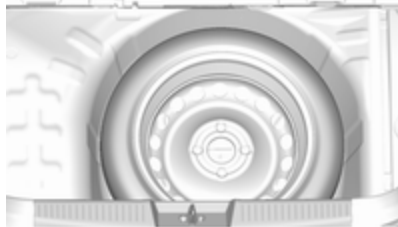

The spare wheel is located in the load compartment beneath the floor covering. It is secured in the recess with a wing bolt.

The spare wheel well is not designed for all permitted tyre sizes. If a wheel wider than the spare must be stowed

in the spare wheel well after changing wheels, the floor cover can be placed on the projecting wheel.

Temporary spare wheel**Caution**

The use of the temporary spare wheel could affect driveability. Have the defective tyre renewed or repaired as soon as possible.

Only mount one temporary spare wheel. Do not drive faster than 80 km/h. Take curves slowly. Do not use for a long period of time.

If your vehicle gets a flat tyre on the rear while towing another vehicle, mount the temporary spare wheel in the front and the full size tyre in the rear.

Tyre chains ⇨ 162.

Storing a damaged wheel in the load compartment using a strap

Use the strap placed in the tool box. Vehicle tools ⇨ 155.

1. Remove load compartment cover and lift up load compartment floor. Position the tool box and the damaged wheel to stand upright into the tool box spare.
2. Pull up the release knob on top of the rear seat and move backrest forwards.

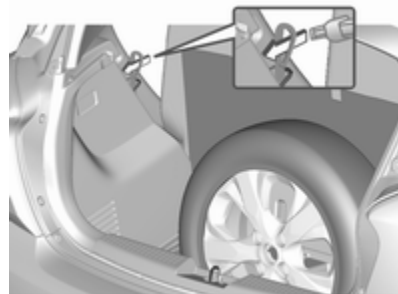

3. Place the loop end of the strap from the tool box through the backrest latch.
4. Place the hook end of the strap through the loop and pull it until the strap is fastened securely to the backrest latch.

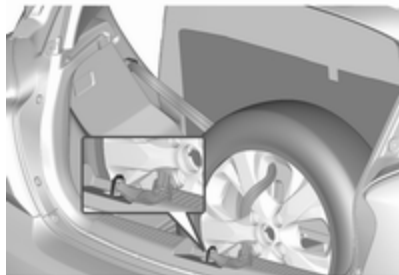

5. Pull back the backrests.
6. Mount the hook to the tailgate latch.
7. Tighten the strap and secure it using the buckle.

⚠ Warning

Storing a jack, a wheel or other equipment in the load compartment could cause injury if they are not fixed properly. During a sudden stop or a collision, loose equipment could strike someone.

Store jack and tools always in the respective storage compartments and secure them by fixing.

Damaged wheel placed in the load compartment must always be secured by the strap.

Jump starting

Do not start with a quick charger.

A vehicle with a discharged vehicle battery can be started using jump leads and the vehicle battery of another vehicle.

⚠ Warning

Be extremely careful when starting with jump leads. Any deviation from the following instructions can lead to injuries or damage caused by battery explosion or damage to the electrical systems of both vehicles.

⚠ Warning

Avoid contact of the battery with eyes, skin, fabrics and painted surfaces. The fluid contains sulphuric acid which can cause injuries and damage in the event of direct contact.

- Never expose the battery to naked flames or sparks.

- A discharged vehicle battery can already freeze at a temperature of 0 °C. Defrost the frozen battery before connecting jump leads.
- Wear eye protection and protective clothing when handling a battery.
- Use a booster battery with the same voltage (12 Volts). Its capacity (Ah) must not be much less than that of the discharged battery.
- Use jump leads with insulated terminals and a cross section of at least 16 mm².
- Do not disconnect the discharged vehicle battery from the vehicle.
- Switch off all unnecessary electrical consumers.
- Do not lean over the battery during jump starting.
- Do not allow the terminals of one lead to touch those of the other lead.
- The vehicles must not come into contact with each other during the jump starting process.

- Apply the parking brake, transmission in neutral.
- Open the positive terminal protection caps of both vehicle batteries.



Lead connection order:

1. Connect the red lead to the positive terminal of the booster battery.
2. Connect the other end of the red lead to the positive terminal of the discharged battery.

3. Connect the black lead to the negative terminal of the booster battery.
4. Connect the other end of the black lead to a vehicle grounding point, such as the engine block or an engine mounting bolt. Connect as far away from the discharged vehicle battery as possible, however at least 60 cm.

Route the leads so that they cannot catch on rotating parts in the engine compartment.

To start the engine:

1. Start the engine of the vehicle providing the jump.
2. After five minutes, start the other engine. Start attempts should be made for no longer than 15 seconds at an interval of one minute.
3. Allow both engines to idle for approx. three minutes with the leads connected.

4. Switch on electrical consumers (e.g. headlights, heated rear window) of the vehicle receiving the jump start.
5. Reverse above sequence exactly when removing leads.

Towing

Towing the vehicle

The towing eye is stowed with the vehicle tools ⇨ 155.



1. Disengage cap by using the screwdriver and remove the cap.



2. Screw in the towing eye as far as it will go until it stops in a horizontal position.
3. Attach a tow rope – or better still a tow rod – to the towing eye.

General

The towing eye must only be used for towing and not for recovering the vehicle.

Switch on ignition to release steering wheel lock and to permit operation of brake lights, horn and windscreen wiper.

Switch the selector lever to neutral.

Release the parking brake.

Caution

Drive slowly. Do not drive jerkily. Excessive tractive force can damage the vehicle.

When the engine is not running, considerably more force is needed to brake and steer.

To prevent the entry of exhaust gases from the towing vehicle, switch on the air recirculation and close the windows.

The vehicle must be towed facing forward, not faster than 88 km/h. In all other cases and when the transmission is defective, the front axle must be raised off the ground.

Seek the assistance of a workshop.

After towing, unscrew the towing eye.

Insert cap and engage in the front bumper.

Appearance care**Exterior care****Locks**

The locks are lubricated at the factory using a high quality lock cylinder grease. Use a de-icing agent only when absolutely necessary, as this has a degreasing effect and impairs lock function. After using a de-icing agent, have the locks regreased by a workshop.

Washing

The paintwork of your vehicle is exposed to environmental influences. Wash and wax your vehicle regularly. When using automatic vehicle washes, select a programme that includes waxing.

Bird droppings, dead insects, resin, pollen and the like should be cleaned off immediately, as they contain aggressive constituents which can cause paint damage.

If using a car wash, comply with the car wash manufacturer's instructions. The windscreen wiper and rear window wiper must be switched off. Remove antenna and external accessories such as roof racks etc.

If you wash your vehicle by hand, make sure that the insides of the wheel housings are also thoroughly rinsed out.

Clean edges and folds on opened doors and the bonnet as well as the areas they cover.

Clean bright metal mouldings with a cleaning solution approved for aluminium to avoid damages.

Caution

Always use a cleaning agent with a pH value of four to nine.

Do not use cleaning agents on hot surfaces.

Have the door hinges of all doors greased by a workshop.

Do not clean the engine compartment with a steam-jet or high-pressure jet cleaner.

Thoroughly rinse and leather-off the vehicle. Rinse leather frequently. Use separate leathers for painted and glass surfaces: remnants of wax on the windows will impair vision.

Do not use hard objects to remove spots of tar. Use tar removal spray on painted surfaces.

Exterior lights

Headlight and other light covers are made of plastic. Do not use any abrasive or caustic agents, do not use an ice scraper, and do not clean them dry.

Polishing and waxing

Wax painted parts of the vehicle regularly (at the latest when water no longer beads). Otherwise, the paintwork will dry out.

Polishing is necessary only if the paint has become dull or if solid deposits have become attached to it.

Paintwork polish with silicone forms a protective film, making waxing unnecessary.

Unpainted plastic body parts must not be treated with wax or polishing agents.

Windows and windscreen wiper blades

Use a soft lint-free cloth or chamois leather together with window cleaner and insect remover.

When cleaning the rear window from inside, always wipe in parallel to the heating element to prevent damage.

For mechanical removal of ice, use a sharp-edged ice scraper. Press the scraper firmly against the glass so that no dirt can get under it and scratch the glass.

Clean smearing wiper blades with a soft cloth and window cleaner.

Sunroof

Never clean with solvents or abrasive agents, fuels, aggressive media (e.g. paint cleaner, acetone-containing solutions etc.), acidic or highly alkaline media or abrasive pads. Do not apply wax or polishing agents to the sunroof.

Wheels and tyres

Do not use high-pressure jet cleaners.

Clean rims with a pH-neutral wheel cleaner.

Rims are painted and can be treated with the same agents as the body.

Paintwork damage

Rectify minor paintwork damage with a touch-up pen before rust forms. Have more extensive damage or rust areas repaired by a workshop.

Underbody

Some areas of the vehicle underbody have a PVC undercoating while other critical areas have a durable protective wax coating.

After the underbody is washed, check the underbody and have it waxed if necessary.

Bitumen/rubber materials could damage the PVC coating. Have underbody work carried out by a workshop.

Before and after winter, wash the underbody and have the protective wax coating checked.

Liquid gas system

⚠ Danger

Liquid gas is heavier than air and can collect in sink points.

Take care when performing work at the underbody in a pit.

For painting work and when using a drying booth at a temperature above 60 °C, the liquid gas tank must be removed.

Do not make any modifications to the liquid gas system.

Interior care

Interior and upholstery

Only clean the vehicle interior, including the instrument panel fascia and panelling, with a dry cloth or interior cleaner.

Clean the leather upholstery with clear water and a soft cloth. In case of heavy soiling, use leather care.

The instrument cluster and the displays should only be cleaned using a soft damp cloth. If necessary use a weak soap solution.

Clean fabric upholstery with a vacuum cleaner and brush. Remove stains with an upholstery cleaner.

Clothing fabrics may not be colourfast. This could cause visible discolourations, especially on light-coloured upholstery. Removable stains and discolourations should be cleaned as soon as possible.

Clean seat belts with lukewarm water or interior cleaner.

Caution

Close Velcro fasteners as open Velcro fasteners on clothing could damage seat upholstery.

The same applies to clothing with sharp-edged objects, like zips or belts or studded jeans.

Plastic and rubber parts

Plastic and rubber parts can be cleaned with the same cleaner as used to clean the body. Use interior cleaner if necessary. Do not use any other agent. Avoid solvents and petrol in particular. Do not use high-pressure jet cleaners.

Service and maintenance

General information	175
Service information	175
Recommended fluids, lubricants and parts	176
Recommended fluids and lubricants	176

General information

Service information

In order to ensure economical and safe vehicle operation and to maintain the value of your vehicle, it is of vital importance that all maintenance work is carried out at the proper intervals as specified.

The detailed, up-to-date service schedule for your vehicle is available at the workshop.

Service display ⇨ 68.

European service intervals

Maintenance of your vehicle is required every 30,000 km or after one year, whichever occurs first, unless otherwise indicated in the service display.

A shorter service interval can be valid for severe driving behaviour, e.g. for taxis and police vehicles.

The European service intervals are valid for the following countries:

Andorra, Austria, Belgium, Bosnia-Herzegovina, Bulgaria, Croatia, Cyprus, Czech Republic, Denmark, Estonia, Finland, France, Germany, Greece, Greenland, Hungary, Iceland, Ireland, Italy, Latvia, Liechtenstein, Lithuania, Luxembourg, Macedonia, Malta, Monaco, Montenegro, Netherlands, Norway, Poland, Portugal, Romania, San Marino, Serbia, Slovakia, Slovenia, Spain, Sweden, Switzerland, United Kingdom.

Service display ⇨ 68.

International service intervals

Maintenance of your vehicle is required every 15,000 km or after one year, whichever occurs first, unless otherwise indicated in the service display.

Severe operating conditions exist if one or more of the following circumstances occur frequently: Cold starting, stop and go operation, trailer operation, mountain driving, driving on poor and sandy road surfaces, increased air pollution, presence of airborne sand and high dust content,

driving at high altitude and large variations of temperature. Under these severe operating conditions, certain service work may be required more frequently than the regular service interval.

The international service intervals are valid for the countries which are not listed in the European service intervals.

Service display ⇨ 68.

Confirmations

Confirmation of service is recorded in the Service and Warranty Booklet. The date and mileage is completed with the stamp and signature of the servicing workshop.

Make sure that the Service and Warranty Booklet is completed correctly as continuous proof of service is essential if any warranty or goodwill claims are to be met, and is also a benefit when selling the vehicle.

Service interval with remaining engine oil life duration

The service interval is based on several parameters depending on usage.

The service display lets you know when to change the engine oil.

Service display ⇨ 68.

Recommended fluids, lubricants and parts

Recommended fluids and lubricants

Only use products that meet the recommended specifications.

Warning

Operating materials are hazardous and could be poisonous. Handle with care. Pay attention to information given on the containers.

Engine oil

Engine oil is identified by its quality and its viscosity. Quality is more important than viscosity when selecting which engine oil to use. The oil quality ensures e.g. engine cleanliness, wear protection and oil aging control, whereas viscosity grade gives information on the oil's thickness over a temperature range.

Dexos is the newest engine oil quality that provides optimum protection for petrol engines. If it is unavailable, engine oils of other listed qualities have to be used. Recommendations for petrol engines are also valid for Liquefied Petroleum Gas (LPG) and Ethanol (E85) fuelled engines.

Select the appropriate engine oil based on its quality and on the minimum ambient temperature ⇨ 181.

Topping up engine oil

Caution
In case of any spilled oil, wipe it up and dispose it properly.

Engine oils of different manufacturers and brands can be mixed as long as they comply with the required engine oil quality and viscosity.

Use of engine oil with only ACEA quality is prohibited, since it can cause engine damage under certain operating conditions.

Select the appropriate engine oil based on its quality and on the minimum ambient temperature ⇨ 181.

Additional engine oil additives

The use of additional engine oil additives could cause damage and invalidate the warranty.

Engine oil viscosity grades

The SAE viscosity grade gives information of the thickness of the oil.

Multigrade oil is indicated by two figures, e.g. SAE 5W-30. The first figure, followed by a W, indicates the low temperature viscosity and the second figure the high temperature viscosity.

Select the appropriate viscosity grade depending on the minimum ambient temperature ⇨ 181.

All of the recommended viscosity grades are suitable for high ambient temperatures.

Coolant and antifreeze

Use only silicate-free long life coolant (LLC) antifreeze approved for the vehicle. Consult a workshop.

The system is factory filled with coolant designed for excellent corrosion protection and frost protection down to approx. -36 °C. In northern countries with very low temperatures the factory filled coolant provides frost protection down to approx. -50 °C. This concentration should be maintained all year round. The use of additional coolant additives that intend to give additional corrosion protection or seal against minor leaks can cause function problems. Liability for consequences resulting from the use of additional coolant additives will be rejected.

Washer fluid

Use only washer fluid approved for the vehicle to prevent damage of wiper blades, paintwork, plastic and rubber parts. Consult a workshop.

Brake and clutch fluid

Over time, brake fluid absorbs moisture which will reduce braking effectiveness. The brake fluid should therefore be replaced at the specified interval.

Technical data

Vehicle identification	179
Vehicle Identification Number ..	179
Identification plate	180
Engine identification	180
Vehicle data	181
Recommended fluids and lubricants	181
Engine data	184
Performance	185
Vehicle weight	185
Vehicle dimensions	186
Capacities	187
Tyre pressures	188

Vehicle identification

Vehicle Identification Number

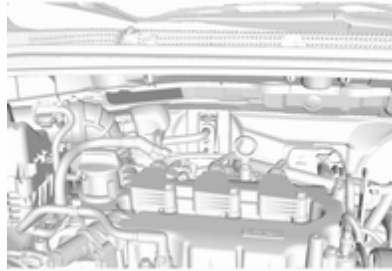

The Vehicle Identification Number is located in the engine compartment.

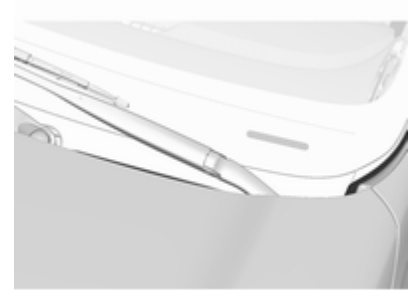

The Vehicle Identification Number may be embossed on the instrument panel, visible through the windscreen.

Identification plate

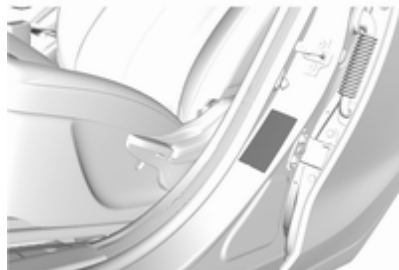

The identification plate is located on the left door frame.

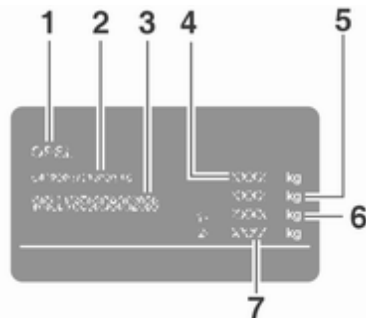

Information on identification label:

- 1 : manufacturer
- 2 : type approval number
- 3 : vehicle identification number
- 4 : permissible gross vehicle weight rating in kg
- 5 : permissible gross train weight in kg
- 6 : maximum permissible front axle load in kg
- 7 : maximum permissible rear axle load in kg

The combined total of front and rear axle loads must not exceed the permissible gross vehicle weight. For example, if the front axle is bearing its maximum permissible load, the rear axle can only bear a load that is equal to the gross vehicle weight minus the front axle load.

The technical data is determined in accordance with European Community standards. We reserve the right to make modifications. Specifications in the vehicle documents always have priority over those given in this manual.

Engine identification

The technical data tables use the engine identifier code. Engine data ⇨ 184.

To identify the respective engine, refer to the EEC Certificate of Conformity provided with your vehicle or other national registration documents.

The Certificate of Conformity shows the engine identifier code, other national publications may show the engineering code. Check piston displacement and engine power to identify the respective engine.

Vehicle data

Recommended fluids and lubricants

European service schedule

Required engine oil quality

All European countries with European service interval ⇨ 175

Engine oil quality

Petrol engines
(including LPG, E85)

dexos2



In case dexos quality is unavailable, you may use max. 1 litre engine oil quality ACEA C3 once between each oil change.

Engine oil viscosity grades

All European countries with European service interval ⇨ 175

Ambient temperature

Petrol engines

down to -25 °C

SAE 0W-30 or SAE 0W-40

SAE 5W-30 or SAE 5W-40

below -25 °C

SAE 0W-30 or SAE 0W-40

International service schedule

Required engine oil quality

All countries with international service interval ⇨ 175

Engine oil quality

Petrol engines
(including LPG, E85)

dexos2



In case dexos quality is unavailable, you may use the oil qualities listed below:

All countries with international service interval ⇨ 175

Engine oil quality

Petrol engines
(including LPG, E85)

ACEA A3/B4



ACEA C3



Engine oil viscosity grades

All countries with international service interval ⇨ 175

Ambient temperature	Petrol engines
down to -25 °C	SAE 0W-30 or SAE 0W-40 SAE 5W-30 or SAE 5W-40
below -25 °C	SAE 0W-30 or SAE 0W-40
down to -20 °C	SAE 10W-30 ¹⁾ or SAE 10W-40

1) Permitted, but usage of SAE 5W-30 or SAE 5W-40 with dexos quality is recommended.

Engine data

Engine identifier code	B10XE	B10XL LPG
Sales designation	1.0	1.0 LPG
Piston displacement [cm ³]	999	999
Engine power [kW]	55	54
at rpm	6500	6500
Torque [Nm]	95	92
at rpm	4500	4500
Fuel type	Petrol	Liquid gas/Petrol
Octane rating RON ²⁾		
recommended	95	95
possible	91	91
possible	98	98
Additional fuel type	–	Liquid gas (LPG)

2) A country-specific label at the fuel filler flap can supersede the engine specific requirement.

Performance

Engine	B10XE	B10XL LPG
Maximum speed [km/h]		
Manual transmission	170	170
Manual transmission automated	170	–
Automatic transmission	–	–

Vehicle weight

Kerb weight

	Engine	Manual transmission	Manual transmission automated	Automatic transmission
minimum / maximum [kg]	B10XE	939 / 1034	939/1034	–
	B10XL LPG	1025/1091	–	–

Optional accessories increase the kerb weight.

Loading information ↗ 59.

Vehicle dimensions

Length [mm]	3675
Width without exterior mirrors [mm]	1595-1632 ³⁾
Width with two exterior mirrors [mm]	1876
Height (without antenna) [mm] without roof rack	1476-1495 ³⁾
Length of load compartment floor [mm]	486
Length of load compartment with folded rear seats [mm]	1109
Load compartment width [mm]	968
Load compartment height with cover [mm]	499
Height of load compartment opening [mm]	608
Wheelbase [mm]	2385
Turning circle diameter [m] ³⁾	9.8 - 10.7

3) Depending on equipment variants.

Capacities

Engine oil

Engine

B10XE
B10XL LPG

including Filter [l]

3.5

between MIN and MAX [l]

1.0

Fuel tank

Engine

B10XE

B10XL LPG

Petrol, refilling quantity [l]

32

32

LPG, refilling quantity [l]

–

20

Tyre pressures

Engine	Tyres	Comfort with up to 3 people		ECO with up to 3 people		With full load	
		front	rear	front	rear	front	rear
		[kPa/bar] ([psi])	[kPa/bar] ([psi])	[kPa/bar] ([psi])	[kPa/bar] ([psi])	[kPa/bar] ([psi])	[kPa/bar] ([psi])
B10XE,	165/65 R14,	220/2.2 (32)	210/2.1 (30)	270/2.7 (39)	250/2.5 (36)	260/2.6 (38)	300/3.0 (44)
B10XL LPG	185/55 R15, 195/45 R16						
	Temporary spare wheel	420/4.2 (60)					
	T105/70D14						

Customer information

Customer information	189
Declaration of conformity	189
REACH	192
Collision damage repair	192
Software acknowledgement	192
Registered trademarks	194
Vehicle data recording and privacy	195
Event data recorders	195
Radio Frequency Identification (RFID)	195

Customer information

Declaration of conformity

Radio transmission systems

This vehicle has systems that transmit and / or receive radio waves subject to Directive 1999/5/EC or 2014/53/EU. The manufacturers of the systems listed below declare conformity with Directive 1999/5/EC or 2014/53/EU. The full text of the EU declaration of conformity for each system is available at the following internet address: www.opel.com/conformity

Importer is

Opel / Vauxhall, Bahnhofplatz,
65423 Ruesselsheim am Main,
Germany.

Antenna

INFAC ELECS

Saneop-ro 155beon-gi Gwonseon-gu,
Suwon city, Gyeonggi-do, Korea

Operation frequency: N/A

Maximum output: N/A

Immobiliser

Robert Bosch GmbH

Robert Bosch Platz 1, 70839
Gerlingen, Germany

Operation frequency: 125 kHz

Maximum output:

5.1 dB μ A/m @ 10 m

Infotainment system R 4.0 / Navi 4.0

LGE

LG Electronics European Shared
Service Center B.V., Krijgsman 1,
1186 DM Amstelveen, The
Netherlands

Operation frequency (MHz)	Maximum output (dBm)
---------------------------	----------------------

2400.0 - 2483.5	4
-----------------	---

2402.0 - 2480.0	4
-----------------	---

2400.0 - 2483.5	13
-----------------	----

5725.0 - 5850.0	13
-----------------	----

Infotainment system R300 BT

Humax Automotive Co. Ltd.

2, Yeongmun-ro, Cheoin-gu, Yong-in-si, Gyeonggi-do, Korea

Operation frequency:

2402 - 2480 MHz

Maximum output: 4 dBm EIRP

OnStar module

LGE

LG Electronics European Shared
Service Center B.V., Krijgsman 1,
1186 DM Amstelveen, The
Netherlands

Operation frequency (MHz)	Maximum output (dBm)
---------------------------	----------------------

2402 - 2480	4
-------------	---

2412 - 2462	18
-------------	----

880 - 915	33
-----------	----

1710 - 1785	24
-------------	----

1850 - 1910	24
-------------	----

1920 - 1980	24
-------------	----

2500 - 2570	23
-------------	----

Radio remote control transmitter

Continental Automotive GmbH

Siemensstraße 12, 93055
Regensburg, Germany

Operation frequency: 433.92 MHz

Maximum output: -5.7 dbm

Robert Bosch GmbH

Robert Bosch Platz 1, 70839
Gerlingen, Germany

Operation frequency: 433.92 MHz

Maximum output: -4 dbm

Radio remote control receiver

Robert Bosch GmbH

Robert Bosch Platz 1, 70839
Gerlingen, Germany

Operation frequency: 433.92 MHz

Maximum output: N/A

Tyre pressure sensors

Schrader Electronics Ltd.

11 Technology Park, Belfast Road,
Antrim BT41 1QS, Northern Ireland,
United Kingdom

Operation frequency: 433.92 MHz

Maximum output: 10 dBm

Jack



GM Korea

GM Korea Company
12A-2, Chaejeon-ro, Seong
Yang-si, Incheon, 400-750, Korea**Declaration of Conformity**

pursuant to Directive 2006/42/EC

We hereby declare that the product:

Product description: Car Jack**Type/Part No.** : 13584087

is in conformity with Directive 2006/42/EC.

Technical standards applied:

GMW14337 Standard Equipment Jack - Hardware Tests

GMW15005 Standard Equipment Jack and Spare Tire, Vehicle Test

The person authorized to compile the technical file is:

Hans-Peter Metzger
Adam Opel AG
65423 Rüsselsheim / Germany

Incheon, Republic of Korea, 2 February 2015

Daehyeok An
Engineering Group Manager Tire Wheel Systems
GM Korea

Translation of the original declaration of conformity

Declaration of conformity according to EC Directive 2006/42/EC

We declare that the product:

Product designation: Jack

Type/GM part number: 13584087

is in compliance with the provisions of Directive 2006/42/EC.

Applied technical standards:

GM 14337 : standard equipment jack – hardware tests

GMW15005 : standard equipment jack and spare tyre, vehicle test

The person authorised to compile the technical documentation is

Hans-Peter Metzger

Engineering Group Manager Chassis & Structure

Adam Opel AG

D-65423 Rüsselsheim

Signed by
Daehyeok An

Engineering Group Manager Tyre Wheel Systems

GM Korea

Bupyung, Incheon, 403-714, Korea
Incheon, Republic of Korea, 4th April 2014

REACH

Registration, Evaluation, Authorisation and Restriction of Chemicals (REACH) is a European Union regulation adopted to improve the protection of human health and the environment from the risks that can be posed by chemicals. Visit www.opel.com/reach for further information and for access to the Article 33 communication.

Collision damage repair

Paint thickness

Due to production techniques, the thickness of the paint can vary between 50 and 400 µm.

Therefore, different paint thickness is no indicator for a collision damage repair.

Software acknowledgement

Certain OnStar components include libcurl and unzip software and other third party software. Below are the notices and licenses associated with libcurl and unzip and for other third party software please see <http://www.lg.com/global/support/opensource/index>.

libcurl

Copyright and permission notice
Copyright (c) 1996 - 2010, Daniel Stenberg, <daniel@haxx.se>.

All rights reserved.

Permission to use, copy, modify, and distribute this software for any purpose with or without fee is hereby granted, provided that the above copyright notice and this permission notice appear in all copies.

The software is provided "as is", without warranty of any kind, express or implied, including but not limited to

the warranties of merchantability, fitness for a particular purpose and noninfringement of third party rights. In no event shall the authors or copyright holders be liable for any claim, damages or other liability, whether in an action of contract, tort or otherwise, arising from, out of or in connection with the software or the use or other dealings in the software. Except as contained in this notice, the name of a copyright holder shall not be used in advertising or otherwise to promote the sale, use or other dealings in this Software without prior written authorization of the copyright holder.

unzip

This is version 2005-Feb-10 of the Info-ZIP copyright and license. The definitive version of this document should be available at <ftp://ftp.info-zip.org/pub/infozip/license.html> indefinitely.

Copyright (c) 1990-2005 Info-ZIP. All rights reserved.

For the purposes of this copyright and license, "Info-ZIP" is defined as the following set of individuals:

Mark Adler, John Bush, Karl Davis, Harald Denker, Jean-Michel Dubois, Jean-loup Gailly, Hunter Goatley, Ed Gordon, Ian Gorman, Chris Herborth, Dirk Haase, Greg Hartwig, Robert Heath, Jonathan Hudson, Paul Kienitz, David Kirschbaum, Johnny Lee, Onno van der Linden, Igor Mandrichenko, Steve P. Miller, Sergio Monesi, Keith Owens, George Petrov, Greg Roelofs, Kai Uwe Rommel, Steve Salisbury, Dave Smith, Steven M. Schweda, Christian Spieler, Cosmin Truta, Antoine Verheijen, Paul von Behren, Rich Wales, Mike White.

This software is provided "as is," without warranty of any kind, express or implied. In no event shall Info-ZIP or its contributors be held liable for any direct, indirect, incidental, special or consequential damages arising out of the use of or inability to use this software.

Permission is granted to anyone to use this software for any purpose, including commercial applications, and to alter it and redistribute it freely, subject to the following restrictions:

1. Redistributions of source code must retain the above copyright notice, definition, disclaimer, and this list of conditions.
2. Redistributions in binary form (compiled executables) must reproduce the above copyright notice, definition, disclaimer, and this list of conditions in documentation and/or other materials provided with the distribution. The sole exception to this condition is redistribution of a standard UnZipSFX binary (including SFXWiz) as part of a self-extracting archive; that is permitted without inclusion of this license, as long as the normal SFX banner has not been removed from the binary or disabled.

3. Altered versions—including, but not limited to, ports to new operating systems, existing ports with new graphical interfaces, and dynamic, shared, or static library versions—must be plainly marked as such and must not be misrepresented as being the original source. Such altered versions also must not be misrepresented as being Info-ZIP releases—including, but not limited to, labeling of the altered versions with the names “Info-ZIP” (or any variation thereof, including, but not limited to, different capitalizations), “Pocket UnZip,” “WiZ” or “MacZip” without the explicit permission of Info-ZIP. Such altered versions are further prohibited from misrepresentative use of the Zip-Bugs or Info-ZIP e-mail addresses or of the Info-ZIP URL(s).
4. Info-ZIP retains the right to use the names “Info-ZIP,” “Zip,” “UnZip,” “UnZipSFX,” “WiZ,” “Pocket UnZip,” “Pocket Zip,” and “MacZip” for its own source and binary releases.

Registered trademarks

Apple Inc.

Apple CarPlay™ is a trademark of Apple Inc.

App Store® and iTunes Store® are registered trademarks of Apple Inc.

iPhone®, iPod®, iPod touch®, iPod nano®, iPad® and Siri® are registered trademarks of Apple Inc.

Bluetooth SIG, Inc.

Bluetooth® is a registered trademark of Bluetooth SIG, Inc.

DivX, LLC

DivX® and DivX Certified® are registered trademarks of DivX, LLC.

EnGIS Technologies, Inc.

BringGo® is a registered trademark of EnGIS Technologies, Inc.

Google Inc.

Android™ and Google Play™ Store are trademarks of Google Inc.

Stitcher Inc.

Stitcher™ is a trademark of Stitcher, Inc.

Verband der Automobilindustrie e.V.
AdBlue® is a registered trademark of the VDA.

Vehicle data recording and privacy

Event data recorders

Data storage modules in the vehicle

A large number of electronic components of your vehicle contain data storage modules temporarily or permanently storing technical data about the condition of the vehicle, events and errors. In general, this technical information documents the condition of parts, modules, systems or the environment:

- Operating conditions of system components (e.g. filling levels).
- Status messages of the vehicle and its single components (e.g. number of wheel revolutions / rotational speed, deceleration, lateral acceleration).
- Dysfunctions and defects in important system components.

- Vehicle reactions in particular driving situations (e.g. inflation of an airbag, activation of the stability regulation system).
- Environmental conditions (e.g. temperature).

These data are exclusively technical and help identifying and correcting errors as well as optimizing vehicle functions.

Motion profiles indicating travelled routes cannot be created with these data.

If services are used (e.g. repair works, service processes, warranty cases, quality assurance), employees of the service network (manufacturer included) are able to read out this technical information from the event and error data storage modules applying special diagnostic devices. If required, you will receive further information at these workshops. After an error has been corrected, the data are deleted from the error storage module or they are constantly overwritten.

When using the vehicle, situations may occur in which these technical data related to other information (accident report, damages on the vehicle, witness statements etc.) may be associated with a specific person - possibly, with the assistance of an expert.

Additional functions contractually agreed upon with the client (e.g. vehicle location in emergency cases) allow the transmission of particular vehicle data from the vehicle.

Radio Frequency Identification (RFID)

RFID technology is used in some vehicles for functions such as tyre pressure monitoring and ignition system security. It is also used in connection with conveniences such as radio remote controls for door locking/unlocking and starting, and in-vehicle transmitters for garage door openers. RFID technology in Opel vehicles does not use or record personal information or link with any other Opel system containing personal information.

Index

A

Accessories and vehicle modifications	137
Adjustable air vents	105
Airbag and belt tensioners	72
Airbag deactivation	46, 72
Airbag label.....	41
Airbag system	41
Air conditioning regular operation	106
Air conditioning system	100
Air intake	106
Air vents.....	105
Antilock brake system	119
Antilock brake system (ABS)	74
Anti-theft alarm system	27
Appearance care.....	172
Ashtrays	65
Autostop.....	111

B

Battery discharge protection	98
Battery voltage	85
Belts.....	39
Bonnet	139
Bonnet open.....	76
Brake and clutch fluid.....	176
Brake and clutch system	73
Brake assist	120
Brake fluid	142

Brakes	119, 142
Breakdown.....	171
Bulb replacement	144

C

Capacities	187
Catalytic converter	115
Central locking system	23
Centre console storage	54
Centre high-mounted brake light	149
Changing tyre and wheel size ...	161
Charging system	73
Child locks	25
Child restraint installation locations	50
Child restraints.....	47
Child restraint systems	47
Cigarette lighter	65
City mode.....	123
Climate control	17
Climate control systems.....	99
Clock	63
Code.....	83
Collision damage repair.....	192
Control indicators.....	69
Control of the vehicle	108
Controls.....	61
Coolant and antifreeze.....	176
Cornering lights.....	94
Cruise control	76, 124

Cupholders 53
 Curtain airbag system 45

D

Danger, Warnings and Cautions ... 4
 Daytime running lights 94
 Declaration of conformity..... 189
 Door open 77
 Doors..... 26
 Driver assistance systems..... 124
 Driver Information Centre..... 77
 Driving hints..... 108

E

Electric adjustment 29
 Electrical system..... 150
 Electronic climate control system 102
 Electronic driving programmes .. 118
 Electronic Stability Control..... 122
 Electronic Stability Control and
 Traction Control system..... 74
 Electronic Stability Control off..... 74
 End-of-life vehicle recovery 138
 Engine compartment fuse box ... 152
 Engine coolant 141
 Engine coolant temperature 75
 Engine coolant temperature
 gauge 68
 Engine data 184
 Engine exhaust 115
 Engine identification..... 180

Engine oil 140, 176, 181
 Engine oil pressure 75
 Event data recorders..... 195
 Exit lighting 97
 Exterior care 172
 Exterior light 76
 Exterior lighting 14, 93
 Exterior mirrors..... 29

F

Fault 118
 First aid..... 58
 First aid kit 58
 Fixed air vents 106
 Fog light 76
 Fog lights 146
 Folding mirrors 29
 Front airbag system 44
 Front doors..... 25
 Front fog lights 95
 Front seats..... 36
 Front turn signal lights 147
 Fuel..... 129
 Fuel consumption - CO₂-
 Emissions 136
 Fuel for liquid gas operation..... 130
 Fuel for petrol engines 129
 Fuel gauge 66
 Fuel selector 67
 Fuses 150

G

Gauges..... 65
 Gear shifting..... 74
 Glovebox 53

H

Halogen headlights 145
 Hand brake..... 119, 120
 Hazard warning flashers 94
 Headlight flash 93
 Headlight range adjustment 94
 Headlights..... 93
 Headlights when driving abroad .. 94
 Head restraint adjustment 8
 Head restraints 35
 Heated mirrors 29
 Heated rear window 32
 Heated steering wheel 61
 Heating 38
 Heating and ventilation system ... 99
 High beam 76, 93
 Hill start assist 120
 Horn 15, 62

I

Identification plate 180
 Ignition switch positions 109
 Immobiliser 28, 76
 Indicators..... 65
 Info display..... 82
 Information displays..... 77

- Instrument cluster 65
Instrument panel fuse box 153
Instrument panel illumination 150
Instrument panel illumination
control 96
Instrument panel overview 10
Interior care 174
Interior lighting 96
Interior lights 97, 150
Interior mirrors 30
Introduction 3
- J**
Jump starting 169
- K**
Key, memorised settings 23
Keys 21
Keys, locks 21
- L**
Lane departure warning 74, 128
Light switch 93
Load compartment 26, 54
Load compartment cover 56
Loading information 59
Low fuel 76
- M**
Malfunction indicator light 73
Manual adjustment 29
- Manual anti-dazzle 30
Manual mode 118
Manual transmission 115
Manual transmission automated 116
Manual windows 31
Memorised settings 23
Mirror adjustment 8
Mirrors 29
Misted light covers 96
- N**
New vehicle running-in 109
Number plate light 149
- O**
Object detection systems 127
Odometer 66
Oil, engine 176, 181
OnStar 88
Operate pedal 73
Outside temperature 63
Overrun cut-off 111
- P**
Parking 20, 114
Parking assist 127
Parking brake 120
Parking lights 96
Performance 185
Performing work 139
Pollen filter 106
- Power outlets 65
Power steering 74
Power windows 31
Puncture 165
- R**
Radio Frequency Identification
(RFID) 195
Radio remote control 22
REACH 192
Reading lights 97
Rear doors 26
Rear floor storage cover 57
Rear fog light 76, 95
Rear window wiper/washer 63
Recommended fluids and
lubricants 176, 181
Reduced engine power 76
Refuelling 132
Registered trademarks 194
Retained power off 110
Reversing lights 96
Ride control systems 121
Roof 33
Roof load 59
Roof rack 58
- S**
Safety belts 39
Seat adjustment 7, 37
Seat belt 8

Seat belt reminder	72
Seat belts	39
Seat heating.....	38
Seat position	36
Selector lever	117
Service	107
Service display	68
Service information	175
Service vehicle soon	73
Side airbag system	45
Sidelights.....	93
Side turn signal lights	148
Software acknowledgement.....	192
Spare wheel	167
Speed limiter.....	76, 125
Speedometer	65
Starting and operating.....	109
Starting off	18
Starting the engine	110, 116
Steering.....	109
Steering wheel adjustment	9, 61
Steering wheel controls	61
Stop-start system.....	111
Storage.....	53
Storage compartments.....	53
Sunroof	33
Sun visors	33
Symbols	4

T

Tachometer	66
Tail lights	147
Three-point seat belt	40
Tools	155
Towing.....	171
Towing the vehicle	171
Traction Control system	121
Traction Control system off.....	75
Transmission	17
Transmission display	116
Tread depth	161
Trip odometer	66
Turn and lane-change signals	95
Turn signal	71
Tyre chains	162
Tyre designations	156
Tyre pressure	156
Tyre pressure monitoring system.....	75, 157
Tyre pressures	188
Tyre repair kit	162

U

Ultrasonic parking assist	74, 127
Upholstery.....	174
Using this manual	3

V

Valet mode.....	82
Vehicle battery	142

Vehicle checks.....	139
Vehicle data.....	181
Vehicle data recording and privacy.....	195
Vehicle dimensions	186
Vehicle Identification Number	179
Vehicle jack.....	155
Vehicle messages	83
Vehicle personalisation	86
Vehicle specific data	3
Vehicle storage.....	138
Vehicle tools.....	155
Vehicle unlocking	6
Vehicle weight	185
Ventilation.....	99

W

Warning chimes	85
Warning lights.....	65
Warning triangle	57
Washer and wiper systems	15
Washer fluid	141
Wheel changing	165
Wheel covers	161
Wheels and tyres	156
Windows.....	30
Windscreen.....	30
Windscreen wiper/washer	62
Winter tyres	156
Wiper blade replacement	144

www.opel.com

Copyright by ADAM OPEL GmbH, Rüsselsheim, Germany.

The information contained in this publication is effective as of the date indicated below. Adam Opel GmbH reserves the right to make changes to the technical specifications, features and design of the vehicles relative to the information in this publication as well as changes to the publication itself.

Edition: June 2017, ADAM OPEL GmbH, Rüsselsheim.

Printed on chlorine-free bleached paper.

ID-OKAAOBSE1706-en

