

OPEL VIVARO / MOVANO

Infotainment Manual



Contents

Introduction	4
Radio	45
CD Player	55
AUX input	59
USB port	61
Bluetooth music	65
External devices	72
Navigation	74
Voice recognition	118
Phone	122
Index	142

Introduction

General information	4
Control elements overview	6
Theft-deterrent feature	23
Usage	24
Tone settings	36
Volume settings	39
System settings	40

General information

The Infotainment system provides state-of-the-art in-car information and entertainment.

The radio is equipped with assignable channel presets for FM, AM and DAB wavebands.

The audio player plays audio CDs, MP3 CDs and also WMA CDs.

External data storage devices, e.g. iPod, MP3 player or USB stick, or a portable player can be connected to the Infotainment system. External audio sources can also be connected via Bluetooth.

The digital sound processor provides several preset equalizer modes for sound optimisation.

The navigation system's dynamic route planning will reliably guide you to your destination and can help avoid traffic jams and other traffic problems.

Optionally, the Infotainment system can be operated using controls on the steering column or via the voice recognition system.

In addition, the Infotainment system can be equipped with a handsfree phone system.

The well-thought-out design of the controls and the clear displays enable you to control the system easily and intuitively.

Note

This manual describes all options and features available for the various Infotainment systems. Certain descriptions, including those for display and menu functions, may not apply to your vehicle due to model variant, country specifications, special equipment or accessories.

Important information on operation and traffic safety

Warning

Drive safely at all times when using the Infotainment system.

If in doubt, stop the vehicle before operating the Infotainment system.

Radio reception

Radio reception may be disrupted by static, noise, distortion or loss of reception due to:

- changes in distance from the transmitter
- multi-path reception due to reflection
- shadowing

In case of poor radio reception the volume will automatically drop as to minimize the disturbance effect.

Using this manual

- This manual describes features that may or may not be on your specific vehicle, either because they are optional or due to changes subsequent to the printing of this manual. Please refer to the purchase documentation to confirm each of the features found on the vehicle.
- Certain controls and descriptions, including symbols, displays and menu functions may not apply to your vehicle due to

model variant, country specifications, special equipment or accessories.

- The table of contents at the beginning of this manual and within each section shows where the information is located.
- The index will enable you to search for specific information.
- The vehicle display screens may not support your specific language.
- Display messages and interior labelling are written in **bold** letters.
- The operations given within this manual refer to Infotainment system controls. For equivalent steering column controls, refer to the control elements overview ⇨ 6.

Warnings and cautions

Warning

Text marked  **Warning** provides information on risk of accident or injury. Disregarding this information may lead to injury.

Caution

Text marked **Caution** provides information on possible damage to the vehicle. Disregarding this information may lead to vehicle damage.





Symbols

Page references are indicated with ⇨.
⇨ means "see page".

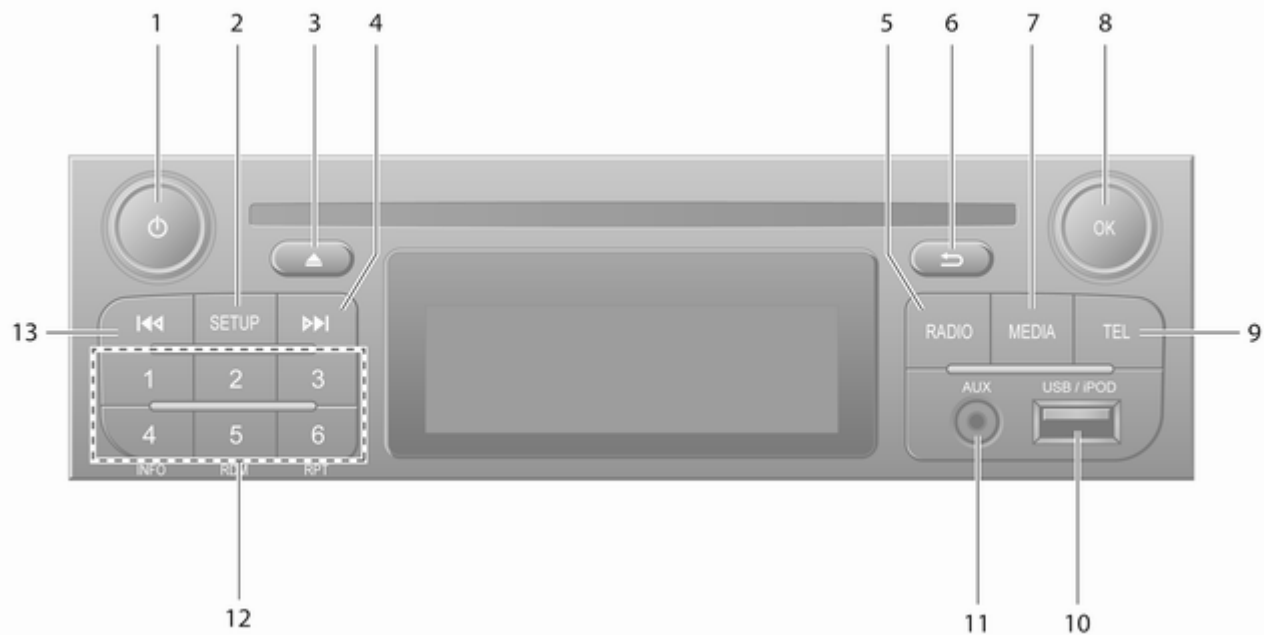
Control elements overview

R15 BT USB



- | | |
|--|---|
| <p>1  - Press: Switch on/off 24</p> <p>Press: Mute/unmute 24</p> <p>Turn: Adjust volume 24</p> <p>2 SETUP - Short press:</p> <p>Settings menu 24</p> <p>Display radio text
information 51</p> <p>Long press: Automatic
station storing 50</p> <p>3 Mute/unmute 24</p> <p>4  - Radio, Short press:</p> <p>Search for next radio
frequency 47</p> <p>Long press: Automatic
station search 47</p> <p>5 RADIO - Change audio
source, waveband 45</p> <p>6  - Return to previous
menu, cancel an action 24</p> <p>7 MEDIA - Change audio
source 56</p> <p>8 OK rotary knob 24</p> <p>Press: Confirm an action 24</p> | <p>Turn: Access display
menu options 24</p> <p>Turn: Change radio
frequency 47</p> <p>9 TEL - Telephone menu 122</p> <p>10 USB port 61</p> <p>11 AUX input 59</p> <p>12 Station buttons 1..6 47</p> <p>Short press: Select station 47</p> <p>Long press: Save station 47</p> <p>13  - Radio, Short press:</p> <p>Search for previous radio
frequency 47</p> <p>Long press: Automatic
station search 47</p> |
|--|---|

R16 BT USB

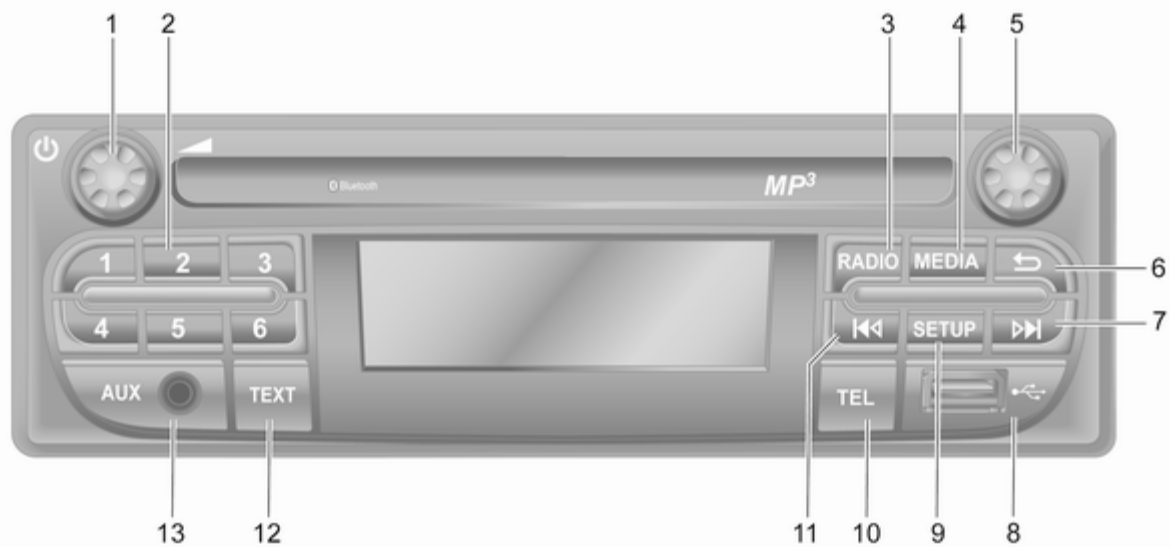

- | | |
|----|--|
| 1 | ⏻ - Press: Switch on/off 24
Turn: Adjust volume 24 |
| 2 | Station buttons 1...6 47
Short press: Select station 47
Long press: Save station 47 |
| 3 | RADIO - Change audio source, waveband 45 |
| 4 | MEDIA - Change audio source 56 |
| 5 | Rotary knob 24

Short press: Confirm an action 24

Turn: Access display menu options 24 |
| 6 | ↶ - Return to previous menu, cancel an action 24 |
| 7 | ▶▶ - Radio, Short press: Search for next radio frequency 47



Long press: Automatic station search 47 |
| | Audio/MP3/WMA CD, Short press: Skip track forwards 56

Long press: Fast forward 56 |
| 8 | USB port 61 |
| 9 | SETUP - Short press: Settings menu 24 |
| 10 | TEL - Telephone menu 122 |
| 11 | ◀◀ - Radio, Short press: Search for previous radio frequency 47

Long press: Automatic station search 47 |
| 12 | TEXT - Display radio text information 51 |
| 13 | AUX input 59 |

CD16 BT USB





- | | |
|--|---|
| <p>1  - Press: Switch on/off 24
Turn: Adjust volume 24</p> <p>2 SETUP - Short press:
Settings menu 24</p> <p>3  - Radio, Short press:
Search for next radio
frequency 47

Long press: Automatic
station search 47

Audio/MP3/WMA CD,
Short press: Skip track
forwards 56

Long press: Fast forward 56</p> <p>4 RADIO - Change audio
source, waveband 45</p> <p>5 MEDIA - Change audio
source 56</p> <p>6 Rotary knob 24

Short press: Confirm an
action 24

Turn: Access display
menu options 24</p> <p>7 TEL - Telephone menu 122</p> | <p>8 Station buttons 1...6 47
Short press: Select station 47
Long press: Save station 47</p> <p>9 USB port 61</p> <p>10  - Return to previous
menu, cancel an action 24</p> <p>11  - CD ejection 56</p> <p>12 AUX input 59</p> <p>13  - Radio, Short press:
Search for previous radio
frequency 47

Long press: Automatic
station search 47

Audio/MP3/WMA CD,
Short press: Skip track
backwards 56

Long press: Fast rewind 56</p> |
|--|---|



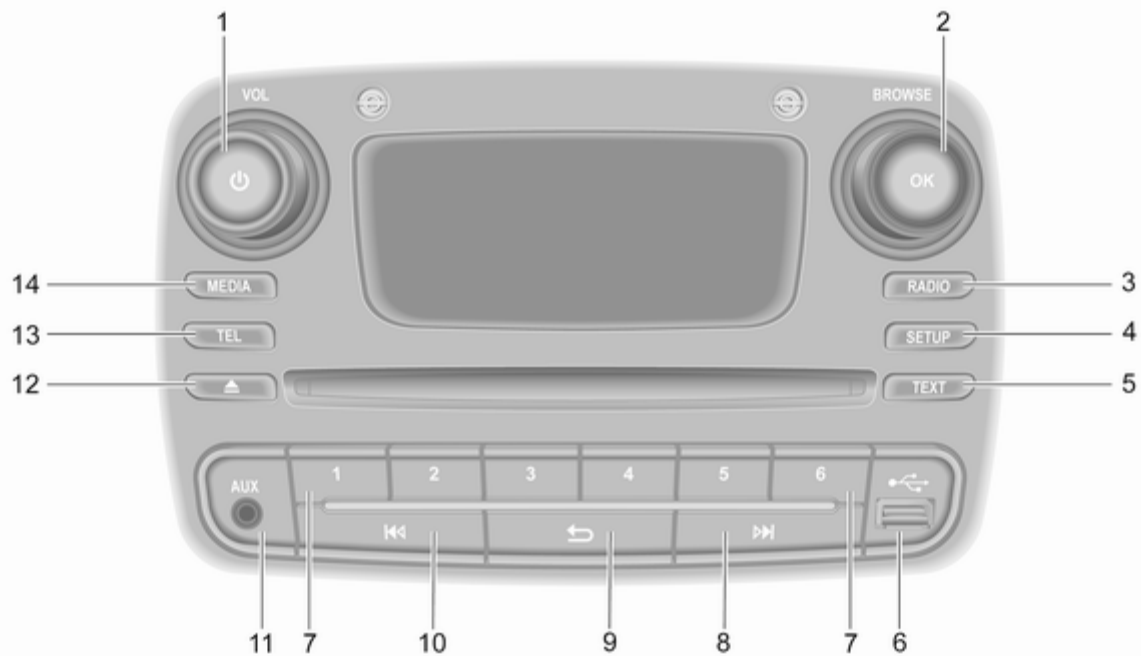

CD18 BT USB

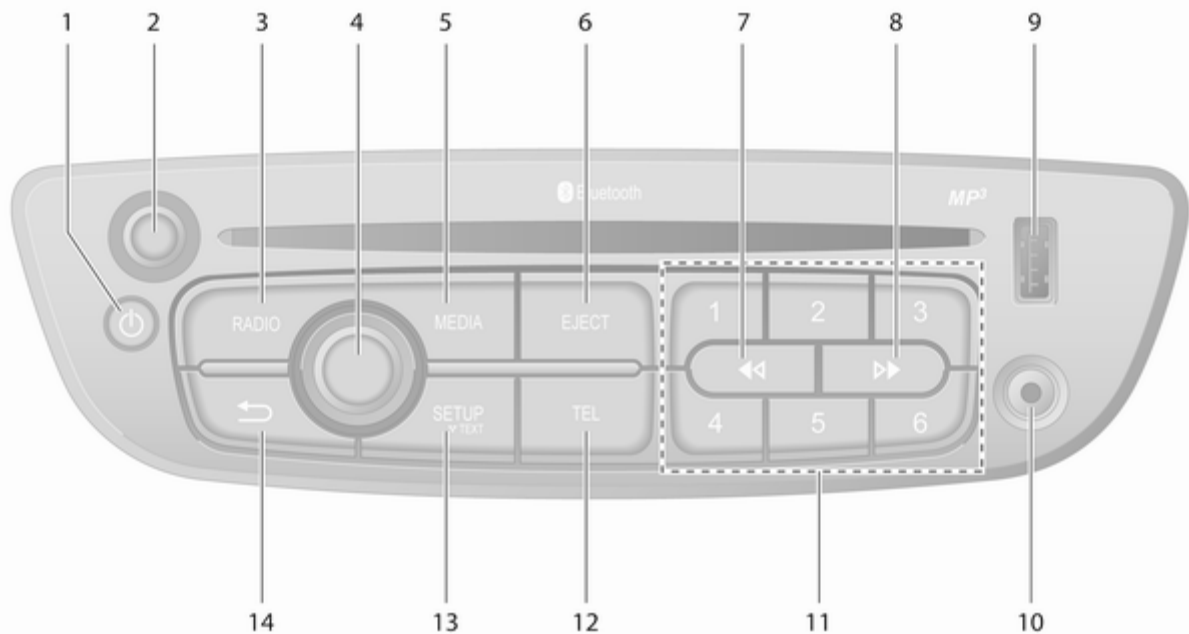

- | | | |
|---|---|---|
| 1 | ⏻ - Press: Switch on/off 24
Turn: Adjust volume 24 | Audio/MP3/WMA CD,
Short press: Skip track
forwards 56 |
| 2 | OK rotary knob 24
Short press: Confirm an
action 24
Turn: Access display
menu options 24 | Long press: Fast forward 56 |
| 3 | RADIO - Change audio
source, waveband 45 | 9 → - Return to previous
menu, cancel an action 24 |
| 4 | SETUP - Short press:
Settings menu 24 | 10 ⏮ - Radio, Short press:
Search for previous radio
frequency 47 |
| 5 | TEXT - Display radio text
information 51 | Long press: Automatic
station search 47 |
| 6 | USB port 61 | Audio/MP3/WMA CD,
Short press: Skip track
backwards 56 |
| 7 | Station buttons 1...6 47
Short press: Select station 47
Long press: Save station 47 | Long press: Fast rewind 56 |
| 8 | ▶▶ - Radio, Short press:
Search for next radio
frequency 47
Long press: Automatic
station search 47 | 11 AUX input 59 |
| | | 12 △ - CD ejection 56 |
| | | 13 TEL - Telephone menu 122 |
| | | 14 MEDIA - Change audio
source 56 |

CD35 BT USB / CD35 BT USB NAVI



- | | | |
|--|--|---|
| <p>1  - Press: Switch on/off 24</p> <p>2 Volume rotary knob -
Press: Mute/unmute 24
Turn: Adjust volume 24</p> <p>3 RADIO - Change audio
source, waveband 45</p> <p>4 Central rotary knob 24
Press: Confirm an action 24
Turn: Access display
menu options 24
Turn: Access the stored
radio station list 45
Turn: Select next/previous
station 47
Turn: Change CD/MP3
track 56</p> <p>5 MEDIA - Change audio
source 56</p> <p>6 EJECT - CD ejection 56</p> <p>7  - Radio, Short press:
Search for previous radio
frequency 47
Long press: Automatic
station search 47</p> | <p>Audio/MP3/WMA CD,
Short press: Skip track
backwards 56
Long press: Fast rewind 56</p> <p>8  - Radio, Short press:
Search for next radio
frequency 47
Long press: Automatic
station search 47
Audio/MP3 CD, Short
press: Skip track forwards 56
Long press: Fast forward 56</p> <p>9 USB port 61</p> <p>10 AUX input 59</p> <p>11 Station buttons 1...6 47
Short press: Select station 47
Long press: Save station 47</p> <p>12 TEL - Telephone menu 122</p> | <p>13 SETUP / TEXT - Short
press: Settings menu 24
Long press: Display radio
text information 51
Long press: Display CD
text information 56</p> <p>14  - Return to previous
menu, cancel an action 24</p> |
|--|--|---|

NAVI 50 (Type A)

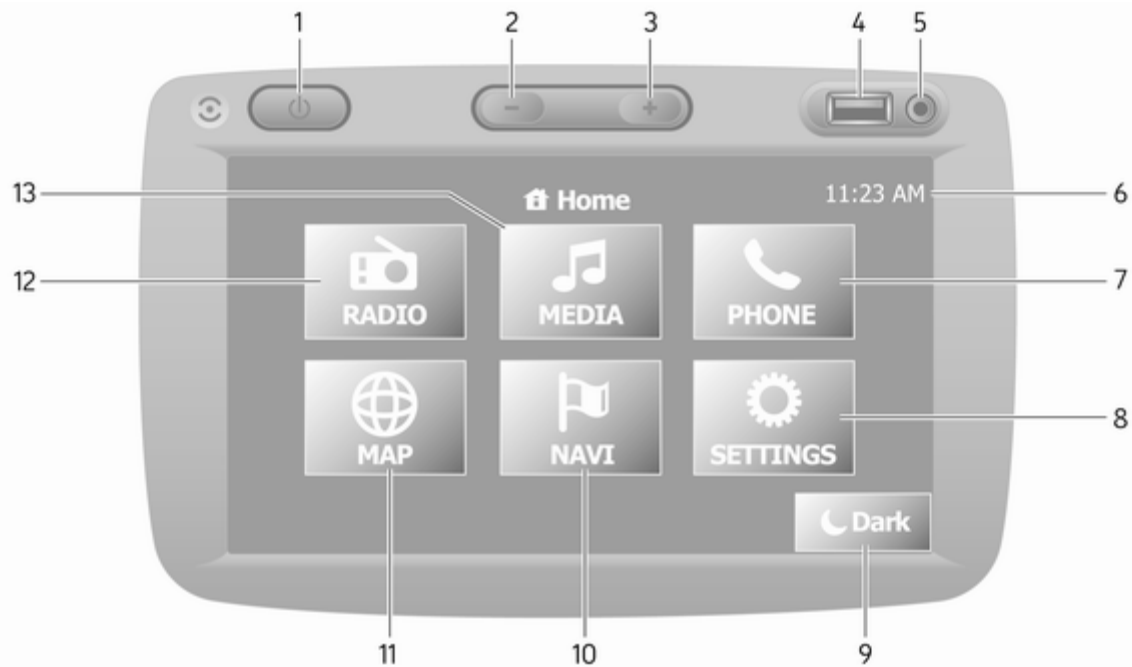

-
- | | | | | | |
|----|---|-----|----|--|----|
| 1 | ⓘ: Switch on/off | 24 | 13 | 🎵 MEDIA : Change audio source - USB, iPod | 61 |
| 2 | ⏮: Decrease volume | 24 | | BT (Bluetooth) | 65 |
| 3 | ⏭: Increase volume | 24 | | AUX | 59 |
| 4 | USB port | 61 | | | |
| 5 | AUX input | 59 | | | |
| 6 | Clock | 24 | | | |
| 7 | ☎ PHONE : Telephone menu | 122 | | | |
| 8 | ⚙ SETTINGS : Audio settings, e.g. "Tone settings" | 36 | | | |
| | "Volume settings" | 39 | | | |
| | Bluetooth settings | 24 | | | |
| | Display settings | 24 | | | |
| | System settings | 40 | | | |
| 9 | 🌑 Dark : Darken screen (only clock and audio system information are displayed) | 24 | | | |
| 10 | 🗺 NAVI : Navigation menu | 74 | | | |
| 11 | 🌐 MAP : View map | 74 | | | |
| 12 | 📻 RADIO : Change audio source to radio | 45 | | | |

NAVI 50 (Type B)

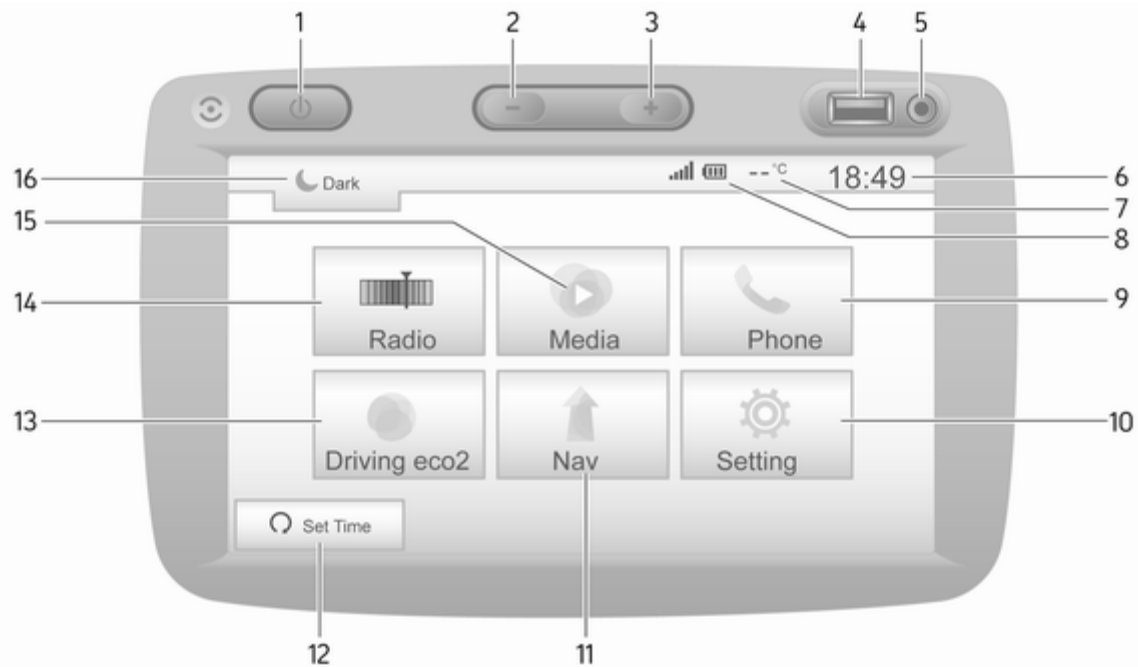

- | | |
|---|--|
| <p>1 : Switch on/off 24</p> <p>2 : Decrease volume 24</p> <p>3 : Increase volume 24</p> <p>4 USB port 61</p> <p>5 AUX input 59</p> <p>6 Clock 24</p> <p>7 Outside temperature 24</p> <p>8 : Phone reception 122</p> <p>: Battery life 122</p> <p>9 Phone: Telephone menu . 122</p> <p>10 Setting: Audio settings,
e.g. "Tone settings" 36</p> <p>"Volume settings" 39</p> <p>Bluetooth settings 24</p> <p>Display settings 24</p> <p>System settings 40</p> <p>11 Nav: Navigation menu 74</p> <p>12 (Depending on current
mode) Set Time:
Remote engine start-up 24</p> <p>: Go to Home page 24</p> | <p>/ : Press to return to
previous screen - or -
press and hold to go to
Home page 24</p> <p>: Return to Navigation
menu 78</p> <p>13 Driving eco2: Driving
economy 24</p> <p>14 Radio: Change audio
source to radio 45</p> <p>15 Media: Change audio
source - USB, iPod 61</p> <p>BT (Bluetooth) 65</p> <p>AUX 59</p> <p>Aha® application 24</p> <p>16 Dark: Darken screen
(only clock and audio
system information are
displayed) 24</p> |
|---|--|

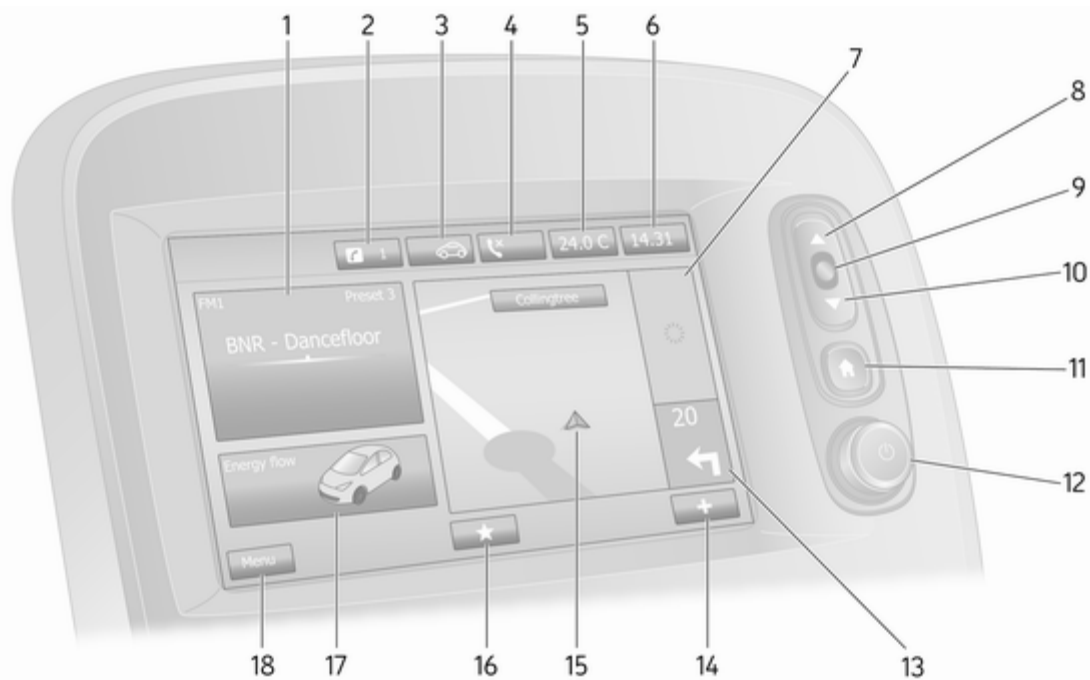

- | | |
|--|--|
| <p>1 Audio information, e.g.
Radio 45</p> <p>Auxiliary devices 59</p> <p>ψ USB devices 61</p> <p>Bluetooth music 65</p> <p>2 ⚙: System notifications 24</p> <p>3 🌬: Outside air quality 24</p> <p>Eco Function 24</p> <p>4 📞: Telephone status 122</p> <p>Call log 131</p> <p>5 Outside temperature 24</p> <p>6 Clock 24</p> <p>7 Traffic information 106</p> <p>8 ▲: Display lists - Scroll up 24</p> <p>Map: Change scale 106</p> <p>9 Enter menus, confirm actions 24</p> <p>10 ▼: Display lists - Scroll down 24</p> <p>Map: Change scale 106</p> <p>11 🏠: Home page 24</p> | <p>12 ⏻ - Press: Switch on/off 24</p> <p>Turn: Change volume 24</p> <p>13 Navigation: Direction and distance to next change of direction 74</p> <p>14 +: Pop-up menu 24</p> <p>15 Navigation display 74</p> <p>Map 106</p> <p>16 ★: Favourites, e.g. for Navigation 74</p> <p>Media (e.g. Radio) 45</p> <p>Phone 122</p> <p>Services 78</p> <p>17 Driving economy 24</p> <p>18 Menu: Access Main menu 24</p> |
|--|--|

Steering column controls - Type A

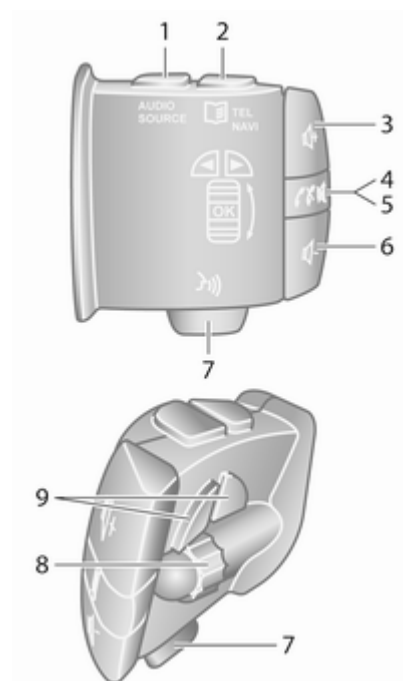

1	AUDIO/SOURCE - Change audio source	24
2	TEL - Telephone menu	122
	NAVI - Navigation menu	78
3	+ - Increase volume	24
4	M - Mute/unmute	24
5	☎ - Take/end phone call ..	131
6	- - Decrease volume	24
7	V - Voice recognition	120
8	OK - Confirm actions	45
	Turn: Move up/down in display menus, select next/previous radio preset / radio frequency / audio track	47
9	◀ / ▶ - Move left/right within display text, move around display screen	56

**Steering column controls -
Type B**

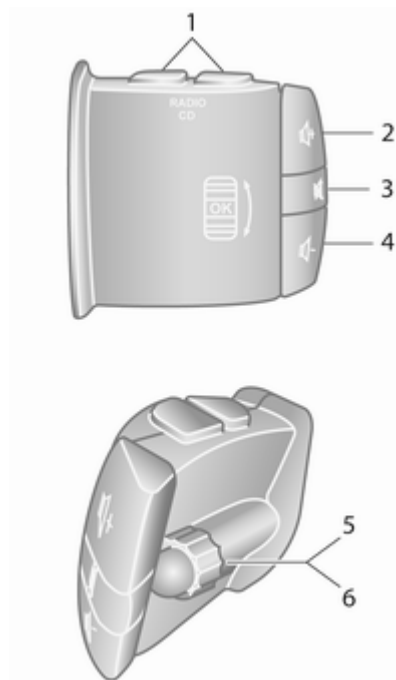

1	RADIO/CD - Change audio source	45
	MEDIA - Change audio source	45
2	+ - Increase volume	24
3	M - Mute/unmute	24
4	- - Decrease volume	24
5	Short press: Change radio source/waveband	45
	Long press: Automatic station storing	50
6	Turn: Change radio frequency	47
	Short press: Select audio track (CD player mode)	56
	Long press: Fast forward/ rewind an audio track (CD player mode)	56

Steering column controls - Type C

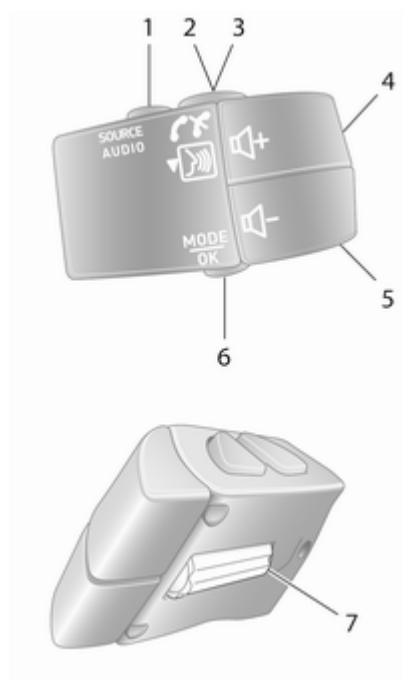

- | | | |
|---|--|-----|
| 1 | SOURCE/AUDIO -
Change audio source | 24 |
| 2 | | 122 |
| | Take/end phone call | 131 |
| | - Mute/unmute | 24 |
| 3 | - Activate voice
recognition | 120 |
| 4 | - Increase volume,
mute/unmute | 24 |
| 5 | - Decrease volume,
mute/unmute | 24 |
| 6 | MODE/OK - Confirm
actions, change audio
mode | 45 |
| | Take/end phone call | 131 |
| 7 | Turn: Access display
menu options, next/
previous radio preset /
radio frequency / audio
track | 45 |

Theft-deterrent feature

Depending on Infotainment system, an electronic security system is included for the purpose of theft deterrence. The Infotainment system functions only in your vehicle and is therefore worthless to a thief.

The security code (supplied separately) must be entered upon first use of the system and after prolonged interruptions to the power supply.

Note

The security code is not required for R16 BT USB, CD18 BT USB.

Entering the security code

When first switching on the Infotainment system, an enter security code message, e.g. **Radio code** followed by **0000** appears on the display screen. Depending on Infotainment system, the message may only appear after a brief delay.

To enter first digit of security code, press numbered button **1** on the unit repeatedly until desired number is

displayed. Enter second, third and fourth digits using buttons **2**, **3** and **4** in the same way.

When the full code is displayed, press and hold button **6** until an audible signal sounds. The system is unlocked when the correct code has been entered.

NAVI 50: Enter the security code using numbered buttons **0** to **9** on the touchscreen display. The system is unlocked when the correct code has been entered.

Incorrect code entered

Depending on Infotainment system, when the security code has been entered incorrectly, an incorrect code message, e.g. **Error code** followed by a countdown value, e.g. **Wait 100** is displayed.

Wait until the countdown has expired, then enter the correct code. Each time the code is entered incorrectly, the countdown time may be doubled, depending on Infotainment system.

Changing the geographical area

When the security code is entered, depending on Infotainment system you may be prompted to choose a geographical area, for example:

- Europe
- Asia
- Arabia
- America

Switch off the Infotainment system, then simultaneously press button **1** and **5** and \odot . Then press \blacktriangleleft or \blacktriangleright until desired area is highlighted on the display screen and set with button **6**.

Usage

Infotainment controls

The Infotainment system is operated via buttons, rotary knobs and/or display menus.

Inputs are made via:

- the central control unit in the instrument panel \curvearrowright 6, or
- the controls on the steering column \curvearrowright 6

- the voice recognition system (if available) \curvearrowright 118
- the touch screen (NAVI 50, NAVI 80) \curvearrowright 6

Switching the Infotainment system on or off

Press \odot to switch the Infotainment system on.

The previously used audio source is active.

Press \odot (or, depending on Infotainment system, press and hold) to switch the Infotainment system off.

Note

The clock is displayed when the Infotainment system is switched off.

NAVI 50:

The Infotainment system automatically switches on/off when the ignition is switched on/off. Press \odot instead, if required.

Note

The clock and the outside temperature (depending on version) are displayed when the Infotainment system is switched off.

NAVI 80:

The Infotainment system automatically switches on when the ignition is switched on. Press \odot instead, if required.

The following options are displayed:

- **Change settings** (to authorise or reject data sharing)

Note

When data sharing is switched off, certain applications may not operate correctly.

- **Language** (to change the system language)
- **Done** (to continue to the Home page)

The Infotainment system automatically switches off when the ignition is switched off and the driver's door is opened. Press \odot instead, if required.

Note

The clock and the outside temperature are displayed when the Infotainment system is switched off.

Automatic switch-off

With the ignition off, if the Infotainment system is switched on with \odot , it will switch-off automatically a short period after the last user input. Depending on Infotainment system, automatic switch-off occurs after approx. 5 to 20 minutes.

Pressing \odot again will allow the Infotainment system to remain on for a further 5 to 20 minutes.

Setting the volume

Turn \odot /volume rotary knob, or press **+** or **-**.

Alternatively (with the steering column controls), press \blacktriangleleft or \blacktriangleright .

NAVI 50:

Depending on version, it is possible to set various volume levels individually (including audio players, traffic announcements, navigation instructions, phone calls and ringtone).

From the Home page, press **⚙ Settings** then **Audio** followed by **Sound** on the display screen.

Refer to (NAVI 50) "Volume settings" \blacktriangleright 39.

NAVI 80:

To set various volume levels individually (e.g. navigation instructions, traffic announcements, phone calls) from the Home page, press **MENU** then **System** followed by **Sound** on the display screen.

Refer to (NAVI 80) "System settings" \blacktriangleright 40.

Stored volume





When the Infotainment system is switched off, the current volume is stored.

Speed dependent volume

When speed dependent volume (\blacktriangleright 39) is activated, the volume is adapted automatically to compensate for road and wind noise.



Mute

To mute the current audio source (depending on Infotainment system), press \odot briefly or turn knob fully anticlockwise.

Alternatively (with the steering column controls), press  or  or press  and  simultaneously.

Unmute

To unmute (depending on Infotainment system), briefly press  again or turn clockwise.

Alternatively (with the steering column controls): Press  again or press  and  simultaneously again.

Note

When a traffic announcement is broadcast, the system is automatically unmuted.

For further information, refer to "Radio data system" ⇨ 51.

Display screen operation

R15 BT USB, R16 BT USB, CD16 BT USB, CD18 BT USB - Display screen operation









- To move up/down in the display: Turn **OK**.
- To confirm actions: Press **OK**.
- To cancel actions (and return to previous menu): Press .

CD35 BT USB - Display screen operation

- To move up/down in the display: Turn the central rotary knob.
- To confirm actions: Press the central rotary knob.
- To cancel actions (and return to previous menu): Press .

NAVI 50 - Display screen operation

Use the touchscreen for the following displayed menus as described in each section:



-   **RADIO**
Refer to "Radio" section ⇨ 45.
-   **MEDIA**
Refer to "USB port" section ⇨ 61.
-  **PHONE**
Refer to "Phone" section ⇨ 122.
-  **MAP**
Refer to "Navigation" section ⇨ 74.
-  **NAVI** /  **Nav**
Refer to "Navigation" section ⇨ 74.

-  **Driving eco2**

Refer to "Additional features (NAVI 50)" in the "Modes of operation" section below.

-  **SETTINGS**

Refer to (NAVI 50) "Tone settings" ⇨ 36, "Volume settings" ⇨ 39 and "System settings" ⇨ 40.

When the Home page  is displayed, it is possible to hide these menus from the display (only clock and audio system information may be shown) by pressing  **Dark**. Press anywhere on the screen to display these menus again.

NAVI 80 - Display screen operation

Use the touchscreen for the following displayed menus as described in each section.



On the Home page, press **MENU** on the display screen to access the Main menu. The following menus and controls are displayed:

- **↑ Navigation**
Refer to "Navigation" section ↷ 74.
- **♪ Multimedia**
Refer to "Radio" section ↷ 45.
Refer to "AUX input" ↷ 59.
Refer to "USB port" section ↷ 61.
Refer to Bluetooth music ↷ 65.
- **☎ Phone**
Refer to "Phone" section ↷ 122.

- **🚗 Vehicle**
Press to open Driving Eco², Care (e.g. outside air quality), On-board computer and Settings menus.
Refer to (NAVI 80) "Modes of operation" below.
- **@ Services**
Press to open Store, Navigation services, Applications and Settings menus.
Refer to (NAVI 80) "Modes of operation" below.
- **⚙ System**
Refer to (NAVI 80) "System settings" ↷ 40.
- **<: Move to previous page**
- **>: Move to next page**
- **⊕: Open pop-up menu**
- **←: Return to previous menu**

The display screen can also be operated using the following controls on the Infotainment system fascia:

- **🏠: Home page**
- **▲: Display lists; Scroll up**
Map; Change scale
- **Central button: Enter menus, confirm actions**
- **▼: Display lists; Scroll down**
Map; Change scale

Note

Depending on vehicle, operation of the touchscreen may be restricted during driving.

Modes of operation

Radio

To change the audio source to radio: Depending on Infotainment system, press **RADIO**, **RADIO/CD** or **AUDIO/SOURCE**.

NAVI 50

To access the radio menu at any time, press **🏠** followed by **📻/📺 Radio** on the display screen.





NAVI 80

To access the radio menu from the Home page, press **MENU** then **Multimedia** followed by **Radio** on the display screen

Detailed description of the radio functions ⇨ 45.

Audio players

To change the audio source to **CD**, **USB**, **AUX**, Bluetooth or iPod (where applicable): Depending on Infotainment system, press **MEDIA**, **RADIO/CD** or **AUDIO/SOURCE**.

NAVI 50: To access the menu for connected auxiliary devices (**USB**, **iPod**, **BT** (Bluetooth) or **AUX**) at any time, press  followed by 
 **Media** on the display screen. Press  in top left corner and select auxiliary source.

For **Aha®** application (available depending on version), refer to "Additional features (NAVI 50)" below.

NAVI 80: To access the menu for auxiliary devices (USB, SD card, AUX input, Audio CD, Bluetooth) from the Home page, press **MENU** then

Multimedia followed by **Media** on the display screen. Select auxiliary source from the display list.

R15 BT USB, R16 BT USB

Detailed descriptions of:

- AUX input functions ⇨ 59
- USB port functions ⇨ 61
- Bluetooth music operation ⇨ 65

CD16 BT USB, CD18 BT USB

Detailed descriptions of:

- CD player functions ⇨ 56
- AUX input functions ⇨ 59
- USB port functions ⇨ 61
- Bluetooth music operation ⇨ 65

CD35 BT USB

Detailed descriptions of:

- CD player functions ⇨ 56
- AUX input functions ⇨ 59
- USB port functions ⇨ 61
- Bluetooth music operation ⇨ 65

NAVI 50

Detailed descriptions of:

- AUX input functions ⇨ 59
- USB port (including iPod) functions ⇨ 61
- Bluetooth music operation ⇨ 65

NAVI 80

Detailed descriptions of:

- AUX input functions ⇨ 59
- USB port functions ⇨ 61
- Bluetooth music operation ⇨ 65

Navigation, Map

(CD35 BT USB NAVI, NAVI 50, NAVI 80)

Detailed description of the Navigation system ⇨ 74, Browse map ⇨ 106.

Phone

Use the display options in the following menus to connect mobile phones, make telephone calls, create contacts lists and adjust various settings.

Detailed description of the handsfree phone system functions ⇨ 122.

R15 BT USB, R16 BT USB, CD16 BT USB, CD18 BT USB - Phone

To access the **Phone** menu: Press  or **TEL**.



To access the phone settings menu: Press **TEL** and select **Phone settings**.

CD35 BT USB - Phone

To access the **Phone** menu: Press  or **TEL**.

To access the phone settings menu: Press **SETUP / TEXT** and select **Phone settings**.

NAVI 50 - Phone

To access the Phone menu at any time: Press  followed by  **Phone** on the display screen.

NAVI 80 - Phone

To access the Phone menu from the Home page, press **MENU** followed by **Phone** on the display screen.

Vehicle information (NAVI 80)

To access the Vehicle menu from the Home page, press **MENU** followed by **Vehicle** on the display screen.

Depending on vehicle, the following menus are displayed:

- **Driving Eco²**
- **Care**
- **On-board computer**
- **Settings**

Driving Eco²

The following features are available:

- **Trip report**
Displays the following data from the last journey:
Average fuel consumption, average speed, total fuel consumption, recovered energy or mileage completed, average environmental driving performance, braking anticipation, ability to manage vehicle speed.

To save journey data: Press 'Save' then select the journey type from the following list:

Home/work, holiday, weekend, trip, personal.

To reset journey data: Press 'Reset'. Confirm or cancel with 'Yes' or 'No'.

- **My preferred trips**

Displays changes in your driving style (when journey data has been saved).

The 'Summary' tab displays the following: Total route distance, distance covered, date of information update, average rating out of 100.

The 'Details' tab displays journey record information.

- **Eco coaching**

Displays advice for reducing fuel consumption



Scroll through the pages and familiarise yourself with the advice.

Care

The following features are available:

- **Ioniser**: Select 'Clean' mode to help reduce bacteria and allergens in the air, or select 'Relax' mode to improve the driving environment through the emission of ions. Operation stops automatically after 30 minutes. Switch off if not required.

To activate automatic operation, press 'Start ioniser at each vehicle start' (tick box checked).

- **Scent diffuser:** Change fragrance type and diffusion intensity in the passenger compartment.
- **Outside air quality:** Displays a chart of outside air quality over a period of time, rated from  'Good' to  'Polluted -' (low level) to  'Polluted +' (high level).

Press **Done** to confirm changes.

On-board computer

Displays the following information since the last reset:

- start date of calculation
- total distance
- average speed
- average fuel consumption
- total fuel or energy consumption

To reset on-board computer and instrument panel trip computer information, press **Reset** then **Yes** to confirm.

For further information, refer to "Trip computer" in the Owner's Manual.

Settings

The following settings can be changed:

- **Park Assist**

- Depending on vehicle, press **Front park assist** or **Rear park assist** to switch on/off (box is checked/unchecked). Press **Confirm** to save changes.

- **Volume:**

Press **+** or **-** alongside the volume bar to change volume of the ultrasonic parking assist system. For further information, refer to "Parking assist" in the Owner's Manual.

- **Rear camera view settings:**

Select to switch rear view camera on/off, change guidelines (static/dynamic) and adjust image settings (e.g. brightness, saturation and contrast).

Press **Done** to save changes. For further information, refer

to "Rear view camera" in the Owner's Manual.

- **+** (pop-up menu):

Press **+** in the **Park Assist** menu or submenus followed by **Reset to the default values** to restore default factory settings for all or current Park Assist options.

- **Image settings**

To adjust e.g., brightness, saturation and contrast.

- The following options (depending on vehicle) can also be adjusted:
 - Automatically fold in the exterior mirrors to the parking position upon locking the vehicle (switch on/off)
 - Lock/unlock doors while driving
 - Activate rear window wiper when selecting reverse gear (switch on/off)
 - Daytime running lights (switch on/off)

- Unlock the driver's door only when opening the door (switch on/off)
- Easy access (switch on/off)
- Driving style indicator (fuel economy gauge) in the instrument cluster (switch on/off)
- Eco score (switch on/off)

Services (NAVI 80)

To access the Services menu from the Home page, press **MENU** followed by **Services** on the display screen.

The following menus are displayed:

- **Store**
- **Navigation services**
- **Settings**
- Applications (e.g. calculator, reader)

Store

Select to access the online store and purchase applications for your Infotainment system.

The following options are displayed:

- **Selection:** Displays a list of applications.
- **Top apps:** Sorts applications by order of popularity.
- **Categories:** Displays applications by theme, e.g. entertainment, maps.
- **+ (pop-up menu):**
 - **Search:** Search using key words.
 - **Update:** Search for updates to applications, services and downloaded content.
 - **My products:** Summary of applications, services and downloaded content and their expiry dates.
 - **Legal information:** Displays the legal information regarding the Store.

When new content is selected for download, press **Purchase** to choose the type of payment; select credit card or debit card. Tick the box to accept the conditions of sale, then continue with payment.

Enter a valid email address, then press **OK** to confirm.

Note

Invoices are sent to the entered email address, with (if necessary) the install instructions and user information for the applications, services or other downloaded content.

Enter the payment card details. Press **Done** to confirm and the download begins immediately. When the application is downloaded, its icon is displayed in the **Services** menu.

Note

Download time can vary depending on size of application and network reception quality.

Payment card details and email addresses are automatically saved. Saved payment cards can be selected via **Pay with a card already saved in the memory** when making future purchases.

To delete payment cards, press  alongside the required payment card. To delete email addresses, select the icon alongside the email line to open

a list of email addresses and press  alongside the required email address.

Navigation services

In addition to the free navigation services (e.g. traffic information, fixed speed cameras), extra features can be added by subscribing to paid LIVE services.

Refer to (NAVI 80) "LIVE services" in the "Navigation" section ⇨ 78.

Settings

The following menus are displayed:

- **Applications manager**

Select to delete application data, uninstall applications and view the "about", "system usage" and "confidentiality" information.

To delete content, select the application then press **+** followed by **Delete application** or **Delete application data**.

- **Connectivity manager**

Select to manage Bluetooth auxiliary devices.

- **Navigation services**

Select to access navigation related features, e.g. traffic, speed cameras, local search, My TomTom LIVE, weather.

Refer to (NAVI 80) "LIVE services" in the "Navigation" section ⇨ 78.

- **Update applications**

Select to search for updates to downloaded applications.

- **Data sharing settings**

Select to switch data sharing on/off.

Note

When data sharing is switched off, certain applications may not operate correctly.

- **Activate/deactivate Bluetooth**

Select to switch Bluetooth on/off. A confirmation message is displayed.

Applications





Icons for various applications, services and other content downloaded to the Infotainment

system are displayed. Select the appropriate icon to start the application.

Some applications are free to use during the initial trial period. Renew subscriptions via the Store.

Favourites (NAVI 80)

When the Home page is displayed, press **★** to view, add or delete favourites for the following features:

-  **Navigation** ⇨ 74.
-  **Multimedia** - refer to "Radio" ⇨ 45.
-  **Phone** ⇨ 122.
-  **Services** ⇨ 78.

Navigation favourites

Select an empty slot in the display or press **+** (to open a pop-up menu), then select **Add Favourite**.

Choose from the displayed list to add a saved destination to the favourites.

For further information, refer to (NAVI 80) "Destination input" in the "Navigation" section ⇨ 97.

Multimedia favourites

Select an empty slot in the display or press **+** (to open a pop-up menu), then **Add Favourite**.

Choose from the displayed list to add a preset FM radio station to the favourites.

Phone favourites

Select an empty slot in the display or press **+** (to open a pop-up menu), then **Add Favourite**.

Choose from the displayed list to add a phone contact to the favourites.

For further information, refer to (NAVI 80) "Phonebook" in the "Phone" section ↷ 131.

Services favourites

Select an empty slot in the display or press **+** (to open a pop-up menu), then **Add Favourite**.

Choose from the displayed list to add an installed application to the favourites.

Delete favourites

Press **+** and select **Remove all Favourites** or select a favourite from the displayed list then press **Remove a Favourite**. A confirmation message is displayed. Press **Delete** to confirm.

Additional features (NAVI 50)

Depending on version, the following additional features are available:

- Remote engine start-up
- Rear camera view settings
- Driving eco2 function (driving economy)
- Aha® application (for smartphones)

Remote engine start-up

Danger

Never leave a child or an animal inside the vehicle, even for a brief period, when the remote engine start-up feature is activated (to avoid unintended operation of

windows, doors or transmission etc. in the event the engine starts automatically).

Risk of fatal injury.

Available depending on vehicle, the remote engine start-up system enables an automatic start-up of the engine to be programmed, to either heat or ventilate the passenger compartment before entering the vehicle. The vehicle can be programmed to be ready for use at any time of day and upto 24 hours in advance.

Note

Climate control settings (temperature, fan speed, air distribution, air conditioning) must be set as required before leaving the vehicle.

From the Home page, press **Q Set Time** on the display screen.

The following settings and features are available:

- **Automatic Start** (Off/On)
- **Car Ready for** (Press "Change" to change the automatic start-up time)
- **Wake up every 2 hours** (Off/On)
- **Car will be ready in** (e.g. 0 hours & 0 minutes)

To activate the function, select "On" beside **Automatic Start** then press "Change" beside **Car Ready for** and use ▲/ ▼ to change the hours and minutes on the 'Departure Time Set' screen. Confirm by pressing **OK**.

The **Car will be ready in** section is updated to indicate the time remaining before the set time.

The following conditions must be fulfilled for the remote engine start-up to operate:

- The gearshift lever must be in neutral.
- The ignition must be switched off.
- All doors, bonnet and load compartment must be closed and locked.

The **Wake up every 2 hours** function enables the engine to be started automatically every 2 hours if the outside temperature drops below -15°C .

If necessary, the engine starts automatically and operates for approx. 10 minutes before switching off, and is restarted every 2 hours depending on the outside temperature. Press "On" to activate or "Off" to deactivate this function.

⚠ Danger

Do not use the remote engine start-up function, including the 'Wake up every 2 hours' feature, when the vehicle is to be parked in a garage or a confined space.

Risk of poisoning or suffocation by engine exhaust gas emissions.

When returning to the Home page, the time input on the 'Departure Time Set' screen appears alongside Ω (instead of **Set Time**) on the display screen.

⚠ Warning

Do not park the vehicle on an easily ignitable surface when the remote engine start-up feature is activated. The high temperature of the exhaust system could ignite the surface.

⚠ Warning

Do not use the remote engine start-up feature when the vehicle is to be covered by a protective cover or tarpaulin, to avoid the risk of fire.

⚠ Danger

Deactivate the remote engine start-up feature before opening the bonnet, to avoid the risk of burns or fatal injury.

Rear camera view settings

When the rear camera view is shown on the display, press **⚙ Setting** to open the settings menu.

The following settings can be updated:

- Switch the rear camera view display **Off/On**.
- Colours
Press **−/+** to adjust level.
- Brightness
Press **−/+** to adjust level.
- Contrast
Press **−/+** to adjust level.

For further information, refer to "Rear view camera" section in the vehicle Owner's Manual.

Driving eco2 function (driving economy)

Driving eco2 provides statistical information and advice regarding driving economy.

From the Home page, press **Vehicle** then select  **Driving eco2** on the display screen.

Note

Depending on version, Driving eco2 may appear instead on the Home page.

The following menus are displayed:

- **Trip report**
- **Eco scoring**
- **Eco coaching**

Trip report displays data from the last journey, including "Average consumption", "Total consumption", "Average Speed" and "Dist. without consumption". Data can be reset by pressing .

Eco scoring provides an overall score out of 100 for driving economy. Higher figures indicate better driving economy. Star ratings are also given for average environmental driving performance (Acceleration), gearchanging efficiency (Gearbox) and brake control (Anticipation).

Eco coaching provides an assessment of your driving style and displays advice for optimising fuel consumption.

Aha® application

The Aha® app enables you to organise favourite smartphone internet content (e.g. podcasts, audio books, internet radio, social network sites etc.) and access favourites

instantly. Aha® can also be used during navigation, to suggest e.g. hotels and restaurants in the vicinity, and provide weather information and current GPS position.

Aha® must first be downloaded onto your smartphone. Launch the app on your smartphone and create a user account to enable use via the Infotainment system.

To connect to Aha® via the Infotainment system, a bluetooth connection must be set up between the smartphone and the Infotainment system, i.e. the device must be paired to the vehicle before using it. Refer to "Bluetooth connection" in the "Phone" section ⇨ 127 for further information.

Note

Data sharing and location services must be enabled on the smartphone to use the Aha® app. During use, data transfer may incur additional costs not included in the contract with your network provider.

When a bluetooth connection is active, Aha® can be accessed via the Infotainment system. From the Home page, press  **Media** on the

display screen. Press ▼ in top left corner to display the list of auxiliary sources, then select **aha**.

The following menus are displayed:

- **Player**
- **List**
- **Presets**
- **Nearby**

To access your Aha® favourites, select **Presets**.

While using the navigation system ⇨ 74, to find a nearby point of interest (POI) with Aha® press **Nearby** and select a group (e.g. hotel, restaurant). A range of POIs in the vicinity are displayed; press on the required POI. The POI can be set as either a destination or a waypoint by pressing **Ⓜ**.

Depending on POI type, contact details and further information may be displayed. When phone numbers are provided for POIs, they can also be dialled using the handsfree phone system by pressing **☎**.

For further information, refer to "Operation" in the "Phone" section ⇨ 131.

Tone settings

R15 BT USB - Tone settings

In the audio settings menu, the tone characteristics can be set.

Press **SETUP** to access the settings menu.

Select **Audio settings** and turn **OK** until the desired setting is selected from:

- **BASS** (bass)
- **TREBLE** (treble)
- **FADER** (front/rear balance)
- **BALANCE** (left/right balance)

The display indicates the type of setting followed by the adjustment value.

Set the desired value by turning **OK** and press the knob to confirm selections.

To exit the audio settings menu, press **↩**.

Note

If there is no activity, the system will exit the audio settings menu automatically.

Setting bass and treble

Select **Bass** or **Treble**.

Set the desired value by turning **OK** and press the knob to confirm setting.

Setting the volume distribution between right - left

Select **Balance**.

Set the desired value by turning **OK** and press the knob to confirm setting.

Setting the volume distribution between front - rear

Select **Fader**.

Set the desired value by turning **OK** and press the knob to confirm setting.

CD35 BT USB - Tone settings

In the audio settings menu, the tone characteristics can be set.

Press **SETUP / TEXT** to access the settings menu.

Select **Audio settings** and turn the central rotary knob until the desired setting is selected.

The display indicates the type of setting followed by the adjustment value.

A value of **0** means the function is deactivated.

To exit the settings menu, press **SETUP / TEXT** (or \rightarrow).

Note

If there is no activity, the system will exit the audio settings menu automatically.

Optimising the tone for the style of music

Select the **Musical atmosphere** menu.

Turn the rotary knob to select from:

- **Pop/ Rock**
- **Classical**
- **Jazz**
- **Neutral**

The displayed options offer optimised bass, middle and treble settings for the relevant style of music.

Set the style of music by pressing the central rotary knob.

Setting bass and treble

Select the **Musical atmosphere** menu.

Turn the central rotary knob to select **Bass/treble** and press knob to confirm.

Turn the central rotary knob to access **Bass** or **Treble** and press knob to confirm.

Set the desired value for the selected option by turning the central rotary knob and press knob to confirm.

Optimising the sound distribution

Select the **Sound optimisation** menu.

To optimise the sound distribution for the entire vehicle or just the driver, turn the central rotary knob to select from: **Vehicle** or **Driver**.

Set by pressing the knob.

Setting the volume distribution between right - left

Select the **Sound optimisation** menu.

Turn the central rotary knob to select **Balance/fader**. Press knob to display current setting for **Balance** and turn knob to adjust.

Press knob to set the desired value and display the **Fader** setting.

Setting the volume distribution between front - rear

The **Fader** setting is displayed after **Balance** has been set.

Turn the central rotary knob to adjust the fader between front/rear.

Moderate volume in the front

To suppress the volume in the rear and moderate only the volume in the front of the vehicle:

Select the **Sound optimisation** menu.

Turn the central rotary knob to select **Rear OFF** and press knob to set.

Automatic Gain Control (AGC)

To switch on low volume sound enhancement:

Select the **AGC Activated** menu and press the central rotary knob to activate.

Restore default audio settings

Select **Default settings** and press the central rotary knob to confirm.

All the audio settings return to their default values.

Display software version

To display the software version, access the **Software version** menu and press the central rotary knob.

NAVI 50 - Tone settings

To access the settings menu at any time, press **HOME** followed by **Settings** on the display screen.

The following settings submenus are displayed:

- **Audio**
See "Audio settings" below.
- **Display**
Refer to (NAVI 50) "System settings" ↻ 40.

- **Bluetooth**
Refer to (NAVI 50) "System settings" ↻ 40.
- **System**
Refer to (NAVI 50) "System settings" ↻ 40.

Audio settings

Select **Audio** to display the following options:

- **Vol/Speed** (Off/1/2/3/4/5)
Speed dependent volume control - refer to (NAVI 50) "Volume settings" ↻ 39.
- **Loudness** (On/Off)
Switch loudness on to increase bass and treble levels.
- **BAL/FAD**
Available depending on version. Press **▶** to open the volume distribution balance and tone settings submenu.
On the left side of the display, adjust the right/left balance with **◀/▶** and the front/rear balance with **▲/▼**.

On the right side of the display, adjust the **Bass, Mid** and **Treble** tone characteristics (between -5 to +5) with **◀/▶**.

Press **OK** to confirm changes.

- **Sound**

Depending on version, press **▶** to open the volume distribution balance and tone settings submenu.

On the left side of the display, adjust the right/left balance with **◀/▶** and the front/rear balance with **▲/▼**.

On the right side of the display, adjust the **Bass, Mid** and **Treble** tone characteristics (between -5 to +5) with **◀/▶**.

Press **OK** to confirm changes.

For other versions of the sound submenu (where volumes can be set individually for a list of audio types), refer to (NAVI 50) "Volume settings" ↻ 39.

Volume settings

CD35 BT USB - Volume settings

Speed dependent volume

When this feature is activated, the volume is adapted automatically to compensate for road and wind noise during driving.

Press **SETUP / TEXT** to access the settings menu. Select **Audio settings** followed by **Adaptation volume km/h** by turning the central rotary knob and pressing to confirm the selection.

Turn the knob to set the degree of volume adaptation.

A value of **0** means the function is deactivated.

NAVI 50 - Volume settings

To access the settings menu at any time, press **HOME** followed by **Settings** on the display screen.

The following settings submenus are displayed:

- **Audio**
See "Audio settings" below.
- **Display**
Refer to (NAVI 50) "System settings" ⇨ 40.
- **Bluetooth**
Refer to (NAVI 50) "System settings" ⇨ 40.
- **System**
Refer to (NAVI 50) "System settings" ⇨ 40.

Audio settings

Select **Audio** to display the following options:

- **Vol/Speed (Off/1/2/3/4/5)**
The volume increases when vehicle speed increases, to compensate for wind and road noise.
Speed compensated volume can be switched off or the degree of volume adaptation can be set.

- **Loudness (On/Off)**
Switch loudness on to increase bass and treble levels.
- **BAL/FAD**
Refer to (NAVI 50) "Tone settings" ⇨ 36.
- **Sound**
Press **▶** to open the audio preferences submenu.
Depending on version, the volume of different audio types can be set independently, e.g. audio, traffic announcements, navigation instructions, handsfree phone system and ringtone levels. Press **←/+** to adjust volume of each audio type.
If required, press **Reset to defaults** to return all volumes to the factory settings.
For other versions of the sound submenu, refer to (NAVI 50) "Tone settings" ⇨ 36.

System settings

R15 BT USB, R16 BT USB, CD16 BT USB, CD18 BT USB - System settings

Press **SETUP** and access the settings menu by turning and pressing **OK**.

When system setting adjustments have been made, press **SETUP** to exit the menu and save changes. The system also saves and exits automatically after a delay.

Change system language

Change the display language by accessing the **Language** menu. Select a language from the list by turning and pressing **OK**.

Restore default system settings

To restore system settings to their default values, select **Default settings** by turning and pressing **OK**. Confirm modification when prompted by pressing **OK** again.

CD35 BT USB - System settings

Press **SETUP / TEXT** to access the settings menu.

When system setting adjustments have been made, press **SETUP / TEXT** to exit the menu and save changes. The system also saves and exits automatically after a delay.

Set the clock

To set the time, access the **Clock** menu. Turn the central rotary knob to adjust the **Hours** setting, then press the knob to confirm. Turn the knob to adjust the **Minutes** setting and press to confirm.

Change system language

Change the display language by accessing the **Language** menu. Turn the central rotary knob to select one of the 9 languages from the list, then press the knob to confirm.

Restore default system settings

To restore system settings to their default values, select **Default settings** by turning and pressing the central rotary knob. Confirm modification when prompted by pressing the knob again.

NAVI 50 - System settings

To access the settings menu at any time, press **⬆** followed by **⚙ Settings** on the display screen.

The following settings submenus are displayed:

- **Audio:**
Refer to (NAVI 50) "Tone settings" ⇨ 36 and "Volume settings" ⇨ 39.
- **Display:** See below.
- **Bluetooth:** See below.
- **System:** See below.

Display

Select **Display** to display the following options:

- **Brightness** (Low/Mid/High)
- **Map mode** (Auto/Day/Night)
 - **Auto:** Day and night mode are changed automatically.
 - **Day:** The map screen is always displayed with bright colours.
 - **Night:** The map screen is always displayed with dark colours.

- **AC Info (On/Off)**
Available depending on version. Switch on/off the display of air conditioning information during adjustment of settings (available depending on vehicle).
- **Background (Dark/Light)**
Available depending on version. Switch between a dark or light display mode (available depending on vehicle).

Bluetooth

Select **Bluetooth** to display the following options:

- **View Bluetooth device list**
- **Search for Bluetooth device**
- **External device authorisation**
- **Change passkey** (for pairing of Bluetooth devices with the Infotainment system)
- **Smartphone**
Available depending on version. For help with activating and operating voice controls - refer to "Voice recognition" ⇨ 118.

For further information on Bluetooth settings, refer to (NAVI 50) "Bluetooth music" ⇨ 65 and "Bluetooth connection" in the "Phone" section ⇨ 127.

System

Select **System** to display the following options:

- **Language**
Change display language and voice instruction language for Navigation system. Press **OK** to confirm selection.
- **Clock/units**
The following settings can be changed:
 - **Time Format** (12h/24h)
 - **Units** (km/mils)
 - **Time Setting**
Press ► to open the **Time set** submenu containing the following options:
Auto/Manual
If Auto time setting is selected, the time is set automatically by GPS.

If Manual time setting is selected, adjust as appropriate.

Note

Navigation maps for the current country must be installed on the system to ensure the local time is correct.

• Factory settings

The following settings can be reset to the factory default:

- **All**
- **Phone**
- **Navigation**
- **Audio-Media-Radio-System**
- **Navigation (On/Off)**
- **System version** (displays Infotainment system software version number)

When system setting adjustments have been made, press ⏠ (and select another menu on the display) to exit the settings menu and save changes. The system also saves and exits automatically after a delay.

NAVI 80 - System settings

To access the system settings menu from the Home page, press **MENU** followed by **System** on the display screen.

The following settings submenus are displayed:

- **Language**
- **Display**
- **Sound**
- **Clock**
- **Safety warnings**
- **Home screen**
- **Keyboards**
- **Set units**
- **Status & Information**
- **Remove SD-card**
- **Restore factory settings**

After system settings are changed, press **Done** to confirm.

Language

To change Infotainment system language then voice type.

Display

The following settings are displayed:

- **Daytime brightness:** Change screen brightness to suit external light levels (daylight).

During low external light levels, the display screen is easier to view when the display is not too bright.

- **Night brightness:** Change screen brightness to suit external light levels (night light).

During low external light levels, the display screen is easier to view when the display is not too bright.

- **Switch to night mode at night:** To activate automatic switching between daytime/night brightness.

Night mode is activated during low external light levels and when the headlights are switched on.

- **Use night mode:** To activate night mode.

Sound

The following settings submenus are displayed:

- **Sound levels:** To change volume and sounds for traffic information, handsfree phone system, phone ringtone, application alerts, system voice and navigation instructions.
- **Alerts:** To adjust alert volume, and switch on/off alerts when display screen is switched off.
- **Speed sensitivity:** To set volume adjustment based on vehicle speed.
- **Computer voice:** Adjust types of information to be given by the Infotainment system voice.
- **Voice:** Change the voice used by the Infotainment system.

Clock

To set the system clock and the time display format.

Keeping the automatic time setting switched on is recommended.

Safety warnings

To switch on/off various alerts provided by the Infotainment system. Check appropriate boxes to switch on.

Home screen

To change the home page configuration.

Select from list of options to see a preview of each home page layout.

Keyboards

To change first the alphabet type (e.g. Greek) then the keyboard type (e.g. Qwerty).

Set units

To change the units of measurement, for e.g. distance, co-ordinates, temperature and barometric units.

Status & Information

To display system information, e.g. version, GPS status, network status, licences and copyright information.

Remove SD-card

To eject the SD card safely.

Restore factory settings

To delete all Infotainment system information. Follow the instructions on the display.

Note

Afterwards, the Infotainment system will restart in English by default. If necessary, select **Language** in the **System** menu to change language.

Multimedia settings

To access the Multimedia settings menu from the Home page, press **MENU** then **Multimedia**, followed by **Settings** on the display screen.

The following settings submenus are displayed:

- **Sound**
- **Radio**
- **Media**
- **Pictures**
- **Video**

After settings have been changed, press **Done** to confirm.

Sound

The following sound settings can be updated:

- 'Spatialisation':
Set the sound distribution in the vehicle.
- 'Ambience':
Set the sound option, e.g. 'Pop-rock', 'Classical', 'Jazz', 'Neutral'. Select 'Manual' to manually set the treble and bass levels.
Press **Confirm** to save changes.
- 'Demo arkamys':
Select to trial Arkamys mode.
- 'Bass Boost Arkamys':
Switch bass amplification on/off.

Radio

The following radio settings can be updated:

- switch searching for Alternative Frequencies (AF) on/off
- switch i-traffic on/off
- switch programme type on/off
- update list of saved radio stations

For further information, refer to (NAVI 80) "Radio" ⇨ 45.

Media

The following media settings can be updated:

- track repeat: Switch on/off
- shuffle: Switch on/off
- album image display: Switch on/off
- bluetooth connection: Configure

For further information, refer to (NAVI 80) "Bluetooth music" ⇨ 65.

Pictures

The following photo settings can be updated:

- set display time for photos during a slideshow
- set transition effects between photos in a slideshow
- switch from normal to full screen display

For further information, refer to "Displaying pictures" ⇨ 72.

Video

The following video settings can be updated:

- set display type for videos
- switch from normal to full screen display

For further information, refer to "Playing movies" ⇨ 72.

Radio

Usage	45
Station search	47
Autostore lists	50
Radio data system (RDS)	51
Digital audio broadcasting	54

Usage

Radio reception

Radio reception may be disrupted by static, noise, distortion or loss of reception due to:

- changes in distance from the transmitter
- multi-path reception due to reflection
- shadowing

R15 BT USB, R16 BT USB, CD16 BT USB, CD18 BT USB - Controls

The most important buttons for control of the radio are:

- **RADIO**: Activate radio, change waveband
- **◀▶**: Station search
- **OK**: Change frequency
- Station buttons 1...6: Preset station buttons

- **SETUP**: System settings, automatic station storing
- **TEXT**: Display radio text information

Activating the radio

Press **RADIO** to switch the audio source to radio.

The station previously selected will be received.

Selecting the waveband

Press **RADIO** repeatedly to switch between the available wavebands (e.g. FM1, FM2, AM).

The station previously selected in that waveband will be received.

CD35 BT USB - Controls

The most important buttons for control of the radio are:

- **RADIO**: Activate radio, change waveband
- **◀▶**: Change frequency, station search
- Central rotary knob: Access stored radio station list

- Station buttons 1...6: Preset station buttons
- **SETUP / TEXT**: System settings

Activating the radio

Press **RADIO** to switch the audio source to radio.

The station previously selected will be received.

Selecting the waveband

Press **RADIO** repeatedly to switch between the available wavebands (e.g. FM1, FM2, MW, LW).

The station previously selected in that waveband will be received.

NAVI 50 - Controls

Use the touchscreen to operate the radio.

The main controls are:

- **FM/AM/DAB** (depending on version): Press ▼ and switch between FM and AM wavebands.
- ◀▶: Press to start automatic search for next/previous radio station.
- ◀▶: Press to change to next/previous frequency in increments of 0.5.

Activating the radio

To activate the radio at any time, press ⬆ followed by  **Radio** on the display screen. The station previously selected will be received.

The following submenus are displayed:

- **Main**: Radio station/frequency is displayed.
- **List**: Displays an alphabetical list of available radio stations (maximum 50 stations).

Note

Radio stations without RDS: Only the frequency is displayed. These stations appear at the end of the list.

- **Preset**: Displays stored favourite radio stations.

Options:

The following settings can be changed, depending on selected waveband:

- **RDS** (On/Off)
- **TA** (On/Off)
- **Region** (On/Off)
- **News** (On/Off)
- **AM** (On/Off)
- **Update list** (On/Off)

For further information, refer to (NAVI 50) "Radio data system (RDS)"  51.

Selecting the waveband

Press ▼ alongside **FM/AM/DAB** (if available) in the top left corner of the display and select FM, AM or DAB waveband.

The station previously selected in that waveband will be received.

Note

AM waveband can be switched off via the **Options** menu.

Refer to "Digital audio broadcasting" ⇨ 54.

NAVI 80 - Controls

Use the touchscreen to operate the radio.

The main controls are:

- **FM/AM:** Press tab in top left corner of the display and switch between FM and AM wavebands.
- **<>:** Press to start automatic search for next/previous radio station.
- **</>:** Press to change to next/previous frequency in increments of 0.1 MHz.
- **⌂/📶:** Press to scroll through a list of stations.

Activating the radio

To access the Radio from the Home page, press **MENU** then **Multimedia**, followed by **Radio** on the display screen.

The following modes are available:

- **Preset:**
Displays stored favourite radio stations.
- **List:**
Displays an alphabetical list of available radio stations (maximum 50 stations).

Note

Radio stations without RDS: Only the frequency is displayed. These stations appear at the end of the list.

- **Frequency:**
Search manually or automatically by scanning the selected range of frequencies.

Selecting the waveband

Press **FM/AM** tab in top left corner of the display and switch between wavebands.

The station previously selected in that waveband will be received.

Station search**Automatic station search****R15 BT USB, R16 BT USB, CD16 BT USB, CD18 BT USB - Automatic station search**

Briefly press **⏪** or **⏩** to search for the next receivable station in the current waveband.

If no station is found, automatic searching continues until **⏪** or **⏩** is pressed again.

CD35 BT USB - Automatic station search

Press **⏪** or **⏩** for approx. 2 seconds to search for the next receivable station in the current waveband.

If no station is found, automatic searching continues until **⏪** or **⏩** is pressed again.

NAVI 50 - Automatic station search

Press **⏪** or **⏩** in the display to search for the next receivable station in the current waveband.

If no station is found, automatic searching continues until ◀ or ▶ is pressed again.

NAVI 80 - Automatic station search

Press ◀ or ▶ in the display to search for the next receivable station in the current waveband.

If no station is found, automatic searching continues until ◀ or ▶ is pressed again.

Manual station search

R15 BT USB, R16 BT USB, CD16 BT USB, CD18 BT USB - Manual station search

Select the desired waveband then press and hold ◀◀ or ▶▶ to scan the selected waveband.

Release the button when close to the required frequency. An automatic search is then made for the next receivable station and it is played automatically.

Turn **OK** to change the frequency in increments.

Stored station search

This allows you to recall radio stations that you have previously stored.

To store a station, select the desired waveband and station then press station button 1...6 until an audible signal sounds, confirming that the station has been stored to the appropriate station button. 6 stations per waveband can be stored.

Recalling a stored station

To recall a station, select the desired waveband then briefly press station button 1...6.

Search radio station name (FM only)

Select the FM waveband then highlight the station name in the display using ◀ or ▶.

Press $\frac{1}{2}$ or $\frac{1}{3}$ repeatedly to manually search for the required station name. The frequency may be displayed instead if the station name is unavailable.

The alphabetical list contains up to 60 FM radio stations with the best reception. This list can be updated at any time. Autostore lists ⇄ 50.

CD35 BT USB - Manual station search

Select the desired waveband then press and hold ◀◀ or ▶▶ to scan the selected waveband.

Release the button when close to the required frequency. An automatic search is then made for the next receivable station and it is played automatically.

Press ◀◀ or ▶▶ briefly to change the frequency in increments.

Stored station search

This allows you to recall radio stations that you have previously stored.

To store a station, select the desired waveband and station then press station button 1...6 until an audible signal sounds, confirming that the station has been stored to the appropriate station button. 6 stations per waveband can be stored.

Recalling a stored station

To recall a station, select the desired waveband then briefly press station button 1...6.

Search radio station name (FM only)

Select the FM waveband and open the FM radio station list by turning the central rotary knob.

Turn the knob to manually search for the required station name and press the knob to select.

The alphabetical list contains up to 50 FM radio stations with the best reception. This list can be updated at any time. Autostore lists ⇨ 50.

NAVI 50 - Manual station search

Select the desired waveband then press ◀ or ▶ to change to next/previous frequency in increments of 0.5.

Stored station search

This allows you to recall radio stations that you have previously stored.

To store a station, select the desired waveband and station then press **Preset** to display the stored favourites.

Press and hold on the desired location. The frequency or name of the radio station appears on the

favourite location, confirming that the station has been stored (📌 indicates the currently received station).

Note

12 stations per waveband can be stored.

Recalling a stored station

To recall a station, select the desired waveband then press **Preset** to display the stored favourites. Briefly press the desired favourite radio station.

Press ◀/▶ to move to the previous/next page of favourites.

Search radio station name (FM and DAB only)

Select waveband FM or DAB (if available) then press **List** to display an alphabetical list of available radio stations.

Press ▼ or ▲ to manually search for the required station name. The frequency may be displayed instead if the station name is unavailable. Press a list item to receive the selected station (📌 indicates the currently received station).

The alphabetical list contains up to 50 radio stations with the best reception. This list can be updated at any time, refer to "Autostore lists" ⇨ 50.

NAVI 80 - Manual station search

Select the desired waveband then press < or > to change to next/previous frequency in increments of 0.1 MHz.

Stored station search

This allows you to recall radio stations that you have previously stored.

To store a station, select the desired waveband and station then press **Preset** to display the stored favourites.

Press and hold on the desired location until a beep is heard. The frequency or name of the radio station appears on the favourite location, confirming that the station has been stored. 6 stations per waveband can be stored.

Alternatively, select the desired waveband and station then press **Frequency** or **List**. Press + to open a pop-up menu, then select **Save as preset**.

Recalling a stored station

To recall a station, select the desired waveband then press **Preset** to display the stored favourites. Briefly press the desired favourite radio station.

Search radio station name (FM only)

Select the FM waveband then press **List** to display an alphabetical list of available radio stations.

Press $\frac{1}{2}$ or $\frac{3}{4}$ to manually search for the required station name. The frequency may be displayed instead if the station name is unavailable.

The alphabetical list contains up to 50 radio stations with the best reception. This list can be updated at any time, refer to "Autostore lists" \hookrightarrow 50.

Autostore lists

The stations with the best reception in a waveband can be searched for and stored automatically via the autostore function.

Automatic station storing

R15 BT USB, R16 BT USB, CD16 BT USB, CD18 BT USB - Automatic station storing

The FM waveband has an autostore list (AST), on which 6 stations can be stored.

While listening to the radio, press and hold **SETUP**: The 6 stations with the strongest reception will be automatically stored on AST.

Note

Due to signal strength, it is possible that less than 6 stations will be stored.

CD35 BT USB - Automatic station storing

Depending on vehicle, up to 50 radio stations are continually updated and stored automatically by the system.

Recalling a station

R15 BT USB, R16 BT USB, CD16 BT USB, CD18 BT USB - Recalling a station

Select the desired waveband, then briefly press station button 1...6 to recall a stored station.

To recall a station on the autostore list (AST), while listening to the radio briefly press **SETUP** to activate AST mode. The station previously selected will be received. Briefly press station button 1...6 to recall another stored station on the autostore list.

CD35 BT USB - Recalling a station

Select the desired waveband, then briefly press station button 1...6 to recall a stored station.

Alternatively, select the FM waveband and open the FM radio station list by turning the central rotary knob. Turn the knob to manually search for the required station name and press the knob to select.

Updating stations list manually

Stations can also be stored manually in the autostore list.

Note

Only available with CD35 BT USB, NAVI 50, NAVI 80.

To update the list of stations and obtain the most recent ones, activate the system update manually. Depending on Infotainment system, the sound may be muted during a manual update.

CD35 BT USB - Updating stations list manually

Press **SETUP / TEXT** and turn the central rotary knob to access **Radio functions**.

Turn the rotary knob to select **Update FM list** and press to confirm update.

NAVI 50 - Updating stations list manually

Press **Options**, scroll down to **Update List** then select **Start; Updating ...** appears on the display until the update is complete.

Note

If DAB is available, it is recommended to update the DAB stations list manually when the system is switched on.

NAVI 80 - Updating stations list manually

From the Home page, press **MENU** then **Multimedia**, followed by **Radio** on the display screen.

Select any the following modes:

- **Preset**
- **List**
- **Frequency**

Press **+** to open a pop-up menu, then select **Update radio list**.

Radio data system (RDS)

RDS is an FM station service that helps you find the desired station and ensures its fault-free reception.

Advantages of RDS

- The programme name of the chosen station appears on the display screen instead of its frequency.
- During an automatic station search, the Infotainment system tunes into RDS stations only.
- The Infotainment system always tunes into the best receivable broadcasting frequency of the chosen station, by means of AF (Alternative Frequency).

R15 BT USB, R16 BT USB, CD16 BT USB, CD18 BT USB - RDS functions

Configuring RDS

Press **SETUP** and turn **OK** to access the **RDS** menu. Press knob to select.

Turn the rotary knob to select **RDS SETUP**.

Switching RDS on and off

Press **Options** on the display screen. The following settings can be changed:

Switch on/off **RDS-AF** by pressing **OK**. **AF** is shown on the display screen when RDS is active.

Text information (Radio text)

Certain FM radio stations issue text information relating to the broadcast program (e.g. song name).

Press **SETUP** and turn **OK** to access the **Radio texts** menu.

Turn the rotary knob to select **Radio** and press the knob to see this information.

CD35 BT USB - RDS functions

Configuring RDS

Press **SETUP / TEXT** and turn the central rotary knob to access the **Radio functions** menu. Press knob to select.

Turn the rotary knob to select **RDS-AF**.

Switching RDS on and off

Switch on/off **RDS-AF** by pressing the central rotary knob.

I-Traffic service (Traffic information)

Radio traffic service stations are FM RDS stations that broadcast traffic news.

Switching the I-Traffic service on and off

To switch the traffic announcement on and off:

Press **SETUP / TEXT** and turn the central rotary knob to access the **Radio functions** menu. Press knob to select.

Turn the rotary knob to select **i Traffic** and switch on/off by pressing the knob.

- If the radio traffic service is switched on, CD/MP3 playback is interrupted for the duration of the traffic announcement.
- Traffic announcements will not be broadcast automatically when the LW or MW waveband is selected. Change the audio source or waveband to FM to ensure traffic announcements are broadcast automatically.

Blocking out traffic announcements

To block out a traffic announcement e.g. during CD/MP3 playback: Press the central rotary knob (or \rightarrow).

The traffic announcement is interrupted, but the radio traffic service remains switched on.

Text information (Radio text)

Certain FM radio stations issue text information relating to the broadcast program (e.g. song name).

Press and hold **SETUP / TEXT** to see this information.

Press \rightarrow or wait for 30 seconds to return to the original display screen.

NAVI 50 - RDS functions

Configuring RDS

Press **Options** on the display screen. The following settings can be changed:

- **RDS** (On/Off)
Switch off if not required.
- **TA** (On/Off)
See below.

- **Region/AF** (On/Off)
See below.
- **News** (On/Off)
See below.
- **AM** (On/Off)
Switch off if not required.
- **Update list** (On/Off)
Refer to (NAVI 50) "Autostore lists" ⇨ 50.

TA (Traffic announcements)

If **TA** is switched on:

- Traffic announcements from certain FM radio stations (and DAB stations, if available) are broadcast automatically.
- Radio and auxiliary audio source playback is interrupted for the duration of the traffic announcement.

Note

Automatic broadcasting of traffic announcements is deactivated if waveband is set to **AM**.

Region/AF

If the RDS function is activated and **Region/AF** is switched on:

The frequency of certain FM radio stations may change depending on the geographical area.

Poor reception can sometimes cause erratic and unwelcome changes in frequency. Switch off **Region/AF** if necessary.

News

If **News** is switched on:

- News announcements from certain FM radio stations (and DAB stations, if available) are broadcast automatically.
- Radio and auxiliary audio source playback is interrupted for the duration of the traffic announcement.

Text information (Radio text)

Certain FM radio stations (and DAB stations, if available) issue text information relating to the broadcast program (e.g. song name).

NAVI 80 - RDS functions

Configuring RDS

To access the Radio settings menu from the Home page, press **MENU** then **Multimedia**, followed by **Settings** then **Radio** on the display screen.

Press **+** to open a pop-up menu, and access the 'Radio settings' option.

The following radio settings can be updated:

- switch searching for alternative frequencies (AF) on/off
- switch I-Traffic on/off
- switch programme type on/off
- update list of saved radio stations

Alternative Frequency (AF)

Switch on the RDS-AF function to always tune into the best receivable broadcasting frequency of the chosen station

Poor reception can sometimes cause erratic and unwelcome changes in frequency. Switch off RDS-AF function if necessary.

I-Traffic (Traffic information)

Radio traffic service stations are FM RDS stations that broadcast traffic news.

Switch on I-Traffic to automatically receive traffic bulletins when they are broadcast.

Programme type search (PtY)

Switch on PtY to display the type of programme (e.g. news, sport) currently being broadcast

Update radio list

Refer to (NAVI 80) "Autostore lists" ⇨ 50.

Text information (Radio text)

Certain FM radio stations issue text information relating to the broadcast program (e.g. song name).

To check for text information, from any radio mode (e.g. **Preset**, **List**, **Frequency**) press **+** to open a pop-up menu, and access the text information option.

Digital audio broadcasting

Digital audio broadcasting (DAB) is an innovative and universal broadcast system.

General information

- DAB stations are indicated by the programme name instead of the broadcasting frequency.
- With DAB, several radio programmes (services) can be broadcast on a single frequency (ensemble).
- Besides high-quality digital audio services, DAB is also able to transmit programme-associated data and a multitude of other data services including travel and traffic information.
- As long as a given DAB receiver can pick up the signal sent out by a broadcasting station (even if the signal is very weak), sound reproduction is ensured.
- There is no fading (weakening of the sound) that is typical of AM or FM reception. The DAB signal is reproduced at a constant volume.

- Interference caused by stations that are on nearby frequencies (a phenomenon that is typical of AM and FM reception) does not occur with DAB.

If the DAB signal is too weak to be picked up by the receiver, the system switches over to the same programme on another DAB or FM station.

- If the DAB signal is reflected by natural obstacles or buildings, the reception quality of DAB is improved, whereas AM or FM reception is considerably impaired in such cases.
- When DAB reception is enabled, the FM tuner of the Infotainment system remains active in the background and continually searches for the best receivable FM stations.

CD Player

General information	55
Usage	56

General information

The Infotainment system's CD player can playback audio CDs, MP3 CDs and also WMA CDs.

CD16 BT, CD18 BT: AAC and WAV formats can also be played.

Important information about audio CDs and MP3/WMA CDs

Caution

Under no circumstances place DVDs, single-CDs with a diameter of 8 cm or shaped CDs in the audio player.

You must not put any stickers on CDs. These discs can get jammed in the CD drive and ruin the drive. An expensive replacement of the device will then be necessary.

- Audio CDs with copy protection, which are not in compliance with the audio CD standard, may not play correctly or not at all.

- Self-recorded CD-Rs and CD-RWs and WMA files with Digital Rights Management (DRM) from online music shops may not play correctly or not at all.
- On mixed mode CDs (combinations of audio and data, e.g. MP3), only the audio tracks will be detected and played.
- Self-recorded CD-Rs and CD-RWs are more vulnerable to mishandling than prerecorded CDs. Correct handling, especially in the case of self-recorded CD-Rs and CD-RWs, must be ensured; see below.
- Avoid leaving fingerprints when you change CDs.
- Put CDs back in their sleeves immediately after removing them from the CD player, in order to protect them from dirt and damage.
- Dirt and liquids on CDs can smear the lens of the audio player inside the device and cause faults.

- Protect CDs from heat and direct sunlight.
- The following restrictions apply for MP3/WMA CDs:
 - Only MP3 files and WMA files can be read.
 - Maximum folder structure depth: 11 levels
 - Maximum number of MP3 and/or WMA files that can be saved: 1000 files
 - Applicable playlist extensions: .m3u, .pls
 - Playlist entries must be in the form of relative paths.
- The operation of MP3 and WMA files is identical. When a CD with WMA files is loaded, MP3-related menus are displayed.

Usage

CD16 BT USB, CD18 BT USB - CD player usage

Starting CD playback

Switch on the Infotainment system (by pressing \odot) and push the CD with the printed side up into the CD slot until it is pulled in: CD playback starts automatically.

If there is already a CD in the unit, press **MEDIA** repeatedly to select the desired audio source: CD playback is started.

Note

Depending on the data stored on the audio CD or MP3 CD, differing information about the CD and the current music track will be shown on the display.

Selecting an album or track

Turn **OK** to select an album or track from the list.

Skipping to the next track or previous track

Briefly press \lll or \ggg once or several times.

Fast forward or rewind

Press and hold \lll or \ggg to fast forward or rewind the current track.

Random playback

During CD playback, press and hold the numbered button **2** or **4** (from the Station buttons 1...6) to activate random playback.

MIX appears on the display when random playback is active.

Note

On an MP3 CD, the random playback function applies only to the current album.

Press and hold the numbered button **2** or **4** again to deactivate.

MIX disappears from the display.

Random playback can also be deactivated by ejecting the CD.

Note

Random playback is not deactivated when the audio system is switched off or the source changed.

Pause

Briefly press \odot , \otimes or both \blacktriangleleft and \blacktriangleright simultaneously to interrupt CD/MP3 CD playback. Press again to resume playback.

The pause function is deactivated automatically when the volume is adjusted, the audio source is changed or automatic information messages are issued.

Displaying additional text information (CD-Text or ID3 tag)

After selecting a track or album, briefly press **TEXT** or numbered button **5** (from the Station buttons 1...6) to access the text information available on the CD (e.g. artist name, album name or song name).

To display all text information at once, press and hold numbered button **5** or **TEXT**.

To exit the display, press \rightarrow .

Removing a CD

Press \triangle : The CD is pushed out of the CD slot.

If the CD is not removed after ejection, it will be drawn back in again automatically after a few seconds.

CD35 BT - CD player usage

Starting CD playback

Switch on the Infotainment system (by pressing \odot) and push the CD with the printed side up into the CD slot until it is pulled in: CD playback starts automatically.

If there is already a CD in the unit, press **MEDIA** repeatedly to select the desired audio source: CD playback is started.

Note

Depending on the data stored on the audio CD or MP3 CD, differing information about the CD and the current music track will be shown on the display.

Selecting an album or track

Turn the central rotary knob to select an album or track from the list.

Skipping to the next track or previous track

Briefly press \blacktriangleleft or \blacktriangleright once or several times.

Fast forward or rewind

Press and hold \blacktriangleleft or \blacktriangleright to fast forward or rewind the current track.

Random playback

Press **SETUP / TEXT** to access the settings menu.

Turn the central rotary knob to select **Audio settings** and press knob to confirm.

Select **Random** and press the knob to activate.

Note

On a CD MP3/WMA, the random playback function applies to the current album, then moves on to the next album.

Pause

Briefly press the volume rotary knob, \otimes or both \blacktriangleleft and \blacktriangleright simultaneously to interrupt CD/MP3 CD playback. Press again to resume playback.

The pause function is deactivated automatically when the volume is adjusted, the audio source is changed or automatic information messages are issued.

Displaying additional text information (CD-Text or ID3 tag)

After selecting a track or album, press and hold the central rotary knob to access the text information available on the CD (e.g. artist name, album name or song name).

To exit the display, press →.

Removing a CD

Press ▲: The CD is pushed out of the CD slot.

If the CD is not removed after ejection, it will be drawn back in again automatically after a few seconds.

AUX input

General information	59
Usage	59

General information

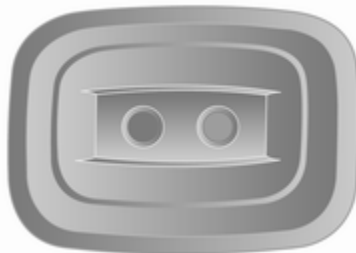

An AUX socket is available for the connection of external audio sources.

Note

The socket must always be kept clean and dry.

It is possible, for example, to connect a portable CD player with a 3.5 mm jack plug to the AUX input.

Usage

An audio source that is connected to the AUX input can only be operated via the controls on the audio source, i.e. not via the Infotainment system.

Only select a track directly on the audio source when the vehicle is stationary.

Caution

Before connecting or disconnecting an auxiliary device, e.g. a portable CD player, switch off the player and the Infotainment system, to avoid sound quality issues and possible damage to the equipment.

Upon connection via the jack plug, the system detects the audio source automatically. Depending on the recording volume, there may be a delay before the audio source is heard.

The artist or track name are not shown on the display screen.

Note

Ensure the auxiliary device is securely stowed during driving. Vehicle occupants could be injured by objects being thrown around in the event of hard braking, a sudden change in direction or an accident.

R15 BT USB, R16 BT USB, CD16 BT USB, CD18 BT USB- AUX input usage

Press **MEDIA** or **AUDIO/SOURCE** to change the audio source to AUX mode, then switch on the auxiliary device. AUX appears on the display screen.

AUX settings

Press **SETUP** to access the settings menu.

Select AUX IN and turn **OK** until the desired setting is selected from:

- HI (300 mV)
- MID (600 mV)
- LO (1200 mV)

CD35 BT USB - AUX input usage

Press **MEDIA** to activate the AUX mode, then switch on the auxiliary device. Jack appears on the display screen.

NAVI 50 - AUX input usage

To access the media menu at any time, press **⬆** followed by **🎵**/**🎧** **MEDIA** on the display screen.

To switch between auxiliary sources, press **▼** in top left corner. The following options are available:

- **USB:** Refer to (NAVI 50) "USB port" ⇨ 61.
- **iPod:** Refer to (NAVI 50) "USB port" ⇨ 61.
- **BT:** Refer to (NAVI 50) "Bluetooth music" ⇨ 65.
- **Aha:** Aha® application for smartphones (available depending on version).
Refer to "Usage", Additional features (NAVI 50) in the "Introduction" section ⇨ 24.
- **AUX:** Select to change the audio source to AUX mode, then switch on the auxiliary device.

NAVI 80 - AUX input usage

Change the audio source to AUX mode to playback content from a connected auxiliary device.

To access the media menu from the Home page, press **MENU** then **Multimedia**, followed by **Media** on the display screen.

Press **+** to open a pop-up menu. The following options are available:

- **Auxiliary socket:** Change the audio source to AUX mode, then switch on the auxiliary device.
- **USB:** Refer to (NAVI 80) "USB port" ⇨ 61
- **Bluetooth connection:** Refer to (NAVI 80) "Bluetooth music" ⇨ 65
- **SD card**
- **CD player**

USB port

General information 61
Playing saved audio files 62

General information

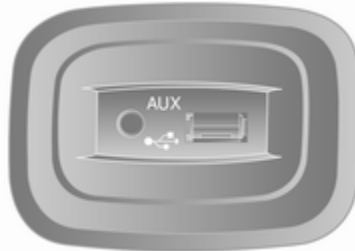

In the Infotainment unit (or in the centre console) there is a USB socket for the connection of external audio sources.

Note

The socket must always be kept clean and dry.

An MP3 player, USB drive or an iPod can be connected to the USB port.

These devices are operated via the controls and menus of the Infotainment system.

Important information

MP3 player and USB drives

- The MP3 players and USB drives connected must comply with the USB Mass Storage Class specification (USB MSC).
- Only MP3 players and USB drives with a sector size of 512 Bytes and a cluster size smaller or equal to 32 kBytes in the FAT32 file system are supported.
- Hard disk drives (HDD) are not supported.
- The following restrictions apply for the data stored on an MP3 Player or USB device:

Only MP3 files, WMA and (depending on Infotainment system) ACC files can be read. WAV files and all other compressed files cannot be played.

Maximum folder structure depth: 11 levels.

Maximum number of files that can be saved: 1000 files.

NAVI 50: Minimum recommended storage capacity of USB drive is 4 GB.

Recommended maximum storage capacity is 32 GB.

WMA files with Digital Rights Management (DRM) from online music shops may not play correctly or not at all.

Applicable playlist extensions: .m3u, .pls.

Playlist entries must be in the form of relative paths.

Playing saved audio files

Once connected, it is only possible to use the controls and menus of the Infotainment system to operate the audio device.

R15 BT USB, R16 BT USB, CD16 BT USB, CD18 BT USB - Playing music via USB socket

MP3 player / iPod / USB drives

The system detects the audio device when a USB device is connected and the current track is displayed automatically.

When a new audio device is connected, the first track in the first folder is played automatically. When reconnecting the device, the previously played track is resumed.

Depending on the audio device connected, select a folder (MP3 player, USB drive) or a playlist (portable digital music player).

The operation of data sources connected via USB is generally the same as for an audio/MP3/WMA CD ↻ 56.

Selecting a track

To select tracks directly (and change folders), first access the audio device menu structure by pressing OK during playback. Select tracks and change folders by turning and pressing the knob.

CD35 BT USB - Playing music via USB socket

MP3 player / iPod / USB drives

The system detects the audio device when a USB device is connected and the first track in the first folder is

played automatically. When reconnecting the device, the previously played track is resumed.

Depending on the audio device connected, select a folder (MP3 player, USB drive) or a playlist (portable digital music player).

The operation of data sources connected via USB is generally the same as for an audio/MP3/WMA CD ↻ 56.

Selecting a track

To select tracks directly (and change folders), first access the audio device menu structure by pressing the central rotary knob during playback (with iPod, turn the knob to access menu). Select tracks and change folders by turning and pressing the knob.

NAVI 50 - Playing music via USB socket

MP3 player / USB drives / iPod

The system detects the audio device when a USB device is connected and the current track is displayed automatically. The device type (MP3

player/USB drive or iPod) is also recognised and the relevant audio source mode (USB or iPod) is selected automatically.

When the /MEDIA menu is active, the following submenus are available:

- **Main/Player**
- **List**
- **Options**

To switch between audio sources, press  in top left corner. The following options are available:

- **USB:** Select to change the audio source to USB mode.

Note

During use, the battery of a connected USB device is charged or maintained.



- **iPod:** Select to change the audio source to iPod mode.
- **BT:** Refer to NAVI 50 "Bluetooth music" - ⇨ 65.
- **Aha:** Aha® application for smartphones (available depending on version).

Refer to "Usage", Additional features (NAVI 50) in the "Introduction" section ⇨ 24.

- **AUX:** Refer to NAVI 50 - "Aux input usage" ⇨ 59.

Main/Player

Press to display the current track. In this display screen, the following options are available:

-  (press to skip to previous track, press and hold to fast rewind)
-  (press to pause/play)
-  (press to skip to next track, press and hold to fast forward)

List

Displays a list of the tracks in the current album/folder. Press a particular track to play it directly.

Note

By default, albums are listed in alphabetical order.

If a USB drive is connected, all the folders will be at the same level on the tree structure.

To return to the previous level on the folder tree structure, press .

Options

Press to display the following options:

- **Repeat** (Off/Track/Folder/All)
- **Shuffle** (On/Off)

NAVI 80 - Playing music via USB socket

MP3 player / USB drives

Change the audio source to USB mode to playback files from a connected USB device.

To access the media menu from the Home page, press **MENU** then **Multimedia**, followed by **Media** on the display screen.

Press  to open a pop-up menu. The following options are available:

- **USB:** Change the audio source to USB mode.
- **Auxiliary socket:** Refer to NAVI 80 "AUX input" ⇨ 59.
- **Bluetooth connection:** Refer to NAVI 80 "Bluetooth music" ⇨ 65.
- **SD card**
- **CD player:** Refer to NAVI 80 "AUX input" ⇨ 59.

When USB mode is selected, the display includes the following options:

- **◀◀** or **▶▶**: Move to previous/next track.
- **⏸**: Pause track.
- Scroll bar for time elapsed: Scroll through tracks.
- **New selection**: Choose another track from the connected audio source.
- **Current playlist**: Access the current playback list.
- **←**: Return to previous screen.
- **+**: Open pop-up menu; To change the audio source or access the track settings (e.g. switch on/off shuffle or repeat, show current track details, and access sound settings).

Disconnecting from USB socket

Playback is stopped immediately when the audio device is withdrawn from the USB socket.

Bluetooth music

General information	65
Operation	65

General information

Bluetooth-enabled auxiliary audio sources (e.g. music mobile phones, MP3 players etc.), which support Bluetooth music protocol A2DP, can be connected wirelessly to the Infotainment system.

Important information

- The Infotainment system only connects to Bluetooth devices that support A2DP (Advanced Audio Distribution Profile). Connection issues may arise with early versions.
- The Bluetooth device must support AVRCP (Audio Video Remote Control Profile) version 1.0 or higher. If the device does not support AVRCP, only the volume can be controlled via the Infotainment system.
- Before connecting the Bluetooth device to the Infotainment system, become acquainted with its operating instructions for Bluetooth functions.

Operation

Prerequisites

The following prerequisites must be met, in order to control a Bluetooth-enabled audio device via the Infotainment system:

- The Bluetooth function of the Infotainment system must be activated.
Refer to "Bluetooth connection" in the "Phone" section ↻ 127.
- The Bluetooth function of the Bluetooth-enabled auxiliary audio source must be activated (see audio device operating instructions).
- Dependent upon the audio source, it may be required to set that device to "visible" (see audio device operating instructions).
- The audio source must be paired and connected to the Infotainment system.

R15 BT USB, R16 BT USB, CD16 BT USB, CD18 BT USB - Playing music via Bluetooth

Bluetooth connection

A connection must be set up between the audio device and the Infotainment system via Bluetooth, i.e. the device must be paired to the vehicle before using it.

Refer to "Bluetooth connection" in the "Phone" section ↷ 127.

- A maximum of 5 audio devices can be paired and saved in the device list, but only one can be connected at a time.
- If the device has both audio player and telephone functions, both functions will be paired. Pairing a mobile phone ↷ 124.
- Phone functions will remain active while the audio player is in use, and audio playback will be suspended during phone use.

Pairing an auxiliary audio device to the Infotainment system

To pair the audio device, press **TEL** and select **Pair device** by turning and pressing **OK**. The **Ready to Pair** screen is displayed.

Then, on the audio device, search for Bluetooth equipment in the vicinity of the device.

Select **My Radio** (i.e. the name of the system) from the list on the audio device, then, if applicable, on the audio device keypad enter the pairing code shown on the Infotainment system display screen.

Note

If the audio device does not have a screen, enter the default pairing code on the device, then on the Infotainment system. Refer to the operating instructions for this default audio device pairing code, usually **0000**. Depending on the device, the pairing code may need to be entered in reverse order, i.e. on the Infotainment system first.

If pairing fails, the system returns to the previous menu and a corresponding message is displayed. Repeat procedure if necessary.

When pairing is completed, a confirmation message followed by the name of the paired audio device is shown on the Infotainment system display screen.

Note

When a Bluetooth connection is active, controlling the audio device via the Infotainment system will discharge the audio device battery more rapidly.

Connecting an audio device

Audio devices are automatically connected to the Infotainment system after the pairing procedure is completed.

To connect any audio device that has been paired, or to connect to a different paired audio device than the current one, press **TEL** and select the **Select Device** menu. The device list shows the audio devices already paired.

Select the desired device from the list and confirm by pressing **OK**. A display message confirms connection.

Disconnecting an audio device

To disconnect an audio device from the Infotainment system, press **TEL** (or **SETUP**) and select **Bluetooth connection**. Select the desired device from the device list then select **Disconnect the device** by turning and pressing **OK**. A display message confirms disconnection.

Switching off the audio device or deactivating the Bluetooth function on the audio device also disconnects the device from the Infotainment system.

Unpairing an auxiliary audio device from the Infotainment system

If the list of paired audio devices is full, a new device can only be paired if an existing device is unpaired.

To unpair, i.e. to delete an audio device from the system memory, press **TEL** and select **Delete device**. Select the desired audio device from the list and press **OK** to confirm deletion when prompted.

Operation via Infotainment system

When paired and connected wirelessly, audio playback begins automatically.

The audio device can then be operated via the Infotainment system function buttons, rotary knobs and display menus.

The range of accessible functions that can be operated via the Infotainment system depends on the type of audio player.

The operation of the audio device when connected wirelessly is similar to the operations for the CD player ↷ 56.

CD35 BT USB - Playing music via Bluetooth

Bluetooth connection

A connection must be set up between the audio device and the Infotainment system via Bluetooth, i.e. the device must be paired to the vehicle before using it.

Refer to (CD35 BT USB) "Bluetooth connection" in the "Phone" section ↷ 127.

- A maximum of 5 audio devices can be paired and saved in the device list, but only one can be connected at a time.
- If the device has both audio player and telephone functions, one or both functions can be paired. Pairing a mobile phone ↷ 124.
- Phone functions will remain active while the audio player is in use, and audio playback will be suspended during phone use.

Pairing an auxiliary audio device to the Infotainment system

To pair the audio device, press **SETUP / TEXT** and select **Bluetooth connection**. Select an empty slot by turning the central rotary knob and press the knob to display the next menu.

Select **Pair device** by turning and pressing the rotary knob, then, on the audio device, search for Bluetooth equipment in the vicinity of the device.

Select **My_Radio** (i.e. the name of the system) from the list on the audio device, then, if applicable, on the

audio device keypad enter the pairing code shown on the Infotainment system display screen.

Note

If the audio device does not have a screen, enter the default pairing code on the device, then on the Infotainment system. Refer to the operating instructions for this default audio device pairing code, usually **0000**. Depending on the device, the pairing code may need to be entered in reverse order, i.e. on the Infotainment system first.

If pairing fails, the message **Pairing failed** is displayed. Repeat procedure if necessary.

When pairing is completed, a confirmation message followed by the name of the paired audio device is shown on the Infotainment system display screen.

Note

When a Bluetooth connection is active, controlling the audio device via the Infotainment system will discharge the audio device battery more rapidly.

Connecting an audio device

Audio devices are automatically connected to the Infotainment system after the pairing procedure is completed.

To connect any audio device that has been paired, or to connect to a different paired audio device than the current one, press **SETUP / TEXT** and select **Bluetooth connection** (or press **TEL** when no device is connected). The device list shows the audio devices already paired.

Select the desired device from the list and confirm by pressing the central rotary knob. A display message confirms connection.

Disconnecting an audio device

To disconnect an audio device from the Infotainment system, select the desired device from the **Bluetooth connection** menu then select **Disconnect the device** by turning and pressing the central rotary knob. A display message confirms disconnection.

Switching off the audio device or deactivating the Bluetooth function on the audio device also disconnects the device from the Infotainment system.

Unpairing an auxiliary audio device from the Infotainment system

If the list of paired audio devices is full, a new device can only be paired if an existing device is unpaired.

To unpair, i.e. to delete an audio device from the system memory, press **SETUP / TEXT** and select **Bluetooth connection**. Select the desired audio device from the list, press the central rotary knob and select **Delete**.

Operation via Infotainment system

When paired and connected wirelessly, audio playback begins automatically.

The audio device can then be operated via the Infotainment system function buttons, rotary knobs and display menus.

The range of accessible functions that can be operated via the Infotainment system depends on the type of audio player.

The operation of the audio device when connected wirelessly is similar to the operations for the CD player ⇨ 56.

NAVI 50 - Playing music via Bluetooth

Bluetooth connection

A connection must be set up between the audio device and the Infotainment system via Bluetooth, i.e. the device must be paired to the vehicle before using it.

Refer to (NAVI 50) "Bluetooth connection" in the "Phone" section ⇨ 127.

- A maximum of 5 audio devices can be paired and saved in the device list, but only one can be connected at a time (depending on version, up to 8 audio devices may be paired).

- If the device has both audio player and telephone functions, both functions will be paired. Pairing a mobile phone ⇨ 124.
- Phone functions will remain active while the audio player is in use, and audio playback will be suspended during phone use.

Pairing an auxiliary audio device to the Infotainment system

To pair the audio device, press  followed by  **SETTINGS** on the display screen.

Select **Bluetooth** then either **Search for Bluetooth device** or **External device authorisation**.

On the audio device, search for Bluetooth equipment in the vicinity of the device.

Select the name of the Infotainment system (e.g. **MEDIA-NAV**) from the list on the audio device, then (if required), on the audio device keypad, enter the pairing code shown on the Infotainment system display screen.

The default pairing code is **0000**. To change this pairing code before the pairing procedure is started, select **Change passkey** to update.

Note

If the audio device does not have a screen, enter the default pairing code on the device, then on the Infotainment system. Refer to the operating instructions for this default audio device pairing code, usually **0000**. Depending on the device, the pairing code may need to be entered in reverse order, i.e. on the Infotainment system first.

If pairing fails, repeat procedure if necessary.

Note

When a Bluetooth connection is active, controlling the audio device via the Infotainment system will discharge the audio device battery more rapidly.

Connecting an audio device

Audio devices are automatically connected to the Infotainment system after the pairing procedure is completed.

To change the audio device connected, press **⏠** followed by **⚙️SETTINGS** on the display screen.

Then select **Bluetooth** followed by **View Bluetooth device list**. The device list shows the audio devices already paired.

Select the desired audio device from the list and confirm by pressing **OK**.

Disconnecting an audio device

Switching off the audio device or deactivating the Bluetooth function on the audio device disconnects the device from the Infotainment system.

Unpairing an auxiliary audio device from the Infotainment system

If the list of paired audio devices is full, a new device can only be paired if an existing device is unpaired.

To unpair, i.e. to delete an audio device from the system memory, press **⏠** followed by **⚙️SETTINGS** on the display screen.

Select **Bluetooth** then **View Bluetooth device list**.

Select the desired audio device from the list, then press **⏏** to delete the device. If required, delete all devices in the list by pressing **Options** followed by **Delete all**. Confirm with **OK**.

Operation via Infotainment system

When paired and connected wirelessly, audio playback begins automatically.

The audio device can then be operated via the Infotainment system display options.

The range of accessible functions that can be operated via the Infotainment system depends on the type of audio player.

The operation of the audio device when connected wirelessly is similar to the operations for playing saved audio files via the USB socket. Refer to "NAVI 50 - Playing music via USB socket" in the "USB port" section ↻ 62.

NAVI 80 - Playing music via Bluetooth

Bluetooth connection

A connection must be set up between the audio device and the Infotainment system via Bluetooth, i.e. the device must be paired to the vehicle before using it.

- There is a maximum number of audio devices that can be paired and saved in the device list, but only one can be connected at a time.
- If the device has both audio player and telephone functions, both functions will be paired. Pairing a mobile phone ↻ 124.
- Phone functions will remain active while the audio player is in use, and audio playback will be suspended during phone use.

Pairing an auxiliary audio device to the Infotainment system

From the Home page, press **MENU** then **Multimedia**, followed by **Settings** on the display screen.

Select **Media** to access the media settings menu, then select the "Configure Bluetooth connection" option.

The pairing procedure is similar to pairing a mobile phone. Refer to (NAVI 80) "Bluetooth connection" in the "Phone" section ⇨ 127.

Connecting an audio device

Audio devices are automatically connected to the Infotainment system after the pairing procedure is completed.

At any time, change the audio source to Bluetooth mode to playback files from a connected Bluetooth device.

From the Home page, press **MENU** then **Multimedia**, followed by **Media** on the display screen.

Press **+** (to open a pop-up menu) and select **Bluetooth connection** to change the audio source to Bluetooth.

Disconnecting an audio device

Switching off the audio device or deactivating the Bluetooth function on the audio device disconnects the device from the Infotainment system.

Unpairing an auxiliary audio device from the Infotainment system

To unpair, i.e. to delete a device from the system memory:

From the Home page, press **MENU** then **Multimedia**, followed by **Settings** on the display screen.

Select **Media** to access the media settings menu, then select the "Configure Bluetooth connection" option.

The unpairing procedure is similar to pairing a mobile phone. Refer to (NAVI 80) "Bluetooth connection" in the "Phone" section ⇨ 127.

Operation via Infotainment system

When paired and connected wirelessly, audio playback may begin automatically.

The audio device can then be operated via the Infotainment system display options.

The range of accessible functions that can be operated via the Infotainment system depends on the type of audio player.

The operation of the audio device when connected wirelessly is similar to the operations for playing saved audio files via the USB socket. Refer to "NAVI 80 - Playing music via USB socket" in the "USB port" section ⇨ 62.

External devices

Displaying pictures	72
Playing movies	72

Displaying pictures

NAVI 80 - Displaying pictures

To access the "Pictures" menu from the Home page, press **MENU** then **Multimedia**, followed by **Pictures** on the display screen.

Select the connected source device (e.g. SD card, USB) to access individual photos or present a slideshow of all compatible photos on the device.

The display includes the following options:

- < or >: Move to previous/next photo.
- **Thumbnails**: Switch between full screen and minimised view.
- **New selection**: Choose another photo from the connected source device.
- **+**: Open pop-up menu; To change the source device or access the photo settings.

When viewing a photo/ slideshow, the pop-up menu also allows you to set zoom level and

display all photos in thumbnail form.

Photo settings - refer to (NAVI 80) "System settings" ⇨ 40.

Playing movies

NAVI 80 - Playing movies

To access the "Videos" menu from the Home page, press **MENU** then **Multimedia**, followed by **Videos** on the display screen.

Select the connected source device (e.g. SD card, USB) to access individual or all compatible videos on the device.

The display includes the following options:

- **◀◀** or **▶▶**: Move to previous/next video.
- **||**: Pause video.
- Scroll bar for time elapsed: Scroll through videos.
- **New selection**: Choose another photo from the connected source device.

- **Full screen:** Switch to full screen display.
- **←:** Return to previous screen.
- **+**: Open pop-up menu; To change the source device or access the video settings.

During video playback, the pop-up menu also allows you to return to the list of videos.

Video settings - refer to (NAVI 80)
"System settings" ⇨ 40.

Navigation

General information	74
Usage	78
Destination input	97
Guidance	106
Symbols overview	117

General information

⚠ Warning

The navigation system is an aid to your navigational abilities and does not replace them. Drive with due care and attention and adopt a safe, vigilant attitude.

If a navigation system instruction contradicts traffic regulations, the traffic regulations always apply.

The Navigation system will reliably guide you to your chosen destination without the need for physical road maps.

If the **Traffic info** service is available in your country or region, the current traffic situation is also considered in route calculations. The system receives traffic messages in the current reception area.

To receive the most up-to-date, real-time traffic information possible, subscribe to the Live services facility via the **TomTom™** website.

Note

Only available with
CD35 BT USB NAVI, NAVI 80.

Functioning of the Navigation system

The position and movement of the vehicle are detected by the Navigation system using sensors.

The distance travelled is determined by the vehicle's speedometer signal, and turning movements on bends are determined by a gyro sensor. The position is determined by GPS (Global Positioning System) satellites.

By comparing these sensor signals with the digital maps on the Navigation system, it is possible to accurately determine the position of the vehicle.

When using the vehicle for the first time, or after a ferry trip, etc., the system will self-calibrate. It is, therefore, normal if it does not provide an exact location until the vehicle has travelled for some distance.

After the entry of the destination address or point of interest (nearest petrol station, hotel, etc.) the route is calculated from the current location to the selected destination.

Route guidance is provided by voice output and the display screen.

Warning

Areas such as one-way streets and pedestrian zones are not marked on the navigation system map. In such areas, the system may issue a warning that must be accepted. Therefore, pay particular attention to one-way streets and other roads and entrances that must not be driven into.

Note

Depending on Infotainment system, radio reception may be interrupted during voice guidance and before each change of direction.

USB memory stick (NAVI 50)

A USB memory stick is required for the Navigation system, to contain, among other things, a digital map of the towns and roads in your country.

Note

Use a USB memory stick, formatted to FAT32 format, with a minimum 4 GB and maximum 32 GB of storage capacity.

After delivery of a new vehicle, there is a maximum of 90 days in which to update the digital map for free. After this time has elapsed, a fee is charged for map updates.

Note

To avoid possible technical issues, only use a compatible USB memory stick for operating and updating the Navigation system. Do not insert USB memory stick in any other device (e.g. digital camera, mobile phone, etc.), or in another vehicle.

Software installation

To update the digital maps and to benefit from exclusive downloadable services, an account must be created

on the opel.naviextras.com website and the free software must be installed.

Creating an account

Create your internet account via the opel.naviextras.com website. Select e.g., the "Register" option on the web page and enter the appropriate details.



Installing the software

Install the software on your computer by downloading from opel.naviextras.com.

Follow the on-screen instructions to install the software and launch the online application.

Registering the Navigation system

The Navigation system must be registered with your new internet account.

Insert an empty USB memory stick in the Navigation system's USB slot. Press  then select  **NAVI** /  **Nav**, followed by **Options** then **Map update**.

To ensure all content is saved in the Navigation system's memory, select **Options** then **Update**. Wait for the update to complete before ejecting the USB memory stick.

Then insert the USB memory stick in your computer's USB slot while connected to the Internet. When the online application is launched and the USB memory stick is recognised, the system (or software) name appears in the application window. The Navigation system is registered into your user profile.

After the initial set-up, the USB memory stick is automatically recognised by the Navigation system and by the online application.

Updating the USB memory stick and Navigation system

Updates are issued regularly, e.g. for map and safety camera revisions.

Note

In certain countries it is illegal to download and activate the camera warning option and this could lead to prosecution.

These updates are only available via the online application catalogue, which is accessed via the USB memory stick.

Using the online application, it is possible to:

- update the Navigation system (maps, safety cameras etc.)
- upgrade to premium POI content
- add or delete data
- customise the system

The online application menus guide you through these operations.

System update

To get the best from the Navigation system, update it as often as possible.

Insert the USB memory stick in the Navigation system's USB slot. Available updates on the USB memory stick are recognised by the Navigation system and the 'Update' screen is displayed automatically.



Select **Update** to begin installing the updates to the Navigation system.

Note

The Navigation system may restart automatically during the update process.

Note

Press ← to go back to the previous screen.

Alternatively, press  followed by  **NAVI** /  **Nav**, **Options** then **Map update**. Then select **Options** followed by **Update** to install updates to the Navigation system.

Wait for the update to complete before performing any other operation or ejecting the USB memory stick.

SD card (NAVI 80)

An SD card is required for the Navigation system and contains, among other things, a digital map of the towns and roads in your country.

Note

To avoid possible technical issues, only use a compatible SD card for operating and updating the Navigation system. Do not insert SD

card in any other device (e.g. digital camera, mobile phone, etc.), or in another vehicle.

SD card (CD35 BT USB NAVI)

An SD card is supplied with the Navigation system and contains, among other things, a digital map of the towns and roads in your country.

After delivery of a new vehicle, there is a maximum of 60 days in which to update the digital map for free. After this time has elapsed, a fee is charged for map updates.

Note

To avoid possible technical issues, only use a compatible SD card for operating and updating the Navigation system. Do not insert SD card in any other device (e.g. digital camera, mobile phone, etc.), or in another vehicle.

TomTom HOME™ software installation

To update the digital maps and to benefit from exclusive downloadable services, including real-time safety and traffic alerts, an account must be

created on the TomTom™ website and the free **TomTom HOME™** software must be installed.

Creating an account

Create your TomTom™ internet account via the TomTom™ website. Select e.g., the **Create account** option on the web page and enter the appropriate details.

Installing the software



Insert the SD card in your computer's card reader (or an external card reader) while connected to the Internet. The software installation is launched automatically.

Follow the on-screen instructions to install the free TomTom HOME™ software.

Your SD card is automatically recognised by the system after the initial set-up.

Updating the SD card and Navigation system

Updates are issued regularly, e.g. for map and safety camera revisions.

These updates are only available via the **TomTom HOME** software, which is accessed via the SD card.

Using the **TomTom HOME** software, it is possible to:

- update the Navigation system (maps, safety cameras etc.)
- subscribe to LIVE services
- save the system data onto your computer
- add or delete data
- customise the system
- share map corrections with the community (**Map Share™**)
- download the full TomTom™ Navigation system user manual

The TomTom HOME software menus guide you through these operations.

System update

To get the best from the Navigation system, update it as often as possible. **Map Share™** map updates, for example, can be shared with the entire community of system users.

Main functions of TomTom HOME application

Download new and extra maps

Select the **Add Maps** icon to access the menu where maps can be downloaded.

Downloading voices, points of interest, etc.

Select the Add Traffic, Voices, Safety Cameras, etc. icon to:

- download voices to customise the system
- download points of interest, etc.

Note

In certain countries it is illegal to download and activate the camera warning option and this could lead to prosecution.

Save the SD card and system data

System data can be saved on your computer and also restored, if necessary.

It is recommended that the system data is saved on a regular basis. Saving the data allows it to be recovered if, for example, the SD card is lost or damaged.

Download instructions

It is possible to access to the full TomTom™ Navigation system user manual for the system.

Customise the system

It is also possible to customise the system by installing new points of interest and synthesised voices and by changing the colour scheme.

Usage

USB memory stick

NAVI 50

Inserting the USB memory stick

Switch off the Navigation system and insert the USB memory stick in the USB slot on the Infotainment system fascia. The USB memory stick is fragile; treat it with care.

Removing the USB memory stick

Switch off the Navigation system and remove the USB memory stick from the USB slot on the Infotainment system fascia.

SD card

Switch off the Navigation system and insert the SD card in its slot. The SD card is fragile; do not bend it.

CD35 BT USB NAVI

Inserting the SD card

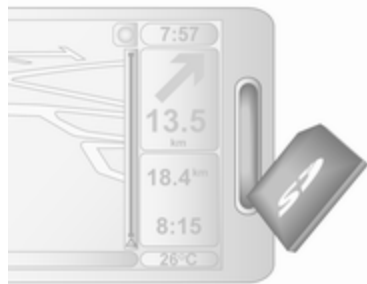

Ensure the SD card is inserted the correct way. The orientation may differ, depending on location of the SD card slot in the vehicle.

Removing the SD card

Select **Remove SD card** in the main menu, then confirm using the right soft button \rightarrow . A message is displayed when it is safe to remove the SD card. To remove the SD card from its slot, press on the card then release it. The card is released slightly to enable it to be withdrawn.

NAVI 80

Inserting the SD card

Switch off the Infotainment system and insert the SD card in its slot. The SD card is fragile; do not bend it.

Ensure the SD card is inserted the correct way. The orientation may differ, depending on location of the SD card slot in the vehicle.

Removing the SD card

To remove SD card from the Infotainment system, on the Home page press **MENU**, then **System** followed by **Remove SD card** on the display screen; The SD card can now be ejected safely.

To remove the SD card from its slot, press on the card then release it. The card is released slightly to enable it to be withdrawn.

Note

To avoid possible technical issues, only use a compatible SD card for operating and updating the Navigation system. Do not insert SD card in any other device (e.g. digital camera, mobile phone, etc.), or in another vehicle.

Remote control

CD35 BT USB NAVI

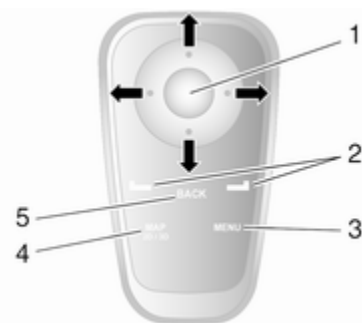

1. Central button: Confirm, access the quick menu
Press up, down, right, left: Move around menu or map
Press up/down: Adjust the map scale (zoom in/out)
Press right: Access traffic information
2. Soft buttons (\leftarrow and \rightarrow)
From menu: Select and confirm actions

From map: Left button (←) - repeats a voice instruction;
Right button (→) - displays route summary

3. **MENU**: Access the main menu

4. **MAP 2D/3D**

From menu: Displays map

From map: Switches map to 2D/
3D mode

5. **BACK**: Back to previous screen



The soft buttons (← and →) select or confirm actions which appear at the bottom of the screen.

The LED on the remote control flashes once when the remote control is connected to the Navigation system. To connect it more quickly, press one of the remote control buttons when the system starts, before the legal notices appear.

If the LED flashes and a message appears on the screen, the batteries require replacing.

Battery replacement



Press down latch on the back of the unit and lift out the keypad.

Insert new batteries (Type: AAA / LR03 / UM4 1.5V) ensuring they are installed correctly, then replace the battery cover.

Activating the Navigation system

Switching on

The Navigation system switches on automatically when the ignition is switched on. In other cases, press ⏻.

With the ignition off, the Navigation system can be used for approx. 20 minutes. Press ⏻ to switch on the Navigation system again. The system will automatically switch off approx. 20 minutes after the last user input.

Switching off

With the ignition off, the Navigation system switches off automatically when the driver's door is opened.

With the ignition on, press ⏻ to switch off the Navigation system.

Switching between Navigation system and Infotainment system menus

CD35 BT USB NAVI

With the Infotainment and Navigation systems on, press **NAVI** (on the steering column controls) to switch between the Navigation system and Infotainment system screens.

When the Infotainment controls are used to change, for example, the audio source, the Infotainment system screen pops-up temporarily over the Navigation system screen. The display switches back after a delay.

Note

The clock is displayed when switched to the Infotainment system screen.

NAVI 50

With the Navigation system active, press **NAV** or press and hold **NAV** on the display screen to return to the Infotainment system Home menu.

NAVI 80

With the Navigation system active, press **NAV** on the display screen (one or more times) to return to the Infotainment system Home page.

Information on the display

CD35 BT USB NAVI - Information on the display

Menu screen

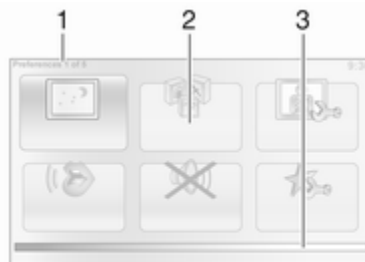

The menu screen contains the following:

1. Menu name
2. Sub-menu selection
3. Menu page scroll bar

To access the main menu, press **MENU**.

Menus may contain multiple screen pages. The scroll bar indicates the current position.

Quick menu

The **Quick menu** contains a preset selection of some commonly used menu items (e.g. hide map, cancel route, switch on/off voice guidance).

To access the Quick menu, press the central button on the remote control.

Map screen

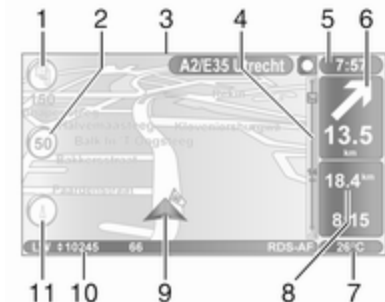

The map screen contains the following:



1. Warning of the next risk area within distance (fixed or mobile speed camera, school, etc.)
2. Speed limit. Illuminates red and flashes if speed limit is exceeded
3. Name of the next major road or road sign information, if applicable
4. Traffic sidebar: Display of incidents on the route, traffic info reception indicator
5. Current time
6. Direction and distance to next change of direction
7. Outside temperature (depending on vehicle)
8. Journey information, e.g. estimated arrival time, total remaining distance
9. Current location
10. Audio system information
11. Compass

To access the map screen at any time, press **MAP 2D/3D**.

Ensure any changes made are confirmed with the soft buttons (⏪ and ⏩) before switching to the map screen, otherwise the changes will be lost.

In the map screen, press **MAP 2D/3D** again to switch between 2D/3D map modes.

NAVI 50 (Type A) - Information on the display Menu screen

To access the Navigation menu screen, press  followed by  **NAVI** on the display screen.



The Navigation menu screen contains the following menus and submenus:

- **Destination**

Refer to (NAVI 50) "Destination input" ⇨ 97.

- **Address**
- **Points of Interest**
- **History**
- **Favourites**
- **Find on Map**
- **Coordinate**

- **Route**



Refer to (NAVI 50) "Route information" and "Edit Itinerary" in the "Guidance" section ⇨ 106.

- **Create Route/Edit Route**
- **Avoidances**
- **Overview**
- **Cancel Route**
- **Alternative Routes**
- **Itinerary**
- **Options**



Refer to (NAVI 50) "Setting up the navigation system" below.

- Warnings
- Route settings
- Map settings
- Voice settings
- Coordinate format
- GPS
- Map update

Map screen





To access the map screen without route guidance, press  followed by  on the display screen. Refer to (NAVI 50) "Browse map" in the "Guidance" section  106.

Press anywhere on the map. The cursor indicates the current selected position. To scroll within the map, drag the cursor in the required direction.

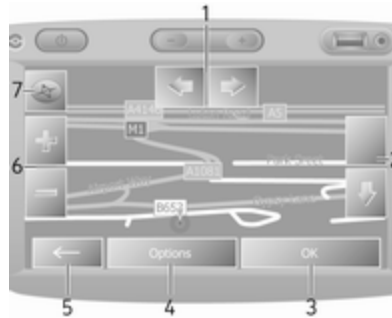
To access the map screen with route guidance, press  followed by  on the display screen and enter a destination. Refer to (NAVI 50) "Destination input"  97.

The map screen (with or without route guidance) contains the following controls and information:



1. : Rotate map left/right
2. : Viewpoint (low/high view)
3. **OK** (with countdown timer): Confirm actions
4. **Options** menu
5. : Return to previous screen
6. : Change scale (zoom in/out)
7. : Compass (press to switch between 2D/3D map modes)

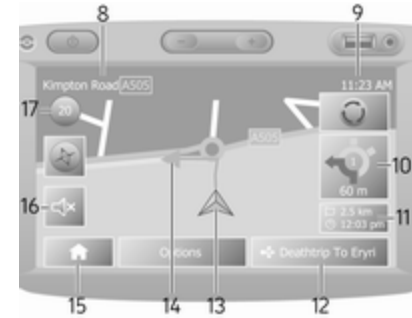

8. Name of the next major road or road sign information, if applicable
9. Current time
10. Direction and distance to next change of direction
11. Journey information, e.g. estimated arrival time, total remaining distance
12. Audio system information
13. : Current location
14. Route calculated and direction changes
15. Home menu

16. : Voice guidance on/off

17. Speed limit

Intersection view

During route guidance, before each change of direction a close-up view of the intersection is automatically displayed. The normal view is resumed after passing the intersection.

Motorway view

During route guidance, before each motorway junction a 3D view of the junction is automatically displayed. The normal view is resumed after passing the junction.

Note

For some motorway junctions, only a small turn arrow may appear on the map.

NAVI 50 (Type B) - Information on the display

Menu screen

To access the Navigation menu screen, press  followed by  Nav.

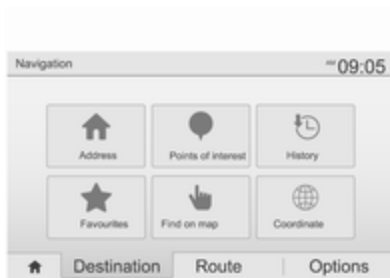

The Navigation menu screen contains the following menus and submenus:



- **Destination**

Refer to (NAVI 50) "Destination input" ⇨ 97.



- **Address**
- **Points of interest**
- **History**
- **Favourites**

- **Find on map**
- **Coordinate**
- **Route**
Refer to (NAVI 50) "Route information" and "Edit Itinerary" in the "Guidance" section ⇨ 106.
 - **Create Route/Edit Route**
 - **To avoid**
 - **Overview**
 - **Cancel Route**
 - **Alternative routes**
 - **Route**
- **Options**
Refer to (NAVI 50) "Setting up the navigation system" below.
 - **Warnings**
 - **Route settings**
 - **Map settings**
 - **Voice settings**
 - **Coordinate format**
 - **GPS**
 - **Map Update**
 - **Traffic**

Map screen

To access the map screen without route guidance, press  followed by  (if available). Refer to (NAVI 50) "Browse map" in the "Guidance" section ⇨ 106.





Press anywhere on the map. The cursor indicates the current position. To scroll within the map, drag the map in the required direction. To return the cursor to the current vehicle position at any time, press .

To access the map screen with route guidance, press  followed by  on the display screen and enter a destination. Refer to (NAVI 50) "Destination input" ⇨ 97.

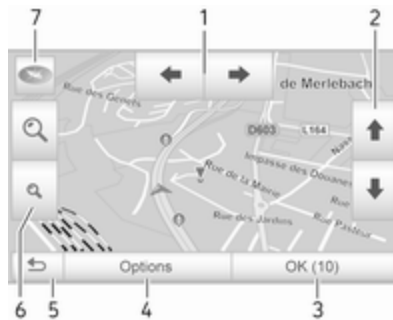
Press anywhere on the map. The cursor indicates the current position. To scroll within the map, drag the map in the required direction.

The map screen (with or without route guidance) contains the following controls and information:



1. : Rotate map left/right
2. : Viewpoint (low/high view)
3. **OK** (with countdown timer): Confirm actions
4. **Options** menu (for route and map settings)
5. : Return to previous screen
6. : Change scale (zoom in/out)
7. : Compass (press to switch between '2D', '3D' and '2D North' map modes)



8. Name of the next major road or road sign information, if applicable
9. Current time
10. Direction and distance to next change of direction
11. Journey information, e.g. estimated arrival time, total remaining distance
12. Audio system information (press to access audio source)
13. Route calculated and direction changes
14. : Current location
15. Home menu

16. : Traffic information (TMC - Traffic Message Channel)

17. Speed limit

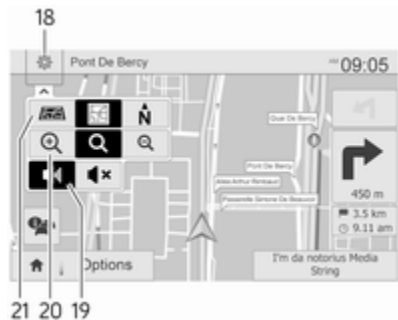

18. : Settings pop-up menu (see items below)

19. : Voice guidance on/off

20. : Change scale (zoom in/out)

21. : Switch between '2D', '3D' and '2D North' map modes

Intersection view

During route guidance, before each change of direction a close-up view of the intersection is automatically

displayed. The normal view is resumed after passing the intersection.

Motorway view

During route guidance, before each motorway junction a 3D view of the junction is automatically displayed. The normal view is resumed after passing the junction.

Note

For some motorway junctions, only a small turn arrow may appear on the map.

NAVI 80 - Information on the display Menu screen

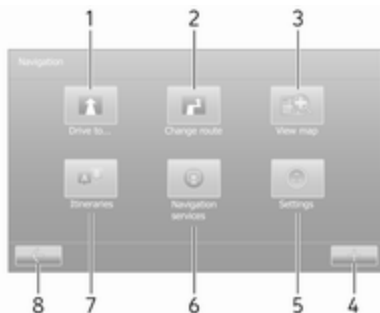

On the Home page, press **MENU** followed by **Navigation** on the display screen to access the Navigation menu.

The Navigation menu screen contains the following menus, submenus and controls:

1. DRIVE TO ...

Refer to (NAVI 80) "Destination input" ⇨ 97.

- Home
- Saved locations
- Address
- Recent destinations
- Local search/TomTom places
- Point of Interest
- Point on map
- Latitude Longitude

2. CHANGE ROUTE

Refer to (NAVI 80) "Edit Itinerary" in the "Guidance" section ⇨ 106.

- Calculate alternative
- Cancel route
- Travel via

- Avoid roadblock
- Avoid part of route
- Minimise delays

3. VIEW MAP

Refer to (NAVI 80) "Browse map" in the "Guidance" section ⇨ 106.

- Use this position to...
- Find
- Change the map details
- Add to saved locations

4. : Pop-up menu

5. SETTINGS

Refer to (NAVI 80) "Setting up the navigation system" below.

- Turn off voice guidance
- Route planning
- Show POI on map
- Manage POIs
- Voice
- EV settings
- Set home location
- Manage saved locations
- Switch map
- Change map colours

- Car symbol
- Advanced

6. NAVIGATION SERVICES

Refer to (NAVI 80) "LIVE services" below.

- Traffic
- Speed Cameras
- Local search/TomTom places
- My TomTom live
- Weather

7. ITINERARIES

Refer to (NAVI 80) "Edit Itinerary" in the "Guidance" section ⇨ 106.

8. : Return to previous screen

Map screen



To access the map screen without navigation, on the Home page press **MENU**, then **Navigation** followed by **View Map** on the display screen.

Press anywhere on the map. The cursor indicates the current selected position. To scroll within the map, drag the cursor in the required direction.

To access the map screen with navigation, on the Home page press **MENU** followed by **Navigation** on the display screen and enter a destination. Refer to (NAVI 80) "Destination input" ⇨ 97.

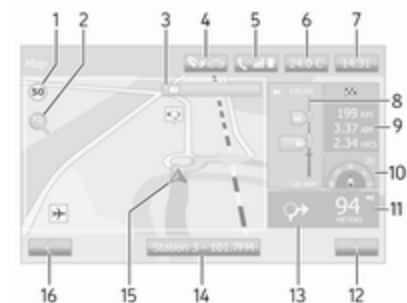
The map screen (with or without route guidance) contains the following controls and information:



1. Speed limit (illuminates red and flashes if speed limit is exceeded)
2. : Change scale (zoom in/out)
3. Name of the next major road or road sign information, if applicable
4.  Outside air quality

5. 📞 : Phone information
6. Outside temperature
7. Clock
8. Traffic information, e.g. route incidents, reception indicator, traffic map
9. Journey information, e.g. estimated arrival time, total remaining distance, journey status (green flag/red flag)
Route summary
10. Compass (press to switch between 2D/3D map modes)
11. Change volume of guidance instructions
12. ⚡ : Pop-up menu
13. Direction and distance to next change of direction
14. Audio system information
15. 📍 : Current location (cursor)
Route calculated and direction changes
16. ⬅️ : Return to previous screen

Lane images

During route guidance, before each major road change, a 3D view of the junction (with a turn arrow and road signs) is automatically displayed. The normal view is resumed after passing the junction.

To switch off the lane images view, refer to (NAVI 80) "Advanced Settings" in "Setting up the navigation system" below.

Automatic zoom



During route guidance, before each change of direction a close-up view of the junction is automatically displayed. The normal view is resumed after passing the junction.

To switch off the automatic zoom feature, refer to (NAVI 80) "Advanced Settings" in "Setting up the navigation system" below.

Operating keyboards in the display

NAVI 50 - Operating keyboards in the display

To move within and to enter characters in both the alphabetical and numerical keyboards, make the appropriate selection by touching the display screen.



- Select **Options** to change the keyboard type (e.g. Qwerty, ABC).
- Select **1^&** to switch to numbers and symbols.
- Select the drop down menu icon  to display a list of results for the current operation (e.g. destination input).
- Entries can be corrected during input with the  keyboard character.
- Press **⬅️** to stop using the keyboard and return to the previous screen.

Note

When making an entry, certain letters and numbers are unavailable for selection (greyed-out) based on the information stored in the Navigation system.

NAVI 80 - Operating keyboards in the display

To move within and to enter characters in both the alphabetical and numerical keyboards, make the appropriate selection by touching the display screen.

- Entries can be corrected during input with the  keyboard character.
- Press  to stop using the keyboard and return to the previous screen.

Guided tours**CD35 BT USB NAVI**

The system offers tutorials to enable quick familiarisation with the different functions.

Select **Guided tours** in the main menu, then the required tour:

- **Remote control operation**
- **Driving view**
- **Menu options**
- **Browse map**
- **Route planning**
- **Itinerary planning**
- **Traffic information**
- **Warnings and notifications**
- **Quick menu**
- **TomTom HOME**

Live services**CD35 BT USB NAVI - Live services**

Live services includes road safety alerts, up-to-date traffic information with HD Traffic™, local search with Google™ and a weather forecast.

These features are available for a free 3 month trial period, after which a subscription is required. Visit the TomTom website and refer to the **Services** section to subscribe to **LIVE services**.

Note

LIVE services are not available in some countries or regions.

To check the status of your subscription at any time, select **My Services** in the **LIVE services** menu. Some features will not be available for selection in the main menu until a subscription to live services has been set up. To access these features, select **LIVE services** from the Navigation system main menu.

Safety alerts

This service includes the location of mobile speed cameras in real-time, fixed speed cameras and accident blackspots.

The latest fixed camera updates can be downloaded via the TomTom HOME™ website.

This service can be activated or deactivated at any time via **Safety Alerts** in the **LIVE services** menu.

HD Traffic™

To only receive up-to-date, real-time traffic information and to plan the best route to your destination, select **HD Traffic** in the **LIVE services** menu.

Note

The **HD Traffic** service is named **Traffic** if a subscription has not been activated.

TomTom places / Google™ local search

This service allows you to use a keyword to quickly find any Point of Interest (POI) and set it as a destination.

Weather

The weather forecast service provides up to 5 days of weather reports for your current location and your chosen destination.

NAVI 80 - Live services

In addition to the free navigation services (e.g. traffic information, fixed speed cameras), extra features can be added by subscribing to paid LIVE services.

LIVE services include up-to-date traffic information with "HD Traffic™", updates and locations of fixed and mobile speed cameras, local search, weather forecast and the "My TomTom LIVE" subscription status.

Note

LIVE services are not available in some countries or regions.

The following menus are displayed:

- **Traffic/HD Traffic**

Select to receive up-to-date, real-time traffic information.

Note

The **HD Traffic** service is named **Traffic** if a subscription has not been activated.

- **Speed cameras**

Displays alerts and location of mobile speed cameras in real-time, fixed speed cameras and accident blackspots.

Note

Speed camera information is updated online by the entire community of system users.

Switch function off via the "Speed Cameras" menu in "LIVE services", if required.

Note

In certain countries it is illegal to download and activate the camera

warning option and this could lead to prosecution.

- **Local search/TomTom places**

This service allows you to use a keyword to quickly find any Point of Interest (POI) and set it as a destination.

- **My TomTom LIVE**

Displays expiry date of subscribed services. Renew subscriptions via the Store.

Note

A valid email address must be entered to use this service.

Note

Invoices are sent to the entered email address, with (if necessary) the install instructions and user information for the applications, services or other downloaded content.

- **Weather**

The weather forecast service provides up to 5 days of weather reports for your current location and your chosen destination.

Image viewer

CD35 BT USB NAVI - Image viewer

The system can be used to view images. Select **Image viewer** in the main menu; the image gallery opens and an image can be selected.

To scroll through the images in slideshow mode, select **Slideshow** using the right soft button \rightarrow and set the seconds-per-slide when prompted, using the directional buttons.

To set the slideshow to manual mode, select **Manual** by moving to the far right of the seconds-per-slide display, then use the directional buttons to scroll through the images manually. Start the slideshow by pressing the right soft button \rightarrow .

Images can be added or deleted when updating the Navigation system.

Compatible image formats are:

- JPG: Greyscale and RGB
- BMP: 1-bit, 2 colours; 4-bit, 16 colours; 8-bit, 256 colours and 24-bit, 16.7 million colours

Setting up the navigation system

CD35 BT USB NAVI - Setting up the navigation system

Navigation volume

To change the volume during a voice instruction, turn \odot or press $+$ or $-$.

Alternatively, press \rightarrow or \leftarrow on the steering column controls to change the volume.

To repeat a voice instruction, press the left soft button \leftarrow .

System preferences

The system can be adjusted to suit personal requirements. Select **Change preferences** in the main menu to view the adjustable preferences.

Certain menu items can also be found more quickly in the Quick menu. Press the central button on the remote control to open the **Quick menu**.

Change Home location

To change the location of your designated home.

Manage favourites

To delete stored favourite destinations. Select the desired entry followed by **Done** using the soft button to delete the entry.

Switch map

Used if installing several maps on the SD card. To change map, select **Switch map**, then select the map required.

Voice preferences

To select a voice used to give voice instructions and to select either human or synthesised voices.

The human voice instructions provide simplified guidance only, while the synthesised voice instructions provide road directions plus additional information (e.g. traffic signs and traffic information etc.).

Disable voice

To deactivate the voice instructions and use only the map screen for guidance.

Turn off sound

To deactivate all sound, including voice instructions and alerts etc.. To turn the sound back on, select **Turn on sound**.

Safety preferences

To activate sound warnings during driving (e.g. when exceeding a set speed or when approaching schools etc.). This option can also be used to simplify the menus.

Planning preferences

Five types of planning preferences are selectable. The recommended preference is **Fastest route**.

After having selected the planning criteria, the system permits the activation of the IQ Routes™ function. If activated, this function plans the best route taking the actual road speeds into account.

Toll road preferences: After having entered a destination, the system asks if you wish to change this request. Select one of the 3 types of planning preferences, then finish using the right soft button ↵.

Road types: Select preferences in terms of particular sections of the journey, such as unmade roads and ferry transfers.

Show lane images

When approaching a major road change, the system may switch to a close-up view of the junction with a turn arrow and road signs. This feature can be deactivated, if preferred.

Automatic zooming

During guidance, the display gradually zooms in before each change of direction. If preferred, this mode can be deactivated.

Show POI on map

To select the points of interest (POIs) which appear on the map.

Manage POIs

To add, modify or delete points of interest (POIs) or POI categories.

Set units

Units of distance: Select **Miles** or **Kilometres**, then select **Done** using the soft button.

Clock display: Select from the 3 clock display mode options, then select **Done** using the soft button to move to the next step.

Coordinates: Select from the 3 latitude and longitude display options, then select **Done** using the soft button to move to the next step.

Show/hide tips

When using the Navigation system, the system will display tips to help get the best use of the functions. These can be deactivated by selecting **Hide tips**. To reactivate, select **Show tips**.

Change car symbol

Changes the style of the car symbol.

2D map settings

To change the default map settings between 2D and 3D.

Compass preferences

Changes the compass display on the map screen.

Status bar preferences

Add to the list of options that appear on the navigation map status bar.

Name preferences

To display street and house numbers on the map.

Use day/night colours

In the default automatic mode, the system will automatically switch between day and night modes.

If manual mode is preferred, automatic mode can be deactivated by selecting **Use day colours** or **Use night colours**.

Automatic switching can be reactivated using the **Brightness preferences** menu.

Change map colours

New colours can also be downloaded. To select a downloaded colour, select an additional colour scheme, then the colour required.

Brightness preferences

Adjust the screen brightness to suit the external lighting conditions.

Set clock

When the clocks change in summer or winter, or when travelling abroad, the time on the system will need adjusting. Select **Set clock**; the system offers three display modes.

Select the desired mode, then **Done** using the soft button. Set the clock, then select **Done**.

Clock synchronisation: The synchronisation option allows the time to be set directly using GPS information. Select the **Sync** option with the left soft button \leftarrow .

Start-up preferences

Used to change the system start-up settings and also the start-up page by customising it with a chosen photo.

Show fewer menu options

Allows simplification of the menu to facilitate better use. To reactivate all options, select this icon again.

Change language

To change language, select **Language**; the required language can then be selected from the list.

Reset factory settings



To reset all system parameters and delete all personal data.

Select **Reset factory settings** in the main menu, then follow the on-screen instructions using the soft buttons.

Partial reset: allows the deletion of all personal data (favourites, recent destinations, etc.).

After resetting, the system will restart in English.

NAVI 50 - Setting up the navigation system

Press  followed by  **NAVI** /  **Nav** then **Options**. This menu screen allows you to check and update the following map and navigation settings:

- **Warnings**
- **Route settings**
- **Map settings**
- **Voice settings**
- **Coordinate format**
- **GPS**
- **Map update**
- **Traffic** (depending on version)

Warnings

Select **Warnings** to access the following settings (switch off if not required):

- **Warn when speeding** (On/Off)
- **Speed limit always visible** (On/Off)
- **Alert point warnings** (On/Off)
- **Pre-alert distance** (0 m/200 m/500 m)

Available depending on version.

Warn when speeding: The digital map contains speed limits for certain roads. Audio and/or visual warnings are given when the vehicle exceeds the speed limit.

Speed limit always visible: The speed limit for certain roads is always visible on the screen.

Alert point warnings: When the vehicle passes an alert point (permanent or temporary) - i.e. when entering a potentially hazardous area requiring extra caution - audio and visual warnings are given.

Pre-alert distance: Select a distance from which notifications of alert point warnings should be given.

Note

Warnings may not be available for some roads and regions.

Route settings

Select **Route settings** to update the following settings for route calculation:

- **Route planning method** (Fast/Short/ECO)
- **Motorways** (On/Off)
- **Period charge** (On/Off)
- **Per-use toll** (On/Off)
- **Ferries** (On/Off)
- **Carpool/HOV** (On/Off)
- **Unpaved roads** (On/Off)

If necessary, press **Options** then **Reset to defaults** to set each of these options back to the factory default settings.

Alternatively, when the map is displayed (no route guidance is active), the **Route settings** menu can be accessed by pressing **Options**.

Refer to (NAVI 50) "Information on the display", "Map screen" above for further information.

Route planning method: Select **Fast** to set the fastest route to the destination entered. This method assumes the vehicle travels at or near the speed limit on all roads.

Select **Short** to set the shortest route and minimise the total distance to travel to the destination entered.

Select **Eco** to set a compromise between the fastest and the shortest route planning methods. The route provided may be shorter than the fastest method, but not significantly slower.

Motorways: To include or exclude motorways from the route plan.

Turn off, e.g. when towing a vehicle, or when motorway driving is not permitted.

Note

Follow the regulations of the country in which you are driving.

Period charge: To include or exclude roads which require a special license to be purchased for certain periods.

Per-use toll: To include or exclude roads for which a toll must be paid to use the road once only.

Ferries: To include or exclude the use of ferries, ships and trains.

Carpool/HOV: To include or exclude carpool lanes and high-occupancy vehicle (HOV) lanes.

Unpaved roads: To include or exclude the use of unpaved roads, e.g. dirt, gravel roads.

Map settings

Select **Map settings** to access the following:

- **View mode** (3D/2D/2D North)
2D North is available depending on version.
- **Viewpoint** (Low/Normal/High)
- **Motorway view** (On/Off)
- **POI markers**

Alternatively, when the map is displayed (no route guidance is active), the **Map settings** menu can be accessed by pressing **Options**.

Refer to (NAVI 50) "Information on the display", "Map screen" above for further information.

View mode: Select **View mode** to change the default map mode between a 2D top-down view, a 3D perspective view and a 2D view with North always facing upwards.

Alternatively, press the Compass on the map to switch between map view modes.

Viewpoint: Select **Viewpoint** to raise or lower the map view.

Alternatively, when the map is displayed (no route guidance is active), press \hat{u}/\hat{d} to raise or lower the map view. They are greyed-out when the maximum position is reached.

Motorway view: Select **Motorway view** to switch on/off the motorway junction view for route guidance.

Refer to (NAVI 50) "Information on the display", "Map screen" above for further information.

POI markers: Select **▶** alongside **POI markers** to display a list of Points of Interest (POI) types.

Use this screen to switch on/off (show or hide on map) certain POI type markers on the map, e.g. accommodation, airport, café or bar.

Select a POI type to open a list of its subcategories and switch on/off (show or hide) individual subcategories.

Note

POIs are only visible on the map depending on the zoom level.

Voice settings

Select **Voice Settings** to change voice guidance language.

Scroll the list of languages by pressing $\blacktriangle/\blacktriangledown$ then select a language and press **OK** to confirm selection.

Coordinate format

Select **Coordinate format** to change the format of co-ordinate entries to one of the following options:

- DD.DDDDD
- DD MM.MMM
- DD MM SS.S

GPS

Select **GPS** to view the GPS information, e.g. available satellites, their location and signal strength.

Map update

Select **Map update** to display the following digital map content and latest update information:

- **Alert Points**
- **Junction View**
- **Maps**
- **Places**
- **Preprocessed Road Network**

Specific content or all map content can be updated. Select one of the options first or press **Options** then **Update**. Wait for the update to complete.

Refer to "USB memory stick" (NAVI 50), "Updating the USB memory stick and Navigation system" in the "General information" section ⇨ 74.

Traffic

Select **Traffic** to change the following traffic information settings:

- **Traffic info** (On/Off)
- **Detour**
- **Event types**

Traffic info: Warnings are given for incidents that occur along the route.

Detour: Save time by using an alternative route when a traffic jam or an incident occurs along the current route. Select 'On'/'Off' alongside "Confirm offered route?" as required.

If necessary, update the time value for the option "Offer detour if the calculated route saves more than:" (e.g. 5 minutes) by pressing ◀/▶.

Event types: Select the type of events to be displayed during route guidance, e.g. all events, traffic flow events, closures and blockages, accidents.

NAVI 80 - Setting up the navigation system

To access the Navigation settings menu from the Home page, press **MENU** then **Navigation**, followed by **Settings** on the display screen. The following settings submenus are displayed:

- **Turn off voice guidance:**
Switch on/off voice guidance during navigation.

- **Route planning:**

Select a planning preference type; "Fastest route" is recommended. The eco-route is designed to save the most fuel.

Then switch on/off "iQ routes™" as required. iQ routes™ enables routes to be calculated according to average traffic levels during a particular day and time, and also the best route according to actual traffic speeds.

- **Show POI on map:**

Show or hide categories of POI markers on the map.

- **Manage POIs:**

Add, change or delete POIs or POI categories.

- **Voice:**

Select synthesised voice or a male or female human voice (for the voice instructions) from the available list.

Human voices provide more simplified voice guidance instructions and are not available

when using the Voice recognition function ⇨ 118.

- **EV settings:**
Not used.
- **Set home location:**
Change the home or most used destination address.
- **Manage saved locations:**
Delete or rename saved destination addresses.
To rename, select an address from the displayed list, press **Rename** then enter a new name. Press **Done** to confirm. To delete a selected address, press **Delete** and confirm when prompted.
- **Switch map:**
If more than one map is installed on the SD card, use this option to switch between the saved maps. Select "Change map" then choose the desired map from the options available.
- **Change map colours:**
Change day and night colours used on Navigation map

For downloaded new colours; choose a new colour, select additional colour scheme, then choose the desired colour from the options available.

- **Car symbol:**
Change the vehicle icon used on the 3D navigation map.
- **Advanced:**
Select from the following advanced options:
 - **Map information:**
Show/hide information displayed on the map, e.g. address number before street name, street names/ current street name, name of street after current street.
 - **Map behaviour:**
Change how the map operates with the following options:
Show lane images (e.g. at motorway junctions), rotate map with vehicle direction (2D mode only), switch to 3D mode automatically during

guidance, zoom automatically (2D mode, 3D mode).

- **Traffic source:**
Choose a traffic information source from the available list.

Destination input

CD35 BT USB NAVI - Destination input

Select a destination

From the main menu, select **Navigate to...**, then choose from the following options:

Home

Guides you to your home.

To store the address of your home location, see **Add and save a favourite**.

Favourite

A stored list of frequently visited destinations.

- Select **Favourite** and confirm.
- Select the required destination from the list and confirm.

To store a destination in the favourites list, see **Add and save a favourite**.

Note

The **Favourite** icon will be greyed out if no destinations have been saved as a Favourite.

Address

Enter either all or part of the address (i.e. city and street or city centre, area code etc.).

Note

Only addresses known to the system through the digital map are accepted.

- When using for the first time, set the destination country.
- Enter the name of the desired city. The system may suggest several cities (the first line is always highlighted in yellow).
- Select the desired city from the list of suggestions and select **Done** using the soft button.
- Proceed in the same way for **Street:** and **House number:**.



If the desired city does not appear in the brief list of suggestions, a complete list can also be accessed via the drop down arrow (in the top right corner of the screen).

The system stores previously entered cities in its memory. They can then be directly selected from the full list via the drop down arrow.

Recent destination

Select a destination from the list of addresses last used, which are automatically stored.

Point of Interest (POI)

A point of interest (POI) is a service, establishment or tourist area close to a location. POIs are classed in different categories (e.g. restaurants, museums, car parks, etc.).

Select **Point of Interest** and confirm, then search for a POI from the following options:

Search by POI name

Enter the name of the POI and the system will automatically search for the point of interest.

Search by POI category

Select the desired category type (e.g. museum), then choose the area required from the following options:

- **POI near you**
- **POI in city**
- **POI near Home**

Select **Done** to start the search.

TomTom places

Destinations and routes can be selected with the aid of the most up-to-date information.

Note

This feature is only available by subscribing to paid LIVE services.

Point on map

A destination from the map can be defined. Position the cursor on this destination and confirm. The system will calculate the route.

Latitude Longitude

Defines a destination using its latitude and longitude values.

Confirm the destination

Once the destination information has been entered, the system calculates the route. At the end of the calculation, the system displays the navigation summary and suggests two options:

- **Details:** Displays details of the journey in various forms. Refer to (CD35 BT USB NAVI) "Route information" in the "Guidance" section.
- **Done:** Guidance starts.

If not confirmed, this page will close after a few seconds and guidance starts automatically.

The IQ routes™ function can optimise the journey time using statistical data. To activate or deactivate this function, see **Route planning** in the **Usage** section.

Add and save a favourite

Select **Add Favourite** from the main menu.

The location for your Favourite can be selected from the following options:

Home

Save your home address as a favourite.

Favourite

Not used.

Address

When entering an address, choose from the following options:

- city centre
- street and house number
- area code
- crossing or junction

Recent destination

Select a favourite location from the list of those recently entered as a destination.

Point of Interest

When adding a point of interest (POI) to your Favourites, choose from the following options:

- **POI near you:** Search from a list of POIs near your current position.
- **POI in city:** Choose a POI in a particular town or city. The town/city must be specified.
- **POI near Home:** Search from a list of POIs near your home location.

When navigating to a destination, a selection can also be made from a list of POIs:

- **POI along route**
- **POI near destination**

My location

When stopped somewhere interesting, it can be saved as a Favourite. The system will always suggest a name, usually the address, but a name can be chosen. To enter the name, just start typing.

Point on map

Select the location of the Favourite using the cursor, then select **Done** using the soft button.

Latitude Longitude

Creates a Favourite by entering latitude and longitude values.

Delete or rename a favourite

Select **Change preferences**, then select **Manage favourites**: select the Favourite then **Delete item** or **Rename item** using the soft button.

Prepare route in advance

Journeys can be planned in advance, e.g. to find out how long a journey is expected to take, or to check the route.

Select **Prepare route** from the main menu. Choose a starting point in the same way as selecting the destination, then select a destination. Choose the type of route and confirm. The system plans the route and allows details to be viewed.

NAVI 50 - Destination input**Select a destination**

Press  followed by **NAVI** / **Nav** then **Destination**.

The following menu options are available for entering a destination:

- **Address**
Enter an address using the keyboard.
- **Points of Interest**
Select Points of Interest (POI), e.g. petrol station, restaurant, parking.
- **History**
Select from a list of previous destinations.
- **Favourites**
Select from a saved list of favourite destinations.
- **Find on map**
Select a destination by using the digital map.
- **Coordinate**
Enter the co-ordinates of the destination.

After a destination has been entered, wait for the 10 second countdown to expire or press **OK** to begin route guidance immediately.

Enter an address

Select **Address** and enter part or all of an address, e.g.:

- **Country**
- **Town**
- **Street**
- **Number**
- **Intersecting street**

Note

Full addresses can only be entered if they are recognised by the Navigation system.

When entering an address for the first time, press **Country**, then use the keyboard to enter the name of the country required. Alternatively, use the drop down menu icon  and select from a list of suggested countries.

Note

When entering an address, certain letters and numbers are unavailable for selection (greyed-out) based on the addresses recognised by the Navigation system.

Proceed in the same way to enter details for **Town**, **Street**, **Number** and **Intersecting street**.

The address is automatically stored in the memory, available for future selection.

For keyboard operation, refer to (NAVI 50) "Operating keyboards in the display" in the "Usage" section ⇨ 78.

Note

Number and **Intersecting Street** are only available after a **Street** has been entered.

When entering a **Street**, it is not necessary to specify the type of road (street, avenue, boulevard etc.).

Select Points of Interest (POI)

POIs can be selected as a destination using the following search options:

- Preset POI list
- POI categories
- Quick search for POIs via the map

Preset POI list

Select **Points of Interest** to choose from the frequently-used preset categories list (e.g. petrol station, parking, restaurant).

POI categories

Select **Points of Interest** followed by **Custom Search** to select from the list of categories and subcategories.

The search for POIs differs depending on the current situation:

- If route guidance is active, **Petrol station** and **Restaurant** POIs are searched for along the route, and **Parking** POIs are searched for around the destination.

- If there is no active route guidance, POIs are searched for around the current position.
- If the current position is not available (i.e. no GPS signal), POIs are searched for around the last known position.

The following options are available:

- **In a Town/Suburb**
To search for a POI within a selected town/suburb (the resulting list is ordered by distance from the town centre).
- **Along Route**
To search for a POI along the current route (the resulting list is ordered by length of the required detour).
- **Around My Position**
To search for a POI around the current position (the resulting list is ordered by distance from this position).
- **Around Destination/Vicinity of the destination**
To search for a POI around the destination of the current route

(the resulting list is ordered by distance from the destination).

When a list of POIs is displayed, they can be sorted or displayed on the map. Press **Options** to display the following:

- **Sort by name**
- **Sort by distance**
- **Sort by detour** (if route guidance is active)
- **Show all on map**

Quick search for POIs

Press anywhere on the map. The cursor indicates the current selected position. To scroll within the map, drag the cursor in the required direction.

Press **Options** followed by **Points of Interest Around Cursor** to show nearby POI names and their distance from the selected position on the map.

Alternatively, press **Find** and use the keyboard to search for a destination by name.

Select from previous destinations list

Select **History** to access a list of previously entered destinations.

To sort the list, press **Options** to display the following:

- **Sort by name**
- **Sort by distance**
- **Delete all**

Alternatively, press **Find** and use the keyboard to search for a destination by name.

Select from Favourites list

Select **Favourites** to access a list of saved favourite destinations.

When the list of favourites is displayed, they can be sorted or displayed on the map. Press **Options** to display the following:

- **Sort by name**
- **Sort by distance**
- **Show all on map**
- **Delete all**

Alternatively, press **Find** and use the keyboard to search for a favourite by name.

Select a destination by using the map

Select **Find on Map** to begin a search for a destination by scrolling the map.

Press anywhere on the map. The cursor indicates the current selected position. To scroll within the map, drag the cursor in the required direction.

Press **OK** to select the position as a destination.

Enter the co-ordinates of the destination

Select **Coordinate** to begin a search for a destination by entering its co-ordinates.

To change the format of the co-ordinates, press **Options** and select from the following:

- **Latitude/Longitude**

Values can be entered in any of the following formats:

- Decimal degrees
- Degrees and decimal minutes
- Degrees, minutes and decimal seconds
- **UTM** (Universal Transverse Mercator)

Confirm the destination

When a destination has been selected, the route appears on the map. Press **OK** and set as a **New route**.

If route guidance is active, the destination can be set as a **Waypoint** along the route.

Add and save a favourite

When a destination has been selected, press **Options** to display the following:

- **Add to Favourites:** Save the destination in the favourites list.
- **Current traffic:** Provides information on traffic incidents (depending on version).

Refer to (NAVI 50) "Traffic information" in the "Guidance" section ⇨ 106.

- **Info/News:** Displays information (e.g. address) for the selected POI.

Shows the location (address) of the position selected, provides the GPS coordinates (latitude/longitude) and also, if applicable, displays the phone number of a selected POI.

- **Back to car:** Return to current vehicle location.

Before saving a favourite, the name of the favourite can be changed by using the keyboard.

For keyboard operation, refer to (NAVI 50) "Operating keyboards in the display" in the "Usage" section ⇨ 78.

Delete a favourite

When a favourite has been selected, press **Options** before starting route guidance followed by **Delete Favourite** and confirm deletion.

To delete all favourite destinations, select the menu **Destination** then **Favourites** followed by **Options** then **Delete all** and confirm deletion.

NAVI 80 - Destination input

Select a destination

From the Home page, press **MENU** then **Navigation** followed by **Drive to...** on the display screen.

Select a destination from the following options on the display:

- **Home**
- **Saved locations**
- **Address**
- **Recent destinations**
- **Local search/TomTom places**
- **Charging station** (not used)
- **Point of Interest**
- **Point on Map**
- **Latitude Longitude**

Home

Guides you to your home address.

To store the address of your home location, from the Home page, press **MENU** then **Navigation**, followed by **Settings** on the display screen.

Select **Set home location** and enter an address.

Refer to (NAVI 80) "Setting up the navigation system" in the "Usage" section ⇨ 78.

Saved locations

Select from a list of previously saved destinations.

To delete or rename saved destinations, from the Home page, press **MENU** then **Navigation**, followed by **Settings** on the display screen.

Then select **Manage saved locations** and update the selected destination as required.

Refer to (NAVI 80) "Setting up the navigation system" in the "Usage" section ⇨ 78.

Address

Enter part or all of an address using the keyboard, e.g.:

- **Country**
- **Postcode**
- **Town/City**
- **Street**
- **House number**

Note

Full addresses can only be entered if they are recognised by the Navigation system.

When entering an address for the first time, the country of the destination will be requested. Use the keyboard to enter the name of the country required.

Suggestions may be shown on the display during input. Press to select a destination shown in the display, or press **List** to access the full list for the current part of the address.

Note

When entering an address, certain letters and numbers are unavailable for selection (greyed-out) based on the addresses recognised by the Navigation system.

Proceed in the same way to enter a **Postcode** or enter details for **Town/City, Street** and **Number**.

The address is automatically stored in the memory, available for future selection.

For keyboard operation, refer to (NAVI 80) "Operating keyboards in the display" in the "Usage" section ⇨ 78.

Recent destinations

Select from a list of previous destinations that have been automatically stored.

Local search/TomTom places

Select a nearby Point of Interest (POI) by entering key words using the keyboard.

Note

This feature is only available by subscribing to paid LIVE services.

For further information, refer to (NAVI 80) "LIVE services" in the "Usage" section ⇨ 78.

Point of Interest

POIs can be selected as a destination using the following search options:

- POI categories:

Select a POI category type (e.g. petrol station, restaurant, parking), then select a search area (e.g. **POI nearby**, **POI in town**, **POI at home**).

Enter a town/city name and press **Done** to confirm selection.

- POI names:

Enter name of a POI and select to begin a search.

Point on Map

Select a destination by using the digital map.

To scroll within the map, drag the cursor in the required direction, then confirm the position as a destination.

Latitude Longitude

Enter the co-ordinates of the destination.

Confirm the destination

When a destination has been selected, the route appears on the map and a route summary is provided in the **ℹ** tab.

Press the LIVE tab to view real-time traffic information. For further information, refer to (NAVI 80) "LIVE services" in the "Usage" section ⇨ 78.

Press **Done** to confirm the route.

Add and save a favourite**Add to saved locations**

From the Home page, press **MENU** then **Navigation** followed by **Drive to...** on the display screen.

Select **Recent destinations** and choose a destination from the displayed list.

Press **+** (to open a pop-up menu) then **Add to saved locations**, give a name to the destination using the keyboard, then press **Next**.

A message is displayed asking if the saved address should be set as the Home address. Select **Yes** or **No**. A message is displayed confirming that the address has been saved.

Add Favourite

On the Home page, press **★** to open the favourites menu and select **Navigation**.

To set a saved destination as a favourite, press **+** (to open a pop-up menu), then **Add Favourite**.

Choose from the displayed list to add a saved destination to the favourites.

For further information, refer to (NAVI 80) "Favourites" in the "Introduction" section ⇨ 24.

Delete a favourite

On the Home page, press **★** to open the favourites menu and select **Navigation**.

Press **+** and select **Remove all Favourites** or select a favourite from the displayed list then press **Remove a Favourite**. A confirmation message is displayed. Press **Delete** to confirm.

For further information, refer to (NAVI 80) "Favourites" in the "Introduction" section ↗ 24.

Guidance

Route information

CD35 BT USB NAVI - Route information

To view the route before guidance begins, select **View route** after a destination has been entered.

Select the details of the route from the following options:

Browse as text

Shows the route plan. Several details of the route will appear:

- direction change arrows
- road types
- road names
- distance before a junction

Browse as images

Shows changes in direction as images.

Browse map of route

Shows the map of the route.

Show route demo

Shows a demonstration of the route. The speed of the demonstration can be selected.



Show route summary

Shows details of the journey time, the distance and the type of route. To access this page directly from the navigation map, press the right soft button.

Show traffic on route

Shows an overview of traffic incidents affecting the journey.

NAVI 50 - Route information

To view the route before guidance begins, press  followed by  **NAVI** /  **Nav** then **Route** after a destination has been entered.

For the various methods of entering a destination, refer to (NAVI 50) "Destination input" ↗ 97.

The following options are available:

- **Edit Route**
Refer to (NAVI 50) "Edit Itinerary" below.
- **Avoidances/To avoid**
Refer to (NAVI 50) "Edit Itinerary" below.
- **Overview**
See below.
- **Cancel Route**
Refer to (NAVI 50) "Deactivating guidance" below.
- **Alternative Routes**
Refer to (NAVI 50) "Edit Itinerary" below.
- **Itinerary/Route**
Refer to (NAVI 50) "Edit Itinerary" below.

Overview

When the **Route** screen is displayed, press **Overview** to get a detailed plan for the current route and a bird's eye view of the route on the map.

This menu option contains the following information:

- name and/or address of the destination
- total time of the route
- total distance of the route
- special points and sections of the route (e.g. toll roads, motorways, etc.)
- alternative routes (e.g. Short, Fast, Economical)

When the **Overview** screen is displayed, press **Options** to access the following submenus:

- **Alternative routes**
Refer to (NAVI 50) "Edit Itinerary" below.
- **Itinerary**
Refer to (NAVI 50) "Edit Itinerary" below.
- **Route settings**
Refer to (NAVI 50) "Setting up the Navigation system" ⇨ 78.
- **Simulate navigation**
See below.

Note

These options can also be accessed during route guidance by pressing on the 'Journey information' (e.g. estimated arrival time, total remaining distance) area of the display screen.

Refer to (NAVI 50) "Information on the display" in the "Usage" section ⇨ 78.

Simulate navigation

This function enables you to see a rapid view of the suggested route.

The following options are available:

- ▶/|| : Start or pause the route simulation
- ⏪ : Move to previous manoeuvre
- ⏩ : Move to next manoeuvre
- 1x / 4x / 8x : Increase the speed of the route simulation
- ←/→ : Return to previous screen

NAVI 80 - Route information

To view the route before guidance begins, press **+** (to open a pop-up menu), then select **Route details** after a destination has been entered.

The following options are available:

- **Display instructions:**

Displays the route plan.

The following details are shown:

- direction change arrows
- road types
- road names
- distance before a fork in the road (km/miles)

- **Display route map:**

View a map of the route.

- **Display route demo:**

View a demonstration of the route.

- **Route summary:**

Return to the previous screen.

The details of the journey time, distance and the type of journey are displayed. Refer to

(NAVI 80) "IQ routes™" in the "Destination input" section ⇨ 97.

- **Display destination:**

View changes in direction as images.

- **Display traffic on route:**

Displays an overview of all traffic incidents affecting the current journey, with a detailed incident by incident view.

With a subscription to LIVE services, the "Live" tab provides a more detailed overview of the journey (e.g. traffic delays, fixed and mobile speed cameras).

For further information, refer to (NAVI 80) "LIVE services" in the "Usage" section ⇨ 78.

Edit itinerary

CD35 BT USB NAVI - Edit Itinerary

To modify the route, select **Find alternative** from the main menu. The following options are available:

Calculate alternative

Calculates an alternative to the route already planned. The system will look for another route from your current location to the destination.

Avoid roadblock

Select this if there is a roadblock or a line of traffic ahead which was not indicated by the Traffic info service. How much of the route to be avoided can be chosen: Avoid 100m, 500m, 2000m or 5000m.

The system will recalculate the route avoiding the section of the route for the selected distance.

Travel via...

Select this to change the route so that it passes a particular location, e.g. to pick someone up. The location is chosen in the same way the destination is chosen, so all the same options can be selected: **Address**, **Favourite**, **Point of Interest** and **Point on map**.

The system will calculate a new route to the destination that passes the chosen location.

Recalculate original

Returns to the original route.

Avoid part of route

Avoids a specific part of the route, such as a road or a junction. Choose the road to be avoided from the list of roads on the route.

Minimise traffic delays

Select this menu to plan the route based on the latest traffic information.

NAVI 50 - Edit Itinerary

This function makes it possible to view and change the route plan to the destination entered.

To access at any time, press  followed by **NAVI** / **Nav** then **Route**. Select **Itinerary/Route**.

The following information will appear:

- direction change arrows
- road number
- distance before a direction change

Press **Options** to change and sort the details of the route.

The following options are available:

- **Summary**

Shows each waypoint and the destination, including the waypoint distance, time left to next waypoint and arrival time.

- **Normal**

Shows each manoeuvre, with street or place names, distance, and route section numbers.

This option also shows signpost information, access and manoeuvre restrictions, warnings and system preference information.

- **Road list**

Shows only the main sections of the route using road names/numbers.

This option also shows the length of each section, time left to next section, arrival time and average direction.

Alternatively, these itinerary/route options can be changed by pressing the "Direction and distance to next change of direction" tab on the display





during route guidance. Press **Options** to change and sort the details of the route.

Refer to (NAVI 50) "Information on the display", "Map screen" in the Usage section ⇨ 78.

Edit route

To edit the route by modifying the list of waypoints, press  followed by **NAVI / Nav, Route** then **Edit Route** on the display screen.

The following options are available:

- Top  : Add waypoint
- Bottom  : Add new destination
-  : Delete destination
-  : Change the route departure address (available depending on version)

To change the order of the waypoints in the list, press **Options** followed by **Re-order** then move the waypoints up/down.

For the various methods of entering a destination, refer to (NAVI 50) "Destination input" ⇨ 97.

Avoidances

To edit the route by avoiding particular sections, press  followed by **NAVI / Nav, Route** then **Avoidances/To avoid** on the display screen.

Select a section from the list on the display screen to be avoided. The avoided section is highlighted in red.

Confirm the new route by pressing **OK**.

Alternative routes

To change the route planning method, press  followed by **NAVI / Nav, Route** then **Alternative routes** on the display screen.

The following options are available, each with a distance and estimated time:

- fast
- short
- eco

Select one of the options and confirm the new route by pressing .

For further information, refer to (NAVI 50) "Setting up the navigation system" in the "Usage" section ⇨ 78.

NAVI 80 - Edit Itinerary

Journeys can be planned in advance by selecting both the starting point and the destination.

From the Home page, press **MENU** then **Navigation**, followed by **Itineraries** on the display screen.

Select a point of departure in the same way as entering a destination. Refer to (NAVI 80) "Destination input" ⇨ 97. Then select a destination, choose the type of route and confirm.

The system plans the route and allows you to view the details.

Change route

To change the route during active route guidance, from the Home page, press **MENU** then **Navigation**, followed by **Change route** on the display screen.

The following options are available:

- **Calculate alternative**
- **Cancel route**
- **Travel via**
- **Avoid roadblock**
- **Avoid part of route**
- **Minimise delays**

Calculate alternative

Select to calculate an alternative route to the destination.

Cancel route

Select to stop the current route guidance.

To restart guidance, press **Drive to...**, followed by **Recent destinations** on the display screen and select the route again.

Travel via (waypoints)

Select to change the calculated route to your destination so that it includes a particular location (waypoint).

The location to be included is entered the same way as entering a destination.

Select from the same list of options, e.g. "Address", "Saved locations", "Point of Interest", "Point on map".

Refer to (NAVI 80) "Destination input" ⇨ 97.

Avoid roadblock

Select this option in the event a roadblock is not currently indicated by the Traffic information service.

Refer to (NAVI 80) "Traffic information" below.

Choose the distance (in metres) of the route ahead to be avoided, e.g. "100m", "500m", "2000m", "5000m".

The route is recalculated to avoid a section of the route for the distance selected.

Avoid part of route

Select to avoid a part of the route. Choose the road to be avoided from the list of roads along the route.

Minimise delays



Select to plan the route based on the latest traffic information.

Deactivating guidance

CD35 BT USB NAVI - Deactivating guidance

To stop guidance when in progress, select **Clear route** (or **Cancel route**) in the main menu and confirm. To resume guidance, select **Navigate to...**, then **Recent destination**.

NAVI 50 - Deactivating guidance

To stop route guidance when in progress, press  followed by  **NAVI** /  **Nav**, **Route** then **Cancel Route** on the display screen.

NAVI 80 - Deactivating guidance

To stop guidance when in progress, press  followed by **Delete route** on the display screen.

Browse map**CD35 BT USB NAVI - Browse map**

Select **Browse map** from the main menu or use one of the direction buttons on the control. The right soft button zooms using the up and down keys. To access the options, press **OK**, then the right soft button.

Options

Access the option from the map browser. This menu allows the selection of information that will be shown on the browser. To change the display preferences for points of interest (POI), press the left soft button. To confirm the selection, press the right soft button.

Find

The map can be centred on a specific location; press the left soft button and this menu can centre:



- your home
- a favourite
- an address
- a recent destination
- a point of interest
- your current location

Cursor position:

To access the **Cursor position:** from the map browser, press **OK**. Use this menu to:

- centre the map on the vehicle location
- navigate to a point on the map
- search for a point on the map
- add a point on the map to the favourites
- add a point on the map to the POI
- correct the location of the vehicle

NAVI 50 - Browse map

To access the map screen at any time, press  followed by  **MAP** on the display screen.

Press anywhere on the map. The cursor indicates the current selected position. To scroll within the map, drag the cursor in the required direction.

For further control operations, refer to (NAVI 50) "Map screen" in the "Usage" section ⇨ 78.

Options menu

When the map screen is displayed, press **Options** to display the following:

- **Route settings:**
Refer to (NAVI 50) "Setting up the navigation system" in the "Usage" section ⇨ 78.
- **Map settings:**
Refer to (NAVI 50) "Setting up the navigation system" in the "Usage" section ⇨ 78.
- **Where am I?:**
Refer to (NAVI 50) "HELP!" below.

NAVI 80 - Browse map

To access the map screen without navigation, on the Home page press **MENU**, then **Navigation** followed by **View Map** on the display screen.

Press anywhere on the map. The cursor indicates the current selected position. To scroll within the map, drag the cursor in the required direction.

When the map screen is displayed, press **+** to open a pop-up menu containing the following options:

- **Use this position to...**
- **Find**
- **Change the map details**
- **Add to saved locations**

Use this position to...

Select this option to perform any of the following actions:

- centre the map on the vehicle's location
- navigate to a point on the map
- search for a point on the map
- add a point on the map to the favourites

- add a point on the map to the POI list
- correct the position of your vehicle

Find

Select this option to centre the map on:

- your home
- a saved address
- an address
- a recent destination
- a local search
- a point of interest
- current vehicle position
- a co-ordinate (latitude/longitude)

Change the map details

Select this option to switch on/off the following map settings:

- traffic
- names
- points of interest (POI)
- satellite image map background
- GPS co-ordinates

Add to saved locations

Select this option to add the current position on the map as a saved destination. Use the keyboard to enter a name or confirm the suggested name.

For keyboard operation, refer to (NAVI 80) "**Operating keyboards in the display**" in the "**Usage**" section ⇨ 78.

Help!

CD35 BT USB NAVI - Help!

Use **Help me!** to find and contact assistance. The following options can be selected:

Emergency phone numbers

The **Emergency phone numbers** menu gives different service centres:

- **Nearest police station,**
- **Nearest doctor,**
- **Nearest hospital,**
- **Nearest public transport,**
- **Nearest car repair services,**
- **Nearest dentist,**

- **Nearest pharmacy,**
- **Nearest vet.**

When a service centre is selected, the location and phone number are displayed. Select the service centre as a destination by pressing the soft button.

Drive to help

Use the system to navigate by road to:

- **Nearest car repair services**
- **Nearest hospital**
- **Nearest doctor**
- **Nearest police station**
- **Nearest pharmacy**
- **Nearest dentist**

Where am I?

The system shows your current location (address) and gives the GPS coordinates (latitude/longitude).

NAVI 50 - Help!

When the map screen is displayed, press **Options** followed by **Where am I?** to check helpful information about the current location and to search for Points of Interest (POI) nearby.

To access the map screen at any time, press  followed by .

Where am I?

This menu option contains the following information:

- current location (address)
- latitude
- longitude
- altitude
- GPS status

Press **Options** to display the following options:

- **Add to favourites**
Refer to (NAVI 50) "Destination input", "Add and save a favourite" for further information .
- **Country information:** Refer to "Country information" below.

Country information

This function allows you to check country information and legislation for the current location.

When the **Where am I?** screen is displayed, press **Options** followed by **Country information** on the display screen.

This menu option contains the following information:

- speed limits
- phone country code (International dialling code, e.g. +49)
- emergency number (e.g. 112)
- legal restrictions, e.g.:
 - vehicle equipment requirements, e.g. warning triangle, first aid kit, fire extinguisher, spare bulbs, high-visibility jacket etc.
 - headlights legislation
 - maximum blood alcohol level
 - snow chains legislation
 - winter tyres legislation

Help Nearby

This function allows you to search for assistance near your current location.

When the **Where am I?** screen is displayed, press **Help Nearby** on the display screen.

This menu option contains the following information:

- **Car repair around here** (Vehicle repair services)
- **Health around here** (Medical and emergency services)
- **Police around here** (Police stations)
- **Petrol/Service station around here** (Fuel stations)

Select the appropriate option to access a list of local Points of Interest (POI).

For information on Points of Interest (POI), refer to (NAVI 50) "Destination input" ⇨ 97.

TomTom Safety Cameras

CD35 BT USB NAVI

The system can provide alerts of safety or speed cameras on route. For options select **TomTom Safety Cameras** in the main menu:

Report safety camera

If the system does not indicate a camera that is on the journey, its details can be entered manually by selecting **Report safety camera**.

The type of camera has to be entered (fixed or mobile). The system opens a map page and using the directional controls, place the red marker on the location of the camera and confirm using the soft buttons.

Confirm the type of camera, and if **Speed camera** is chosen, the speed limit must also be entered and confirmed.

For the system to integrate cameras entered manually by other users, you must be subscribed to the camera updates in **TomTom HOME**. The camera alert will only become active after the location is confirmed by the TomTom technical department.

The quick menu can also be used to report a camera. Select **Report safety camera**. The system requires the type of camera to be entered, then which side of the road it is on. Confirm with the right soft button.

Change warning preferences

Use to delete or modify the warning time before the camera and the sound of the warning.

To add camera alerts (mobile camera, toll road camera etc.), check the types of camera required. Select the type of camera to modify, then to delete the warning, use the soft buttons to confirm yes or no. If No is chosen, enter the warning time before the camera and **Done** using the soft button.

Select the desired sound to warn of an upcoming camera. Test the sound using the left soft button and confirm with the right soft button.

Disable alerts

The camera warnings can be enabled/disabled. Select **Disable alerts** in the main menu if the warnings are enabled or **Enable alerts** if the warnings are disabled.

Note

In certain countries it is illegal to download and activate the camera warning option and this could lead to prosecution.

Traffic information

CD35 BT USB NAVI - Traffic information

Allows up-to-date traffic information from local sources to be received. Traffic information can include:

- accidents and incidents
- traffic volumes
- roadworks
- weather conditions
- lane closures

The **Traffic info** service is not available in all countries and regions.

Traffic incidents are notified by verbal messages and by symbols on the map - refer to "Symbols overview" ⇨ 117.

To show the status of the **Traffic info** service, the following icons are displayed on the traffic sidebar:

- A : The device is searching for an FM station broadcasting traffic information.
- : Traffic information is up-to-date or being updated.

- 🕒 : Information not updated for at least 9 minutes.
- 🕒 : Information not updated for at least 14 minutes.
- 🕒 : Information not updated for at least 19 minutes.
- 🕒 : Information not updated for at least 24 minutes.

To manage the **Traffic info** service, select **Traffic info** (or **HD Traffic**) from the main menu and select from the following options:

Minimise traffic delays

Select this menu to plan the route based on the latest traffic information.

Show traffic on route

Select this menu to see an overview of all traffic incidents on the route. Use the soft buttons on the resulting screen to see more detailed information about each incident.

Browse map

This menu enables the map to be explored and to keep up-to-date with the traffic situation in the area. The map displays the last location shown.

For information relating to the incidents shown on the map, select the incident using the right and left buttons, then confirm.

To access an area you are searching for more quickly, add it to your favourites.

Change Traffic info preferences

The following can be changed:

- automatically minimise delays after every traffic update
- beep to notify when traffic situation on route changes

Read aloud traffic info

Select this menu for traffic incidents to be read aloud on the route.

NAVI 50 - Traffic information





Available depending on version, up-to-date traffic information from local sources can be received. Information is provided for the current route or for the current vehicle location.

During route guidance, press **Options** then select **Current traffic**, or press the traffic icon 🗨️ on the map

screen. Traffic incidents along the route and estimated delay times are displayed.

The following options are available:

- **Event list:** Select to change event display settings.
- **Offer detour:** Create an alternative route to the selected destination.
- **Options:** Access traffic options.

To access these traffic options at any time, press  followed by  **NAVI** /  **Nav** then **Options**. Then select  **Traffic**.

Press  to return to route guidance.

NAVI 80 - Traffic information

Allows up-to-date traffic information from local sources to be received.

From the Home page, press **MENU** then **Navigation**, followed by **Traffic/HD Traffic** on the display screen.

The navigation system indicates traffic incidents with voice messages, the traffic information bar and also by displaying symbols on the map.

Refer to "Symbols overview" ⇨ 117.

The system receives updates approx. every 15 minutes and traffic incidents are shown for major roads only.

The **Traffic** service is named **HD Traffic** if a subscription to LIVE services has been activated. With **HD Traffic**, updates are received approx. every 3 minutes and traffic incidents are shown for minor roads also.

For further information, refer to (NAVI 80) "LIVE services" in the "Usage" section ⇨ 78.

Depending on the current traffic situation, the traffic information bar can include the following information:

- heavy delays on the route (given in minutes)
- unknown or indeterminate situation (grey)
- slow traffic (orange)
- traffic jam (red)
- stationary traffic or road closed (dark red)
- distance before next incident (in km/miles)











To manage the Traffic information service, select from the following options:

- **Minimise delays**
Alter journey based on the latest traffic information.
- **Display traffic on route**
Displays an overview of all traffic incidents on the current route. Press incident icons for more detailed information.
- **Explore map**
Select to explore the map and stay up-to-date with the traffic situation in the area.
The map displays the last searched location. Press incident icons for more detailed information.
- **Read traffic information aloud during the route**
Activates voice guidance for traffic information.

Traffic service settings

Select **Traffic Settings** and tick the box alongside the required preferences (e.g. automatically minimise delays after every traffic update) and select **Done** to confirm.

Symbols overview

-  : Accident
-  : Traffic jam
-  : One or more lanes closed
-  : Road closed
-  : Traffic incident
-  : Road works
-  : Heavy rain
-  : Snow
-  : Strong wind, storm
-  : Fog
-  : Ice

Voice recognition

General information 118
Navigation control 120
Phone control 120

General information

The voice recognition function allows you to operate certain functions via voice input.

To ensure that conversations held inside the vehicle do not start unintentional calls to a saved contact, the voice recognition function must first be activated via  on the steering column controls.

Control elements overview ⇨ 6.

CD35 BT USB

The voice recognition function of the handsfree phone system allows you to operate certain functions of the mobile phone via voice input.



Voice tags can be created for the contacts in the vehicle phonebook enabling you to call a contact without manually selecting the caller name or number.

In the event of incorrect operation, the voice recognition function requests you to repeat the desired command, or plays back the available options.

NAVI 50

Available depending on version, the voice recognition function of the handsfree phone system allows you to operate certain functions of a compatible smartphone via voice input.

Refer to "Phone control" in this section ⇨ 120.

To confirm that a paired and connected smartphone is compatible with the voice recognition function, press  followed by  **Setting** on the display screen.

Then select **Bluetooth** followed by **View Bluetooth device list**. The list shows the paired devices and  appears alongside the name of the smartphone to indicate compatibility.

Note

If supported, the language set on your smartphone will automatically be used by the Infotainment system for voice recognition.



The navigation system can also be operated using voice controls. Refer to "Navigation control" in this section ⇨ 120.



Prerequisites

The following prerequisites must be met:

- The Bluetooth function of the Infotainment system must be activated.
Refer to "Bluetooth connection" in the "Phone" section ⇨ 127.
- The Bluetooth function of the Bluetooth-enabled smartphone must be activated and the smartphone must have a 3G, 4G or wi-fi connection (see smartphone operating instructions).
- Dependent upon the smartphone, it may be required to set the device to "visible" (see smartphone operating instructions).
- The smartphone must be paired and connected to the Infotainment system.

Help

For information and help with activating and operating voice controls, press  followed by  **Setting** then **Bluetooth** on the display screen.

Select **Smartphone** from the list (press / to search list), then press  to access help.

A series of screens are displayed, explaining how to use the voice recognition function and information on the following:

- switching on/off with steering column controls
- compatible phones
- operation methods
- available functions and descriptions
- conditions of use

NAVI 80

The voice recognition function allows you to operate certain functions via voice input, including:

- **Navigation**

Refer to "Navigation control" in this section ⇨ 120.

- **Phone**



Refer to "Phone control" in this section ⇨ 120.

- **Applications**

Press  on the steering column controls to open the **Voice control** main menu. After the tone, say "**Applications**" followed by the name of the desired application to start it.

When activated, the **Voice control** main menu is displayed and the voice recognition indicator in the top right corner indicates system status and optimisation levels:

Green : optimal voice recognition
Orange : good voice recognition
Red : average voice recognition



- Microphone  : System is ready to receive a voice command
- Loudspeaker  : Voice instructions are currently being given by the system
- Loading icon  : Data currently loading

Navigation control

NAVI 50

Activating voice recognition

To activate the voice recognition function during navigation:

Press  on the steering column controls;  appears, alongside the audio system information, in the bottom right corner of the display.

Note

During use of the voice recognition function, audio source playback is interrupted.

For a guide to using voice commands, refer to (NAVI 50) "Help" in the "General information" section ⇨ 118.

NAVI 80

Activating voice recognition

To activate the voice recognition function:

Press  on the steering column controls to open the **Voice control** main menu.

After the tone, say "**Destination**" to enter a new address. Say "**Address**" then say the full destination of a new address (number, street name, destination town/city).

The address recognised by the system is displayed. Confirm destination when prompted to begin guidance.

Alternatively, after the tone say "**Recent destinations**" to access a list of the most recent destinations entered and select the desired destination.

For further information, refer to (NAVI 80) "Destination input" in the "Navigation" section ⇨ 97.

Phone control

CD35 BT USB

Creating voice tags

In addition to names and numbers, voice tags can be created when new contacts are added to the vehicle phonebook. Refer to "Operation" in the "Phone" section ⇨ 131.

Voice tags can also be added or modified afterwards by selecting the following menus and options:

- **Directory Management**
- **Vehicle phonebook**
- **Modify this contact**

Select the contact to be modified from the list of contacts, then select the following menu options by turning and pressing the rotary knob:

- **(voice tag)**
- **Launch voice tag recording**

When prompted to record a voice tag, speak after the tone. A message asks for the voice tag to be repeated. If the system does not recognise the repeated voice tag, it will request it to

be repeated again. A message confirms that the voice tag has been recorded successfully.

Upon completion, ensure the voice tag is stored along with other contact details by selecting **Memorise**.

Activating voice recognition

To activate the voice recognition function:

Press $\mathbb{3}$ on the steering column controls

After the tone, repeat the voice tag previously recorded for the desired contact to start the dialling process.

Say the voice tag directly, i.e. do not say 'Call' before the voice tag.

If the system does not recognise the voice tag, a message asks you to repeat it. If the voice tag is still not recognised, the list of recorded voice tags is played back. Repeat the desired voice tag when it is played back, to start the dialling process.

In the event the system still does not recognise the voice tag, the voice recognition function is automatically deactivated.

NAVI 50

Activating voice recognition

To activate the voice recognition function:

Press $\mathbb{3}$ on the steering column controls to open the **Smartphone** menu; a beep sounds and $\mathbb{3}$ appears on the display, indicating activation.

To use voice recognition, press $\mathbb{3}$ on the display (or press $\mathbb{3}$).

Note

During operation of the voice recognition function, **Radio** and **Media** functions are not available for use.

To deactivate, press and hold $\mathbb{3}$ on the display (or press $\mathbb{3}$).

For a guide to using voice commands, refer to (NAVI 50) "Help" in the "General information" section ↻ 118.

NAVI 80

Activating voice recognition

To activate the voice recognition function:

Press $\mathbb{3}$ on the steering column controls to open the **Voice control** main menu.

After the tone, say "**Phone**" to access the Phone menu. Say the name of a saved contact or a telephone number. The desired contact appears in the display when registered by the system.

Say "**Call**" to start the dialling process.

Say "**Delete**" to cancel input and retry.

Alternatively, to initiate a call directly from the **Voice control** main menu, press $\mathbb{3}$ and say the name of a saved contact or a telephone number.

Phone

General information	122
Connection	124
Bluetooth connection	127
Emergency call	131
Operation	131
Mobile phones and CB radio equipment	140

General information

The handsfree phone system provides you with the possibility of having mobile phone conversations via the vehicle's microphone and loudspeakers, as well as operating the most important mobile phone functions via the Infotainment system.

To be able to use the handsfree phone system, the mobile phone must be connected with it via **Bluetooth**.

Not all handsfree phone system functions are supported by every mobile phone. The possible phone functions depend on the relevant mobile phone and network provider. Refer to the operating instructions for your mobile phone or consult your network provider.

Important information for operation and traffic safety

Warning

Use of the handsfree phone system while driving can be dangerous as your concentration is reduced when telephoning. Park the vehicle before using the handsfree phone system.

Follow the regulations of the country in which you are driving.

Also follow the special regulations that apply in specific areas and always switch off the mobile phone if the use of mobile phones is prohibited, if interference is caused by the mobile phone or if dangerous situations can occur.

Warning

Mobile phones have effects on your environment. For this reason, safety regulations have been

prepared which you should make yourself familiar with before you use the telephone.



Bluetooth

The Phone portal is certified by the Bluetooth Special Interest Group (SIG).



You will find further information about the specification on the Internet at <http://www.bluetooth.com>

Phone controls

Controls on Infotainment system or steering column:

-  **TEL**
- or -
- **TEL**
- or -
-  **PHONE** on the  Home menu screen (NAVI 50)
- or -
PHONE in the MAIN menu screen (NAVI 80)
Press to open the **Phone** menu.

Controls on steering column:

- , : Take call, end/reject call.
- or -
- **MODE/OK**: Take call, end/reject call, confirm an action.
- : Activate/deactivate voice recognition.

Depending on Infotainment system, some features of the handsfree phone system can also be operated via voice recognition  120.

Display screen operation



R15 BT USB, R16 BT USB, CD16 BT USB, CD18 BT USB - Display screen operation

- To move up/down in the display: Turn **OK**.
- To confirm actions: Press **OK**.
- To cancel actions (and return to previous menu): Press .

CD35 BT USB - Display screen operation

- To move up/down in the display: Turn the central rotary knob.
- To confirm actions: Press the central rotary knob.
- To cancel actions (and return to previous menu): Press .





NAVI 50 - Display screen operation

To access the Phone menu screen, press  followed by  **Phone** on the display screen.

The following submenus are available:

- **Phone book**
- **Calling Lists**
- **Dial**

To switch between submenus, press  in top left corner.

- To move up/down in the display: Press  or .
- To confirm actions: Press **OK**.
- To cancel actions (and return to previous menu/Home page): Press /.

NAVI 80 - Display screen operation

To access the "Phone" menu from the Home page, press **MENU** followed by **Phone** on the display screen.

The following submenus are available:

- **Phonebook**
- **Call logs**
- **Dial a number**
- **Voice mail**
- **Settings**
- To move up/down in the display: Press **↕** or **↘**.
- To cancel actions (and/or return to previous menu): Press **←**.
- To open a pop-up menu (e.g. to add contacts to a list of favourites): Press **+**

Note

Favourites can be accessed at any time by pressing **★** on the Home page.

Operating keyboards in the display**R15 BT USB, R16 BT USB, CD16 BT USB, CD18 BT USB - Operating keyboards in the display**

To move within and to enter characters in the numerical keyboard shown on the display screen: Turn and press **OK**.

Entries can be corrected during input with the **←** keyboard character.

Press **→** to stop using the keyboard and return to the previous screen.

CD35 BT USB - Operating keyboards in the display

To move within and to enter characters in both the alphabetical and numerical keyboards shown on the display screen: Turn and press the central rotary knob.

Entries can be corrected during input with the **←** keyboard character.

Press **→** to stop using the keyboard and return to the previous screen.

NAVI 50, NAVI 80 - Operating keyboards in the display

To move within and to enter characters in the numerical keyboard, make the appropriate selection by touching the display screen.

Entries can be corrected during input with the **✖** keyboard character.

Press **←** to stop using the keyboard and return to the previous screen.

Connection

A mobile phone must be connected to the handsfree phone system in order to control its functions via the Infotainment system.

No phone can be connected to the system unless it has first been paired. Refer to the **Bluetooth connection** section (↪ 127) for pairing a mobile phone to the handsfree phone system via Bluetooth.

When the ignition is switched on, the handsfree phone system searches for paired phones in the vicinity.

Bluetooth must be activated on the mobile phone for the phone to be recognised by the handsfree phone

system. Searching continues until a paired phone is found. A display message indicates that the phone is connected.

Note

When a Bluetooth connection is active, using the handsfree phone system will discharge the mobile phone battery more rapidly.

Automatic connection

For your phone to connect automatically when the system is switched on, it may be necessary to activate the automatic **Bluetooth** connection function on your mobile phone; refer to the mobile phone operating instructions.

Note

Depending on Infotainment system, when reconnecting to a paired phone, or when 2 paired phones are within range of the handsfree phone system, either the priority phone (if defined) or the last connected phone is connected automatically, even if this phone is outside the vehicle but still within range of the handsfree phone system.

During automatic connection, if a call is already in progress, the conversation will automatically switch to the vehicle's microphone and loudspeakers.

If connection fails:

- check the phone is switched on
- check the phone battery is not flat
- check if the phone has already been paired

The Bluetooth function on the mobile phone and on the handsfree phone system must be active and the mobile phone must be configured to accept the system connection request.

Manual connection

R15 BT USB, R16 BT USB, CD16 BT USB, CD18 BT USB - Manual connection

To change the phone connected to the handsfree phone system, press **TEL** and select the **Select Device** menu. The device list shows the phones already paired.



Select the desired phone from the list and confirm by pressing **OK**. A display message confirms phone connection.

CD35 BT USB - Manual connection

To change the phone connected to the handsfree phone system, press **SETUP / TEXT** and select **Bluetooth connection** (or press **TEL** when no device is connected). The device list shows the phones already paired.

Select the desired phone from the list and confirm by turning and pressing the central rotary knob. A display message confirms phone connection.

NAVI 50 - Manual connection

To change the phone connected to the handsfree phone system, press  followed by  **SETTINGS** then **Bluetooth** on the display screen (or select **Phone** from the Home page).

Then select **View Bluetooth device list**. The device list shows the phones already paired.

Select the desired phone from the list and confirm by pressing **OK**.

Depending on version, appears alongside the selected phone, to indicate connection.

NAVI 80 - Manual connection

To change the phone connected to the handsfree phone system, from the Home page, press **MENU** then **Phone** followed by **Settings** on the display screen.

Then select **Manage devices**. The device list shows the phones already paired. Select the desired phone from the list.

Disconnecting a phone

If the mobile phone is switched off, the phone is automatically disconnected from the handsfree phone system.

During disconnection, if a call is already in progress, the conversation will automatically switch to the mobile phone.

R15 BT USB, R16 BT USB, CD16 BT USB, CD18 BT USB - Disconnecting a phone

To disconnect a phone from the Infotainment system, press **TEL** (or the **SETUP**) and select **Bluetooth connection**. Select the desired device from the device list then select **Disconnect the device** by turning and pressing **OK**. A display message confirms phone disconnection.

CD35 BT USB - Disconnecting a phone

To disconnect a phone from the Infotainment system, press **SETUP / TEXT** and select **Bluetooth connection**. Select the desired device from the device list then select **Disconnect the device** by turning and pressing the central rotary knob. A display message confirms phone disconnection.

NAVI 50 - Disconnecting a phone

Depending on version, to disconnect a phone from the Infotainment system, press **⌘** followed by

⌘SETTINGS then **Bluetooth** on the display screen (or select **☰Phone** from the Home page).

Then select **View Bluetooth device list** and press on the connected phone shown in the displayed list to disconnect it; appears alongside the phone, to indicate disconnection.

NAVI 80 - Disconnecting a phone

To disconnect a phone from the Infotainment system, from the Home page, press **MENU** then **Phone** followed by **Settings** on the display screen.

Then select **Manage devices**. Select the connected phone in the displayed list to disconnect.

Defining the priority phone

R15 BT USB, R16 BT USB, CD16 BT USB, CD18 BT USB - Defining the priority phone

The priority phone is the last connected phone.

When the ignition is switched on, the handsfree phone system searches first for the priority paired phone. Searching continues until a paired phone is found.

CD35 BT USB - Defining the priority phone

The priority phone is the last connected phone.

When the ignition is switched on, the handsfree phone system searches first for the priority paired phone. Searching continues until a paired phone is found.

Bluetooth connection

Bluetooth is a radio standard for the wireless connection of, e.g., a telephone with other devices.

Information such as a mobile phone contact list and call lists can be transferred. The functionality can be restricted depending on the phone model.

Prerequisites

The following prerequisites must be met, in order to control a Bluetooth-enabled mobile phone via the Infotainment system:

- The Bluetooth function of the Infotainment system must be activated.
- The Bluetooth function of the Bluetooth-enabled mobile phone must be activated (see mobile phone operating instructions).
- Dependent upon the mobile phone, it may be required to set the device to "visible" (see mobile phone operating instructions).
- The mobile phone must be paired and connected to the Infotainment system.

Activating Bluetooth function of the Infotainment system

R15 BT USB, R16 BT USB, CD16 BT USB, CD18 BT USB - Activating Bluetooth

To enable the Infotainment system to recognise and operate a Bluetooth-enabled mobile phone, the Bluetooth function must first be activated. Deactivate the function if not required.

Press **TEL** and select **Bluetooth** by turning and pressing **OK**.

Select **ON** or **OFF** and confirm by pressing the knob.

CD35 BT USB - Activating Bluetooth

To enable the Infotainment system to recognise and operate a Bluetooth-enabled mobile phone, the Bluetooth function must first be activated. Deactivate the function if not required.

Press **SETUP / TEXT** and select **Phone settings** by turning and pressing the central rotary knob.

Select **Bluetooth activated** or **Bluetooth deactivated** and confirm by pressing the knob.

NAVI 50 - Activating Bluetooth

Press **☰** followed by **⚙️SETTINGS** on the display screen.

Select **Bluetooth** to display the following options:

- **View Bluetooth device list**
- **Search for Bluetooth device**
- **External device authorisation**
- **Change passkey**
- **Smartphone**

Available depending on version. For help with activating and operating voice controls - refer to "Voice recognition" ⇨ 118).

When the **Bluetooth** screen is displayed, Bluetooth-enabled devices can be paired to the Infotainment system.

NAVI 80 - Activating Bluetooth

To access the Phone settings menu from the Home page, press **MENU** then **Phone** followed by **Settings** on the display screen.

The following options are displayed:

- **Manage devices**
- **Sound levels**
- **Voice mail**
- **Turn Bluetooth on/off**
- **Automatically download phone data (on/off)**

Press **Turn Bluetooth on** to tick the box alongside it. Bluetooth-enabled devices can now be paired to the Infotainment system.

Refer to (NAVI 80) "Phone settings" in the "Operation" section for further information ⇨ 131.

Pairing a mobile phone to the handsfree phone system

In order to use your handsfree phone system, a connection must be set up between the mobile phone and the system via **Bluetooth**, i.e. the mobile phone must be paired to the vehicle before using it. For this purpose, the mobile phone must support Bluetooth. Refer to the operating instructions for your mobile phone.

To set up a Bluetooth connection, the handsfree phone system must be switched on and Bluetooth must be activated on the mobile phone.

Note

If another phone is automatically connected during a new pairing procedure, it will automatically be disconnected, to allow the new pairing procedure to continue.

Pairing enables the handsfree phone system to recognise and store a mobile phone in the device list. A maximum of 5 mobile phones can be paired and stored in the device list, but only one can be connected at a time.

Note

Depending on version of NAVI 50, a maximum of 8 mobile phones can be paired.

When pairing is completed, a message with the name of the paired phone is shown on the Infotainment system display screen and the phone is automatically connected to the

handsfree phone system. The mobile phone can then be operated via the Infotainment system controls.

Note

When a Bluetooth connection is active, using the handsfree phone system will discharge the mobile phone battery more rapidly.

R15 BT USB, R16 BT USB, CD16 BT USB, CD18 BT USB - Pairing a mobile phone

To pair a phone to the handsfree phone system, press **TEL** and select **Pair device** by turning and pressing **OK**. The **Ready to Pair** screen is displayed.

On the mobile phone, search for Bluetooth equipment in the vicinity of the device.

Select **My Radio** (i.e. the name of the handsfree phone system) from the list on the mobile phone, then, on the mobile phone keypad, enter the pairing code shown on the Infotainment system display screen.

If pairing fails, the system returns to the previous menu and a corresponding message is displayed. Repeat procedure if necessary.

CD35 BT USB - Pairing a mobile phone

To pair a phone to the handsfree phone system, press **SETUP / TEXT** and select **Bluetooth connection** from the settings menu. Select an empty slot by turning the central rotary knob and press the knob to display the next menu.

Select **Pair phone** by turning and pressing the central rotary knob, then, on the mobile phone, search for Bluetooth equipment in the vicinity of the phone.

Select **My_Radio** (i.e. the name of handsfree phone system) from the list on the mobile phone, then on the mobile phone keypad enter the pairing code shown on the Infotainment system display screen.

If pairing fails, the message **Pairing failed** is displayed. Repeat procedure if necessary.

NAVI 50 - Pairing a mobile phone

Press **☰** followed by **⚙️SETTINGS** on the display screen.

Select **Bluetooth** then either **Search for Bluetooth device** or **External device authorisation**.

Alternatively, when in the **Phone** menu screen, press **☎** on the display.

On the mobile phone, search for Bluetooth equipment in the vicinity of the device.

Select the name of the handsfree phone system (e.g. **MEDIA-NAV**) from the list on the mobile phone, then (if required), on the mobile phone keypad, enter the pairing code shown on the Infotainment system display screen.

Note

The pairing code may only be shown on the Infotainment system display for a limited time.

The default pairing code is **0000**. To change this pairing code before the pairing procedure is started, select **Change passkey** to update.

If pairing fails, repeat procedure if necessary.

NAVI 80 - Pairing a mobile phone

To access the Phone settings menu from the Home page, press **MENU** then **Phone** followed by **Settings** on the display screen.

Select **Manage devices** from the list of options. A message appears on the display asking if you wish to set up a Bluetooth connection between your device and the Infotainment system. Select **Yes** to continue. The Infotainment system begins a search for Bluetooth equipment in the vicinity and displays a list of devices.

Select your device from the displayed list. Depending on phone model, confirm the pairing request or enter the pairing code on the mobile phone keypad to pair it to the Infotainment system.

To pair further devices, from the **Manage devices** screen, press **+** to open a pop-up menu and select **Add** to pair additional devices in the same way.

If pairing fails, repeat procedure if necessary.

Unpairing a mobile phone from the handsfree phone system

If the list of paired phones is full, a new phone can only be paired if an existing phone is unpaired.

Note

Unpairing a phone erases all of its downloaded contacts and its call history from the handsfree phone system phonebook.

R15 BT USB, R16 BT USB, CD16 BT USB, CD18 BT USB - Unpairing a mobile phone

To unpair, i.e. to delete a phone from the handsfree phone system memory, press **TEL** and select **Delete device**.

Select the desired phone from the device list and press **OK** to confirm deletion when prompted.

CD35 BT USB - Unpairing a mobile phone

To unpair, i.e. to delete a phone from the handsfree phone system memory, press **SETUP / TEXT** and select **Bluetooth connection** from the settings menu.

Select the desired phone from the device list, press the central rotary knob and select **Delete**.

NAVI 50 - Unpairing a mobile phone

To unpair, i.e. to delete a phone from the handsfree phone system memory, press **⌘** followed by **⚙️SETTINGS** on the display screen.

Select **Bluetooth** then **View Bluetooth device list**.

Select the desired phone from the device list, then press **⌘** to delete the device. If required, delete all devices in the list by pressing **Options** followed by **Delete all**. Confirm by pressing **OK**.

NAVI 80 - Unpairing a mobile phone

To unpair, i.e. to delete a phone from the handsfree phone system memory, access the **Manage devices** screen.

From the Home page, press **MENU** then **Phone** followed by **Settings** on the display screen.

Select **Manage devices**, then press **+** to open a pop-up menu, select **Delete** and remove the selected device from the list.

Emergency call

Warning

Connection setup cannot be guaranteed in all situations. For this reason, do not rely exclusively on a mobile phone when a vitally important communication (e.g. a medical emergency) is concerned.

On some networks, it may be necessary for a valid SIM card to be properly inserted in the mobile phone.

Warning

Bear in mind that you can only make and receive calls with the mobile phone if it is in a service area with a sufficiently strong signal.

Under certain circumstances, emergency calls cannot be made on all mobile phone networks; it is also possible that emergency calls cannot be made when certain network services and/or telephone functions are active. Consult your network provider for more information.

The emergency call number differs depending on country or region. Please enquire beforehand about the correct emergency call number for the relevant country or region.



Dial the emergency call number (refer to "Operation" ⇨ 131); A telephone connection to the emergency call centre is set up.

Answer when the service personnel questions you about the emergency.

Warning

Do not end the call until you are requested to do so by the emergency call centre.

NAVI 50

To view the emergency number for the current location, press  followed by  **MAP** (available depending on version) on the display screen.

Press **Options** then **Where am I?**

When the **Where am I?** screen is displayed, press **Options** followed by **Country information** on the display screen: Emergency number (e.g. 112) is shown on the display.

Operation

Introduction

When a Bluetooth connection has been set up between your mobile phone and the handsfree phone system, certain functions of your mobile phone can be operated via the Infotainment system controls or display.

It is then possible, e.g., to import the contacts and telephone numbers stored in your mobile phone into the handsfree phone system.



After connection, the mobile phone data is transmitted to the handsfree phone system. This can take some time, depending on phone model. During this period, operation of the mobile phone is possible via the Infotainment system only to a limited extent.

Note

Not every mobile phone supports the functions of the handsfree phone system. Therefore, deviations from the range of functions described are possible.



Phone menu

To display the **Phone** menu:

- press  **TEL**
- or -
- press **TEL**
- or -
- press  followed by  **Phone** on the display screen (NAVI 50)
from the Home page, press **MENU** followed by **Phone** on the display screen (NAVI 80)

Volume control



R15 BT, R16 BT USB, CD16 BT, CD18 BT USB - Volume control

During a call, turn  or press  or  (on the steering column controls) to change the call volume.



CD35 BT USB - Volume control



To preset the volume for calls, voice recognition or the ringtone, press **SETUP / TEXT** and select **Phone settings** from the settings menu, followed by **Volume**.

Select the desired option (e.g. **Ringing volume**) and adjust the volume with the central rotary knob.

During a call, turn volume rotary knob or press  or  (on the steering column controls) to change the call volume.



NAVI 50 - Volume control

During a call, press  or  on the Infotainment unit to change the call volume.

Alternatively (with the steering column controls), press  or .

NAVI 80 - Volume control

During a call, turn  on the Infotainment unit to change the call volume.

Alternatively (with the steering column controls), press  or .



Dialling a telephone number

Several options are available for dialling telephone numbers, including calling a contact from the phonebook or from a call log. Numbers can also be dialled manually.

Entering a number manually

R15 BT USB, R16 BT USB, CD16 BT USB, CD18 BT USB - Entering a number manually

With the **Phone** menu displayed, select **Dial** from the list.

Enter the desired number using the numerical keyboard ( 122) and select  to start dialling.

To redial the last number, press and hold **TEL**.

CD35 BT USB - Entering a number manually

With the **Phone** menu displayed, select **Dial a number** from the list.



Enter the desired number using the numerical keyboard (↔ 122) then select the  icon in the display. Press the central rotary knob to start dialling.

NAVI 50 - Entering a number manually

With the  **Phone** menu displayed, press **▼** in top left corner and select **Dial** from the list.

Enter the desired number using the numerical keyboard and select  to start dialling.

Refer to (NAVI 50) "Operating keyboards in the display" in the "General information" section ↔ 122.

Entries can be corrected during input with the  keyboard character. Press and hold  to delete all numbers at once.

NAVI 80 - Entering a number manually

From the Home page, press **MENU** then **Phone** followed by **Dial a number** on the display screen

Enter the desired number using the numerical keyboard and press **Call** to start dialling.

Entries can be corrected during input with the  keyboard character.

Phonebook

The phonebook contains contact lists available only to the current vehicle user. For reasons of confidentiality, each downloaded contacts list can only be viewed when the corresponding phone is connected.

R15 BT USB, R16 BT USB, CD16 BT USB, CD18 BT USB - Phonebook

After pairing the mobile phone to the Infotainment system, the contact list in the mobile phone is downloaded to the handsfree phone system.

To dial a number from the phonebook, with the **Phone** menu displayed, select **Phonebook** and

select the desired contact from the alphabetical list. Press **OK** to start the dialling process.

CD35 BT USB - Phonebook

After setting up the connection, the contact list in the mobile phone is downloaded to the handsfree phone system. Each time the phone is connected, the system's phonebook is updated automatically.

The telephone book can also be updated manually while the phone is connected by selecting the **Phone settings** menu followed by **Update**. Select the **Update** option and confirm by turning and pressing the central rotary knob.

A maximum of 500 contacts and 4 numbers per contact can be downloaded. If the memory capacity is exceeded, a prompt to delete excess contacts will appear. Deleted contacts will remain on the mobile phone, but are deleted from the system memory.

Dialling a number from the phonebook

To dial a number from the phonebook, with the **Phone** menu displayed, select **Phone settings** to display the contacts list.

Select the first letter of the desired name by turning the central rotary knob. Press the knob to display the contacts listed for that letter, if applicable.

Turn rotary knob to select desired contact and press knob to display the corresponding details. Select the relevant number for the contact and press knob to start the dialling process.

Adding contacts to the phonebook

Contacts can be added to the phonebook by selecting the following menu options:

- **Phone settings**
- **Add contact**

Use the alphabetical and numerical keyboards (↔ 122) to enter a name and up to 4 numbers for the new contact.

Incorrect names and numbers entered via the keyboards can also be deleted during contact creation.

NAVI 50 - Phonebook

After pairing the mobile phone to the Infotainment system, the contact list in the mobile phone is downloaded to the handsfree phone system.

With the **Phone** menu displayed, press ▼ in top left corner and select **Phone book** from the list.

To dial a number from the phonebook, select the desired contact from the list.

Alternatively, press **Search by Name** in the display, then enter the name of the desired contact using the keyboard.

Refer to (NAVI 50) "Operating keyboards in the display" in the "General information" section ↔ 122.

NAVI 80 - Phonebook

After pairing the mobile phone to the Infotainment system, the contact list in the mobile phone is downloaded to the handsfree phone system.

Note

Data sharing must be authorised on your phone. Refer to the operating instructions for your mobile phone or consult your network provider.

The feature "Automatically download phone data" must also be switched on in the Infotainment phone settings menu. Refer to (NAVI 80) "Phone settings" below.

From the Home page, press **MENU** then **Phone** followed by **Phone book** on the display screen

To dial a number from the phonebook, select the desired contact from the list. If a contact has more than one saved number, select the appropriate number when prompted.

After the initial pairing of the phone with the Infotainment system, the system can be updated with the latest contacts on your mobile phone. Press **+** to open a pop-up menu and select **Update telephone data**. If necessary, select **Help** from the pop-up menu for assistance.

To add a contact to your list of favourites, press **+** and select **Add a contact to the Favourites page**.

Note

Favourites can be accessed at any time by pressing **★** on the Home page.

For further information, refer to (NAVI 80) "Favourites" in the "Introduction" section ⇨ 24.

Call lists

R15 BT USB, R16 BT USB, CD16 BT USB, CD18 BT USB - Call lists

To dial a number from the call history lists (e.g. dialled numbers, received calls, missed calls), select the relevant option, e.g. **Recent calls** from the **Call list** menu. Select the desired contact and press **OK** to start the dialling process.

CD35 BT USB - Call lists

To dial a number from the call history lists (e.g. dialled numbers, received calls, missed calls), select the relevant option, e.g. **Dialled calls** from

the **History** menu. Select the desired contact and press the central rotary knob to start the dialling process.

NAVI 50 - Call lists

After connecting the mobile phone to the Infotainment system, the list of dialled numbers, received calls and missed calls in the mobile phone are transferred automatically to the handsfree phone system.

With the **Phone** menu displayed, press **▼** in top left corner and select **Calling Lists** from the list.

To dial a number from the call history lists, select from the following options on the display:

- **All**: Displays list of all calls in the below lists.
- **Dialled numbers**.
- **Received calls**.
- **Missed calls**.

Note

The number of missed calls is shown alongside the symbol.

The most recent calls are displayed at the top. Select the desired contact from the chosen list to start the dialling process.

NAVI 80 - Call lists

After connecting the mobile phone to the Infotainment system, the list of dialled numbers, received calls and missed calls in the mobile phone are transferred automatically to the handsfree phone system.



Note



Data sharing must be authorised on your phone. Refer to the operating instructions for your mobile phone or consult your network provider.

The feature "Automatically download phone data" must also be switched on in the Infotainment phone settings menu. Refer to (NAVI 80) "Phone settings" below.

From the Home page, press **MENU** then **Phone** followed by **Call logs** on the display screen.

To dial a number from the call history lists, select from the following options on the display:

- **All**: Displays list of all calls in the below lists.
- : Received calls.
- : Missed calls.
- : Dialed numbers.

The most recent calls are displayed at the top. Alternatively, press  or  to move up/down in the display.

Select the desired contact from the chosen call list to start the dialling process.

Note

If necessary, press  (to open a pop-up menu) and select **Update telephone data** to update the call lists.

Voicemail box

R15 BT USB, R16 BT USB, CD16 BT USB, CD18 BT USB, CD35 BT USB - Voicemail box

To listen to mobile phone voicemail messages via the Infotainment system while the phone is connected, select the **Voicemail box** menu.

NAVI 80 - Voicemail box



To listen to mobile phone voicemail messages via the Infotainment system while the phone is connected, from the Home page, press **MENU** then **Phone** followed by **Voice mail** on the display screen.

The configuration screen will be displayed if the voicemail box is not configured. Enter number on the numerical keyboard and confirm.



Receiving calls

R15 BT USB, R16 BT USB, CD16 BT USB, CD18 BT USB - Receiving calls

To accept the call, depending on vehicle configuration:

- Briefly press  (on the steering column controls).
- Select the  icon in the display (by turning and pressing **OK**).

To reject the call, depending on vehicle configuration:

- Press and hold  (on the steering column controls).
- Select the  icon in the display (by turning and pressing **OK**).

When receiving a call, the caller number may be shown on the Infotainment system display screen. If the number is stored in the system memory, the name is displayed instead. If the number cannot be displayed, the message **Private number** is shown.

CD35 BT USB - Receiving calls

To accept the call, briefly press  (on the steering column controls).

To reject the call:

- press and hold  (on the steering column controls), or
- select **Refuse** in the display (by turning and pressing the central rotary knob)

When receiving a call, the caller number may be shown on the Infotainment system display screen. If the number is stored in the system memory, the name is displayed instead. If the number cannot be displayed, the message **Unknown** is shown.

The handsfree phone system ringtone is dependent upon the phone model and mode (silent, vibrate, etc.).

Automatic call waiting

For safety reasons, the automatic call waiting function is set by default. It is recommended that this feature remains activated.

When an incoming call arrives, a message alerts the caller to the fact that you are driving. The call starts automatically and the length of the call is shown on the Infotainment system display screen. Pick up the call only when it is safe to do so.

To deactivate automatic call waiting, refer to (CD35 BT USB) "Activate/deactivate automatic call waiting" in the "Phone settings" section.

With automatic call waiting deactivated, it is possible to reject the call by selecting **Refuse** or by pressing and holding . To place the caller on hold, select **Pause**; the caller is informed they are on hold via an automatic message.

Temporarily override the automatic call waiting feature by selecting **Resume** or press  to receive the call.

NAVI 50 - Receiving calls

To accept the call:

- Press **Accept/Agree** on the display screen.
- Briefly press  (on the steering column controls).

To reject the call:

- Press **Refuse/Reject** on the display screen.
- Press and hold  (on the steering column controls).

When receiving a call, the caller number may be shown on the Infotainment system display screen. If the number is stored in the system memory, the name is displayed instead. If the number cannot be displayed, the message **Unknown/Unknown number** is shown.

NAVI 80 - Receiving calls

To accept the call:

- press **Pick up** on the display screen
- briefly press  (on the steering column controls)

To reject the call:

- press **Reject** on the display screen
- press and hold  (on the steering column controls)

When receiving a call, the caller number may be shown on the Infotainment system display screen. If the number is stored in the system memory, the name is displayed instead. If the number cannot be displayed, the message **No Caller ID** is shown.

Functions during a telephone call

R15 BT USB, R16 BT USB, CD16 BT USB, CD18 BT USB - Functions during a telephone call

In addition to volume control, various functions are available during a call, including:

- switch the call to the mobile phone
- access the keyboard
- end call

Turn and press **OK** to select and confirm.

Switch the call from the handsfree phone system to the mobile phone by selecting the mobile phone display item. Some mobile phones may

become disconnected from the handsfree phone system during the switch to this mode.

A number can also be entered on the numerical keyboard (↵ 122) e.g. to control a voice server such as the voicemail box. Select the **#123** display item to access the numerical keyboard. Refer to "**Voicemail box**" for further information.

To end the call, depending on vehicle configuration:

- briefly press 
- press **TEL**
- select the  icon in the display

CD35 BT USB - Functions during a telephone call

In addition to volume control, various functions are available during a call, including:

- **Pause / Resume**
- **Handset**
- **Keyboard**
- **Hang up**

To put the caller on hold, select **Pause**; the caller is informed they are on hold via an automatic message. Select **Resume** to resume the call.

Switch the call from the handsfree phone system to the mobile phone by selecting **Handset**. Some mobile phones may become disconnected from the handsfree phone system during the switch to this mode.







A number can also be entered on the numerical keyboard (↵ 122) e.g. to control a voice server such as the voicemail box. Select the **Keyboard** menu item to access the numerical keyboard. Refer to "**Voicemail box**" for further information.

To end the call:

- press , or
- select **Hang up**, then press the central rotary knob

NAVI 50 - Functions during a telephone call

In addition to volume control, various functions are available during a call, including:

- : End call
- : Switch vehicle microphone off
- : Switch vehicle microphone on
- : transfer conversation to mobile phone
- : transfer conversation to vehicle's microphone and loudspeakers
- : Return to previous screen (e.g. Navigation or Home page)

NAVI 80 - Functions during a telephone call

In addition to volume control, various functions are available during a call, including:

- Place call on hold: Press **+** (to open pop-up menu) then select **On hold**. Press **Continue** to resume the call.

- Transfer conversation to mobile phone: Press **+** (to open pop-up menu) then select **Handset**.
In some cases, the phone may be disconnect from the Infotainment system during a call transfer.
- End call: Press **End call**.
- Return to previous menu: Press **←**.

Phone settings

CD35 BT USB - Phone settings

Press **SETUP / TEXT** and select the **Phone settings** menu.

Activate/deactivate automatic call waiting

To activate or deactivate automatic call waiting, access the **Put on hold** menu, then select either **Automatic** (the default setting) or **Manual**.

During automatic mode, a tone will sound to indicate that a call is on hold.

Change ringtones

The vehicle ringtone or phone ringtone can be changed for incoming calls. Access the **Ring tone** menu, then select **Vehicle** or **Phone**.

Note

Depending on phone model, the ringtone transfer function may not be available.

Restore default phone settings



To restore phone settings to their default values, select **Default settings** by turning and pressing the rotary knob. Confirm modification with the display option when prompted.

Display software version

To display the software version, select **Display software version** by turning and pressing the rotary knob.

NAVI 50 - Phone settings



Restore default phone settings

To access the settings menu at any time, press  followed by  **SETTINGS** on the display screen.

Select **System** followed by **Factory settings** then **Phone** to restore phone settings to their default values.

Confirm by pressing **OK**.

Display software version

To access the settings menu at any time, press  followed by  **SETTINGS** on the display screen.

Select **System** followed by **System version** to display the software version.

NAVI 80 - Phone settings

From the Home page, press **MENU** then **Phone** followed by **Settings** on the display screen.

Select from the following options on the display:

- **Manage devices:**

Refer to (NAVI 80) "Pairing a mobile phone" in the "Bluetooth connection" section ↷ 127.

- **Sound levels:**

To set the handsfree phone system call volume and the ringtone.

- **Voice mail:**

Refer to (NAVI 80) "Voicemail box" above.

- **Turn Bluetooth on/off:**

Refer to (NAVI 80) "Activating Bluetooth" in the "Bluetooth connection" section ↷ 127.

- **Automatically download phone data:**

Press this option to tick the box alongside it.

When pairing and/or connecting the mobile phone to the Infotainment system, the contact list and call lists in the mobile phone can now be downloaded to the handsfree phone system.

Data sharing must also be authorised on your phone. Refer to the operating instructions for your mobile phone or consult your network provider.

Mobile phones and CB radio equipment

Installation instructions and operating guidelines

The vehicle specific installation instructions and the operating guidelines of the mobile phone and handsfree manufacturer must be observed when installing and operating a mobile telephone. Failure to do so could invalidate the vehicle type approval (EU directive 95/54/EC).

Recommendations for fault-free operation:

- professionally installed exterior antenna to obtain the maximum range possible
- maximum transmission power 10 watts
- installation of the phone in a suitable spot, consider relevant Note in the Owner's Manual section **Airbag system**

Seek advice on predetermined installation points for the external antenna or equipment holder and ways of using devices with a transmission power exceeding 10 watts.

Use of a handsfree attachment without external antenna with mobile telephone standards GSM 900/1800/1900 and UMTS is only permitted if the maximum transmission power of the mobile telephone is 2 watts for GSM 900 or 1 watt for the other types.

For reasons of safety, do not use the phone while driving. Even use of a handsfree set can be a distraction while driving.

⚠ Warning

Operation of radio equipment and mobile telephones which fail to meet above mentioned mobile telephone standards is only permitted using an antenna located outside of the vehicle.

Caution

Mobile telephones and radio equipment may lead to malfunctions in the vehicle electronics when operated inside the vehicle with no exterior antenna, unless the above mentioned regulations are observed.

Index

A

AAC files.....	55
ACC files.....	61
Activating Bluetooth function.....	127
Activating the navigation system..	78
Activating voice recognition.....	120
Adaptation volume km/h.....	39
Add a favourite destination.....	97
Adding contacts to the phonebook.....	131
AF (Alternative Frequency).....	51
AGC Activated.....	36
Aha® application.....	24
Applications.....	24
AST (Autostore list).....	50
Audio CDs.....	55
Audio players.....	24
Audio settings.....	36, 56
Automatic call waiting.....	131
Automatic Gain Control (AGC).....	36
Automatic phone connection.....	124
Automatic station search.....	47
Automatic station storing.....	50
Automatic switch-off.....	24
Automatic zoom.....	78
Autostore lists.....	50
AUX input.....	59
AUX input usage.....	59
Avoid part of route.....	106
Avoid roadblocks.....	106

B

Balance.....	36
Bass.....	36
Battery replacement.....	78
Bluetooth.....	122
Bluetooth connection.....	65, 127
Bluetooth device list.....	127
Bluetooth music.....	65
Browse map.....	106

C

Calculate alternative route.....	106
Call lists.....	131
Call waiting.....	131
CD display.....	56
CD playback.....	56
CD player.....	55, 56
CD-Text.....	56
Change Home location.....	78
Change passkey for Bluetooth connection.....	127
Change system language.....	24, 40
Clock.....	24, 40, 78
Compass.....	78
Connecting an audio device.....	65
Connection.....	124
Control elements overview.....	6
Co-ordinates.....	78, 97
Country information.....	106, 131

- D**
- DAB..... 54
 - Deactivating Bluetooth function.. 127
 - Deactivating guidance..... 106
 - Defining the priority phone..... 124
 - Delete a favourite destination..... 97
 - Delete device from Bluetooth
 - device list..... 127
 - Destination..... 78
 - Destination input 97
 - Dialling a telephone number..... 131
 - Digital audio broadcasting..... 54
 - Disable camera warnings..... 106
 - Disconnecting an audio device.... 65
 - Disconnecting a phone..... 124
 - Display..... 24
 - Display information..... 56
 - Displaying pictures..... 72
 - Display screen operation..... 24, 122
 - Driving Eco2..... 24
 - Driving economy..... 24
- E**
- Eco coaching..... 24
 - Edit Itinerary..... 106
 - Emergency call..... 131
 - Emergency number..... 131
 - Emergency phone numbers..... 106
 - Enter an address..... 97
- Entering a number manually..... 131
- External device authorisation..... 127
- F**
- Fader..... 36
 - Fast forward..... 56
 - Fast rewind..... 56
 - Favourite destinations..... 97
 - Favourites..... 24
 - Media..... 24
 - Navigation..... 24
 - Phone..... 24
 - Services..... 24
 - Find on map..... 106
 - FM station list..... 50
 - Functions during a telephone call 131
- G**
- General information... 4, 55, 59, 61, 65, 74, 118, 122
 - GPS (Global Positioning System). 74
 - Guidance 106
 - Guided tours..... 78
- H**
- Handsfree phone system..... 131
 - HD Traffic..... 78
 - Help!..... 106, 118
 - Home address..... 97
 - Home location..... 78
- I**
- ID3 tags..... 56
 - Image settings..... 24
 - Image viewer..... 78
 - I News service..... 51
 - Information on the display..... 78
 - Infotainment controls..... 24
 - Infotainment system
 - Switching on/off..... 24
 - Instrument panel controls..... 6
 - Intersection view..... 78
 - Ioniser..... 24
 - iPod..... 61, 62
 - I-Traffic service..... 51
- J**
- Jack plug..... 59
- K**
- Keyboards in the display..... 78, 122
- L**
- Lane images..... 78
 - Language..... 24
 - Latitude, Longitude..... 97
 - Live services..... 78
 - Local search..... 97
 - Loudness..... 36
 - Low volume sound enhancement. 36

M

Mailbox.....	131
Manual phone connection.....	124
Manual station search.....	47
Manual station storing.....	50
Maps.....	74
Map screen.....	78
Menu screen.....	78
Minimise traffic delays.....	106
MIX.....	56
Mobile phones and CB radio equipment	140
Modes of operation.....	24
Motorway view.....	78
MP3 CDs.....	55
MP3 files.....	61
MP3 player.....	62
MP3 players.....	61
Multimedia.....	72
Multimedia settings.....	40
Musical atmosphere.....	36
Mute.....	24, 56
My TomTom LIVE.....	78

N

Navigation control.....	120
Navigation services.....	24

Navigation system

Creating a TOMTOM HOME™ account.....	74
Creating an account.....	74
GPS (Global Positioning System).....	74
Installing the software.....	74
Maps.....	74
Registering the Navigation system.....	74
SD card.....	74
Software installation.....	74
TomTom HOME™.....	74
Traffic info service.....	74
USB memory stick.....	74
Navigation system preferences....	78
Navigation volume.....	78
Navigation warnings.....	78
News.....	51

O

On-board computer.....	24
Operation.....	65, 131
Outside air quality.....	24

P

Pairing a mobile phone.....	127
Pairing an audio device.....	65
Park Assist.....	24
Pause.....	56
Phone.....	122

Phonebook.....	131
Phone connection.....	124
Phone control.....	120
Phone controls.....	122
Phone installation instructions....	140
Phone menu.....	131
Phone operating guidelines.....	140
Phone settings.....	131
Photos.....	72
Pictures.....	72
Planning preferences.....	78
Playing movies.....	72
Playing music via Bluetooth.....	65
Playing saved audio files.....	62
POI categories.....	97
Points of interest.....	24
Points of Interest (POI).....	97
POIs.....	24, 97
Portable CD players.....	59
Prepare route in advance.....	97
PTY (Program type).....	51

Q

Quick menu.....	78
-----------------	----

R

Radio.....	45
DAB.....	54
Digital Audio Broadcasting.....	54
Radio controls.....	45
Radio data system (RDS)	51

Radio functions.....	50, 51
Radio reception.....	45
Radio station name search.....	47
Radio text.....	51
Random playback.....	56
RDS.....	51
Rear camera.....	24
Rear camera view settings.....	24
Rear OFF.....	36
Recalling a station.....	50
Recalling a stored station.....	47
Receiving calls.....	131
Recent destinations.....	97
Region.....	51
Remote control.....	78
Remote engine start-up.....	24
Removing a CD.....	56
Report safety camera.....	106
Restore default settings.....	24
Restore factory settings.....	40
Route.....	78
Route information.....	106
Route overview.....	106
Route planning method.....	78
Route settings.....	78
S	
Safety alerts.....	78
Save a favourite destination.....	97
Saved locations.....	97

Scent diffuser.....	24
SD card.....	74, 78
Search for Bluetooth device.....	127
Search radio station name.....	47
Security code.....	23
Select a destination.....	97
Selecting an album.....	56
Selecting a track.....	56
Selecting the waveband.....	45
Services.....	24
Settings.....	24
Setting the time.....	24
Setting the volume.....	24
Setting up the navigation system.....	78
Show route summary.....	106
Show traffic on route.....	106
Slideshow.....	78
Software version.....	131
Sound optimisation.....	36
Speed cameras.....	78
Speed dependent volume.....	39
Station search.....	47
Station storing.....	50
Steering column controls.....	6
Store.....	24
Stored stations.....	47
Switching on/off.....	24
Symbols overview.....	117
System settings.....	40

T

Text information (CD-Text or ID3 tag).....	56
Text information (Radio text).....	51
Theft-deterrent feature.....	23
Thumbnails.....	72
Time.....	24
TomTom HOME™.....	74
TomTom safety cameras.....	106
Tone settings.....	36
Traffic announcements (TA).....	51
Traffic announcement volume.....	39
Traffic information.....	106
Traffic info service.....	74
Traffic safety.....	4, 122
Treble.....	36
Trip computer.....	24
Trip report.....	24

U

Unpairing a mobile phone.....	127
Update FM list.....	50
Updating stations list.....	50
Usage.....	24, 45, 56, 59, 78
USB drive.....	61
USB drives.....	62
USB memory stick.....	74, 78
USB port.....	61
USB socket.....	62
Using the CD player.....	56

Using the display screen.....	24
Using the Infotainment system.....	24
Using this manual.....	4

V

Vehicle information.....	24
Videos.....	72
View route.....	106
Voice control.....	120
Voicemail box.....	131
Voice preferences.....	78
Voice recognition.....	118, 120
Voice tags.....	120
Volume.....	120
Adaptation volume km/h.....	39
Automatic Gain Control (AGC)..	36
Low volume sound enhancement.....	36
Rear OFF.....	36
Speed dependent volume... ..	24, 39
Traffic announcement volume... ..	39
Volume distribution.....	36
Volume control.....	131
Volume settings.....	39

W

Waveband selection.....	45
WAV files.....	55
Waypoints.....	97, 106
Weather.....	78
Where am I?.....	106, 131

WMA CDs.....	55
WMA files.....	61

www.opel.com

Copyright by ADAM OPEL AG, Rüsselsheim, Germany.

The information contained in this publication is effective as of the date indicated below. Adam Opel AG reserves the right to make changes to the technical specifications, features and design of the vehicles relative to the information in this publication as well as changes to the publication itself.

Edition: April 2015, ADAM OPEL AG, Rüsselsheim.

Printed on chlorine-free bleached paper.

KTA-2701/7-en

04/2015

