

# OPEL ZAFIRA TOURER

Infotainment Manual





---

# Contents

Navi 950/650 / CD 600 .....	5
CD 400plus (1)/400/300 .....	81
CD 400plus (2) .....	133



---

## Navi 950/650 / CD 600

Introduction .....	6
Basic operation .....	16
Radio .....	24
CD Player .....	30
External devices .....	32
Navigation .....	37
Speech recognition .....	55
Phone .....	64
Frequently asked questions .....	72
Index .....	76

## Introduction

General information .....	6
Theft-deterrent feature .....	7
Control elements overview .....	8
Usage .....	14

## General information

The Infotainment system provides you with state-of-the-art in-car infotainment.

The radio can easily be used by registering a large number of FM, AM and DAB (Digital Audio Broadcasting) radio stations with the 1...6 preset buttons.

You can connect external data storage devices, e.g. iPod, USB devices, or other auxiliary devices to the Infotainment system as further audio sources; either via cable or via Bluetooth.

The navigation system reliably guides you to your destination and, if desired, automatically avoids traffic jams or other traffic problems.

In addition, the Infotainment system is equipped with a phone application that allows for comfortable and safe use of your mobile phone in the vehicle.

Optionally, the Infotainment system can be operated using the instrument panel controls, the controls on the steering wheel or the speech recognition function.

The well-thought-out design of the control elements and the clear displays enable you to control the system easily and intuitively.

Information on operation details and news on software updates can be obtained on our website.

### Note

This manual describes all options and features available for the various Infotainment systems. Certain descriptions, including those for display and menu functions, may not apply to your vehicle due to model variant, country specifications, special equipment or accessories.

## Important information on operation and traffic safety

### Warning

The Infotainment system must be used so that the vehicle can be driven safely at all times. If in doubt, stop the vehicle and operate the Infotainment system while the vehicle is stationary.

### Warning

The usage of the navigation system does not release the driver from the responsibility for a correct, vigilant attitude in road traffic. The related traffic regulations must always be followed.

Only make entries (e.g. addresses) with the vehicle stationary.

If a navigation instruction contradicts traffic regulations, the traffic regulations always apply.

### Warning

Areas such as one-way streets and pedestrian zones are not marked on the navigation system map. In such areas, the system may issue a warning that must be accepted. Therefore, pay particular attention to one-way streets and other roads and entrances that must not be driven into.

### Radio reception

Radio reception may be disrupted by static, noise, distortion or loss of reception due to:

- changes in distance from the transmitter
- multi-path reception due to reflection
- shadowing

### Theft-deterrent feature

The Infotainment system is equipped with an electronic security system for the purpose of theft deterrence.









The Infotainment system therefore functions only in your vehicle and is worthless to a thief.

## Control elements overview

Navi 950 / 650





- |   |  |  |
|---|--|--|
| <p><b>1</b>  Access Home Page ..... 16</p> <p><b>2</b> Station buttons 1...6</p> <p>Short press: select station .... 26</p> <p>Long press: save station ..... 26</p> <p><b>3</b> <b>DEST / NAV</b></p> <p>Open navigation destination menu ..... 42</p> <p><b>4</b>  </p> <p>Radio: search backwards ..... 24</p> <p>CD/MP3/WMA: skip track backwards ..... 31</p> <p>External devices: skip track backwards ..... 34</p> <p><b>5</b>  <b>VOL</b></p> <p>Press: switch on/off Infotainment system ..... 14</p> <p>Turn: adjust volume ..... 14</p> <p><b>6</b>  </p> <p>Radio: search forwards ..... 24</p> | <p>CD/MP3/WMA: skip track forwards ..... 31</p> <p>External devices: skip track forwards ..... 34</p> <p><b>7</b>  <b>II</b></p> <p>CD/MP3/WMA: start/pause playback ..... 31</p> <p>External devices: start/pause playback ..... 34</p> <p><b>8</b> <b>FAV 1-2-3</b></p> <p>Open favourites list ..... 26</p> <p><b>9</b> <b>AS 1-2</b></p> <p>Short press: open autostore list ..... 25</p> <p>Long press: save autostore stations automatically ..... 25</p> <p><b>10</b> <b>TP</b></p> <p>Activate or deactivate radio traffic service ..... 27</p> <p><b>11</b> </p> <p>Eject CD ..... 31</p> | <p><b>12</b> <b>CONFIG</b></p> <p>Open settings menu ..... 21</p> <p><b>13</b> <b>INFO</b></p> <p>Radio: information on current station</p> <p>CD/MP3/WMA, external devices: information on current track</p> <p>Navigation: information, e.g. on current location</p> <p><b>14</b> Multifunction knob</p> <p>Turn: mark menu options or set alphanumeric values .. 16</p> <p>Press (the outer ring): select/activate the marked option; confirm set value; switch function on/off; open audio or navigation menu ..... 16</p> <p><b>15</b> Eight-way switch</p> <p>Navigation: move display window in map view ..... 38</p> |
|---|--|--|

**16 BACK**

Menu: one level back ..... 16

Input: delete last character  
or entire entry ..... 16

**17 RPT / NAV**

Repeat last navigation  
message ..... 50

**18 CD slot** ..... 31

**19 **

Take phone call or  
activate/deactivate mute ..... 67

**20 NAV**

Display map ..... 38

**21 SRCE (Source)**

Press to toggle through the  
different audio sources

CD/MP3 player ..... 30

USB ..... 32

AUX ..... 32







Bluetooth ..... 32

AM ..... 24

FM ..... 24

DAB ..... 24





<p><b>1</b>  Access Home Page ..... 16</p> <p><b>2</b> Station buttons 1...6</p> <p>Long press: save station ..... 26</p> <p>Short press: select station .... 26</p> <p><b>3</b>  <b>Radio:</b> search backwards ..... 24</p> <p>CD/MP3/WMA: skip track backwards ..... 31</p> <p>External devices: skip track backwards ..... 34</p> <p><b>4</b>  <b>VOL</b></p> <p>Press: switch on/off Infotainment system ..... 14</p> <p>Turn: adjust volume ..... 14</p> <p><b>5</b>  <b>Radio:</b> search forwards ..... 24</p> <p>CD/MP3/WMA: skip track forwards ..... 31</p> <p>External devices: skip track forwards ..... 34</p>	<p><b>6 FAV 1-2-3</b></p> <p>Open favourites list ..... 26</p> <p><b>7 AS 1-2</b></p> <p>Short press: open autostore list ..... 25</p> <p>Long press: save autostore stations automatically ..... 25</p> <p><b>8 TP</b></p> <p>Activate or deactivate radio traffic service ..... 27</p> <p><b>9</b>  Eject CD ..... 31</p> <p><b>10 CONFIG</b></p> <p>Open settings menu ..... 21</p> <p><b>11 INFO</b></p> <p>Radio: information on current station</p> <p>CD/MP3/WMA, external devices: information on current track</p>	<p><b>12 Multifunction knob</b></p> <p>Turn: mark menu options or set alphanumeric values .. 16</p> <p>Press: select/activate the marked option; confirm set value; switch function on/off; open audio menu ..... 16</p> <p><b>13 BACK</b></p> <p>Menu: one level back ..... 16</p> <p>Input: delete last character or entire entry ..... 16</p> <p><b>14 Tone</b></p> <p>Open tone settings ..... 19</p> <p><b>15 CD slot</b> ..... 31</p> <p><b>16</b>  Take phone call or activate/deactivate mute ..... 67</p> <p><b>17</b>  CD/MP3/WMA: start/pause playback ..... 31</p> <p>External devices: start/pause playback ..... 34</p>
--	--	---

**18 SRCE (Source)**

Press to toggle through the different audio sources

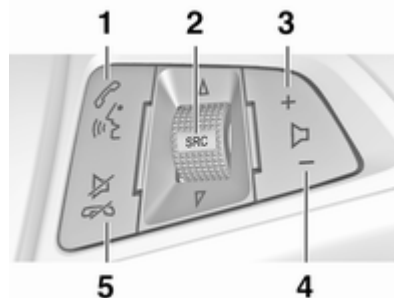
CD/MP3 player .....	30
USB .....	32
AUX .....	32
Bluetooth .....	32
AM .....	24
FM .....	24
DAB .....	24

**Steering wheel audio controls**

- 1**  **1**
- Short press: take phone call . 67  
or dial number in call list ..... 67  
or activate speech  
recognition ..... 55
- Long press: show call list ..... 67  
or activate voice pass-thru  
(if supported by phone) ..... 55
- 2** **SRC (Source)**  
Press: select audio source .... 24

- With radio active: turn up/  
down to select next/  
previous preset radio  
station ..... 24
- With CD player active: turn  
up/down to select next/  
previous CD/MP3/WMA  
track ..... 31
- With external device  
active: turn up/down to  
select next/previous track .... 34
- With phone active: turn up/  
down to select next/  
previous entry in call list ..... 67
- With phone active and  
calls waiting: turn up/down  
to switch between calls ..... 67
- 3** **+**  
Increase volume ..... 14
- 4** **-**  
Reduce volume ..... 14
- 5**  **5**  
Short press: end/decline  
call ..... 67

or close call list .....	67
or activate/deactivate mute ...	14
or deactivate speech recognition .....	55

## Usage

### Control elements

The Infotainment system is operated via function buttons, a multifunction knob and menus that are shown on the display.

Inputs are made optionally via:

- the central control unit on the instrument panel ↷ 8
- controls on the steering wheel ↷ 8
- the speech recognition system ↷ 55

#### Note

Only the most direct ways for menu operation are described in the subsequent chapters. In some cases, there may be other options.

### Switching the Infotainment system on or off

Press  $\odot$  briefly. After switching on, the last selected Infotainment source becomes active.

### Automatic switch-off

If the Infotainment system is switched on pressing  $\odot$  while the ignition is switched off, it switches off again automatically after 10 minutes.

### Setting the volume

Turn  $\odot$ . The current setting is shown in a pop-up at the bottom of the screen.

When the Infotainment system is switched on, the last selected volume is set, provided that the volume is lower than the maximum start-up volume.

The following volume settings can be set separately:



- the maximum start-up volume ↷ 20
- the volume of the traffic announcements ↷ 20
- the volume of the navigation messages ↷ 38

### Auto volume

When auto volume is activated ↗ 20, the volume is adapted automatically to compensate for the road and wind noise as you drive.

### Mute

Press  (if Phone portal is available: press for a few seconds) to mute the audio sources.

To cancel mute again: turn  VOL or press the  again (if Phone portal is available: press for a few seconds).

### Volume limitation at high temperatures

At very high temperatures inside the vehicle, the Infotainment system limits the maximum adjustable volume. If necessary, the volume is decreased automatically.

### Modes of operation

#### Audio players

Repeatedly press **SRCE** to toggle between the AM, FM, CD, USB, AUX, Bluetooth or DAB main menus.

For detailed descriptions of:

- CD/MP3 player ↗ 30
- USB port ↗ 32
- AUX input ↗ 32
- Bluetooth audio ↗ 32
- AM radio ↗ 24
- FM radio ↗ 24
- DAB radio ↗ 28

#### Navigation

Press **NAV** to display the map of the navigation application.

Press the multifunction knob to open a submenu with options for the input of destinations and the structuring of a route.

For a detailed description of the navigation functions ↗ 37.

#### Phone

Press  to display the phone main menu with options for the input or selection of numbers.

For a detailed description of the mobile phone functions ↗ 64.

### Note

Brief information on the audio sources and the current navigation session may be displayed via the **Quick Info** application.

## Basic operation

Basic operation .....	16
Tone settings .....	19
Volume settings .....	20
System settings .....	21

## Basic operation

### Multifunction knob

The multifunction knob is the central control element for the menus.

Turn the multifunction knob:

- to mark a menu option
- to set an alphanumeric value

Press the multifunction knob (Navi 950 / Navi 650: press the outer ring):

- to select or activate the marked option
- to confirm a set value
- to switch a system function on/off
- to open the audio or navigation menu within the respective application

### Home button

Press  to access the **Home Page**.



Using the multifunction knob, you may then access the different applications.

Turn the multifunction knob to select **More** at the bottom of the screen.





Press the multifunction knob (Navi 950 / Navi 650: press the outer ring) to display the second **Home Page** with further applications.

Using the multifunction knob, you may then access the different applications.

#### Note

Most of the applications or application menus may also be directly accessed via the buttons on the instrument panel.

## BACK button

Press **BACK**:

- to exit a menu or screen
- to return from a submenu to the next higher menu level
- to delete the last character in a character sequence

Press and hold **BACK** for a few seconds to delete the entire entry.

## Examples of menu operation

### Selecting a screen element

Turn the multifunction knob to move the cursor (= coloured background) to the desired option.

Press the multifunction knob to select the marked icon, screen button or menu item.

#### Note

In subsequent chapters the operating steps for selecting and activating a screen button or menu item will be described as "...select <button name>/<item name>".

## Scrolling lists



If there are more menu items available in a list than presentable on the screen, a scrollbar is displayed.

Turn the multifunction button clockwise to scroll downwards and anticlockwise to scroll upwards.

#### Note

In subsequent chapters the operating steps for scrolling to a list item will be described as "...scroll to <item name>".

### Adjusting a setting

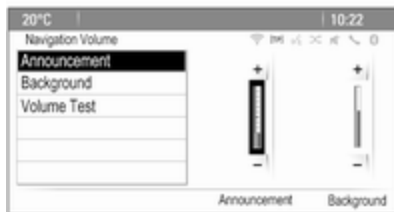

Turn the multifunction knob to change the current value of the setting.

Press the multifunction knob to confirm the set value.

#### Note

In subsequent chapters the operating steps for adjusting a setting will be described as "...adjust <setting name> to...".

### Activating a menu item

Turn the multifunction knob to move the cursor (= coloured background) to the desired option.

Press the multifunction knob to activate the menu item. A checkmark or a point appear within the box or ring beside the respective menu item.



#### Note

In subsequent chapters the operating steps for activating a menu item will be described as "...activate <item name>".

### Entering a character sequence

Turn the multifunction knob to select the desired character.

Press the multifunction knob to enter the respective character in the entry field at the top of the screen.

The last character in the character sequence can be deleted by pressing **Del** on the screen or **BACK** on the instrument panel. Pressing and holding **BACK** deletes the entire entry.

Press the multifunction knob to confirm the selected character.

#### Note

In subsequent chapters the operating steps for entering characters will be described "...enter the desired characters...".

### Messages

Before a system function is executed, you are sometimes prompted with a message. If requested, select one of the options.



The selection and activation of a screen button in a message function are the same as described for selecting an option in a menu.

## Tone settings

Press  and then select **More** at the bottom of the screen. On the second **Home Page**, select **Tone**. The tone settings menu is displayed.



### Bass

Use this setting to enhance or attenuate the deep frequencies of the audio sources.

Adjust the setting as desired.

### Mid

Use this setting to enhance or attenuate the midrange frequencies of the audio source.

Adjust the setting as desired.

### Treble

Use this setting to enhance or attenuate the high frequencies of the audio sources.

Adjust the setting as desired.

## EQ mode

(EQ: Equaliser)

Use this setting to optimise the tone for a specific style of music, e.g.

**Rock** or **Classical**.

Select **EQ**. A submenu with predefined sound styles is displayed. Select the desired sound style.

If one of the predefined sound styles is selected, **Bass**, **Mid** and **Treble** are preadjusted by the system.

If you manually adjust one of the settings described above, **EQ** is set to **Manual**.

## Fade and Balance

When **Fade** or **Balance** are selected, an illustration is displayed on the right side of the screen.



To adjust the volume distribution between the front and rear speakers in the vehicle, select **Fade**. Adjust the setting as desired.

To adjust the volume distribution between the left and right speakers in the vehicle, select **Balance**. Adjust the setting as desired.

## Volume settings

### Adjusting the Auto Volume

Press **CONFIG** and then select **Radio Settings**.

Select **Auto Volume** to display the respective menu.

To adjust the degree of volume adaptation, set **Auto Volume** to **Off**, **Low**, **Medium** or **High**.

**Off**: no enhancement of volume with increasing vehicle speed.

**High**: maximum enhancement of volume with increasing vehicle speed.

### Adjusting the Startup Volume

Press **CONFIG** and then select **Radio Settings**.

Select **Startup Volume** to display the respective menu.

Adjust the setting as desired.

### Adjusting the volume of traffic announcements

The volume of traffic announcements can be preset to a level independent of the "normal" volume level.

Press **CONFIG** and then select **Radio Settings**.

Select **RDS Options** and then **Traffic Volume** to display the respective menu.

Adjust the setting as desired.

#### Note

While an announcement is given out, the volume may simply be adjusted pressing  $\odot$ .

### Adjusting the Chime Volume

When operating the controls in the vehicle, beeping sounds confirm your actions. The volume of the beeping sounds may be adjusted.

Press **CONFIG** and then select **Vehicle Settings**.

Select **Comfort and Convenience** and then **Chime Volume** to display the respective submenu. Select **Low** or **High**.

### Adjusting the Navigation Volume

Press **CONFIG** and then select **Navigation Settings**.

Select **Voice Prompt** and then **Navigation Volume**. The respective submenu is displayed.

To adjust the volume of the announcements, select **Announcement** and then adjust the setting as desired.

To adjust the volume of the audio source possibly playing in the background, select **Background** and then adjust the setting as desired.

Select **Volume Test** to get an audio example of the settings.

#### Note

While an announcement is given out, the volume may simply be adjusted pressing  $\odot$ .

## System settings

Various Infotainment system settings may be adjusted via the **Config** application.



### Language settings

Press **CONFIG** and then select **Languages**. A list of all languages available is displayed.

Select the desired language.

### Time and date settings

Press **CONFIG** and then select **Time and Date** to display the respective submenu.

### Automatic time adjustment

The system constantly receives information on the current time and date.

If you wish the time and date settings to be updated automatically, activate **RDS Auto Time Adjust**.

If you wish to set time and date manually, deactivate **RDS Auto Time Adjust**.

### Set time

To adjust the time settings, select **Set Time**.

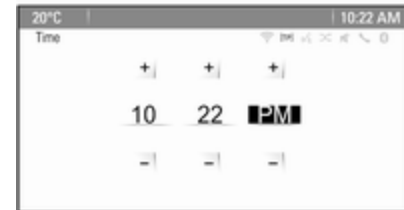

Adjust the settings as desired.

### Set date

To adjust the date settings, select **Set Date**. Adjust the settings as desired.

### Time format

To choose the desired time format, select **12 hr / 24 hr Format**. A submenu is displayed. Activate **12 Hour** or **24 Hour**.

### Software information

Press **CONFIG** and then select the **Radio Settings**.

Scroll through the list and select **Software Versions Menu** to display the respective submenu.

### Software version information

To display a list of all software versions installed, select **Software Version Information**.

By default, all versions are activated.

### Software update

To update your system software, contact your Opel Service Partner.

### Log file

To generate a log file of your current software version, select **Create Log File**.

### Licensing information

To display information on the manufacturer of the Infotainment system, select **Licensing Information**.

### Factory defaults

To reset all Infotainment settings to their factory defaults, select **Clear and Reset Radio**.

### Display settings

Press **CONFIG** and then select **Display Settings** to display the respective submenu.

### Home Page

Select **Home Page Menu** to display the home page settings menu.

To access the menu from the **Home Page**, select **Menu** at the bottom of the screen.

The **Home Page** may be adjusted according to your personal preferences.

### Customise

The application icons displayed on the first home page may be chosen as desired.

Select **Customise** to display a list of all applications installed in the system. Activate the menu items of those applications you wish to be displayed on the first home page.

The other applications are then arranged on the following pages.

### Sort

Up to eight application icons may be arranged on each home page.

The positions of the icons can be changed as desired.

Select **Sort** to display the home pages in edit mode.

Select the icon you wish to move.

Scroll to the position on the home page where you wish the icon to be located. Press the multifunction knob to confirm.

The icon is moved to the new location. The icon that was located in that position before is now displayed in the position of the moved icon.

### Home page defaults

To reset the **Home Page** to its factory defaults, select **Restore Home Page Defaults**.

**Display Off**

To turn the display off, select **Display Off**.

To turn the display back on, press any button on the instrument panel (except the  $\odot$  **VOL** knob).

## Radio

Usage .....	24
Station search .....	24
Autostore lists .....	25
Favourite lists .....	26
Radio data system (RDS) .....	27
Digital audio broadcasting .....	28

## Usage

### Activating radio

Press  and then select **AM**, **FM** or **DAB**.

The station last selected is played.

#### Note

When an audio source is already active, you may toggle between the different audio sources by repeatedly pressing **SRCE**.

## Station search

### Automatic station search

Briefly press **◀◀** or **▶▶** to play the next station in the station memory.

### Manual station search

Press and hold **◀◀** or **▶▶**. Release the button when the required frequency has almost been reached on the frequency display.

### Manual station tuning

In the FM and DAB waveband, press the multifunction knob to open the respective menu and then select

**Manual tuning.** The frequency currently active is displayed at the bottom of the screen.

Turn the multifunction knob to reach the desired frequency.

In the AM waveband, turn the multifunction knob to adjust the frequency.

### Station lists

In the FM and DAB waveband, turn the multifunction knob to display the station list.

In the AM waveband, press the multifunction knob to display the respective waveband menu.

Select **AM Station List**.

A list of all receivable stations of the relevant waveband and in the current reception area is displayed.

#### Note

If no station list has been created beforehand, the Infotainment system performs an automatic station search.



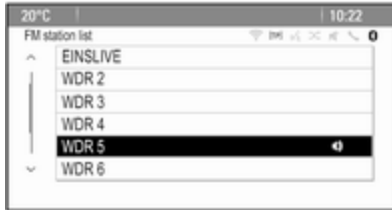



Select the desired station.

#### Note

The currently received station is marked by .

### Category list

Numerous RDS  27 and DAB  28 stations broadcast a PTY code, which specifies the type of programme transmitted (e.g. news). Some stations also change the PTY code depending on the content which is currently transmitted.

The Infotainment system stores these stations in the corresponding category list sorted by programme type.

#### Note

The category list submenu item is only available for the FM and the DAB wavebands.

To search for a programme type determined by the stations, select the waveband specific category list option.

A list of programme types currently available is displayed.

Select the desired programme type. A list of stations is displayed transmitting a programme of the selected type.

Select the desired station.

#### Note

The currently received station is marked by .

### Updating the station lists

If the stations stored in the waveband-specific station list can no longer be received, the AM and the DAB station lists must be updated.

#### Note

The FM station list is updated automatically.

Select the corresponding list item in the waveband-specific menu to update a station list.

A station search is started. Once the search is finished, the station previously selected is played.

To cancel the station search, press the multifunction knob.

#### Note

If a waveband-specific station list is updated, the corresponding category list is also updated.

### Autostore lists

The stations best received in a waveband can be stored in and selected from the autostore lists.



Each waveband has 2 autostore lists (**AS 1**, **AS 2**), in each of which 6 stations can be stored.

#### Note

The currently received station is highlighted.

### Automatic station storing

Keep **AS** pressed until an autostore message is displayed. The 12 strongest stations in the current waveband are stored in the two autostore lists.

To cancel the autostore procedure, select **Cancel**.

### Storing stations manually

Stations can also be stored manually in the autostore lists.

Set the station to be stored.

Press **AS** to open the autostore list or to switch to another autostore list.

To store the station in a list position: press the corresponding station button 1...6 until a confirmation message is displayed.

#### Note

Manually stored stations are overwritten in an automatic station storing process.

### Retrieving a station

If required, press **AS** to open an autostore list or to switch to another autostore list.

Press one of the station buttons 1...6 to activate the station at the corresponding list position.

### Favourite lists

Stations of all wavebands can be stored manually in the favourite lists.



6 stations can be stored in each favourite list. The number of available favourite lists can be set (see below).

#### Note

The currently received station is highlighted.

### Storing a station

Set the station to be stored.

Briefly press **FAV** to open a favourite list or to switch to another favourite list.

To store the station in a list position: press the corresponding station button 1...6 until a confirmation message is displayed.

## Retrieving a station

If required, briefly press **FAV** to open a favourite list or to switch to another favourite list. Press one of the station buttons 1...6 to activate the station stored in the respective location.

## Defining the number of favourite lists

Press **CONFIG** and then select **Radio Settings**. Select **Number of Favourite Pages** to display the respective submenu.

Select the number of favourite pages you wish to be displayed.

## Radio data system (RDS)

RDS is a service of FM stations that considerably facilitates the finding of the desired station and its fault-free reception.

## Advantages of RDS

- On the display the programme name of the set station appears instead of its frequency.
- During station search the Infotainment system tunes in to RDS stations only.
- The Infotainment system always tunes in to the best receivable broadcasting frequency of the set station by means of AF (Alternative Frequency).
- Depending on the station that is received the Infotainment system displays radio text that can contain, for example, information on the current programme.

## RDS Options menu

To open the menu for the RDS configuration, press **CONFIG** and then select **Radio Settings**.

Select **RDS Options** to display the respective submenu.



## Activating the RDS function

Activate **RDS**.

### Note

If **RDS** is deactivated, not all menu items of the **RDS Options** menu are displayed.

## Regional

RDS stations sometimes broadcast regionally different programmes on different frequencies.

If **Regional** is activated, only alternative frequencies (AF) with the same regional programmes are selected.

If **Regional** is deactivated, alternative frequencies of the stations are selected without regard to regional programmes.

### Text Scroll Freeze

Some RDS stations do not only show the programme service name on the display, but also additional information on the current programme. If additional information is displayed, the programme name is hidden.

To prevent additional information from being displayed, activate **Text Scroll Freeze**.

### Radio Text

If RDS and the reception of an RDS station are activated, information on the radio programme currently active or the music track currently playing are displayed below the programme name.

To show or hide the information, activate or deactivate **Radio Text**.

### Radio traffic service

(TP = Traffic Programme)

Radio traffic service stations are RDS stations that broadcast traffic news.

If the radio traffic service is switched on, radio or media playback is interrupted for the duration of the traffic announcement.

### Switching the radio traffic service on and off

To switch the traffic announcement standby facility of the Infotainment system on and off, press **TP**.

- If the radio traffic service is switched on, [ ] is indicated on the display.
- If the current station is not a radio traffic service station, a search is started automatically for the next radio traffic service station.
- If a radio traffic service station has been found, [TP] is indicated on the display.

### Traffic Volume

To adjust the volume of traffic announcements, select **Traffic Volume**. The respective submenu is displayed. Adjust the setting as desired.

### Listening to traffic announcements only

Switch on the radio traffic service and completely turn down the volume of the Infotainment system.

### Blocking out traffic announcements

To block out a traffic announcement, e.g. during CD/MP3 playback:

Press **TP** or select **Cancel** in the TP message on the screen.

The traffic announcement is cancelled, but the radio traffic service remains switched on.

### Digital audio broadcasting

Digital audio broadcasting (DAB) is an innovative and universal broadcast system.

## General information

- DAB stations are indicated by the programme name instead of the broadcasting frequency.
- With DAB, several radio programmes (services) can be broadcasted on a single frequency (ensemble).
- Besides high-quality digital audio services, DAB is also able to transmit programme-associated data and a multitude of other data services including travel and traffic information.
- As long as a given DAB receiver can pick up the signal sent out by a broadcasting station (even if the signal is very weak), sound reproduction is ensured.
- There is no fading (weakening of the sound) that is typical of AM or FM reception. The DAB signal is reproduced at a constant volume.
- Interference caused by stations that are on nearby frequencies (a phenomenon that is typical of AM and FM reception) does not occur with DAB.

If the DAB signal is too weak to be picked up by the receiver, the system switches over to the same programme on another DAB or FM station.

- If the DAB signal is reflected by natural obstacles or buildings, the reception quality of DAB is improved, whereas AM or FM reception is considerably impaired in such cases.
- When DAB reception is enabled, the FM tuner of the Infotainment system remains active in the background and continually searches for the best receivable FM stations. If TP ⇨ 27 is activated, traffic announcements of the FM station which is currently best received are issued. Deactivate TP, if DAB reception should not be interrupted by FM traffic announcements.

## DAB announcements

Besides their music programmes, lots of DAB stations also broadcast announcements of various categories.

While being in the DAB main menu, press the multifunction knob to open the **DAB menu** and then select **Announcements**.

If you activate some or all categories, the currently received DAB service is interrupted when an announcement of these categories is made.

Activate the desired categories.

## CD Player

General information .....	30
Usage .....	31

### General information

#### Important information about audio CDs and MP3/WMA CDs

The Infotainment system's CD player can play audio CDs and MP3/WMA CDs.

#### Caution

Under no circumstances place DVDs, single-CDs with a diameter of 8 cm or shaped CDs in the audio player.

You must not put any stickers on CDs. These discs can get jammed in the CD drive and ruin the player. Replacement of the device will then be necessary.

### File formats

#### Audio CDs

The following CD formats can be used: CD-ROM Mode 1 and Mode 2; CD-ROM XA Mode 2, Form 1 and Form 2.

### MP3 CDs

The following file formats can be used: ISO9660 Level 1, Level 2, (Romeo, Joliet).

MP3 and WMA files written in any format other than listed above may not play correctly, and their file names and folder names may not be displayed correctly.

The following restrictions apply for the data stored on an MP3/WMA CD:

Number of tracks: max. 999.

Number of folders: max. 255.

Folder structure depth:  
max. 64 levels (recommended:  
max. 8 levels).

Number of playlists: max. 15.

Number of songs per playlist:  
max. 255.

Applicable playlist  
extensions: .m3u, .pls, .asx, .wpl.

## Usage

### Starting CD playback

Push the CD with the labelled side facing upwards into the CD slot until it is pulled in.

CD playback starts automatically and the **CD** or **MP3 CD** main menu is displayed.

If there is already a CD inserted, but the **CD** or **MP3 CD** main menu is not active, press  and then select **CD**.

The **CD** or **MP3 CD** main menu is displayed and CD playback is started.



Depending on the data stored on the audio **CD** or **MP3 CD**, more or less detailed information on the CD and the current music track are shown on the display.

#### Note

When an audio source is already active, you may toggle between the different audio sources by repeatedly pressing **SRCE**.

### Removing a CD

Press .

The CD is pushed out of the CD slot. If the CD is not removed after ejection, it will be drawn back in again automatically after a few seconds.

### Track List

Turn the multifunction knob to display a list of all tracks on the CD.



#### Note

The currently playing track is marked by .

Select the desired track.

## Function buttons

### Skipping to previous or next track

Press  or  once or several times to skip to the previous or next track.

### Fast forwarding or rewinding

Press and hold  or  to fast forward or rewind the current track.

### Pausing playback

Press  to pause playback.

### Audio menu

Press the multifunction knob to display the CD or MP3 menu.

#### Note

For a description of the functions in the MP3 menu  34.

### Shuffle function

To play the tracks on the CD in random order, activate **Shuffle**.

To return to the normal playing order, deactivate **Shuffle**.

## External devices

General information .....	32
Playing audio .....	34
Displaying pictures .....	35

### General information

Sockets for the connection of external devices are located in the centre console on a hinged panel.

#### Note

The sockets must always be kept clean and dry.

### AUX input

It is possible to connect e.g. an iPod, Smartphone or another auxiliary device with a 3.5 mm jack plug to the AUX input. The Infotainment system can play music files contained in auxiliary devices.

When connected to the AUX input, the audio signal of the auxiliary device is transmitted via the speakers of the Infotainment system.

The volume can be adjusted via the Infotainment system. All other control functions must be operated via the auxiliary device.

### Connecting a device

To connect the auxiliary device to the AUX input socket of the Infotainment system, use the following cable:

3-pole for audio source.

To disconnect the AUX device, select another function and then remove the AUX device.

### USB port

An MP3 player, USB device, iPod or Smartphone can be connected to the USB port. The Infotainment system can play music files or display pictures contained in auxiliary devices.

When connected to the USB port, the devices mentioned above can be operated via the controls and menus of the Infotainment system.

#### Note

Not all MP3 players, USB drives, iPod models or Smartphones are supported by the Infotainment system.

### Connecting/disconnecting a device

Connect the device to the USB port. For the iPod, use the appropriate connection cable.



**Note**

If a non-readable USB device or iPod is connected, a corresponding error message will appear and the Infotainment system will automatically switch to the previous function.

To disconnect the USB device or iPod, select another function and then remove the USB storage device.

**Caution**

Avoid disconnecting the device during playback. This may damage the device or the Infotainment system.

**Bluetooth**

Bluetooth enabled audio sources (e.g. music mobile phones, MP3 players featuring Bluetooth, etc.), which support the Bluetooth music profiles A2DP and AVRCP can be connected wirelessly to the Infotainment system.

The Infotainment system can play music files contained in Bluetooth devices, e.g. iPod or Smartphone.

**Connecting a device**

For a detailed description on the Bluetooth connection ↪ 65.

**File formats****Audio files**

Only devices formatted in the FAT32, NTFS and HFS+ file systems are supported.

**Note**

Some files may not be played properly. This might be due to a different recording format or the condition of the file.

Files from online shops to which Digital Rights Management (DRM) has been applied cannot be played.

The playable audio file formats are .mp3, .wma, .aac and .m4a.

When playing a file with ID3 tag information, the Infotainment system can display information, e.g. on the track title and artist.

**Picture files**

The displayable picture file formats are .jpg, .jpeg, .bmp, .png and .gif.

The files must have a maximum size of 2048 pixels in width and 2048 pixels in height (4MP).

**Gracenote**

The Gracenote database contains information on media data currently available on the market.

When connecting external devices, the tracks or files are recognised by the Gracenote function.

If the Gracenote normalisation function is activated, spelling mistakes in MP3 tag data are automatically corrected. Due to this, media search results may be improved.

Press **CONFIG** and then select **Radio Settings**.

Select **Gracenote Options** to display the respective submenu.

Activate the Gracenote normalisation function.

## Playing audio

### Starting playback

If not connected, connect the device  
↷ 32.

Press  and then select **USB**, **AUX** or **Bluetooth**.



Example: USB main menu



### Function buttons

The media files on the USB and Bluetooth devices may be operated using the buttons on the instrument panel.

### Skipping to previous or next track

Press  or  once or several times to skip to the previous or next track.

### Fast forwarding or rewinding

Press and hold  or  to fast forward or rewind the current track.

### Pausing playback

Press  to pause playback.

### Audio menus

To display the respective audio menu, press the multifunction knob.

#### Note

Not all menu items are available in all audio menus.



### Shuffle function

Press the multifunction knob to display the USB or Bluetooth menu.

To play the tracks on the respective device in random order, activate **Shuffle**.

To return to the normal playing order, deactivate **Shuffle**.

### Browsing

(only available in USB menus)

To search for a track within the structure, select one of the menu items, e.g. **Folders**, **Play Lists** or **Albums**.

Browse through the structure until you find the desired track.

Select the track to start playback.

### Individual playlists

The system allows new playlists to be created via the Gracenote function. Similar tracks are put together on a list automatically generated by the system.

Select the track around which you wish to create a new playlist.

Select **Play More Like This...** in the respective audio menu. A new playlist is created and stored in **Play Lists**.

To delete a playlist generated by the system, select **Delete automatic playlist**. A list of all generated playlists is displayed. Select the playlist you wish to delete. The playlist is deleted.

## Displaying pictures

### Viewing pictures

Connect a USB device ⇨ 32.

Press  and then select **Pictures** to open the **Picture Viewer USB** menu.

A list of all pictures and picture folders found on the USB device is displayed.

Browse through the pictures and folders until you find the desired picture and select it. The picture is displayed.



### Function buttons

#### Info button

Select **Info** at the bottom of the screen to display information on the picture stored on the USB device, e.g. a name or number. The respective information is displayed above the picture.

### Skipping to the previous or next picture

Select < or > at the bottom of the screen to display the previous or next picture.

### Slide show

To start a slideshow of all pictures stored in the respective picture folder, select ► at the bottom of the screen. The slideshow is started.

When the slideshow is started, ► changes to ||.

Select || to pause the slideshow.

### Rotating the picture

Select  at the bottom of the screen to rotate the picture.

### Picture menu

To display the picture menu, select **Menu** at the bottom of the screen.

### Picture Viewer Main

Select **Picture Viewer Main** to display a list of all picture folders, see above.

**Slideshow Timer**

To adjust the time sequence in which one picture is shown during a slide show, select **Slideshow Timer**. The respective submenu is displayed. Select the desired option.

**Shuffle Images**

To display the pictures of a slide show in random order, activate **Shuffle Images**.

## Navigation

General information .....	37
Usage .....	38
Destination input .....	42
Guidance .....	50

### General information

The navigation application will reliably guide you to your destination without the need to read maps.

The current traffic situation is taken into account in the route calculation. For this reason, the Infotainment system receives traffic announcements in the current reception area via RDS-TMC.

The navigation application cannot, however, take into account traffic incidents, traffic regulations changed at short notice and hazards or problems that arise suddenly (e.g. road works).

#### Caution

The usage of the navigation system does not release the driver from the responsibility for a correct, vigilant attitude in road traffic. The relevant traffic regulations must always be

followed. If a navigation instruction contradicts traffic regulations, the traffic regulations always apply.

### Functioning of the navigation application

The position and movement of the vehicle are detected by the navigation application using sensors. The travelled distance is determined by the vehicle's speedometer signal and turning movements on bends by a gyro sensor. The position is determined by the GPS satellites (Global Positioning System).

By comparing the sensor signals with the digital maps, it is possible to determine the position with an accuracy of approx. 10 metres.

The system will also work with poor GPS reception, however, the accuracy of the determination of the position will be reduced.

After the entry of the destination address or point of interest (nearest petrol station, hotel, etc.) the route is calculated from the current location to the destination selected.

Route guidance is provided by voice commands and a direction arrow, as well as with the aid of a multi-colour map display.

## Usage

### Information on the map display

To display the map around the current location, you may optionally:

- Press **NAV**.
- Press  and then select **Navigation**.

### Route guidance not active



If route guidance is not active, the following information is displayed:

- In the top line: information on the audio source currently active and the time.
- Below the top line: **GPS** symbol.
- In the upper left corner: a compass that indicates the north direction.
- Map display of the area around the current position.
- Current position: indicated by a red triangle within a grey circle.
- Points of interest (POI), e.g. petrol stations, parking areas or restaurants: indicated by corresponding symbols (if activated).
- In the bottom line: street name of the current position.

### Route guidance active



If route guidance is active, the following information is displayed:

- In the top line: information on the audio source currently active and the time.
- Below the top line: **GPS** symbol.
- Below the top line: name of the street to follow after the next intersection.
- In the upper left corner: a compass symbol that indicates the north direction.
- Map display of the area around the current position.

- Current position: indicated by a red triangle within a grey circle.
- Route: indicated by a blue line.
- Final destination: indicated by a black chequered flag.
- Waypoint (intermediate destination): indicated by a red diamond.
- Points of interest (POI), e.g. petrol stations, parking areas, or restaurants: indicated by corresponding symbols (if activated).
- Traffic incidents, e.g. traffic jam: indicated by corresponding symbols (if activated).
- On the left side: direction arrow and distance to the next manoeuvre.
- On the left side: remaining distance to the final destination or to the next waypoint.
- On the left side: estimated arrival time or remaining travel time.
- In the bottom line: street name of the current position.

## Map manipulation

### Moving the visible map section

The visible map section on the map display can be moved freely in all directions using the Eight-way switch.

The Eight-way switch in the middle of the multifunction knob may be tilted in all directions.

Tilt the switch to one side. The visible map section moves in the respective direction.

To redisplay the map around the current location, press **BACK**.

### Changing the map scale

When the map is displayed, turn the multifunction knob to display a scale bar at the bottom of the screen.

Turn the multifunction knob again to adjust the scale as desired.

### Changing the map mode

The map may be displayed in three (route guidance not active), or five (route guidance active) different modes, see "Map setup" below.

Repeatedly press **NAV** to toggle between the different map modes.

## Map setup

### Heading indicator

Press the multifunction knob to display the **Navigation Menu**. Select **Heading Indicator** to display the respective submenu.

The following options are available:

- **2D North Up**: 2D view, north facing upwards.
- **2D Heading Up**: 2D view, driving direction facing upwards.
- **3D Heading Up**: 3D view, driving direction facing upwards.

Select the desired option.

### Map modes

Press the multifunction knob to display the **Navigation Menu**. Select **Map Modes** to display the respective submenu.

The following options are available:

- **Full Map** ("Normal" view described above): Full screen map view, all functions and indication screen buttons displayed.
- **Full Glory**: Full screen map view, most functions and indication screen buttons hidden.
- **Split with Turn List**: Divided screen with map on the left and turn list on the right side.
- **Split with Turn Arrow**: Divided screen with map on the left side and turn arrow for the next turning manoeuvre on the right side.
- **Split with Media**: Divided screen with map on the left side and audio source currently active on the right side.

Select the desired option.

### Map display

Press the multifunction knob to display the **Navigation Menu**. Select **Map Settings** and then **Map Display** to display the respective submenu.

Depending on the external lighting conditions, activate **Day** or **Night**.

For an automatic adaption by the system, activate **Automatic**.

### Displaying POIs

Press the multifunction knob to display the **Navigation Menu**.

Select **Show POIs** to display the respective submenu.

If you wish all POIs available in the system to be displayed on the map, activate **Show all POIs**.

If you do not wish POIs to be displayed on the map, activate **Hide all POIs**.

To only display specific POIs, activate **User Defined** and then activate the POI categories you wish to be displayed.

### Changing screen information

The route information displayed on the screen during active route guidance may be customised.

Press the multifunction knob to display the **Navigation Menu**. Scroll through the list and select **Switch Route Time/Destination**.

### Time information

If you wish to change the time information displayed, select **Switch Arrival/Travel Time** to display the respective submenu.

Activate the information setting you wish to be displayed.

### Destination information

If you are in a waypoint trip, you may want to display the route information for a waypoint instead of those for the final destination.

To change the setting, select **Switch Waypoint/Destination**. A list of all destinations in the waypoint trip currently active is displayed.

Activate the information setting you wish to be displayed.



## Position information

### Current position

Press the multifunction knob to display the **Navigation Menu**. Select **Current Position Info**.

On the right side of the screen, the current position is displayed on the map. On the left side, the GPS coordinates of the current position are shown.

### Destination position

If route guidance is active, you may display information on the destination entered.

Press the multifunction knob to display the **Navigation Menu**. Select **Destination Position Info**.

On the right side of the screen, the destination is displayed on the map. On the left side, the address and the GPS coordinates of the destination are shown.

### Saving a position

The current position or a destination position may be saved in the address book.

Select **Save**. Find a detailed description on saving addresses in the address book ↗ 42.

## Route simulation

The Infotainment system features a route simulation mode for test purposes.

To start the simulation mode, press **CONFIG** and then select **Navigation Settings**.

Scroll through the list and select **Route Simulation** to display the respective submenu.

### Starting position

Since the simulation mode does not draw on the GPS signal providing the current position of the vehicle, a start position must be set manually.

### Use Last Known Position

To set the last position provided by a GPS signal as starting point, select **Use Last Known Position**.

## Use Previous Destination

To use one of the last destinations entered as starting point, select **Use Previous Destination**. The previous destinations list is displayed.

Select the desired address.

## Use Specified Location

To use a specific location as starting point, select **Use Specified Location**.

Enter an address. Find a detailed description ↗ 42.

Simulation mode is started.

## Cancelling simulation mode

To leave the simulation mode, press **CONFIG** and then select **Navigation Settings**.

Scroll through the list and select **Route Simulation** to display the respective submenu.

Select **Cancel Route Simulation**.

## Additional route simulation menu

When route guidance is active in the simulation mode, an additional menu is displayed in the **Navigation Menu**.

Press the multifunction knob to display the **Navigation Menu**. Scroll through the list and select **Route Simulation** to display the respective submenu.

To stop the simulated route guidance, select **Stop Simulation**. The guidance process is stopped, the route guidance mode remains active.

To display the next simulated turning manoeuvre on the map, select **Next Manoeuvre**.

## Destination input

The **Destination** application provides different options to set a destination for route guidance.

Press **DEST / NAV** (when route guidance is not active) to display the **Destination Entry** menu.



### Manual address entry

#### Address Entry menu

Press **DEST / NAV** to display the **Destination Entry** menu and then select **Address Entry** to display a mask for address entry.



Select the Country entry field. A list is displayed. Select the desired country.

Select the City/Postal entry field to display a keyboard. Enter the desired city name or postal code (see below).

Select the Street entry field to redisplay the keyboard. Enter the desired street name (see below).

You may then enter a house number or junction.

Select the House number or Junction entry field. The keyboard is redisplayed. Enter the desired number or street name (see below).

**Note**

If a house number is not stored in the system database, the house number closest to the destination entered is used for route calculation.

If required, confirm your input.

A confirmation menu is displayed. Select **Start Guidance** to start route guidance.

**Keyboard**

Depending on the function selected, the keyboards may be displayed differently.



To change the letter arrangement on the letter keyboard, select **ABC** on the left side of the keyboard. The letters are now arranged in alphabetical order.

To enter a character sequence, successively select the desired characters.

**Note**

When entering an address, the keyboard uses an intelligent spelling function which automatically blocks out characters that cannot occur next in the respective character sequence.

To enter special characters not available on the letter keyboard, select **ÄÖ** at the right side of the letter keyboard. The special characters keyboard is displayed. Select the desired character.

To enter numbers or symbols, select **Sym** at the right side of the special characters keyboard. The symbols keyboard is displayed. Select the desired character.

To redisplay the letter keyboard, select **ABC** at the right side of the symbol keyboard. This way you may toggle between the three keyboards.

To delete characters already entered, select **Delete** at the right side of the respective keyboard or press **BACK** on the instrument panel.

When entering an address, a list of matching entries is automatically displayed as soon as the number of matching entries found in the address memory is equal to or less than six.

To manually display a list of matching entries for the current input, select the respective **List** screen button at the bottom of the keyboard.

To display the last five entries made, select **Last 5** at the bottom of the keyboard.

Select the desired entry from the list.

If required, select the confirmation button displayed at the bottom of the keyboard.

## Points of Interest

A point of interest is a specific location that might be of general interest, e.g. a petrol station, parking area or restaurant.

The data stored within the Infotainment system contain a great number of predefined POIs which are indicated by symbols on the map.

These POIs may be selected as destinations for route guidance.

### Search menu

A POI may be selected using different search masks.

Press **DEST / NAV** to display the **Destination Entry** menu and then select **Points of Interest** to display the **POI List** menu.

Select **Category:**, **Name:** or **Telephone number**. The respective search mask is displayed.



Fill out the entry fields in the respective search mask.

### Category search mask

Select the Location entry field to display a list. Select the desired option.

Select the Category entry field to display a POI category list. Select the desired category and then a subcategory from the list.

Select the Sort Method entry field to display the respective submenu. Select **By Distance** or **By Name**.

Select **Search** at the bottom of the screen. A list of POIs or POI categories is displayed corresponding to the criteria entered. Select the desired menu item.

### Name search mask

Select the Country entry field to display a list of all available countries. Select the desired country.

To specify the location, select the entry field for the city or postal code. A keyboard is displayed. Enter the desired name or number.

Select the Sort Method entry field to display the respective submenu. Select **By Distance** or **By Name**.

Select **Search** at the bottom of the screen. The keyboard is redisplayed. Enter the name of the desired POI.

### Telephone number search mask

Select the Country entry field to display a list of all available countries. Select the desired country.

Select the Sort Method entry field to display the respective submenu. Select **By Distance** or **By Name**.

Select the Number entry field to display a keypad. Enter the desired number.

When the respective search mask is filled out, a confirmation menu is displayed.

Select **Start Guidance** to start route guidance.

### Category lists

Press **NAV** and then the multifunction knob to display the **Navigation Menu**. Select **Nearby POIs** or **POIs Along Route**. A POI category list is displayed.

Select the desired category, subcategories and then POI.

A confirmation menu is displayed. Select **Start Guidance** to start route guidance.

### Previous Destinations

The last destinations selected or entered for route guidance are stored within the system.

Press **DEST / NAV** to display the **Destination Entry** menu and then select **Previous Destinations**.

A list of the last destinations is displayed sorted in reverse chronological order.

Select the desired address from the list.

A confirmation menu is displayed. Select **Start Guidance** to start route guidance.

### Address Book

The **Address Book** provides local storage space for addresses entered in the navigation application.

#### Storing addresses in the address book

To store an address in the address book, press **DEST / NAV** to display the **Destination Entry** menu.

Enter or select the desired address. The confirmation menu is displayed.



Select **Save**. The **Address Book Entry** mask is displayed.



Depending on the information available, the different entry fields are already filled.

To enter or modify the name of the respective location, select the Name entry field. A keyboard is displayed. Enter the desired name and confirm your input.

To modify the address, select the Address entry field. The address entry mask is displayed. Make your changes and confirm your input.

To enter or modify the phone number, select the Number entry field. A keypad is displayed. Enter the desired number.

If activated ⇨ 38, the address book entries are indicated on the map by POI icons. To change the icon indicating an address entry, select the Icon entry field. A list of all POI icons available within the system is displayed.

Scroll through the list and select the desired icon.

Select **Done** at the bottom of the entry mask. The address is stored.

### Selecting addresses from the address book

Press **DEST / NAV** to display the **Destination Entry** menu and then select **Address Book**. A list of all address book entries is displayed.



Select the desired entry.

A confirmation menu is displayed. Select **Start Guidance** to start route guidance.

### Editing addresses in the address book

Press **DEST / NAV** to display the **Destination Entry** menu and then select **Address Book**. A list of all address book entries is displayed.

Select the desired entry.

A confirmation menu is displayed. Select **Edit** to display the **Address Book Entry** mask.

Make your changes and confirm your input. The changes are stored in the address book.

### Phone Book

Addresses stored in the phone book of the mobile phone connected may be selected as destinations.

Press **DEST / NAV** to display the **Destination Entry** menu and then select **Phone Book**. The **Phone Book Search** menu is displayed.

Select the desired first letter range to display a preselection of the telephone book entries you wish to be displayed. The phone book jumps to the position of the letter range selected.



Select the desired entry in the telephone book to display the address saved under this entry.  
Select the address.

### Note

When the Infotainment system cannot find a valid address, you are prompted with a message.

A confirmation menu is displayed. Select **Start Guidance** to start route guidance.

## Destination selection from the map

Destinations (addresses or POIs) may also be set via the map.

Press **NAV** to display the map.

Use the Eight-way switch to centre the map around the desired destination. A red  is indicated on the map and the corresponding address is displayed on a label.



Press the multifunction knob to activate **Go**.

A confirmation menu is displayed. Select **Start Guidance** to start route guidance.

### Note

If there is more than one POI located at the map position selected, this is indicated on the label. Activating **Go** then opens a list for selection.

## My Home

You can permanently store your home address in the system.

### Storing the home address

Press **DEST / NAV** to display the **Destination Entry** menu.

Enter your home address.

A confirmation menu is displayed. Select **Save as Home**.

You are prompted with a message. Confirm the message to save your home address.

### Note

The home address is also stored in the address book.

### Selecting the home address

Press **DEST / NAV** to display the **Destination Entry** menu and then select **My Home**.

Route guidance to the home address is started immediately.

## Waypoint routes

When a destination has been entered and route guidance is active, intermediate destinations (waypoints) may be added to the route.

To set up a waypoint route during active route guidance, press **DEST / NAV** to open the **Route Menu** and then select **Destination List**. A submenu is displayed.

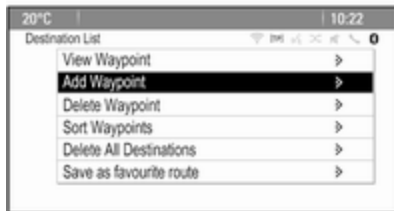

## Adding waypoints

To add an intermediate destination, select **Add Waypoint**. The waypoint list is displayed.



Select **Add** at the position where you wish to add a waypoint. The **Destination Entry** menu is displayed.

Enter or select the desired destination. The confirmation menu is displayed.

Select **Add**. The route is recalculated and the waypoint list is redisplayed with the intermediate destination at the position selected.

## Note

Up to four destinations may be stored in a waypoint list.

## Deleting waypoints

To delete a waypoint, select **Delete Waypoint**. The waypoint list is displayed.

Select **Delete** next to the waypoint you wish to delete.

The waypoint is deleted and the waypoint list is redisplayed.

To delete the whole list and end route guidance, select **Delete All Destinations**.

## Moving waypoints

To change the order of the waypoints in the route, select **Sort Waypoints**.

Select **Move** next to the waypoint you wish to move. The **Add Waypoint** menu is displayed.

Select **Add** at the position where you wish to drop the respective waypoint.

The route is recalculated and the order of the waypoints in the waypoint list is changed.



## Favourite Routes

### Storing waypoint routes

A waypoint route created (see above) may be saved as favourite route.

During an active waypoint route, press **DEST / NAV** to open the **Route Menu** and then select **Destination List**. A submenu is displayed.

Select **Save as favourite route**. A keyboard is displayed.

Enter a name for the favourite route and confirm your input.

The waypoint route is saved.

### Creating new favourite routes

Press **DEST / NAV** to display the **Destination Entry** menu and then select **Favourite Routes** to display the **Favourite Route** menu.

Select **New Favourite Route**. A keyboard is displayed.



Enter a name for the favourite route and confirm your input. The **Favourite Route** menu is redisplayed.

Select the desired favourite route. A menu is displayed.



Create a waypoint route (see above). To change the name of the respective favourite route, select **Edit Name**. The keyboard for name entry is displayed. Enter the desired name and confirm your input.

To delete the respective favourite route, select **Delete Favourite**. The favourite route is deleted and the **Favourite Route** menu is redisplayed.

### Selecting a favourite route

Press **DEST / NAV** to display the **Destination Entry** menu and then select **Favourite Routes** to display a list of the favourite routes saved.

Select the desired route from the list. The route confirmation menu is displayed.

To start route guidance, select **Start Guidance**.

### Latitude / Longitude

The GPS coordinates of a desired location may be used to set a destination.

Press **DEST / NAV** to display the **Destination Entry** menu and then select **Latitude**.

Select the Latitude entry field to display the **Geolocation Entry** menu.



Repeatedly press the multifunction knob to adjust the first setting as desired.

Turn the multifunction knob to move to the next value to be set.

Proceed like this to set all values.

Select **BACK** to return to the next higher menu level.

Adjust the longitude values as described above.

When all GPS coordinates are entered, select **Search** at the bottom of the screen.

A confirmation menu is displayed.

To start route guidance, select **Start Guidance**.

### Deleting saved destinations

To delete destinations stored in the system, press **CONFIG**, select **Navigation Settings** and then **Delete Saved Destinations**. A submenu is displayed.

Activate the menu items of the storage location you wish to be cleared.

Select **Delete**. The selected storage locations are cleared.

## Guidance

### Starting and cancelling route guidance

#### Starting route guidance

Enter or select the desired address.

A confirmation menu is displayed. Select **Start Guidance** to start route guidance.



### Cancelling route guidance

When route guidance is active, press **DEST / NAV** to display the **Route Menu**.

Select **Cancel Route** to cancel the current navigation session.

### Guidance instructions

Route guidance is provided by voice prompts and visual instructions on the map (if activated).

### Voice prompts

Navigation voice prompts announce which direction to follow, when approaching an intersection at which you need to turn.

Press **CONFIG** and then select **Navigation Settings**.

Select **Voice Prompt** to display the respective submenu.

If you wish the system to audibly indicate the next turning manoeuvre, activate **Navigation Voice Prompts**.

If you wish traffic alerts to be read out, activate **Traffic Alert Prompts**.

To adjust the volume during voice prompts, select **Navigation Volume**. The respective submenu is displayed.

To adjust the volume of voice prompts, select **Announcement** and then adjust the setting as desired.

To adjust the volume of the audio source possibly playing in the background, select **Background** and then adjust the setting as desired.

Select **Volume Test** to get an audio example of the settings.

### Guidance alerts

Guidance alerts show in a close-up view of the respective map section which direction to follow when approaching an intersection at which you need to turn.

Press **CONFIG** and then select **Navigation Settings**.

Select **Guidance Alert** to display the respective submenu.

If you wish the display to automatically show the map when approaching the next turning manoeuvre, activate **Guidance Alert in Primary**.

If you wish turning manoeuvres to be displayed in a close-up view, activate **Guidance Alert in Map**.

### Traffic incidents

The TMC traffic information system receives all current traffic information from TMC radio stations. This information is included in the calculation of a route.

### Traffic settings

Press **CONFIG** and then select **Navigation Settings**.

Select **Traffic Settings** to display the respective submenu.

To use the TMC traffic information system, activate **Traffic Events**.

### Recalculation of an active route

If a traffic problem occurs during active route guidance, the route may be changed.

Select **Alert if better route is available** to display the respective submenu.

If you wish the route to be constantly adapted to the current traffic situation, activate **Route Based on Traffic Conditions**.

Choose between **Automatic Recalculation** and **Recalculation after Confirmation** of a corresponding message.

### Traffic incidents on the map

Traffic incidents may be indicated on the map by corresponding symbols.

Select **Show Traffic Events on Map** to display the respective submenu.

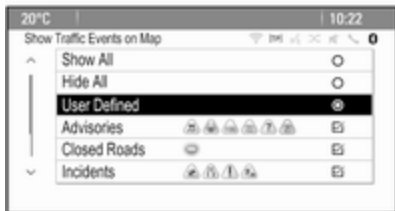

Select the desired option.

If **User Defined** is activated, scroll through the list and activate the traffic incidents categories you wish to be displayed.

### TMC stations

The TMC stations broadcasting traffic information, may be set automatically or manually.

Select **Traffic Stations** to display a selection mask.

Select the Mode entry field to display the respective submenu. Select the desired option.

If **Manual Station Selection** is chosen, a TMC station needs to be set.

Select the Station entry field to display the **Traffic Station List**.

Select the desired station.

### Traffic incidents lists

When route guidance is active, press **NAV** and then press the multifunction knob to display the **Navigation Menu**. Scroll through the list and select **Traffic**.

To display a list of all traffic events known for the area around the current vehicle location, select **All Traffic Events**.

To display a list of the traffic events concerning the current route, select **Traffic Events on Route**.

The traffic incidents lists may be sorted in different ways.

Select **Traffic Settings** in the **Traffic** menu and then **Sort Method**. The respective submenu is displayed.

Activate the desired option.

### Route tracking

The bread crumbs function allows tracking of the roads already taken in a route.

Press **CONFIG** and then select **Navigation Settings**. Select **Bread Crumbs** to display the respective menu.

To start a tracking session, activate **Record**. The route taken is recorded and displayed as dotted line on the map.



To delete the bread crumbs already dropped in an active tracking session, select **Delete**. You are prompted with a message. Confirm the message to delete all bread crumbs.

To end the tracking session, deactivate **Record**. A keyboard is displayed.

Enter a name for the respective tracking session and select **Done**. The session is stored in the **Saved** list.

To display a list of all tracking sessions, select **Saved**. Select the desired tracking session to display the **Bread Crumb Details** menu.

To change the name of the respective tracking session, select **Edit Name**. A keyboard is displayed. Enter the desired name and select **Done**.

Select **Load** to display the bread crumb main menu. If you wish the respective tracking session to be constantly displayed on the map, activate **Display**.

To directly display the whole tracking session in the respective map section, select **Show on Map**.

To delete the respective tracking session, select **Delete**.

## Routing

When a route has been calculated, you may manually change certain parts or recalculate the whole route.

## Turn List

The **Turn List** displays all streets and turning manoeuvres on the calculated route starting from the current location.

Press **DEST / NAV** and then select **Turn List**. The turn list is displayed.

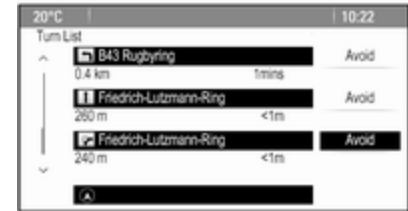

To exclude certain streets from the route, select **Avoid** next to the respective street.

The route is recalculated and the respective street is excluded.

## Avoid List

When streets have been excluded from the original route, they are displayed in the **Avoid List**.

Press **DEST / NAV** and then select **Avoid List** to display the respective submenu.

To display all streets avoided, select **View List**.

To delete all avoidances and return to the original route, select **Delete All Items**.

### Detour

Press **DEST / NAV** and then select **Detour**.

To change the route for a certain distance, select **Detour By Distance**. A menu listing different distances is displayed.

Select the desired distance. The route is recalculated accordingly.

To block the whole route, select **Detour Complete Route**. The original route is blocked and a new route to the desired destination is calculated.

### Exit list

To display a list of the next exits and motorway stations while driving on a motorway, press **NAV** and then press the multifunction knob to display the **Navigation Menu**.

Scroll through the list and select **Exit List**.

### Route options

When route guidance is active, press **DEST / NAV** and then select **Route Options**.

A list of route calculation options and road types is displayed.

To define by what criteria a route may be calculated, activate one of the options: **Fastest** for the fastest route (in time), **Shortest** for the shortest route (in distance) or **Eco** for the route with the lowest fuel consumption.

To define which road types may be included in the calculation of the route, activate the desired options: highways, tollroads, ferries, etc.

## Speech recognition

General information .....	55
Usage .....	56
Speech commands overview .....	59

## General information

### Embedded speech recognition

The speech recognition of the Infotainment system enables you to operate various functions of the Infotainment system via voice input. It recognises commands and numeric sequences independently of the relevant speaker. The commands and numeric sequences can be spoken without a pause between the individual words.

In the event of incorrect operation or commands, the speech recognition gives visual and/or acoustic feedback and requests you to re-enter the desired command. Apart from this, the speech recognition acknowledges important commands and will enquire if necessary.

In general, there are different ways to speak commands for completing the tasks. Most of them, except destination entry and voice keypad, can be completed in a single command.

If the action takes more than one command to be performed, proceed as follows:

In the first command, you indicate the type of action to be performed, e.g. "Navigation destination entry". The system replies with prompts that lead you through a dialogue for entering the necessary information. For example, if a destination for route guidance is needed, say "Navigation" or "Destination entry".

### Note

To ensure that conversations inside the vehicle do not lead to unintentional triggering of the system functions, the speech recognition does not start until it has been activated.

### Language support

- Not all languages available for the display of the Infotainment system are also available for the speech recognition.
- If the currently selected display language is not supported by the speech recognition, speech recognition is not available.

In such a case you must select another language for the display if you want to control the Infotainment system via voice input. Changing the display language, see "Language" in chapter "System settings" ⇨ 21.

### Address input for destinations in foreign countries

In case you want to enter the address of a destination located in a foreign country via voice input, you must change the language of the Infotainment display to the language of the foreign country.

E.g. if the display is currently set to English and you want to enter the name of a city located in France, you must change the display language to French.

Exceptions: If you want to enter addresses in Belgium, you may optionally change the display language to French or Dutch. For addresses in Switzerland you may optionally change the display language to French, German, or Italian.

For changing the display language, see "Language" in chapter "System settings" ⇨ 21.

### Input order for destination addresses

The order in which the parts of an address must be entered using the speech recognition system is dependent on the country where the destination is located.

An example for the respective input order is given out by the system.

### Voice pass-thru application

The voice pass-thru application of the Infotainment system allows access to the speech recognition commands on your smartphone. See the operating instructions for your smartphone to find out whether your smartphone supports this feature.

## Usage

### Embedded speech recognition

#### Activating speech recognition

##### Note

Speech recognition is not available during an active phone call.

Press  on the right side of the steering wheel.

The audio system mutes,  on the display is highlighted, and a voice output message prompts you to say a command.

As soon as the speech recognition is ready for voice input, a beep is heard.

You can now say a voice command to directly initiate a system function (e.g. playing a radio station), or to start a dialogue sequence with several dialogue steps (e.g. entering a destination address), see "Operation via speech commands" further below.



After a dialogue sequence is finished, the speech recognition is deactivated automatically. To initiate another dialogue sequence, you must activate the speech recognition again.

### Adjusting the volume of voice prompts

Press + or – on the right side of the steering wheel.

### Interrupting a voice prompt

As an experienced user, you can interrupt a voice prompt by briefly pressing  $\text{⌘}$  on the steering wheel.

A beep is heard immediately, and a command can be stated without having to wait.

### Cancelling a dialogue sequence

There are several possibilities to cancel a dialogue sequence and to deactivate the speech recognition:

- Say "Cancel" or "Exit".
- Press  $\text{⌘}$  on the right side of the steering wheel.

In the following situations a dialogue sequence is automatically cancelled:

- If you do not say any commands for some time (by default you are prompted three times to say a command).
- If you say commands that are not recognised by the system (by default you are prompted three times to say a correct command).

### Operation via speech commands

The speech recognition can understand commands that are either naturally stated in sentence form, or direct commands stating the application and the task.

For best results:

- Listen for the voice prompt and wait for the beep before saying a command or replying.
- Say "Help" if you want to listen again to the help prompt for the current dialogue step.

- The voice prompt can be interrupted by pressing  $\text{⌘}$  again. If you wish to directly speak your command, press  $\text{⌘}$  twice.
- Wait for the beep and then speak the command naturally. In most cases, recognition rates will be higher if pauses are kept to a minimum. Use short and direct commands.

Usually phone and audio commands can be spoken in a single command. For example, "Call David Smith at work", "Play" followed by the artist or song name, or "Tune to" followed by the radio frequency and the waveband.

Navigation destinations, however, are too complex for a single command. First, state "Navigation" and then, e.g. "Address" or "Point of Interest". The system responds with requesting more details.

After saying "Point of Interest", only major chains may be selected by name. Chains are businesses with at least 20 locations. For other POIs,

say the name of a category, e.g. "Restaurants", "Shopping centres", or "Hospitals".

Direct commands are easier understood by the system, e.g. "Call 01234567".

If you say "Phone", the system understands that a phone call is requested and responds with respective questions until enough details are gathered. If the phone number has been saved with a name and a place, the direct command should include both, for example "Call David Smith at work"

### Selecting list items

When a list is displayed, a voice prompt asks to confirm or select an item from that list. A list item may be manually selected, or by speaking the line number of the item.

The list on a speech recognition screen functions the same as a list on other screens. Manually scrolling the list on a screen during a speech recognition session suspends the current speech recognition event and plays a prompt like "Make your

selection from the list using the manual controls, or press the back button on the faceplate to try again".

If no manual selection is made within 15 seconds, the speech recognition session terminates, you are prompted with a message, and the former screen is redisplayed.

### The "Back" command

To return to the previous dialogue step, alternatively: say "Back", or press **BACK** on the instrument panel.

### The "Help" command

After saying "Help", the help prompt for the current dialogue step is read aloud.

To interrupt the help prompt, press  $\#$  again. A beep is heard. You may say a command.

## Voice pass-thru application

### Activating the voice pass-thru speech recognition

Press and hold  $\#$  on the right side of the steering wheel.

Find further information in the operating instructions for your smartphone.

### Adjusting the volume of voice prompts

Press + or – on the right side of the steering wheel.

### Deactivating the voice pass-thru speech recognition

Press  $\#$  on the right side of the steering wheel. The speech recognition session is ended.

## Speech commands overview

The table below contains an overview of the most important speech commands.

Menu	Action	Speech commands
All menus	Confirming a system question	(Yes   Right   OK   Yeah   Yep   Correct)
	Negating a system question	(No   Incorrect   Wrong   Nope)
	Cancelling a session	Cancel
	Returning to previous step	([Go] Back   Return   Previous)
	Asking for assistance	(Help   Assistance)   (Help   Assist) Me More Commands
	Activating or deactivating "Verbose"	[Set] Verbose On [Set] Verbose Off
	Requesting the current music source	("What's"   What is) playing [now]

Menu	Action	Speech commands
Radio menu	Selecting a waveband	[Tune [to]   Select] F M [Radio] [Tune [to]   Select] A M [Radio] [Tune [to]   Select] D A B [Radio]
	Selecting a station	Tune F M ... Tune A M ... Tune D A B ...
Media menu	Selecting a media source	[Play   Select] C D [Play   Select] U S B [Play   Select] [Front] AUX [Play   Select] Bluetooth Audio
	Selecting a search category	Play Artist ... Play Album ... Play Genre ... Play Folder ... Play Playlist ... Play Composer ... Play Audiobook ...
	Selecting a song	Play Song ...

Menu	Action	Speech commands
Navigation menu	Entering a destination	<p>Directed [Destination] Address [entry]   (enter   go to   navigate to) [Destination] Address Directed</p> <p>(Navigation   Destination), [Destination] Address [entry]   (Enter   Go to   Navigate to) [Destination] Address</p> <p>(Navigation   Destination), [Destination] (Intersection   Junction)</p>
	Entering a POI	<p>(Navigation   Destination), (P O I   (Place   Point) of Interest)</p> <p>(Navigation   Destination), (P O I   (Place   Point) of Interest) (nearby   near me)</p> <p>(Navigation   Destination), (P O I   (Place   Point) of Interest) (around   near) destination</p> <p>(Navigation   Destination), (P O I   (Place   Point) of Interest) along [the] (route   way)</p>
	Entering the home address	(Navigation   Destination), [Go] [to] Home
	Asking for the current location	(Navigation   Destination), Where am I   [My] Current Location   What is My Current Location

Menu	Action	Speech commands
Navigation menu	Adding a waypoint	<p>(Navigation   Destination), Add Waypoint Directed Address</p> <p>(Navigation   Destination), Add Waypoint ([Destination] Address [entry]   (Enter   Go to   Navigate to) [Destination] Address)</p> <p>(Navigation   Destination), Add Waypoint (P O I   (Place   Point) of Interest)</p> <p>(Navigation   Destination), Add Waypoint (Intersection   Junction)</p> <p>(Navigation   Destination), Add Waypoint [(Go   Navigate) to] Contact</p> <p>(Navigation   Destination), Add Waypoint [(Go   Navigate) [to]] Home</p>
	Deleting a waypoint	(Navigation   Destination), Delete Waypoint
	Cancelling route guidance	(Navigation   Destination), (Stop   Cancel   Turn Off   End) (Navigation   [My] [Current] Route   Directions   Route Guidance)
	Activating/ deactivating voice guidance	[Set   Turn] Voice Guidance On
		[Set   Turn] Voice Guidance Off

---

<b>Menu</b>	<b>Action</b>	<b>Speech commands</b>
Phone menu	Pairing device	<b>(Pair   Connect) [Device]</b>
	Dialling a number	<b>Digit Dial</b> <b>(Call   Dial   Ring) ...</b>
	Redialling the last number	<b>Redial [Last Number]</b>
	Erasing digits	<b>(Clear   Erase)</b> <b>(Clear   Erase) All</b>
	Reading a text message	<b>[Read] (Messages   Texts   S M S)</b>

---

... : dynamic spacer stands for the specific names to be inserted in that position

| : vertical bar separates alternatives

() : round brackets embrace alternatives

[] : square brackets designate optional parts in a command

, : comma separates necessary steps in a sequence

## Phone

General information .....	64
Bluetooth connection .....	65
Emergency call .....	66
Operation .....	67
Mobile phones and CB radio equipment .....	70

### General information

The Phone portal provides you with the possibility of having mobile phone conversations via a vehicle microphone and the vehicle loudspeakers as well as operating the most important mobile phone functions via the Infotainment system in the vehicle. To be able to use the Phone portal, the mobile phone must be connected with it via Bluetooth.

The Phone portal can be operated optionally via the speech recognition system.

Not all Phone portal functions are supported by every mobile phone. The possible phone functions depend on the relevant mobile phone and network provider. You will find further information on this in the operating instructions for your mobile phone or you can enquire about them with your network provider.

### Important information for operation and traffic safety

#### Warning

Mobile phones have effects on your environment. For this reason safety regulations and directions have been prepared. You should be familiar with the related directions before you use the telephone function.

#### Warning

Use of the hands-free facility while driving can be dangerous because your concentration is reduced when telephoning. Park your vehicle before you use the hands-free facility. Follow the stipulations of the country in which you find yourself at present.

Do not forget to follow the special regulations that apply in specific areas and always switch off the mobile phone if the use of mobile



phones is prohibited, if interference is caused by the mobile phone or if dangerous situations can occur.

## Bluetooth

The Phone portal is certified by the Bluetooth Special Interest Group (SIG).

You will find further information about the specification on the Internet at <http://www.bluetooth.com>

## Bluetooth connection

Bluetooth is a radio standard for the wireless connection of e.g. mobile phones, iPod/iPhone models, or other devices.

To be able to set up a Bluetooth connection to the Infotainment system, the Bluetooth function of the Bluetooth device must be activated. For further information, please consult the user guide of the Bluetooth device.

Via the **Bluetooth** menu, pairing (PIN code exchange between Bluetooth device and Infotainment system) and connecting of the Bluetooth devices to the Infotainment system are carried out.

## Important information

- Up to five devices can be paired to the system.
- Only one paired device can be connected to the Infotainment system at a time.
- Pairing normally only needs to be carried out once, unless the device is deleted from the list of paired devices. If the device has been connected previously, the Infotainment system establishes the connection automatically.
- Bluetooth operation considerably drains the device's battery. Therefore, connect the device to the power outlet for charging.

## Bluetooth menu

To open the **Bluetooth** menu, press **CONFIG**. Select **Phone Settings** and then **Bluetooth**.

The menu items **Device list** and **Pair device** are displayed.

## Pair device

To initiate the pairing process on the Infotainment system, select **Pair device**. A message with a four-digit Infotainment system code is displayed.

Initiate the pairing process on the Bluetooth device. If required, enter the Infotainment system code on the Bluetooth device.

A six-digit PIN code for the pairing process is displayed on the Infotainment system.

To confirm the pairing process:

- If SSP (secure simple pairing) is supported:

Compare the PIN codes displayed on the Infotainment system and on the Bluetooth device (if demanded)

and confirm the message on the Bluetooth device.

- If SSP (secure simple pairing) is not supported:

Enter the PIN code on the Bluetooth device and confirm your input.

The devices are paired and the phone main menu is displayed.

The phone book and call lists (if available) are downloaded from the Bluetooth device.

If required, confirm the corresponding message on the Bluetooth device.

### Device list

The device list contains all Bluetooth devices paired to the Infotainment system.



If a new device is paired, it is displayed in the device list.

### Connecting a device

Select the device you wish to connect. A submenu is displayed.

Select **Select**.

The device previously connected is disconnected and this device is connected.

### Deleting a device

Select the device you wish to delete. A submenu is displayed.

Select **Delete**.

The device is deleted.

## Emergency call

### ⚠ Warning

Connection setup cannot be guaranteed in all situations. For this reason you should not rely exclusively on a mobile phone when a vitally important communication (e.g. a medical emergency) is concerned.

In some networks it may be necessary for a valid SIM card to be properly inserted in the mobile phone.

### ⚠ Warning

Bear in mind that you can make and receive calls with the mobile phone, if it is in a service area with a sufficiently strong signal. Under certain circumstances emergency calls cannot be made on all mobile phone networks; it is possible that they cannot be made when certain network services and/or telephone

functions are active. You can enquire about this with the local network operators.

The emergency call number can differ depending on the region and country. Please enquire beforehand about the correct emergency call number for the relevant region.

### Making an emergency call

Dial the emergency call number (e.g. 112).

The telephone connection to the emergency call centre is set up.

Answer when the service personnel questions you about the emergency.

#### Warning

Do not end the call until you are requested to do so by the emergency call centre.

## Operation

As soon as a connection via Bluetooth has been set up between your mobile phone and the Infotainment system, you can also operate many functions of your mobile phone via the Infotainment system.

After setting up a connection between the mobile phone and the Infotainment system, the mobile phone data is transmitted to the Infotainment system. This can take some time depending on the phone model. During this period, operation of the mobile phone is possible via the Infotainment system only to a limited extent.

Not every telephone supports all functions of the phone application. Therefore, deviations from the range of functions described are possible.

### Phone main menu

To display the phone main menu, press . The following screen is displayed (if a mobile phone is connected).

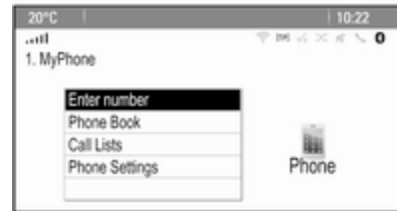

### Initiating a phone call

#### Entering a number

Press  and then select **Enter number**. A keypad is displayed.



Enter the desired number.

Select **Del** on the screen or press **BACK** on the instrument panel to delete the last digit entered.

Select **▶** or **◀** on the screen to move the cursor within the number already entered.

To start dialling, select **OK**.

#### Note

You may access the phone book from the keypad by pressing **PB**.

#### Phone book

Press **☎** and then select **Phone Book**. The **Phone Book Search** menu is displayed.



Select the desired first letter range to display a preselection of the telephone book entries you wish to be displayed. The phone book jumps to the position of the letter range selected.



Select the desired entry in the telephone book to display the numbers saved under this entry.

Select the desired number to start dialling.

#### Phone book sorting

The phone book may be sorted by last name or by first name.

To change the sorting order, select **☎** and then **Phone Settings**.

Select **Sort Order** to display the respective submenu.

Activate the desired option.

## Call lists

Press and then select **Call Lists**. The **Call Lists** menu is displayed.



Select the desired call list. Depending on the list selected, the last incoming, outgoing or missed calls are displayed.

Select the desired entry in the call list to start dialling.

## Incoming calls

When a call comes in, a message is displayed on the screen.



To take the call, select **Answer**.

To reject the call, select **Decline**.

## Functions during a phone call

When a call is active, the in-call view is displayed.



## Ending a phone call

To end the call, select **Hang up**.

## Muting a call

To temporarily mute the microphone, activate **Mute call**.

Deactivate **Mute call** to unmute the microphone.

## Transferring to handset

Select **Transfer to Handset** to transfer the call to the mobile phone. The **Private Call** menu is displayed.

To transfer the call back to the Infotainment system, select **Transfer call** in the **Private Call** menu.

## Second phone call

### Initiating a second phone call

While a call is active, select **Enter number** in the in-call view. The keypad is displayed. You may enter a number or select a number from the phone book, see above.

### Second incoming phone call

When a second call comes in, a message is displayed at the bottom of the screen.

Select the desired option.

If the call is taken, the first call is put on hold and the second call becomes active.

Both calls are displayed in the in-call view.



To switch between the calls, select **Switch calls**.

### Conference call

Select **Merge calls** to activate both calls at the same time.

**Merge calls** changes to **Detach call**.

To end a conference call, select **Detach call**.

### Ending phone calls

In a conference call, select **Hang up** to end both phone calls.

## Mobile phones and CB radio equipment

### Installation instructions and operating guidelines

The vehicle specific installation instructions and the operating guidelines of the mobile phone and handsfree manufacturer must be observed when installing and operating a mobile telephone. Failure to do so could invalidate the vehicle type approval (EU directive 95/54/EC).

Recommendations for fault-free operation:

- The exterior antenna needs to be professionally installed to obtain the maximum range possible.
- Maximum transmission power: 10 watts.
- The mobile phone needs to be installed in a suitable spot. Consider relevant note in the Owner's Manual, section **Airbag system**.

Seek advice on predetermined installation points for the external antenna or equipment holder and ways of using devices with a transmission power exceeding 10 watts.

Use of a handsfree attachment without external antenna with mobile telephone standards GSM 900/1800/1900 and UMTS is only permitted if the maximum transmission power of the mobile telephone is 2 watts for GSM 900 or 1 watt for the other types.

For reasons of safety, do not use the phone while driving. Even use of a handsfree set can be a distraction while driving.

### **Warning**

Operation of radio equipment and mobile telephones which fail to meet above mentioned mobile telephone standards is only permitted using an antenna located outside of the vehicle.

### **Caution**

Mobile telephones and radio equipment may lead to malfunctions in the vehicle electronics when operated inside the vehicle with no exterior antenna, unless the above mentioned regulations are observed.

## Frequently asked questions

Frequently asked questions ..... 72

## Frequently asked questions

### Speech recognition

❓ **The speech recognition function does not work very well. How can I improve its performance?**

❗ Wait for the beep and then try to speak the command naturally. Avoid long pauses, use little accentuation and speak at a moderate volume.

Detailed description ⇨ 56.

❓ **The voice prompts given out by the speech recognition system are too long. How can I interrupt them to directly speak a command?**

❗ To interrupt the voice prompt of the speech recognition system, press  on the steering wheel. Wait for the beep and then speak your command.

Detailed description ⇨ 56.

❓ **I cannot select a phone contact via speech recognition. What am I doing wrong?**

❗ The Infotainment system accesses the phone book entries as they are stored. If the sorting order is set to "last name, first name", the correct command for calling John Smith is "Smith, John".

Detailed description ⇨ 55.

❓ **I cannot enter an address located in another country via speech recognition. What am I doing wrong?**

❗ Via speech recognition, you can only enter addresses for destinations located in the country whose language is selected as system language, e.g. if the system is set to German, you cannot enter a destination located in France.

Detailed description ⇨ 55.



## Phone

### ② How can I pair my phone with the Infotainment system?

- ① In order to pair a phone, press , select **Phone Settings** and then **Bluetooth**. Select **Pair device** and follow the instruction on the Infotainment system and your mobile phone. Make sure Bluetooth is enabled.

Detailed description ⇨ 65.

### ② How can I access my phone book or recent calls list via the Infotainment system?

- ① Depending on the phone, you must allow access to the respective data in the settings of your mobile phone. In general, the download of the phone book and recent calls list is not supported by all mobile phones.

Detailed description ⇨ 65.

### ② Although access to my phone book has been granted, not all contacts are available in the Infotainment system. Why is that?

- ① Depending on the phone, contacts stored on the SIM card cannot be read by the Infotainment system.

Detailed description ⇨ 65.

## Navigation

### ② How can I toggle between total driving time or remaining driving time and total distance or partial distance?

- ① When the navigation application is active, press the multifunction knob to display the **Navigation Menu**. Select **Switch Route Time/Destination** and adjust the settings as desired.

Detailed description ⇨ 38.

### ② When pressing DEST/NAV, different menus are displayed sometimes. Why is that?

- ① If route guidance is active, the destination application is displayed for you to select a destination.

Detailed description ⇨ 42.

If route guidance is not active, the **Route Menu** is displayed.

Detailed description ⇨ 50.

## Audio

### ② When playing media files from a device connected via Bluetooth, the track title and artist are not displayed in the Infotainment system and the media browse function is not available. Why is that?

- ① When connecting a device via Bluetooth, due to the Bluetooth protocol supported only restricted functions are available.

Detailed description ⇨ 34.

② **The Infotainment system does not have a tone button on the faceplate. How can I change the tone settings?**

① The tone settings menu is accessible via the **Home Page**. Press  and then select **More** to display the second **Home Page**. To access the tone settings menu, select **Tone**.

Detailed description ⇨ 19.



# Index

<b>A</b>		<b>C</b>	
Activating AUX.....	34	Category list.....	24
Activating Bluetooth music.....	34	CD player.....	30
Activating CD player.....	31	Chime volume.....	20
Activating radio.....	24	Control elements	
Activating the Infotainment system	14	Infotainment system.....	8
Activating the navigation system .	38	Steering wheel.....	8
Activating the phone portal.....	67	Control elements overview.....	8
Activating USB audio.....	34		
Activating USB picture.....	35	<b>D</b>	
Address book.....	42	DAB.....	28
Audio CUE volume.....	20	Date.....	21
Audio files.....	32	Destination input .....	42
Autostore lists.....	25	Digital audio broadcasting.....	28
Retrieving stations.....	25	Display.....	21
Storing stations.....	25	Displaying pictures.....	35
Auto volume.....	20		
AUX.....	32	<b>E</b>	
		Emergency call.....	66
<b>B</b>		EQ.....	19
BACK button.....	16	Equaliser.....	19
Balance.....	19		
Basic operation.....	16	<b>F</b>	
Bass.....	19	Factory defaults.....	21
Bluetooth connection.....	65	Fader.....	19
Bluetooth music.....	32	Favourite lists.....	26
Bread crumbs.....	50	Retrieving stations.....	26
		Storing stations.....	26
		File formats.....	30

Audio files.....	32
Picture files.....	32
Frequently asked questions.....	72

**G**

General information 30, 32, 37, 55, 64	
AUX.....	32
Bluetooth music.....	32
CD.....	30
Infotainment system.....	6
Navigation.....	37
Phone portal.....	64
Radio.....	24
USB.....	32
Gracenote.....	32
Guidance .....	50

**H**

Home address.....	42
Home Page.....	16, 21

**I**

Infotainment control panel.....	8
---------------------------------	---

**K**

Keyboard.....	42
---------------	----

**L**

Language.....	21
---------------	----

**M**

Maps.....	38
Maximum startup volume.....	20
Menu operation.....	16
Messages.....	16
Midrange.....	19
Mobile phones and CB radio equipment .....	70
Multifunction knob.....	16
Mute.....	14

**N**

## Navigation

Address book.....	42
Bread crumbs.....	50
Coordinates.....	42
Current location.....	38
Destination input.....	42
Favourite routes.....	42
General settings.....	38
Guidance alerts.....	50
Home address.....	42
Keyboard.....	42
Map display.....	38
Map manipulation.....	38
POIs.....	42
Recent destinations.....	42
Route guidance.....	50
Route options.....	50

Route simulation.....	38
Route tracking.....	50
TMC stations.....	50
Traffic incidents.....	50
Turn list.....	50
Voice prompts.....	50
Waypoint trip.....	42
Navigation system.....	37
Navigation volume.....	20

**O**

Operation.....	67
AUX.....	34
Bluetooth music.....	34
CD.....	31
Infotainment system.....	14
Menu.....	16
Navigation system.....	38
Phone.....	67
Radio.....	24
USB.....	34, 35

**P**

Pairing.....	65
Phone	
Bluetooth.....	64
Bluetooth connection.....	65
Conference call.....	67
Emergency calls.....	66
Functions during a call.....	67

Phone book.....	67	Radio data system (RDS) .....	27	Traffic programme.....	27
Recent calls.....	67	Regionalisation.....	27	Treble.....	19
Phone book.....	42, 67	Route guidance.....	50	Turn list.....	50
Phone call		Route simulation.....	38		
Initiating.....	67	<b>S</b>		<b>U</b>	
Taking.....	67	Software update.....	21	Usage.....	14, 24, 31, 38, 56
Picture files.....	32	Speech commands overview.....	59	AUX.....	34
Pictures.....	35	Speech recognition.....	55	Bluetooth music.....	34
Playing audio.....	34	Station list.....	24	CD.....	31
POIs.....	42	Station search.....	24	Infotainment system.....	14
<b>R</b>		Station search.....	24	Navigation system.....	38
Radio		Switching the Infotainment		Phone.....	67
Autostore lists.....	25	system on.....	14	USB.....	34, 35
Category list.....	24	System settings.....	21	USB.....	32
DAB.....	28	Display.....	21		
DAB announcements.....	28	Home Page.....	21	<b>V</b>	
Digital Audio Broadcasting.....	28	Language.....	21	Voice recognition.....	55
Favourite lists.....	26	Software.....	21	Volume	
Radio Data System.....	27	Time and Date.....	21	Audio Cue volume.....	20
RDS.....	27	<b>T</b>		Auto volume.....	20
RDS Options menu.....	27	TA.....	27	Chime volume.....	20
Regional.....	27	TA volume.....	20	Maximum startup volume.....	20
Retrieving stations.....	25, 26	Theft-deterrent feature .....	7	Mute function.....	14
Station list.....	24	Time.....	21	Navigation volume.....	20
Station search.....	24	Time format.....	21	Volume of traffic	
Storing stations.....	25, 26	TMC.....	50	announcements.....	20
TP.....	27	Tone settings.....	19	Volume settings.....	20
Traffic Programme.....	27	TP.....	27		
Waveband selection.....	24	Traffic incidents.....	50		

---

**W**

Waveband selection..... 24

Waypoint trip..... 42





---

## CD 400plus (1)/400/300

Introduction .....	82
Radio .....	98
CD Player .....	107
AUX input .....	110
USB port .....	111
Speech recognition .....	113
Phone .....	118
Index .....	130

## Introduction

General information .....	82
Theft-deterrent feature .....	83
Control elements overview .....	84
Usage .....	90
Basic operation .....	91
Tone settings .....	95
Volume settings .....	97

## General information

The Infotainment system provides you with state-of-the-art in-car infotainment.

For the AM, FM and DAB wavebands the radio is equipped with twelve automatically assignable channel presets. Furthermore, various channels can be allocated manually (waveband-independent).

The integrated audio player will entertain you with audio CDs and MP3/WMA CDs.

Furthermore, you can connect external data storage devices, e.g. iPod, MP3 player or USB stick, or a portable CD player to the Infotainment system as further audio sources.

The digital sound processor provides you with several preset equalizer modes for sound optimisation.

Optionally, the Infotainment system can be operated using controls on the steering wheel or via the speech recognition system.

In addition the Infotainment system can be equipped with a mobile phone portal.

The well-thought-out design of the control elements, the clear displays and a large multifunction knob enable you to control the system easily and intuitively.

### Note

This manual describes all options and features available for the various Infotainment systems. Certain descriptions, including those for display and menu functions, may not apply to your vehicle due to model variant, country specifications, special equipment or accessories.

## Display

The CD 400plus is available in two variants; noticeable difference is the display. The first variant has the following display.



### Important information on operation and traffic safety

#### **⚠ Warning**

The Infotainment system must be used so that the vehicle can be driven safely at all times. If in doubt, stop the vehicle and operate the Infotainment system while the vehicle is stationary.

### Radio reception

Radio reception may be disrupted by static, noise, distortion or loss of reception due to:

- changes in distance from the transmitter
- multi-path reception due to reflection
- shadowing

### Theft-deterrent feature



The Infotainment system is equipped with an electronic security system for the purpose of theft-deterrence.

The Infotainment system therefore functions only in your vehicle and is worthless to a thief.

## Control elements overview

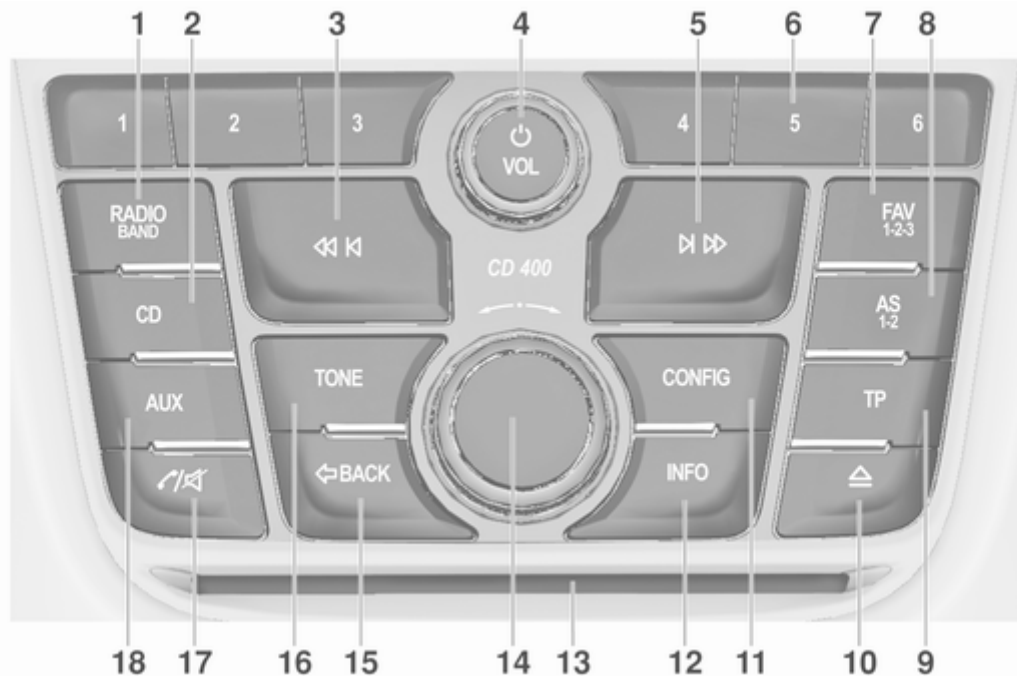
CD 400 / CD 400plus





<b>1 RADIO</b> ..... 98	<b>7 FAV (1/2/3)</b> ..... 99	<b>12 INFO</b> ..... 84
Activate radio or change waveband ..... 98	Lists of favourites (preset radio stations) ..... 99	Radio: information on the currently played station ..... 98
<b>2 CD</b> ..... 107	<b>8 AS (1/2)</b> ..... 99	CD/MP3/WMA: information on the currently inserted CD ..... 108
Start CD/MP3/WMA playback ..... 108	Automatic memory levels (preset radio stations) ..... 99	<b>13 CD slot</b> ..... 108
<b>3 Search backward</b> ..... 98	Short press: select autostore list ..... 99	<b>14 Multifunction knob</b> ..... 91
Radio: search backward ..... 98	Long press: save stations automatically ..... 99	Turn: mark menu options or set numeric values ..... 91
CD/MP3/WMA: skip track backward ..... 108	<b>9 TP</b> ..... 103	Press: select/activate the marked option; confirm set value; switch function on/off .. 91
<b>4 </b> ..... 90	Activate or deactivate radio traffic service ..... 103	<b>15 BACK</b> ..... 91
Press: switch on/off ..... 90	If Infotainment system is switched off: display time and date ..... 103	Menu: one level back ..... 91
Infotainment system ..... 90	<b>10 CD ejection</b> ..... 108	Input: delete last character or entire entry ..... 91
Turn: adjust volume ..... 90	<b>11 CONFIG</b> ..... 97	<b>16 TONE</b> ..... 95
<b>5 Search forward</b> ..... 98	Open settings menu ..... 97	Tone settings ..... 95
Radio: search forward ..... 98		<b>17  / </b> ..... 118
CD/MP3/WMA: skip track forward ..... 108		Open telephone main menu 124
<b>6 Radio station buttons 1...6</b> .... 99		Activate/deactivate mute ..... 90
Long press: save station ..... 99		
Short press: select station .... 99		

18	AUX .....	110
	Change to external audio source .....	110

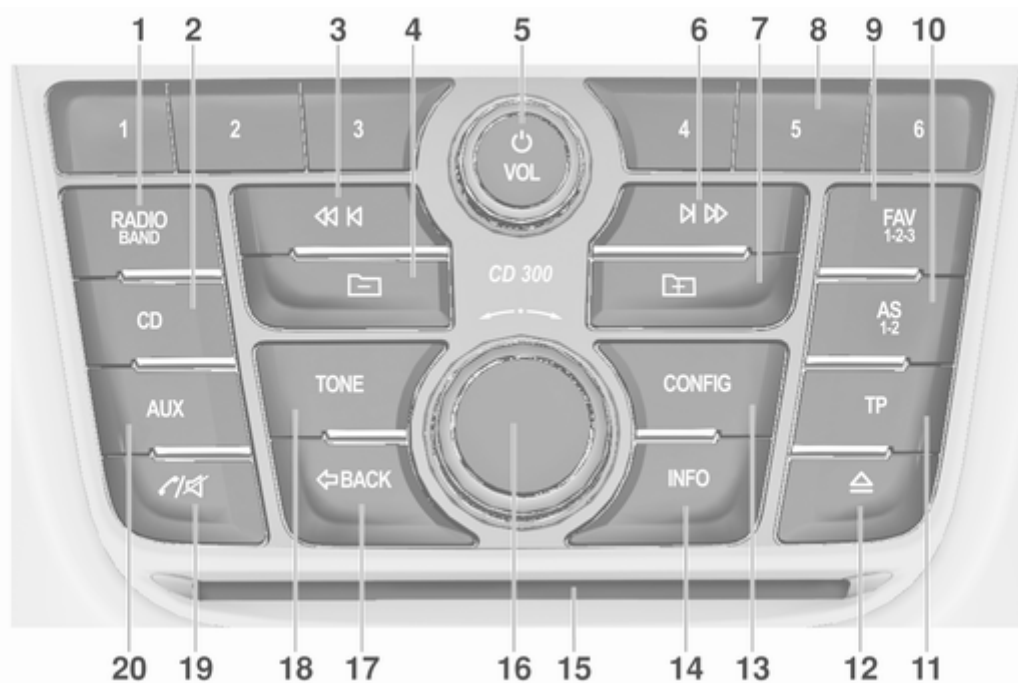
## CD 300





<b>1 RADIO</b> .....	98	<b>8</b> Radio station buttons 1...6 ....	99	<b>14 INFO</b> .....	84
Activate radio or change waveband .....	98	Long press: save station .....	99	Radio: information on the currently played station .....	98
<b>2 CD</b> .....	107	Short press: select station ....	99	CD/MP3/WMA: information on the currently inserted CD .....	108
Start CD/MP3/WMA playback .....	108	<b>9 FAV 1/2/3</b> .....	99	<b>15</b> CD slot .....	108
<b>3</b> Search backward .....	98	Lists of favourites (preset radio stations) .....	99	<b>16</b> Multifunction knob .....	91
Radio: search backward .....	98	<b>10 AS 1/2</b> .....	99	Turn: mark menu options or set numeric values .....	91
CD/MP3/WMA: skip track backward .....	108	Automatic memory levels (preset radio stations) .....	99	Press: select/activate the marked option; confirm set value; switch function on/off ..	91
<b>4</b> MP3: folder level higher .....	108	Short press: select autostore list .....	99	<b>17 BACK</b> .....	91
<b>5</b>  .....	90	Long press: save stations automatically .....	99	Menu: one level back .....	91
Press: switch on/off the Infotainment system .....	90	<b>11 TP</b> .....	103	Input: delete last character or entire entry .....	91
Turn: adjust volume .....	90	Activate or deactivate radio traffic service .....	103	<b>18 TONE</b> .....	95
<b>6</b> Search forward .....	98	If Infotainment system is switched off: display time and date .....	103	Tone settings .....	95
Radio: search forward .....	98	<b>12</b> CD ejection .....	108	<b>19</b>  /  .....	118
CD/MP3/WMA: skip track forward .....	108	<b>13 CONFIG</b> .....	97	Open telephone main menu	124
<b>7</b> MP3: folder level lower .....	108	Open settings menu .....	97	Activate/deactivate mute .....	90

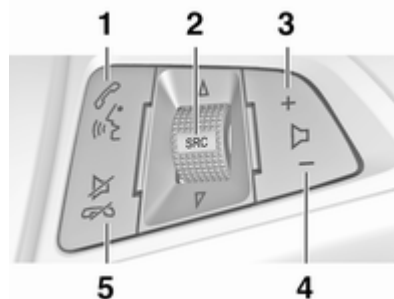

20	AUX .....	110
	Change to external audio source .....	110

### Steering wheel audio controls



- 1**    
 Short press: take phone call 118  
 or dial number in call list ..... 124  
 or activate speech  
 recognition (if available) ..... 113  
 Long press: show call list .... 124  
 or deactivate speech  
 recognition (if available) ..... 113
- 2** **SRC** (Source) ..... 90  
 Press: select audio source .... 90

- With radio active: turn  
 upwards/downwards to  
 select next/previous  
 preset radio station ..... 98
- With CD player active: turn  
 upwards/downwards to  
 select next/previous CD/  
 MP3/WMA track ..... 108
- With Phone portal active:  
 turn upwards/downwards  
 to select next/previous  
 entry in call list ..... 124
- With Phone portal active  
 and calls waiting: turn  
 upwards/downwards to  
 switch between calls ..... 124
- 3** +  
 Increase volume ..... 90
- 4** -  
 Reduce volume ..... 90
- 5**    
 Short press: end/decline  
 call ..... 124  
 or close call list ..... 124

or activate/deactivate mute ... 90

or deactivate speech  
recognition (if available) ..... 113

## Usage

### Control elements

The Infotainment system is operated via function buttons, multifunctional knobs and menus that are shown on the display.

Inputs are made optionally via:

- the central control unit in the instrument panel ↪ 84
- controls on the steering wheel ↪ 84
- the speech recognition system ↪ 113

### Switching the Infotainment system on or off

Press  briefly. After switching on, the last selected Infotainment source is active.

### Automatic switch-off

If the Infotainment system has been switched on using  when the ignition was switched off, it will switch off again automatically after 30 minutes.

## Setting the volume

Turn . The current setting is shown on the display.

When the Infotainment system is switched on, the last selected volume is set, provided that volume is lower than the maximum start-up volume.



The following can be set separately:



- the maximum start-up volume ↪ 97
- the volume of the traffic announcements ↪ 97

### Speed compensated volume

When speed compensated volume is activated ↪ 97 the volume is adapted automatically to make up for the road and wind noise as you drive.

### Mute

Press  /  (if Phone portal is available: press for a few seconds) to mute the audio sources.

To cancel mute again: turn  or press  /  again (if Phone portal is available: press for a few seconds).

### Volume limitation at high temperatures

At very high temperatures inside the vehicle the Infotainment system limits the maximum adjustable volume. If necessary the volume is decreased automatically.

### Modes of operation

#### Radio

Press **RADIO** to open the radio main menu or to change between the different wavebands.

Press the multifunction knob to open a submenu with options for station selection.

Detailed description of the radio functions ⇨ 98.

#### Audio players



Press **CD** or **AUX** to open the CD, USB, iPod or AUX menus or to switch between these menus.

Press the multifunction knob to open a submenu with options for track selection.

Detailed description of:

- CD player functions ⇨ 108
- AUX input functions ⇨ 110
- USB port functions ⇨ 111

#### Phone

Press  /  to open the telephone menu.

Press the multifunction knob to open a submenu with options for the input or selection of numbers.

Detailed description of the mobile phone portal functions ⇨ 118.

### Basic operation

#### Multifunction knob

The multifunction knob is the central control element for the menus.

Turn the multifunction knob:

- CD 400 / CD 400plus: to mark a menu option
- CD 300: to display a menu option
- to set a numeric value

Press the multifunction knob:

- CD 400 / CD 400plus: to select or activate the marked option
- CD 300: to select or activate the option displayed
- to confirm a set value
- to switch a system function on/off

#### BACK button

Press **BACK** briefly:

- to exit a menu
- to return from a submenu to the next higher menu level
- to delete the last character in a character sequence

Press and hold **BACK** for a few seconds to delete the entire entry.

## Examples of menu operation

CD 400 / CD 400plus  
Selecting an option

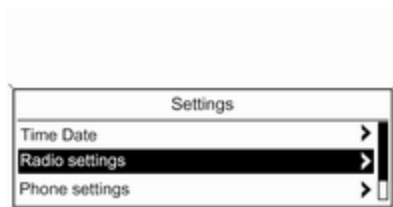

Turn the multifunction knob to move the cursor (= coloured background) to the desired option.

Press the multifunction knob to select the marked option.

### Submenus

An arrow on the right-hand edge of the menu indicates that after selection of the option a submenu with further options will be opened.

## Activating a setting

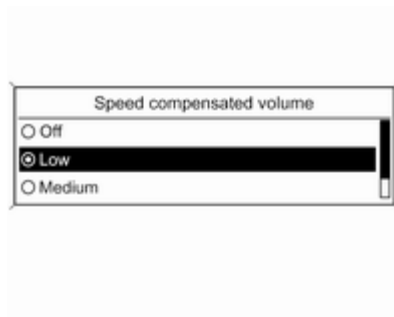

Turn the multifunction knob to mark the desired setting.

Press the multifunction knob to activate the setting.

## Setting a value

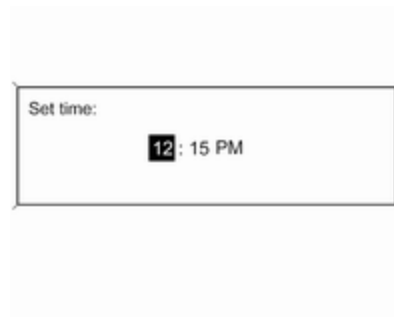

Turn the multifunction knob to change the current value of the setting.

Press the multifunction knob to confirm the set value.

## Switching a function on or off



Turn the multifunction knob to mark the function to be switched on or off. Press the multifunction knob to switch between the settings **On** and **Off**.

## Entering a character sequence

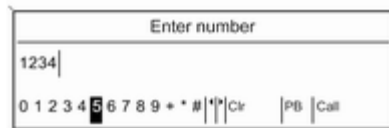

For the input of character sequences, e.g. telephone numbers:

Turn the multifunction knob to select the desired character.

Press the multifunction knob to confirm the selected character.

To delete the last character in the character sequence, press **BACK**.

## CD 300

## Menu elements and symbols

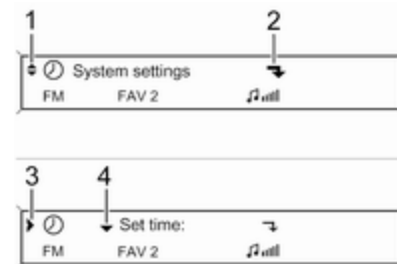

The up and down arrows **1** indicate: the top menu level is active. Further options are available in the active menu.

Turn the multifunction knob to display the other options in the active menu.

The angled arrow **2** indicates: a submenu with further options is available.

Press the multifunction knob to select the option displayed and to open the corresponding submenu.

The arrow pointing to the right **3** indicates: the first submenu level is active (two arrows = second submenu level active).

The down arrow **4** indicates: further options are available in the active submenu.

### Activating a setting

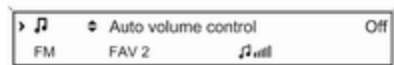

Press the multifunction knob to open the corresponding settings menu.

Turn the multifunction knob to display the desired setting.

Press the multifunction knob to activate the setting.

### Setting a value

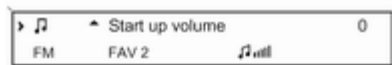

Press the multifunction knob to open the corresponding settings menu.

Turn the multifunction knob to change the current value of the setting.

Press the multifunction knob to confirm the set value.

### Switching a function on or off



Press the multifunction knob to open the corresponding settings menu.

Turn the multifunction knob to mark the setting **On** or **Off**.

Press the multifunction knob to confirm the marked setting.

## Entering a character sequence



Press the multifunction knob to open the relevant settings menu.

Turn the multifunction knob to change the character at the current cursor position.

Press the multifunction knob to confirm the character displayed.

To delete the last character in the character sequence, press **BACK**.

## Tone settings

In the tone settings menu the tone characteristics can be set for each radio waveband and each audio player source.



Press **TONE** to open the tone menu.

## Setting bass, middle and treble

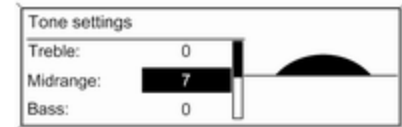

Select **Bass**, **Midrange**: or **Treble**:

Set the desired value for the selected option.

### Setting the volume distribution between front - rear

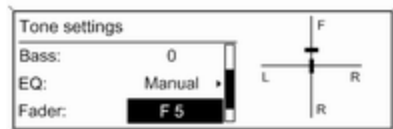

Select **Fader**.  
Set the desired value.

### Setting the volume distribution between right - left

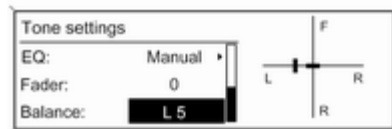

Select **Balance**.  
Set the desired value.

### Setting an individual setting to "0"

Select the desired option and press and hold the multifunction knob for a few seconds.

### Setting all settings to "0" or "Off"

Press and hold **TONE** for a few seconds.

### Optimizing the tone for the style of music

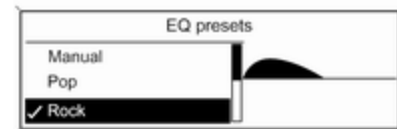

Select **EQ**: (Equalizer).  
The displayed options offer optimized bass, middle and treble presettings for the relevant style of music.  
Select the desired option.



## Volume settings

### Maximum startup volume

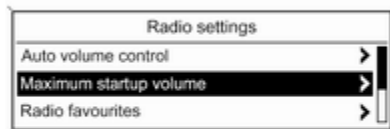

Press **CONFIG** to open the system settings menu.

CD 400 / CD 400plus: select **Radio settings** and then **Maximum startup volume**.

CD 300: select **Audio settings** and then **Start up volume**.

Set the desired value.

### Speed compensated volume

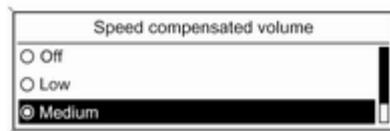

Press **CONFIG** to open the system settings menu.

CD 400 / CD 400plus: select **Radio settings** and then **Auto volume control**.

CD 300: select **Audio settings** and then **Auto volume control**.

Speed compensated volume can be deactivated or the degree of volume adaptation can be selected in the menu displayed.

Select the desired option.

### Volume of the traffic announcements (TA)

The volume of the traffic announcements can be increased or reduced proportionate to the normal audio volume.

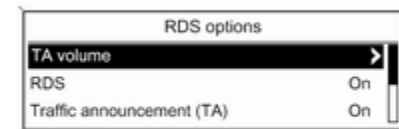

Press **CONFIG** to open the system settings menu.

CD 400 / CD 400plus: select **Radio settings**, **RDS options** and **TA volume**.

CD 300: select **Audio settings**, **RDS options** and **TA volume**.

Set the desired value for the volume increase or reduction.

## Radio

Usage .....	98
Station search .....	98
Autostore lists .....	99
Favourite lists .....	99
Waveband menus .....	100
Radio data system (RDS) .....	103
Digital audio broadcasting .....	105

## Usage

### Activating the radio

Press **RADIO** to open the radio main menu.

The station last played will be received.

### Selecting the waveband

Press **RADIO** once or several times to select the desired waveband.

The station last played in that waveband will be received.

## Station search

### Automatic station search

Briefly press **◀ K** or **M ▶** to play the next station in the station memory.

### Manual station search

Press **◀ K** or **M ▶** for a few seconds to start a search for the next receivable station in the current waveband.

When the required frequency has been reached the station is played automatically.

### Note

Manual station search: If the radio does not find a station, it switches automatically to a more sensitive search level. If it still does not find a station, the frequency that was last active is set again.

### Note

FM waveband: when the RDS function is activated, only RDS stations ⇨ 103 are searched for, and when the radio traffic service (TP) is activated, only traffic service stations ⇨ 103 are searched for.

## Manual station tuning

### AM waveband

Turn the multifunction knob and set the optimal reception frequency on the pop-up frequency display.

### DAB waveband

Press the multifunction knob to open the DAB menu and select **DAB manual tuning**.

Turn the multifunction knob and set the required reception frequency on the pop-up frequency display.

## Autostore lists

The stations that can be received best in a waveband can be searched for and stored automatically via the autostore function.

AS-Stations		FM AS1	
1 FM 89.0	Q1)	2 FM 92.1	
3 FM 93.8		4 FM 95.6	
5 FM 95.9		6 FM 97.2	

### Note

The currently received station is marked by .

Each waveband has 2 autostore lists (**AS 1**, **AS 2**), in each of which 6 stations can be stored.

## Automatic station storing

Press and hold **AS** until an autostore message is displayed. The 12 strongest stations in the current waveband will be stored in the 2 autostore lists.

To abort the autostore procedure, press the multifunction knob.

## Storing stations manually

Stations can also be stored manually in the autostore lists.

Set the station to be stored.

Briefly press **AS** to open an autostore list or to switch to another autostore list.

To store the station in a list position: press the corresponding station button 1...6 until a confirmation message is displayed.

### Note

Manually stored stations are overwritten in an automatic station storing process.

## Retrieving a station

Briefly press **AS** to open an autostore list or to switch to another autostore list.

Briefly press one of the station buttons 1...6, to open the station at the corresponding list position.

## Favourite lists

Stations of all wavebands can be stored manually in the favourite lists.

FAV page 1 of 6		FAV 1	
1 FM 102.3	Q1)	2 FM 96.8	
3 FM 89.0		4 FM 93.1	
5 FM 105.8		6 FM 103.9	

6 stations can be stored in each favourite list.

The number of available favourite lists is configurable (see below).

#### Note

The currently received station is marked by .

### Storing a station

Set the station to be stored.

Briefly press **FAV** to open a favourite list or to switch to another favourite list.

To store the station in a list position: press the corresponding station button 1...6 until a confirmation message is displayed.

### Retrieving a station

Briefly press **FAV** to open a favourite list or to switch to another favourite list.

Briefly press one of the station buttons 1...6, to open the station at the related list position.

### Defining the number of available favourite lists

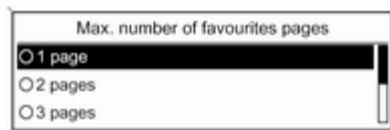

Press **CONFIG**.

Select **Radio settings** and then **Radio favourites**.

Select the desired number of available favourite lists.

### Waveband menus

Alternative facilities for station selection are available via waveband-specific menus.

With the radio main menu active, press the multifunction knob to open the relevant waveband menu.

#### Note

The following FM-specific displays are shown as examples.

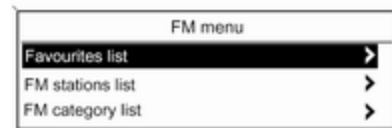

### Favourites list

Select **Favourites list**. All stations saved in the favourites lists are displayed.

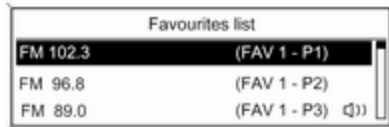

Select the required station.

#### Note

The currently received station is marked by .

## Stations lists

### AM/FM waveband

Select **AM stations list** or **FM stations list**.

All receivable AM/FM stations in the current reception area are displayed.

### DAB waveband

Turn the multifunction knob.

All receivable DAB stations  $\diamond$  105 in the current reception area are displayed.

#### Note

If no station list has been created beforehand, the Infotainment system performs an automatic station search.

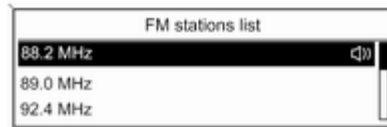

Select the required station.

#### Note

The currently received station is marked by .

## Updating stations lists

If the stations stored in a waveband-specific station list can no longer be received:

Select the corresponding command to update a station list.

CD 400plus: The dual tuner of the Infotainment system continuously updates the FM stations list in the background. No manual update is required.

A station search is started. Once the search is completed the station last received will be played.

To abort the station search, press the multifunction knob.

#### Note

If a waveband-specific station list is updated, the corresponding category list is also updated.

## Category lists

Numerous RDS stations  $\diamond$  103 broadcast a PTY code, which specifies the type of programme transmitted (e.g. news). Some

stations also change the PTY code depending on the content currently being transmitted.

The Infotainment system stores these stations, sorted by programme type, in the corresponding category list.

To search for a programme type determined by station: select the waveband specific category list option.



A list of programme types currently available is displayed.

Select the desired programme type.

CD 400 / CD 400plus: A list of stations is displayed that transmit a programme of the selected type.



Select the desired station.

CD 300: The next receivable station of the selected type is searched for and is played.

The category list is also updated when the corresponding waveband specific station list is updated.

#### Note

The currently received station is marked by .

## DAB announcements

Besides their music programmes numerous DAB stations ⇨ 105 broadcast various announcement categories.

The currently received DAB service (programme) is interrupted when any announcements of previously activated categories are pending.

### Activating announcement categories

Select **DAB announcements** in the DAB menu.

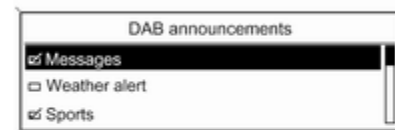

Activate the desired announcement categories.

Several announcement categories can be selected at the same time.

#### Note

DAB announcements can only be received if the DAB waveband is activated.

## Radio data system (RDS)

RDS is a service of FM stations that considerably facilitates the finding of the desired station and its fault-free reception.



## Advantages of RDS

- On the display the programme name of the set station appears instead of its frequency.
- During a station search the Infotainment system tunes in to RDS stations only.
- The Infotainment system always tunes into the best receivable broadcasting frequency of the set station by means of AF (Alternative Frequency).
- Depending on the station that is received, the Infotainment system displays radio text that can contain, e.g., information about the current programme.

## Configuring RDS

To open the menu for the RDS configuration:

Press **CONFIG**.

CD 400 / CD 400plus: Select **Radio settings** and then **RDS options**.

CD 300: Select **Audio settings** and then **RDS options**.

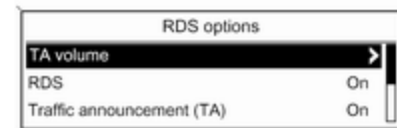

## TA volume

The volume of the traffic announcements (TA) can be preset  $\varnothing$  97.

## Switching RDS on and off

Set RDS to **On** or **Off**.

#### Note

If RDS is switched off, it will be automatically switched on again when a radio station is changed (by search function or preset button).

## Traffic announcement (TA)

To switch the TA function on or off permanently:

Set **Traffic announcement (TA)** to **On** or **Off**.

**Switching regionalization on and off** (RDS must be activated for regionalization)

At certain times some RDS stations broadcast regionally different programmes on different frequencies.

Set **Regional (REG)** to **On** or **Off**.

If regionalization is switched on, only alternative frequencies (AF) with the same regional programmes are selected.

If regionalization is switched off, alternative frequencies of the stations are selected without regard to regional programmes.

### **RDS-scrolling text**

Some RDS stations hide the programme name in the display line in order to display additional information.

To prevent additional information being displayed:

Set **Text scroll freeze** to **On**.

### **Radio text:**

If RDS and reception of an RDS station are activated, information about the programme that is currently receivable and about the music track currently playing are displayed below the programme name.

To show or hide the information:

Set **Radio text:** to **On** or **Off**.

### **Radio traffic service**

(TP = Traffic Programme)

Radio traffic service stations are RDS stations that broadcast traffic news.

### **Switching the radio traffic service on and off**

To switch the traffic announcement standby facility of the Infotainment system on and off:

Press **TP**.

- If the radio traffic service is switched on, [ ] is displayed in the radio main menu.
- Only radio traffic service stations are received.

- If the current station is not a radio traffic service station, a search is started automatically for the next radio traffic service station.
- If a radio traffic service station has been found, [TP] is displayed in the radio main menu.
- Traffic announcements are played at the preset TA volume ⇨ 97.
- If the radio traffic service is switched on, CD/MP3 playback is interrupted for the duration of the traffic announcement.

### **Listening to traffic announcements only**

Switch on the radio traffic service and completely turn down the volume of the Infotainment system.

### **Blocking out traffic announcements**

To block out a traffic announcement, e.g. during CD/MP3 playback:

Press **TP** or the multifunction knob to confirm the cancel message on the display.



The traffic announcement is aborted, but the radio traffic service remains switched on.

### EON (Enhanced Other Networks)

With EON you can listen to radio traffic announcements even if the station you have set does not broadcast its own radio traffic service. If such a station is set, it is displayed in black as for radio traffic service stations **TP**.

## Digital audio broadcasting

Digital audio broadcasting (DAB) is an innovative and universal broadcast system.

DAB stations are indicated by the programme name instead of the broadcasting frequency.



### General information

- With DAB, several radio programmes (services) can be broadcast on a single frequency (ensemble).
- Besides high-quality digital audio services, DAB is also able to transmit programme-associated data and a multitude of other data services including travel and traffic information.
- As long as a given DAB receiver can pick up the signal sent out by a broadcasting station (even if the signal is very weak), sound reproduction is ensured.

- There is no fading (weakening of the sound) that is typical of AM or FM reception. The DAB signal is reproduced at a constant volume.
- If the DAB signal is too weak to be picked up by the receiver, reception is interrupted completely. This incident can be avoided by activating **Auto ensemble linking** and/or **Auto linking DAB-FM** in the DAB settings menu.
- Interference caused by stations that are on nearby frequencies (a phenomenon that is typical of AM and FM reception) does not occur with DAB.
- If the DAB signal is reflected by natural obstacles or buildings, the reception quality of DAB is improved, whereas AM or FM reception is considerably impaired in such cases.
- When DAB reception is enabled, the FM tuner of the Infotainment system remains active in the background and continually searches for the best receivable FM stations. If TP ⇨ 103 is activated,

traffic announcements of the FM station which is currently best receivable are issued. Deactivate TP, if you do not wish DAB reception to be interrupted by FM traffic announcements.

## Configuring DAB

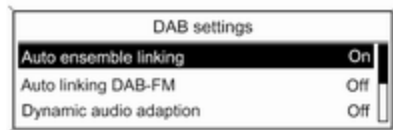

Press **CONFIG**.

Select **Radio settings** and then **DAB settings**.

The following options are available in the configuration menu:

- **Auto ensemble linking:** with this function activated, the device switches over to the same service (programme) on another DAB ensemble (frequency, if available) when the DAB signal is too weak to be picked up by the receiver.
- **Auto linking DAB-FM:** with this function activated, the device switches over to a corresponding FM station of the active DAB service (if available) when the DAB signal is too weak to be picked up by the receiver.
- **Dynamic audio adaption:** with this function activated, the dynamic range of the DAB signal is reduced. That means the level of the loud sounds is reduced, but not the level of the quiet sounds. Therefore the volume of the Infotainment system

can be raised to a point where the quiet sounds are audible, without the loud sounds being too loud.

- **Frequency band:** after selection of this option it can be defined which DAB wavebands are to be received by the Infotainment system.

## CD Player

General information .....	107
Usage .....	108

### General information

The Infotainment system's CD player can play audio CDs and MP3/WMA CDs.

### Important information about audio CDs and MP3/WMA CDs

#### Caution

Under no circumstances place DVDs, single-CDs with a diameter of 8 cm or shaped CDs in the audio player.

You must not put any stickers on CDs. These discs can get jammed in the CD drive and ruin the player. Replacement of the device will then be necessary.

- The following CD formats can be used:
  - CD-ROM Mode 1 and Mode 2
  - CD-ROM XA Mode 2, Form 1 and Form 2
- The following file formats can be used:

ISO9660 Level 1, Level 2, (Romeo, Joliet)

MP3 and WMA files written in any format other than listed above may not play correctly, and their file names and folder names may not be displayed correctly.

#### Note

ISO 13346 is not supported. It may be required to manually select ISO 9660 when burning an audio CD, e.g. with Windows 7.

- Audio CDs with copy protection, which are not in compliance with the audio CD standard, may not play correctly or not at all.
- Self-recorded CD-Rs and CD-RWs are more vulnerable to mishandling than prerecorded CDs. Correct handling, especially in the case of self-recorded CD-Rs and CD-RWs, must be ensured. See below.
- Self-recorded CD-Rs and CD-RWs may not play correctly or not at all. In such cases it is not the equipment that is at fault.

- On mixed mode CDs (audio tracks and compressed files, e.g. MP3, are stored), the audio tracks part and the compressed files part can be played separately.
- Avoid leaving fingerprints when you change CDs.
- Put CDs back in their sleeves immediately after removing them from the CD player in order to protect them from damage and dirt.
- Dirt and liquids on CDs can smear the lens of the CD player inside the device and cause faults.
- Protect CDs from heat and direct sunlight.
- The following restrictions apply for the data stored on an MP3/WMA CD:
  - Number of tracks: max. 999
  - Number of folders: max. 255
  - Folder structure depth: max. 64 levels (recommended: max. 8 levels)
  - Number of playlists: max. 15

Number of songs per playlist: max. 255

Applicable playlist extensions: .m3u, .pls, .asx, .wpl

- This chapter deals only with playing MP3 files since the operation for MP3 and WMA files is identical. When a CD with WMA files is loaded MP3 related menus are displayed.

## Usage

### Starting CD playback



Press **CD** to open the CD or MP3 menu.

If there is a CD in the CD player, CD playback is started.

Depending on the data stored on the audio CD or MP3 CD differing information about the CD and the current music track will be shown on the display.

### Inserting a CD

Insert a CD with the printed side facing up into the CD slot until it is drawn in.

#### Note

If a CD is inserted, a CD symbol is shown in the top line of the display.

### Changing the standard page view

(only with CD 300)

During audio CD or MP3 playback: press the multifunction knob and then select **Default CD page view** or **Default MP3 page view**.

Select the desired option.

### Changing the folder level

Press  $\leftarrow$  or  $\rightarrow$  to change to a higher or lower folder level.

### Skipping to the next track or previous track

Briefly press  $\ll$   $\ll$  or  $\gg$   $\gg$ .

### Fast forward or rewind

Press and hold  $\ll$   $\ll$  or  $\gg$   $\gg$  to fast forward or rewind the current track.

### Selecting tracks using the audio CD or MP3 menu

During audio CD playback

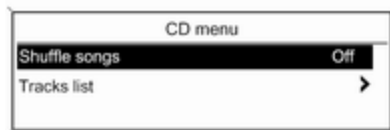

Press the multifunction knob to open the audio CD related menu.

To play all tracks in random order: set **Shuffle songs** to **On**.

To select a track on the audio CD: select **Tracks list** and then select the desired track.

### During MP3 playback

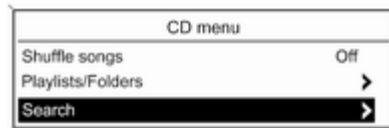

Press the multifunction knob to open the MP3 related menu.

To play all tracks in random order: set **Shuffle songs** to **On**.

To select a track from a folder or playlist: select **Playlists/Folders**.

Select a folder or playlist and then select the desired track.

#### Note

If a CD contains both audio and MP3 data, the audio data can be selected from **Playlists/Folders**.

To open a menu with additional options for track search and selection: select **Search**. The options available depend on the data saved on the MP3 CD.

The search process on the MP3 CD may take several minutes. During this time the station last played will be received.

### Removing a CD

Press  $\triangle$ .

The CD is pushed out of the CD slot.

If the CD is not removed after ejection, it will be drawn back in again automatically after a few seconds.

## AUX input

General information .....	110
Usage .....	110

### General information

In the centre console there is an AUX socket for the connection of external audio sources.

It is possible, for example, to connect a portable CD player with a 3.5 mm jack plug to the AUX input.

#### Note

The socket must always be kept clean and dry.

### Usage

Press **AUX** once or several times to activate the AUX mode.



An audio source that is connected to the AUX input can be operated only via the control elements of the audio source.

## USB port

General information .....	111
Playing saved audio files .....	111

### General information

In the centre console there is a USB socket for the connection of external audio data sources.

Devices connected to the USB port are operated via the controls and menus of the Infotainment system.

#### Note

The socket must always be kept clean and dry.

### Important information

The following devices can be connected to the USB port:

- iPod
- Zune
- PlaysForSure device (PFD)
- USB drive

#### Note

Not all iPod, Zune, PFD or USB drive models are supported by the Infotainment system.

### Playing saved audio files

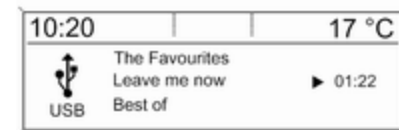

Press **AUX** once or several times to activate the USB mode.

Playback of the audio data stored on the USB device is started.

The operation of data sources connected via USB is generally the same as for an audio MP3 CD ↻ 108.

On the following pages only the aspects of operation that are different/additional are described.

Operation and the screen displays are described for USB drives only. Operation of other devices, e.g. iPod or Zune is generally the same.

### Selecting tracks using the USB menu

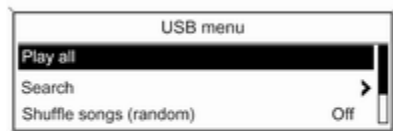

Press the multifunction knob to open the USB related menu.

To play all tracks in succession: select **Play all**.

To display a menu with various additional options for track search and selection: select **Search**.

The search process on the USB device may take several minutes. During this time the station last played will be received.

To play all tracks in random order: set **Shuffle songs (random)** to **On**.

To repeat the currently played track: set **Repeat** to **On**.



## Speech recognition

General information .....	113
Phone control .....	114

### General information

The speech recognition of the Infotainment system enables you to operate the phone portal via voice input. It recognises commands and numeric sequences independently of the current speaker. The commands and numeric sequences can be spoken without a voice pause between the individual words.

You can save telephone numbers assigning a name of your choice (voice tag). Using these names, you can later set up a telephone connection.



In the event of incorrect operation or commands, the speech recognition gives you visual and/or acoustic feedback and requests you to re-enter the desired command. Apart from this, the speech recognition acknowledges important commands and will enquire if necessary.

To ensure that conversations inside the vehicle do not lead to unintentional triggering of system

functions, the speech recognition does not start until it has been activated.

### Important notes on language support

- Not all languages available for the display of the Infotainment system are also available for the speech recognition.
- If the currently selected language for the display is not supported by the speech recognition, you must enter the voice commands in English.

To be able to enter voice commands in English, you must first activate the phone main menu by pressing  /  on the Infotainment system, and then activate the speech recognition of the phone portal by pressing  on the steering wheel.

## Phone control

### Activating speech recognition

To activate the speech recognition of the Phone portal, press  $\text{Ⓜ}$  on the steering wheel. For the duration of the dialogue any active audio source is muted and any traffic news fade-in is cancelled.

### Adjusting the volume for voice output

Turn the volume knob on the Infotainment system, or press + or – on the steering wheel.

### Cancelling a dialogue

There are various ways of deactivating the speech recognition and cancelling the dialogue:

- Press  $\text{Ⓜ}$  on the steering wheel.
- Say "Cancel".
- Do not enter (say) any commands for some time.
- After the third unrecognised command.

## Operation

With the aid of the speech recognition the mobile phone can be operated very conveniently via voice input. It is sufficient to activate the speech recognition and to enter (say) the desired command. After input of the command the Infotainment system guides you through the dialogue with appropriate questions and feedback to achieve the desired action.

### Main commands

After activation of the speech recognition a short tone signals that the speech recognition is expecting input.

Main commands available:

- "Dial"
- "Call"
- "Redialing"
- "Save"
- "Delete"
- "Directory"
- "Pair"

- "Select device"
- "Voice feedback"

### Commands that are frequently available

- "Help": the dialogue is terminated and all commands available within the actual function are enumerated.
- "Cancel": the speech recognition is deactivated.
- "Yes": a suitable action is triggered depending on the context.
- "No": a suitable action is triggered depending on the context.

### Entering a telephone number

After the command "Dial" the speech recognition requests input of a number.

The telephone number must be spoken in your normal voice without any artificial pauses between the individual numbers.

Recognition works best if a pause of at least half a second is made after every three to five digits. The Infotainment system then repeats the numbers recognised.

You can then enter further numbers or the following commands:

- **"Dial"**: the inputs are accepted.
- **"Delete"**: the number last entered or the block of numbers last entered is deleted.
- **"Plus"**: a preceding "+" is entered for a call abroad.
- **"Verify"**: the inputs are repeated by the voice output.
- **"Asterisk"**: an asterisk "\*" is entered.
- **"Hash"**: a hash "#" is entered.
- **"Help"**
- **"Cancel"**

The maximum length of the telephone number entered is 25 digits.

To be able to make a call abroad you can say the word "Plus" (+) at the beginning of your number. The plus allows you to call from any country without knowing the prefix for calls made abroad in that country. Then say the required country code.

#### Example of a dialogue

User: "Dial"

Voice output: **"Please, say the number to dial"**

User: **"Plus Four Nine"**

Voice output: **"Plus Four Nine"**

User: **"Seven Three One"**

Voice output: **"Seven Three One"**

User: **"One One Nine Nine"**

Voice output: **"One One Nine Nine"**

User: **"Dial"**

Voice output: **"The number is being dialled"**

#### Entering a name

Using the **"Call"** command a telephone number is entered that has been stored in the telephone book under a name (voice tag).

Commands available:

- **"Yes"**
- **"No"**
- **"Help"**
- **"Cancel"**

#### Example of a dialogue

User: "Call"

Voice output: **"Please, say the nametag to call"**

User: <Name>

Voice output: **"Do you want to call <Michael>?"**

User: **"Yes"**

Voice output: **"The number is being dialled"**

#### Starting a second call

A second call can be started during an active telephone call. To do so, press #£.

Commands available:

- **"Send"**: activate manual DTMF (touch-tone dialling), e.g. for voice mail or telephone banking.
- **"Send nametag"**: activate DTMF (touch-tone dialling) by entering a name (voice tag).
- **"Dial"**
- **"Call"**
- **"Redialing"**
- **"Help"**
- **"Cancel"**

**Example of a dialogue**

User: <if a telephone call is active:  
press ⓧ>

User: **"Send"**

Voice output: **"Please, say the number to send."**

(for number input see the dialogue example for **Entering a telephone number**)

User: **"Send"**

**Redialing**

The number last dialled is redialled with the command **"Redialing"**.

**Saving**

With the command **"Save"** a telephone number is stored in the telephone book under a name (voice tag).

The name entered must be repeated once. The pitch and pronunciation must be as identical as possible for both name inputs, otherwise the speech recognition will reject the inputs.

A maximum of 50 voice tags can be stored in the telephone book.

Voice tags are speaker-dependent, i.e. only the person who recorded a voice tag can open it.

To avoid the start of the recording of a saved name from being cut-off, a short pause should be left after an input request.

To be able to use the voice tag independently of the location, i.e. including other countries, all telephone numbers should be entered with a "plus" character and a country code.

Commands available:

- **"Save"**: the inputs are accepted.
- **"Verify"**: the last input is repeated.
- **"Help"**
- **"Cancel"**

**Example of a dialogue**

User: **"Save"**

Voice output: **"Please, say the number to save"**

(for number input see the dialogue example for **Entering a telephone number**)

User: **"Save"**

Voice output: **"Please, say the nametag to save"**

User: <Name>

Voice output: **"Please, repeat the nametag to confirm"**

User: <Name>

Voice output: **"Saving the nametag"**

**Deleting**

A previously saved voice tag is deleted with the command **"Delete"**.

Commands available:

- **"Yes"**
- **"No"**
- **"Help"**
- **"Cancel"**

**Listening to stored names**

The voice output of all stored names (voice tags) is started with the command **"Directory"**.

Commands available during voice output of the voice tags:

- **"Call"**: the telephone number of the voice tag last read aloud is selected.
- **"Delete"**: the entry of the voice tag last read aloud is deleted.

### Saving a mobile phone to or deleting it from the device list

With the command **"Pair"** a mobile phone can be saved to or deleted from the device list of the Phone portal ↗ 119.

Commands available:

- **"Add"**
- **"Delete"**
- **"Help"**
- **"Cancel"**

### Example of a dialogue

User: **"Pair"**

Voice output: **"Do you want to add or delete a device?"**

User: **"Add"**

Voice output: **"Using the pair function in the external device, enter <1234> to pair."**

Voice output: **"Do you want to pair the device?"**

User: **"Yes"**

Voice output: **"The device is connected as the number <device\_number>"**

### Selecting a mobile phone from the device list

Using the **"Select device"** command, a mobile phone can be selected in the device list for setting up a Bluetooth connection.

### Example of a dialogue

User: **"Select device"**

Voice output: **"Please, say a device number to select"**

User: **<device\_number>**

Voice output: **"Do you want to select the device number <device\_number>?"**

User: **"Yes"**

Voice output: **"Do you want to pair the device?"**

User: **"Yes"**

Voice output: **"One moment. The system searches for the selected device"**

Voice output: **"Device number <dev\_num> is selected"**

### Voice feedback

Each voice input is answered or commented on by the Infotainment system by way of a voice output that is adapted to the situation.

To switch the voice output on or off, enter **"Voice feedback"** or press **Ⓜ**.

## Phone

General information .....	118
Bluetooth connection .....	119
Emergency call .....	123
Operation .....	124
Mobile phones and CB radio equipment .....	127

### General information

The Phone portal provides you with the possibility of having mobile phone conversations via a vehicle microphone and the vehicle loudspeakers as well as operating the most important mobile phone functions via the Infotainment system in the vehicle. To be able to use the Phone portal, the mobile phone has to be connected with it via Bluetooth.

The Phone portal can be operated optionally via the speech recognition system.

Not all Phone portal functions are supported by every mobile phone. The possible phone functions depend on the relevant mobile phone and network provider. You will find further information on this in the operating instructions for your mobile phone or you can enquire about them with your network provider.

### Important information for operation and traffic safety

#### Warning

Mobile phones have effects on your environment. For this reason safety regulations and directions have been prepared. You should be familiar with the related directions before you use the telephone function.

#### Warning

Use of the hands-free facility while driving can be dangerous because your concentration is reduced when telephoning. Park your vehicle before you use the hands-free facility. Follow the stipulations of the country in which you find yourself at present.

Do not forget to follow the special regulations that apply in specific areas and always switch off the mobile phone if the use of mobile

phones is prohibited, if interference is caused by the mobile phone or if dangerous situations can occur.

## Bluetooth

The Phone portal is certified by the Bluetooth Special Interest Group (SIG).

You will find further information about the specification on the Internet at <http://www.bluetooth.com>

## Operating the speech recognition

Do not use the speech recognition in emergencies, because in stress situations your voice can change so much that it can no longer be recognised sufficiently to set up the desired connection quickly enough.

## Bluetooth connection

Bluetooth is a radio standard for the wireless connection of, e.g., a telephone with other devices. Information such as a telephone

book, call lists, the network operator's name and field strength can be transferred. The functionality can be restricted depending on the telephone type.

To be able to set up a Bluetooth connection with the Phone portal, the Bluetooth function of the mobile phone must be activated and the mobile phone must be set to "visible". For further information, please refer to the operating instructions for the mobile phone.

## Bluetooth menu

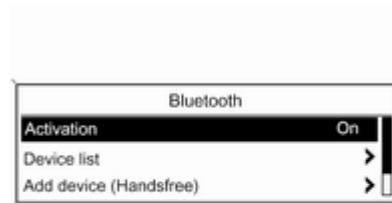

Press **CONFIG**.

Select **Phone settings** and then **Bluetooth**.

## Activating Bluetooth

If the Bluetooth function of the Phone portal is deactivated: set **Activation** to **On** and confirm the subsequent message.

## Device list

When a mobile phone is connected to the Phone portal via Bluetooth for the first time, the mobile phone is stored in the device list.

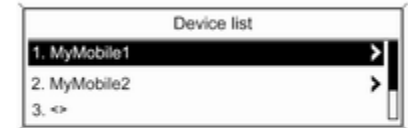

A maximum of 5 mobile phones can be stored in the device list.

## Connecting a mobile phone for the first time

There are two options for connecting a mobile phone to the Phone portal: by adding it as a handsfree device or by using the SIM Access Profile (SAP).

### Handsfree mode

When the mobile phone is added as a handsfree device, the user can make or receive calls and use other functions via the Phone portal. The range of functions available depends on the mobile phone. While it is connected with the Phone portal, the mobile phone can be operated as usual. Note that the mobile phone battery may discharge at a higher speed than usual due to the Bluetooth connection being active along with normal operation of the mobile phone.

### SAP mode

When using the SAP option, a wider range of functions is available via the Phone portal, e.g. various security and messaging options. The actual

range of functions depends on the network provider. Additionally, in SAP mode the mobile phone is in the standby mode. Only the Bluetooth connection and the SIM card are active, which leads to lower energy consumption of the connected mobile phone.

### Connecting a mobile phone as a handsfree device

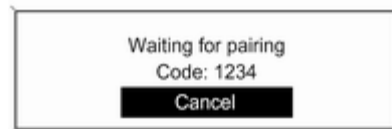

Select **Add device (Handsfree)**. The Bluetooth code to be entered into the mobile phone is displayed.

The Phone portal can now be detected by other Bluetooth devices.

As soon as the mobile phone has detected the Phone portal the Bluetooth code can be entered into the mobile phone.

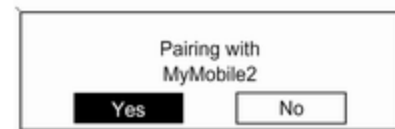

As soon as the Phone portal has detected the mobile phone, the connection set-up can be confirmed.

The mobile phone is adopted in the device list and can be operated via the Phone portal.

### Changing the Bluetooth code

(only relevant for handsfree mode)

The first time a Bluetooth connection to the Phone portal is set up, a default code is displayed. This default code



can be changed at any time. For security reasons a four-digit, randomly selected code must be used for pairing devices.

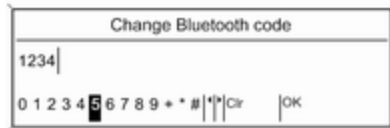

Select **Change Bluetooth code**. On the menu displayed, edit the actual Bluetooth code and accept the modified code using **OK**.

### Connecting a mobile phone via SIM Access Profile (SAP)

Select **Add SIM access device**.

The Phone portal scans for available devices and displays a list of devices found.

### Note

The mobile phone must have Bluetooth activated and be set to visible.

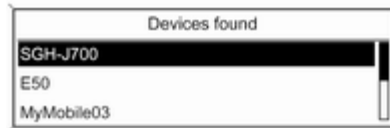

Select the desired mobile phone from the list. The SAP passcode prompt is shown on the Infotainment display containing a 16-digit code.



Enter the displayed SAP passcode in the mobile phone (without spaces). The mobile phone PIN code is shown on the Infotainment display.

If the **PIN request** function is active, the user will have to enter the PIN code of the SIM card in the mobile phone.

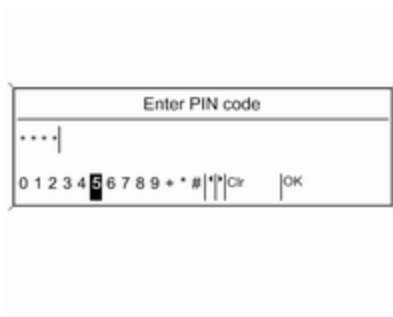

Enter the PIN code of the mobile phone SIM. The mobile phone is paired with the Phone portal. Services of the mobile network provider can be used via the Phone portal.

### Connecting a mobile phone saved in the device list

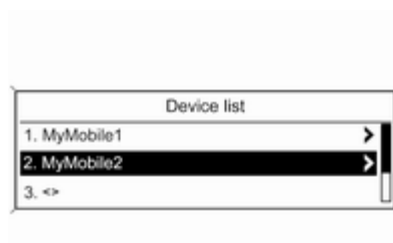

Select the desired mobile phone and then select **Select** in the menu displayed.

As soon as the Phone portal has detected the mobile phone, the connection setup can be confirmed.

The mobile phone can be operated via the Phone portal.

### Removing mobile phone from device list

Select the desired mobile phone from the device list. In the menu displayed select **Delete** and confirm the subsequent message.

### Setting up a connected phone

Various mobile phone settings can be configured in the **Phone settings** menu, if the phone is connected via SAP.

#### Adjusting the ring tone

To change the ring tone characteristic:

Press **CONFIG**.

Select **Phone settings** and then **Ring tone**.

Select the desired option.

To change the ring tone volume:

While the phone rings turn  $\odot$  of the Infotainment system or press **+** or **-** on the steering wheel.

#### Changing security settings

Press **CONFIG**.

Select **Phone settings** and then **Security**.

The security dialogue is displayed.

### Activating/Deactivating PIN request

Select **PIN request On** or **Off**.

Enter the PIN code of the mobile phone SIM card and confirm.

#### Note

This option depends on the individual network provider.

### Changing the PIN code

Select **Change PIN**.

Enter the current PIN code. Enter the new PIN code. Repeat the new PIN code and confirm. The PIN has been changed.

### Configuring network services

Select **Phone settings** and then **Network services**. The Network services dialogue is displayed.

Depending on the network provider and mobile phone there are several options available.

- **Network selection:** choose between automatic or manual network selection.
- **Call waiting:** activate or deactivate call waiting.
- **Call diverting:** select diverting options depending on the situation.
- **Call barring:** configure call barring options depending on the situation.

For details on network services configuration, refer to the mobile phone manual or enquire with the mobile network provider.

### Configuring SMS centre number

The SMS centre number is a phone number that acts as a gateway for transferring SMS messages between mobile phones. This number is usually preset by the network provider.

To configure the SMS centre number select **Phone settings** and then **SMS centre number**. If required, modify the SMS centre number.

### Resetting the mobile phone to factory settings

Select **Phone settings** and then **Restore factory settings**.

## Emergency call

### Warning

Connection setup cannot be guaranteed in all situations. For this reason you should not rely exclusively on a mobile phone when a vitally important communication (e. g. a medical emergency) is concerned.

In some networks it may be necessary for a valid SIM card to be properly inserted in the mobile phone.

### Warning

Bear in mind that you can make and receive calls with the mobile phone, if it is in a service area with

a sufficiently strong signal. Under certain circumstances emergency calls cannot be made on all mobile phone networks; it is possible that they cannot be made when certain network services and/or telephone functions are active. You can enquire about this with the local network operators.

The emergency call number can differ depending on the region and country. Please enquire beforehand about the correct emergency call number for the relevant region.

### **Making an emergency call**

Dial the emergency call number (e.g. 112).

The telephone connection to the emergency call centre is set up.

Answer when the service personnel asks you questions about the emergency.

### **⚠ Warning**

Do not end the call until you are requested to do so by the emergency call centre.

## **Operation**

### **Introduction**

As soon as a connection via Bluetooth has been set up between your mobile phone and the Infotainment system, you can also operate many functions of your mobile phone via the Infotainment system.

Via the Infotainment system, you can, e.g., set up a connection to the telephone numbers stored in your mobile phone or change the telephone numbers.

### **Note**

In the handsfree mode mobile phone operation continues to be possible, e.g. taking a call or adjusting the volume.

After setup of a connection between the mobile phone and the Infotainment system the mobile phone data is transmitted to the Infotainment system. This can take some time depending on the phone model. During this period operation of the mobile phone is possible via the Infotainment system only to a limited extent.

Not every telephone supports all functions of the Phone portal. Therefore deviations from the range of functions described with these specific telephones are possible.

### **Setting the volume for hands-free facility**

Turn  $\odot$  on the Infotainment system or press + or – on the steering wheel.

## Dialling a telephone number



With the telephone main menu active, press the multifunction knob to open the phone operation menu.

Several options for dialling telephone numbers, for using the phone book and call lists, for viewing and editing messages are available.

Using the **Phone off** command the connected phone can be detached from the Phone portal.

## Entering a number manually

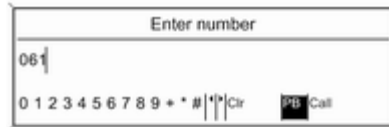

Select **Enter number** and then enter the desired number sequence.

Select **Call** to start the dialling process.

You can switch to the telephone book menu by selecting **PB**.

### Telephone book

After setting up the connection the telephone book is compared with the telephone book in the temporary memory, provided that the same SIM card or same telephone is connected. During this period any newly added entries are not displayed.

If the SIM card or telephone are different, the telephone book is reloaded. This process can take a few minutes depending on the phone model.

### Selecting a telephone number from the telephone book

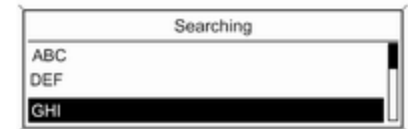

Select **Phone book**. In the displayed menu select the desired first letter range to start a preselection of the telephone book entries that you want to have displayed.

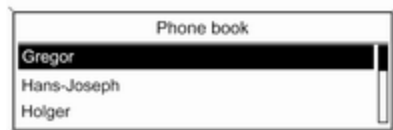

### Note

Telephone book entries are carried over as they are transferred from the mobile phone. The presentation and order of the telephone book entries may be different on the Infotainment system's display and the mobile phone's display.

After having performed the preselection: select the desired entry in the telephone book to display the numbers saved under this entry.

Select the desired number to start the dialling process.

### Call lists

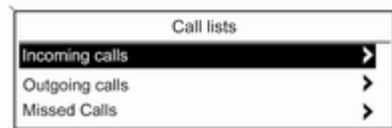

Via the menu **Call lists** the user can view incoming, outgoing and missed calls and dial the relevant numbers. To start a dialling process: select the desired call list, an entry in the call list and finally the desired telephone number.

### Messaging functions



When the mobile phone is paired using the SAP mode, the user can view, compose and send messages via the Phone portal. The messages can also be deleted in this menu.

To view received messages: select **Inbox**.

To view sent messages: select **Outbox**.

To compose a message: select **Write new message**.

### Note

Messages are limited to 70 characters.

## Incoming call

When there is an incoming call a menu is displayed to accept or decline the telephone call.

Select required option.

## Functions during a telephone call

If you currently have a telephone call, press the multifunction knob to open a submenu.

Various options are available depending on the situation and range of functions of the mobile phone:

- **Hang up:** disconnect the telephone connection.
- **Call number:** enter a telephone number to make a second telephone call or perform DTMF (touch-tone dialling), e.g. for voice mail or telephone banking.
- **Detach call:** detach the connection to a conference participant in a telephone conference.
- **Merge calls:** merge two calls when there are several active calls.

- **Switch calls:** switch between calls, if there are several calls.
- **Mute call:** mute a call.

## Mobile phones and CB radio equipment

### Installation instructions and operating guidelines

The vehicle specific installation instructions and the operating guidelines of the mobile phone and handsfree manufacturer must be observed when installing and operating a mobile telephone. Failure to do so could invalidate the vehicle type approval (EU directive 95/54/EC).

Recommendations for fault-free operation:

- The exterior antenna needs to be professionally installed to obtain the maximum range possible.
- Maximum transmission power: 10 watts.
- The mobile phone needs to be installed in a suitable spot. Consider relevant note in the Owner's Manual, chapter **Airbag system**.

Seek advice on predetermined installation points for the external antenna or equipment holder and ways of using devices with a transmission power exceeding 10 watts.

Use of a handsfree attachment without external antenna with mobile telephone standards GSM 900/1800/1900 and UMTS is only permitted if the maximum transmission power of the mobile telephone is 2 watts for GSM 900 or 1 watt for the other types.

For reasons of safety, do not use the phone while driving. Even use of a handsfree set can be a distraction while driving.

**⚠ Warning**

Operation of radio equipment and mobile telephones which fail to meet above mentioned mobile telephone standards is only permitted using an antenna located outside of the vehicle.

**Caution**

Mobile telephones and radio equipment may lead to malfunctions in the vehicle electronics when operated inside the vehicle with no exterior antenna, unless the above mentioned regulations are observed.





# Index

- |                                    |     |                                     |     |
|------------------------------------|-----|-------------------------------------|-----|
| <b>A</b>                           |     | <b>F</b>                            |     |
| Activating CD player.....          | 108 | Favourite lists.....                | 99  |
| Activating speech recognition..... | 114 | <b>G</b>                            |     |
| Activating the radio.....          | 98  | General information.....            |     |
| Autostore lists.....               | 99  | ..... 82, 107, 110, 111, 113, 118   |     |
| <b>B</b>                           |     | <b>H</b>                            |     |
| BACK button.....                   | 91  | Handsfree mode.....                 | 119 |
| Basic operation.....               | 91  | <b>I</b>                            |     |
| Bluetooth.....                     | 118 | Infotainment system                 |     |
| Bluetooth connection.....          | 119 | control elements.....               | 84  |
| <b>C</b>                           |     | instrument panel.....               | 84  |
| CD player                          |     | maximum startup volume.....         | 97  |
| activating.....                    | 108 | Multifunction unit.....             | 84  |
| important information.....         | 107 | speed dependent volume.....         | 97  |
| usage.....                         | 108 | steering wheel audio controls... 84 |     |
| Configuring DAB.....               | 105 | tone settings.....                  | 95  |
| Configuring RDS.....               | 103 | volume of the traffic               |     |
| Control elements overview.....     | 84  | announcements.....                  | 97  |
| <b>D</b>                           |     | volume settings.....                | 97  |
| DAB.....                           | 105 | <b>M</b>                            |     |
| Digital audio broadcasting.....    | 105 | Menu operation.....                 | 91  |
| <b>E</b>                           |     | Mobile phones and CB radio          |     |
| Emergency call.....                | 123 | equipment .....                     | 127 |
| Enhanced Other Networks.....       | 103 | Multifunction knob.....             | 91  |
| EON.....                           | 103 | Mute.....                           | 90  |

<b>O</b>			
Operation.....	124		
<b>P</b>			
Phone			
adjusting ring tones.....	119		
Bluetooth.....	118		
Bluetooth connection.....	119		
call lists.....	124		
control elements.....	118		
dialling a number.....	124		
emergency calls.....	123		
functions during a call.....	124		
handsfree mode.....	119		
important information.....	118		
messaging functions.....	124		
recharging the battery.....	118		
setting the volume.....	124		
SIM Access Profile (SAP).....	119		
telephone book.....	124		
Phone control.....	114		
Playing saved audio files.....	111		
<b>R</b>			
Radio			
Radio data system (RDS).....	103		
activating.....	98		
autostore lists.....	99		
Digital audio broadcasting (DAB).....	105		
favourite lists.....	99		
selecting the waveband.....	98		
station lists.....	100		
station search.....	98		
usage.....	98		
waveband menus.....	100		
Radio data system (RDS) .....	103		
RDS.....	103		
Recharging the phone battery....	118		
Regionalization.....	103		
Retrieving stations.....	99		
<b>S</b>			
SAP mode.....	119		
Selecting the waveband.....	98		
Setting the volume.....	90		
SIM Access Profile (SAP).....	119		
Speech recognition.....	113, 114		
activating.....	114		
phone control.....	114		
usage.....	114		
volume for voice output.....	114		
Speed compensated volume.....	90		
Starting CD playback.....	108		
Station search.....	98		
Storing stations.....	99		
Switching the Infotainment system on or off.....	90		
Switching the radio on.....	98		
<b>T</b>			
Theft-deterrent feature .....	83		
Tone settings.....	95		
Traffic announcements.....	97		
<b>U</b>			
Updating station lists.....	100		
Usage.....	90, 98, 108, 110		
Using the AUX input.....	110		
Using the CD player.....	108		
Using the Infotainment system....	90		
Using the radio.....	98		
Using the USB port.....	111		
<b>V</b>			
Voice recognition.....	113		
Volume for voice output.....	114		
Volume settings.....	97		
<b>W</b>			
Waveband menus.....	100		



---

## CD 400plus (2)

Introduction .....	134
Radio .....	145
CD Player .....	154
AUX input .....	157
USB port .....	158
Bluetooth music .....	161
Phone .....	163
Index .....	172

## Introduction

General information .....	134
Theft-deterrent feature .....	135
Control elements overview .....	136
Usage .....	139
Basic operation .....	140
Tone settings .....	143
Volume settings .....	143

## General information

The Infotainment system provides you with state-of-the-art in-car infotainment.

Using the FM, AM or DAB radio functions, you may register up to 36 stations on six favourites pages.

The integrated audio player will entertain you with audio CDs and MP3/WMA CDs.

You can connect external data storage devices, e.g. iPod, MP3 player, USB stick, or a portable CD player to the Infotainment system as further audio sources; either via cable or via Bluetooth.

In addition, the Infotainment system is equipped with a Phone portal that allows for comfortable and safe use of your mobile phone in the vehicle.

Optionally, the Infotainment system can be operated using controls on the steering wheel.

The well-thought-out design of the control elements and the clear displays enable you to control the system easily and intuitively.

## Note

This manual describes all options and features available for the various Infotainment systems. Certain descriptions, including those for display and menu functions, may not apply to your vehicle due to model variant, country specifications, special equipment or accessories.

## Display

The CD 400plus is available in two variants; noticeable difference is the display. The second variant has the following display.

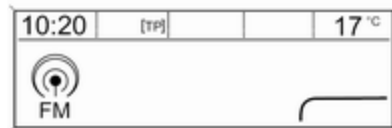

## Important information on operation and traffic safety

### Warning

The Infotainment system must be used so that the vehicle can be driven safely at all times. If in doubt, stop the vehicle and operate the Infotainment system while the vehicle is stationary.

### Radio reception

Radio reception may be disrupted by static, noise, distortion or loss of reception due to:

- changes in distance from the transmitter
- multipath reception due to reflection
- shadowing

### Theft-deterrent feature

The Infotainment system is equipped with an electronic security system for the purpose of theft deterrence.



The Infotainment system therefore functions only in your vehicle and is worthless to a thief.

## Control elements overview

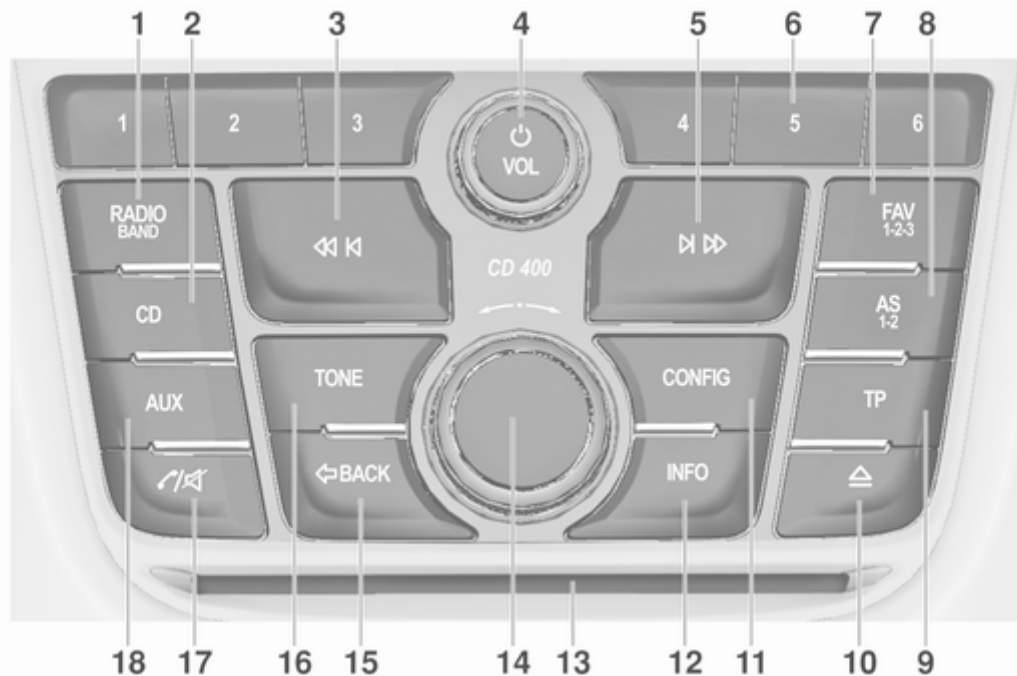
## CD 400plus





- |   |  |  |
|---|--|--|
| <p><b>1 RADIO</b> ..... 145</p> <p>    Activate radio or change waveband ..... 145</p> <p><b>2 CD</b> ..... 154</p> <p>    Start CD/MP3/WMA playback ..... 155</p> <p><b>3 Search backward</b> ..... 145</p> <p>    Radio: search backward ..... 145</p> <p>    CD/MP3/WMA: skip track backward ..... 155</p> <p><b>4</b>  ..... 139</p> <p>    Press: switch on/off ..... 139</p> <p>    Infotainment system ..... 139</p> <p>    Turn: adjust volume ..... 139</p> <p><b>5 Search forward</b> ..... 145</p> <p>    Radio: search forward ..... 145</p> <p>    CD/MP3/WMA: skip track forward ..... 155</p> <p><b>6 Radio station buttons 1...6</b> .. 146</p> <p>    Long press: save station ..... 146</p> <p>    Short press: select station . . 146</p> | <p><b>7 FAV 1/2/3</b> ..... 146</p> <p>    Lists of favourites (preset radio stations) ..... 146</p> <p><b>8 AS 1/2</b> ..... 146</p> <p>    Automatic memory levels (preset radio stations) ..... 146</p> <p>    Short press: select autostore list ..... 146</p> <p>    Long press: save stations automatically ..... 146</p> <p><b>9 TP</b> ..... 150</p> <p>    Activate or deactivate radio traffic service ..... 150</p> <p>    If Infotainment system is switched off: display time and date ..... 150</p> <p><b>10 CD ejection</b> ..... 155</p> <p><b>11 CONFIG</b> ..... 143</p> <p>    Open settings menu ..... 143</p> | <p><b>12 INFO</b> ..... 136</p> <p>    Radio: information on the currently played station ..... 145</p> <p>    CD/MP3/WMA: information on the currently inserted CD ..... 155</p> <p><b>13 CD slot</b> ..... 155</p> <p><b>14 Multifunction knob</b> ..... 140</p> <p>    Turn: mark menu options or set numeric values ..... 140</p> <p>    Press: select/activate the marked option; confirm set value; switch function on/off 140</p> <p><b>15 BACK</b> ..... 140</p> <p>    Menu: one level back ..... 140</p> <p>    Input: delete last character or entire entry ..... 140</p> <p><b>16 TONE</b> ..... 143</p> <p>    Tone settings ..... 143</p> <p><b>17</b>  /  ..... 163</p> <p>    Open telephone main menu 166</p> <p>    Activate/deactivate mute ..... 139</p> |
|---|--|--|

18 AUX ..... 157  
 Change to external audio source ..... 157

### Steering wheel audio controls

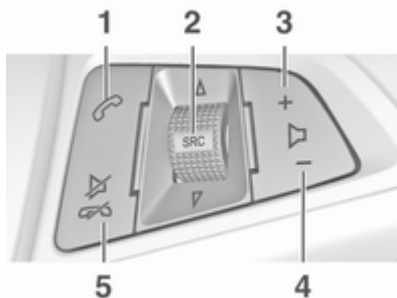

- 1
  - Short press: take phone call 163
  - or dial number in call list ..... 166
  - Long press: show call list .... 166
- 2 **SRC** (Source) ..... 139
  - Press: select audio source .. 139
  - With radio active: turn upwards/downwards to select next/previous preset radio station ..... 145

With CD player active: turn upwards/downwards to select next/previous CD/MP3/WMA track ..... 155

With Phone portal active: turn upwards/downwards to select next/previous entry in call list ..... 166

With Phone portal active and calls waiting: turn upwards/downwards to switch between calls ..... 166

- 3 +
  - Increase volume ..... 139
- 4 -
  - Reduce volume ..... 139
- 5
  - Short press: end/decline call ..... 166
  - or close call list ..... 166
  - or activate/deactivate mute . 139

## Usage

### Control elements

The Infotainment system is operated via function buttons, a multifunction knob and menus that are shown on the display.

Inputs are made optionally via:

- the control panel on the Infotainment system ↗ 136
- audio controls on the steering wheel ↗ 136

### Switching the Infotainment system on or off

Press  $\odot$  briefly. After switching on, the last selected Infotainment source becomes active.

Press  $\odot$  again to turn the system off.

### Automatic switch-off

If the Infotainment system is switched on pressing  $\odot$  while the ignition is turned off, it will switch off again automatically 10 minutes after the last user input.

### Setting the volume

Turn  $\odot$ . The current setting is shown on the display.

When the Infotainment system is switched on, the last selected volume is set, provided this setting is lower than the maximum start-up volume (see below).

The following inputs can be made separately:

- the maximum start-up volume ↗ 143
- the volume of traffic announcements ↗ 143

### Speed compensated volume

When speed compensated volume is activated ↗ 143, the volume is adapted automatically to make up for the road and wind noises as you drive.

### Mute function

Press  $\text{M}$  /  $\text{M}$  or  $\text{M}$  (if Phone portal available: press for a few seconds) to mute the audio sources.

To cancel the mute function: turn  $\odot$  or press  $\text{M}$  /  $\text{M}$  (if Phone portal available: press for a few seconds) or press  $\text{M}$  again.

### Volume limitation at high temperatures

At very high temperatures inside the vehicle the Infotainment system limits the maximum adjustable volume. If necessary, the volume is decreased automatically.

## Modes of operation

### Radio

Press **RADIO** to open the radio main menu or to change between the different wavebands.

Press the multifunction knob to open the waveband menus with options for the station selection.

For a detailed description of the radio functions ↗ 145.

### Audio players

Press **CD** or **AUX** once or several times to open the USB, iPod or AUX main menu (if available) or to switch between these menus.

Press the multifunction knob to open the relevant menus with options for the track selection.

For a detailed description of CD player functions ⇨ 154, AUX functions ⇨ 157, USB port functions ⇨ 158 and Bluetooth music functions ⇨ 161.

### Phone

Press **☎** / **☎** briefly to open the telephone menu.

Press the multifunction knob to open the phone menu with options for the input and selection of numbers.

For a detailed description of the Phone portal ⇨ 163.

### System settings

#### Adjusting the language

The menu texts on the Infotainment system's display can be displayed in various languages.

Press **CONFIG** to open the **Settings** menu.

Select the **Languages** menu item in the **Settings** menu to display the respective menu.

Choose the desired language for the menu texts.

#### Note

For a detailed description of menu operation ⇨ 140.

#### Time and date settings

For a detailed description, refer to your Owner's Manual.

### Basic operation

#### Multifunction knob

The multifunction knob is the central control element for the menus.

Turn the multifunction knob:

- to mark a menu option
- to set a numeric value

Press the multifunction knob:

- to select or activate the marked option
- to confirm a set value
- to switch a system function on/off

#### BACK button

Press **BACK** briefly:

- to exit a menu
- to return from a submenu to the next higher menu level
- to delete the last character in a character sequence

Press and hold **BACK** for a few seconds to delete the entire entry.

## Examples of menu operation

### Selecting an option

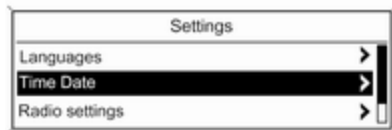

Turn the multifunction knob to move the cursor (= coloured background) to the desired option.

Press the multifunction knob to select the marked option.

### Submenus

An arrow on the right-hand edge of the menu indicates that after selection of the option a submenu with further options will be opened.

### Activating a setting

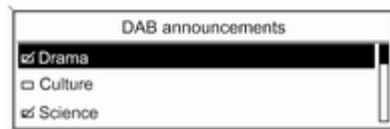

Turn the multifunction knob to mark the desired setting.

Press the multifunction knob to activate the setting.

### Setting a value



Turn the multifunction knob to change the current value of the setting.

Press the multifunction knob to confirm the set value.

The cursor then switches to the next value. If all values are set, you are automatically returned to the next higher menu level.

## Adjusting a setting

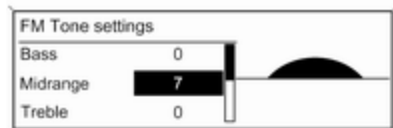

Turn the multifunction knob to adjust the setting.

Press the multifunction knob to confirm the setting.

## Switching a function on or off

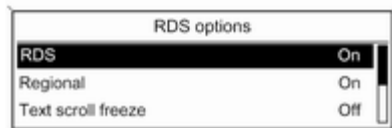

Turn the multifunction knob to mark the function to be switched on or off.

Press the multifunction knob to switch between the settings **On** and **Off**.

## Entering a character sequence



To enter character sequences, e.g. PIN codes or telephone numbers:

Turn the multifunction knob to mark the desired character.

Press the multifunction knob to confirm the marked character.

The last character in the character sequence can be deleted by selecting **☒** on the display or pressing **BACK** on the instrument panel. Pressing and holding **BACK** deletes the entire entry.

To change the position of the cursor in the character sequence already entered, select ◀ or ▶ on the display.

## Tone settings

In the tone settings menu the tone characteristics can be set differently for each radio waveband and each audio player source.

Press **TONE** to open the tone settings menu.

### Setting bass, midrange, and treble

Scroll through the list and select **Bass**, **Midrange** or **Treble**.

Set the desired value for the selected option.

### Setting the volume distribution between front and rear

Scroll through the list and select **Fader**.

Set the desired value.

### Setting the volume distribution between right and left

Scroll through the list and select **Balance**.

Set the desired value.

### Selecting a tone style

Scroll through the list and select **EQ** (Equaliser). The **EQ presets** menu is displayed.



The displayed options offer optimised bass, middle, and treble presettings for the relevant style of music.

Select the desired option.

### Setting an individual setting to "0"

Select the desired option and press the multifunction knob for a few seconds.

The value is reset to "0".

### Setting all settings to "0" or "OFF"

Press **TONE** for a few seconds.

All values are reset to "0", the EQ preset is set to "OFF".

## Volume settings

### Adjusting the speed compensated volume

Press **CONFIG** to open the **Settings** menu.

Select **Radio settings** and then **Auto volume control**.

The **Auto volume control** function can be deactivated or the degree of the volume adaptation can be selected in the menu displayed.

Select the desired option.

### **Adjusting the maximum startup volume**

Press **CONFIG** to open the **Settings** menu.

Select **Radio settings** and then **Maximum startup volume**.

Set the desired value.

### **Adjusting the volume of traffic announcements**

The volume of traffic announcements can be preset to increase or decrease in proportion to the normal audio volume.

Press **CONFIG** to open the **Settings** menu.

Select **Radio settings**, **RDS options** and then **TA volume**.

Set the desired value.

### **Adjusting the volume of the ring tone**

Press **CONFIG** to open the **Settings** menu.

Select **Phone settings**, **Sound & Signals** and then **Ring Volume**.

Set the desired value.



## Radio

Usage .....	145
Station search .....	145
Autostore lists .....	146
Favourite lists .....	146
Waveband menus .....	147
Radio data system (RDS) .....	150
Digital audio broadcasting .....	151

## Usage

### Activating the radio

Press **RADIO** to open the radio main menu.



The station last played will be received.

### Selecting the waveband

Press **RADIO** once or several times to select the desired waveband.

The station last played in that waveband will be received.

## Station search

### Automatic station search

Briefly press **◀◀** or **▶▶** to play the previous or next station in the station memory.

### Manual station search

Press and hold **◀◀** or **▶▶**. Release the respective button when the required frequency has almost been reached on the frequency display.

A search is made for the next station that can be received and it is played automatically.

#### Note

Manual station search: If the radio does not find a station, it switches automatically to a more sensitive search level. If it still does not find a station, the frequency that was last active is set again.

#### Note

FM waveband: when the RDS function is activated, only RDS stations  $\hookrightarrow$  150 are searched for, and

when the radio traffic service (TP) is activated, only traffic service stations ↷ 150 are searched for.

### Manual station tuning

In the radio main menu, press the multifunction knob to open the respective waveband menu and select manual tuning, e.g. **FM manual tuning**.

On the pop-up frequency display, turn the multifunction knob and set the optimal reception frequency.

### Autostore lists

The stations received best in a waveband can be searched for and stored automatically via the autostore function.

Each waveband has 2 autostore lists (**AS-Stations 1**, **AS-Stations 2**), in each of which 6 stations can be stored.

AS-Stations		FM AS1	
1	FM 89.0	2	FM 92.1
3	FM 93.8	4	FM 95.6
5	FM 95.9	6	FM 97.2

#### Note

The currently received station is marked by 📻.

### Automatic station storing

Keep **AS 1-2** pressed until an autostore message is displayed. The 12 strongest stations in the current waveband will be stored in the 2 autostore lists.

To cancel the autostore procedure, press the multifunction knob.

### Storing stations manually

Stations can also be stored manually in the autostore lists.

Set the station to be stored.

Briefly press **AS 1-2** once or several times to switch to the desired list.

To store the station in a list position: press the corresponding station button **1...6** until a confirmation message is displayed.

#### Note

Manually stored stations are overwritten in an automatic station storing process.

### Retrieving a station

Briefly press **AS 1-2** once or several times to switch to the desired list.

Briefly press one of the station buttons **1...6** to open the station at the corresponding list position.

### Favourite lists

Stations of all wavebands can be stored manually in the favourite lists.

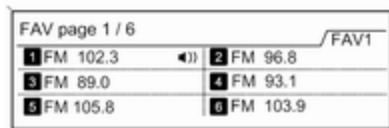

6 stations can be stored in each favourite list. The number of available favourite lists can be set (see below).

#### Note

The currently received station is marked by .

### Storing a station

Set the station to be stored.

Briefly press **FAV 1-2-3** once or several times to switch to the desired list.

To store the station in a list position: press the corresponding station button **1...6** until a confirmation message is displayed.

### Retrieving a station

Briefly press **FAV 1-2-3** once or several times to switch to the desired list.

Briefly press one of the station buttons **1...6** to open the station at the corresponding list position.

### Defining the number of available favourite lists

Press **CONFIG** to open the **Settings** menu.

Select **Radio settings** and then **Radio favourites** to open the menu **Max. number of favourites pages**.

Select the desired number of available favourite lists.

### Waveband menus

Alternative facilities for station selection are available via waveband specific menus.



#### Note

The following displays are shown as examples.

### Stations lists

When in a radio main menu, turn the multifunction knob to open the stations list of the respective waveband.

All receivable FM, AM or DAB stations in the current reception area are displayed.

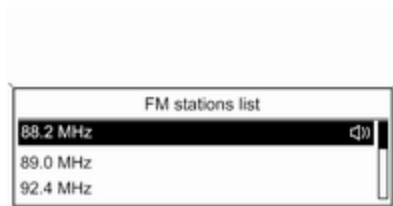
**Note**

If no station list has been created beforehand, the Infotainment system performs an automatic station search.

Select the desired station.

**Note**

The currently received station is marked by .

**Updating the stations lists**

When in a radio main menu, press the multifunction knob to open the relevant waveband menu.

If the stations stored in the waveband-specific station list can no longer be received:

Select the menu item update stations list in the respective waveband menu, e.g. **Update FM stations list**.

A station search is started. Once the search is completed, the station last received will be played.

To cancel the station search: press the multifunction knob.

**Note**

If the Infotainment system features a dual tuner, the stations lists are continuously updated in the background. No manual update is required.

**Note**

If a waveband-specific station list is updated, the corresponding category list is also updated.

**Favourites list**

Being in a radio main menu, press the multifunction knob to open the relevant waveband menu.

Select **Favourites list**. All stations saved in the favourite lists are displayed.





Select the desired station.

**Note**

The currently received station is marked by .

**Category lists**

Numerous RDS  150 and DAB  151 stations broadcast a PTY code, which specifies the type of programme transmitted (e.g. news). Some stations also change the PTY code depending on the content currently being transmitted.

The Infotainment system stores these stations, sorted by programme type, in the corresponding category list.

To search for a programme type determined by station: select the waveband specific category list option.

A list of programme types currently available is displayed.

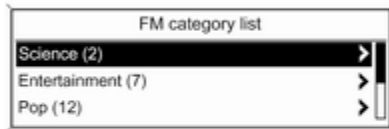

Select the desired programme type.

A list of stations is displayed that transmit a programme of the selected type.

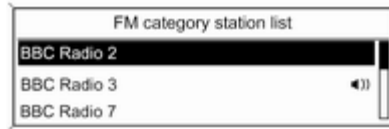

Select the desired station.

The category list is updated, too, when the corresponding waveband specific station list is updated.

#### Note

The currently received station is marked by .

### DAB announcements

Besides their music programmes, numerous DAB stations  151 broadcast various announcement categories.

The currently received DAB service (programme) is interrupted when any announcement of previously activated categories is pending.

### Activating announcement categories

Being in the **DAB menu**, select **DAB announcements** to display the respective menu.

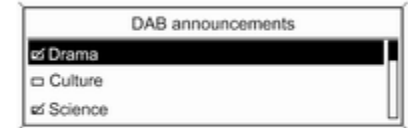

Activate the desired announcement categories.

Several announcement categories can be selected at the same time.

**Note**

The following options are only available, if **RDS** is set to **On**.

**Radio data system (RDS)**

RDS is a service of FM stations that considerably facilitates the finding of the desired station and its fault-free reception.

**Advantages of RDS**

- On the display, the programme name of the set station appears instead of its frequency.
- During a station search, the Infotainment system tunes in to RDS stations only.
- The Infotainment system always tunes into the best receivable broadcasting frequency of the set station by means of AF (Alternative Frequency).
- Depending on the station that is received, the Infotainment system displays radio text that can contain, e.g. information about the current programme.

**Configuring RDS**

Press **CONFIG** to open the **Settings** menu.

Select **Radio settings** and then **RDS options**.

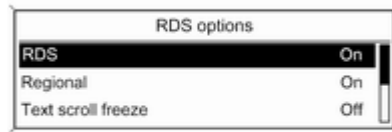

Set **RDS** to **On** or **Off**.

**Note**

If RDS is switched off, it will be automatically switched on again when a radio station is changed (by search function or preset button).

**Note**

The following options are only available, if **RDS** is set to **On**.

**RDS options****Switching regionalisation on and off**

At certain times some RDS stations broadcast regionally different programmes on different frequencies.

Set **Regional** to **On** or **Off**.

If regionalisation is switched on, only alternative frequencies (AF) with the same regional programmes are selected.

If regionalisation is switched off, alternative frequencies of the stations are selected without regard to regional programmes.

**RDS scrolling text**

Some RDS stations hide the programme name in the display line in order to display additional information.

To prevent additional information being displayed:

Set **Text scroll freeze** to **On**.

**Radio text**

If the RDS function is activated and a RDS station is currently received, information about the current programme and the music track currently playing are displayed below the programme name.

To show or hide the information, set **Radio text** to **On** or **Off**.

**TA volume**

The volume of traffic announcements (TA) can be preset. For a detailed description ↪ 143.

**Radio traffic service**

(TP = Traffic Programme)

Radio traffic service stations are RDS stations that broadcast traffic news.

**Switching the radio traffic service on and off**

To switch the traffic announcement standby facility of the Infotainment system on and off:

Press **TP**.

- If the radio traffic service is switched on, [ ] is displayed in the radio main menu.
- Only radio traffic service stations are received.
- If the current station is not a radio traffic service station, a search is started automatically for the next radio traffic service station.
- If a radio traffic service station has been found, [TP] is displayed in the radio main menu.
- Traffic announcements are played at the preset TA volume ↪ 143.
- If the radio traffic service is switched on, CD/MP3 playback is interrupted for the duration of the traffic announcement.

**Listening to traffic announcements only**

Switch on the radio traffic service and completely turn down the volume of the Infotainment system.

**Blocking out traffic announcements**

To block out a traffic announcement, e.g. during CD/MP3 playback:

Press **TP** or the multifunction knob to confirm the cancelling message on the display.

The traffic announcement is cancelled, but the radio traffic service remains switched on.

**Digital audio broadcasting**

Digital audio broadcasting (DAB) is an innovative and universal broadcast system.

DAB stations are indicated by the programme name instead of the broadcasting frequency.



## General information

- With DAB, several radio programmes (services) can be broadcasted on a single frequency (ensemble).
- Besides high-quality digital audio services, DAB is also able to transmit programme-associated data and a multitude of other data services including travel and traffic information.
- As long as a given DAB receiver can pick up the signal sent out by a broadcasting station (even if the signal is very weak), sound reproduction is ensured.
- There is no fading (weakening of the sound that is typical of AM or FM reception). The DAB signal is reproduced at a constant volume.
- If the DAB signal is too weak to be picked up by the receiver, reception is interrupted completely. This incident can be avoided by activating **Auto ensemble linking** and/or **Auto linking DAB-FM** in the DAB settings menu.

- Interference caused by stations that are on nearby frequencies (a phenomenon that is typical of AM and FM reception) does not occur with DAB.
- If the DAB signal is reflected by natural obstacles or buildings, the reception quality of DAB is improved, whereas AM or FM reception is considerably impaired in such cases.
- When DAB reception is enabled, the FM tuner of the Infotainment system remains active in the background and continually searches for the best receivable FM stations. If TP ⇨ 150 is activated, traffic announcements of the FM station which is currently best receivable are issued. Deactivate TP, if DAB reception should not be interrupted by FM traffic announcements.

## Configuring DAB

Press **CONFIG**.

Select **Radio settings** and then **DAB settings**.

The following options are available in the configuration menu:

### Auto ensemble linking

With this function activated, the device switches over to the same service (programme) on another DAB ensemble (frequency) when the DAB signal is too weak to be picked up by the receiver.

Set the function to **On** or **Off**.

### Auto linking DAB-FM

With this function activated, the device switches over to a corresponding FM station of the active DAB service when the DAB signal is too weak to be picked up by the receiver.

Set the function to **On** or **Off**.

### Dynamic audio adaption

With this function activated, the dynamic range of the DAB signal is reduced. That means the level of the loud sounds is reduced and the level of the quiet sounds is increased. Therefore, the volume of the Infotainment system can be raised to



a point where the quiet sounds are audible, without the loud sounds being too loud.

Set the function to **On** or **Off**.

### **Band selection**

Select the menu item **Band selection** to display the respective menu.

To define which DAB wavebands are to be received by the Infotainment system, activate one of the options:

**L-Band:** 1452 - 1492 MHz, earth and satellite radio

**Band III:** 174 - 240 MHz, earth radio

**Both**

## CD Player

General information .....	154
Usage .....	155

### General information

The Infotainment system's CD player can play audio CDs and MP3/WMA CDs.

### Important information

#### Caution

Under no circumstances place single-CDs with a diameter of 8 cm or shaped CDs in the audio player.

You must not put any stickers on CDs. These discs can get jammed in the CD drive and ruin the player. Replacement of the device will then be necessary.

- The following CD formats can be used:  
CD-ROM Mode 1 and Mode 2  
CD-ROM XA Mode 2, Form 1 and Form 2
- The following file formats can be used:  
ISO 9660 Level 1, Level 2 (Romeo, Joliet)

MP3 and WMA files written in any format other than listed above may not play correctly and their file names and folder names may not be displayed correctly.

- Audio CDs with copy protection, which are not in compliance with the audio CD standard, may not play correctly or not at all.
- Self-recorded CD-Rs and CD-RWs are more vulnerable to mishandling than prerecorded CDs. Correct handling, especially in the case of self-recorded CD-Rs and CD-RWs, must be ensured (see below).
- Self-recorded CD-Rs and CD-RWs may not play correctly or not at all. In such cases it is not the equipment that is at fault.
- On mixed mode CDs (audio tracks and compressed files, e.g. MP3, are stored), the audio tracks part and the compressed files part can be played separately.
- Avoid leaving fingerprints when you change CDs.

- Put CDs back in their sleeves immediately after removing them from the CD player in order to protect them from damage and dirt.
- Dirt and liquids on CDs can smear the lens of the CD player inside the device and cause faults.
- Protect CDs from heat and direct sunlight.
- The following restrictions apply to MP3/WMA CDs:  
Bit rate: 8 kbit/s - 320 kbit/s  
Sampling frequency: 48 kHz, 44.1 kHz, 32 kHz (for MPEG-1) and 24 kHz, 22.05 kHz, 16kHz (for MPEG-2)
- The following restrictions apply to the data stored on an MP3/WMA CD:  
Number of tracks: max. 999  
Number of tracks per folder level: max. 512  
Folder structure depth: max. 10 levels

### Note

This chapter deals only with playing MP3 files since the operation for MP3 and WMA files is identical. When a CD with WMA files is loaded MP3 related menus are displayed.

## Usage

### Starting CD playback

Press **CD** once or several times to open the CD or MP3 main menu.



If there is a CD in the CD player, CD playback is started.

Depending on the data stored on the audio CD or MP3 CD, differing information about the CD and the current music track will be shown on the display.

### Inserting a CD

Insert a CD with the printed side facing up into the CD slot until it is drawn in.

#### Note

If a CD is inserted, ● is shown on the display.

### Skipping to the next or previous track

Briefly press ◀◀ K or K ▶▶.

### Fast forward or rewind

Press and hold ◀◀ K or K ▶▶ to fast forward or fast rewind the current track.

### Selecting tracks using the audio CD menu

Press the multifunction knob to open the **CD menu**.

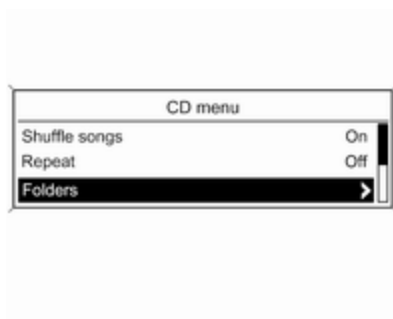

### Shuffle songs

To play all tracks in a random order: set this function to **On**.

#### Note

If this function is activated,  is shown in the respective main menu.

### Repeat

To repeatedly listen to a track: set this function to **On**.

#### Note

If this function is activated,  is shown in the respective main menu.

### Track list

To select a track on the CD: select **Track list** and then select the desired track.

### Folders

To select a track from a folder: select **Folders**. A list of the folders stored on the CD is displayed.

Select one of the folders and then select the desired track.

#### Note

This menu item is only available, if an MP3 CD is inserted.

### Search...

To open a menu for track search and selection: select **Search...**

Select one of the categories and then select the desired track.

#### Note

This menu item is only available, if an MP3 CD is inserted.

### Removing a CD

Press .

The CD is pushed out of the CD slot.

If the CD is not removed after ejection, it will be drawn back in again automatically after a few seconds.

## AUX input

General information .....	157
Usage .....	157

### General information

On the control panel of the Infotainment system ⇨ 136, there is an AUX input for the connection of external audio sources.

It is possible, for example, to connect a portable CD player with a 3.5 mm jack plug to the AUX input.

#### Note

The socket must always be kept clean and dry.

### Usage

Press **AUX** once or several times to activate the AUX mode.

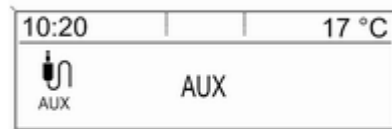

Turn  $\odot$  of the Infotainment system to adjust the volume.

All other functions can be operated only via the control elements of the audio source.

## USB port

General information .....	158
Playing saved audio files .....	159

### General information

In the centre console below the climate controls there is a USB socket for the connection of external audio data sources.

#### Note

The socket must always be kept clean and dry.

An MP3 player, USB drive, SD card (via USB connector/adaptor), or iPod can be connected to the USB port.

When connected to the USB port, various functions of the above devices can be operated via the controls and menus of the Infotainment system.

#### Note

Not all MP3 player, USB drive, SD card or iPod models are supported by the Infotainment system.

### Important information

- The external devices connected to the USB port must comply with the USB Mass Storage Class specification (USB MSC).

- Devices connected via USB are supported according to USB Specification V 2.0. Maximum supported speed: 12 Mbit/s.
- Only devices with a FAT16/FAT32 file system are supported.
- Hard disk drives (HDD) are not supported.
- USB hubs are not supported.
- The following file formats can be used:
  - ISO9660 Level 1, Level 2 (Romeo, Joliet).
  - MP3 and WMA files written in another format than listed above may not play correctly, and their file names and folder names may not be displayed correctly.
- The following restrictions apply to the files stored on the external device:
  - Bit rate: 8 kbit/s - 320 kbit/s
  - Sampling frequency: 48 kHz, 44.1 kHz, 32 kHz (for MPEG-1) and

24 kHz, 22.05 kHz, 16kHz (for MPEG-2).

- The following restrictions apply to the data stored on external devices connected to the USB port:

Number of tracks: max. 999

Number of tracks per folder level: max. 512

Folder structure depth: max. 10 levels

WMA files with Digital Rights Management (DRM) from online music shops cannot be played.

WMA files can only be played safely, if they were created with Windows Media Player version 9 or later.

Applicable playlist extensions: .m3u, .pls, .wpl

Playlist entries must be in the form of relative paths.

The system attribute for folders/ files that contain audio data must not be set.

## Playing saved audio files

Press **AUX** once or several times to activate the MP3 or iPod mode.

Playback of the audio data stored on the device is started automatically.



## Using the device-specific menu

Press the multifunction knob to open the menu of the device currently connected.

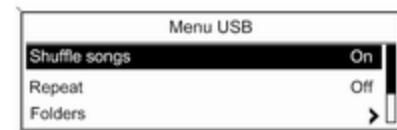

### Shuffle songs

To play all tracks in a random order: set this function to **On**.

#### Note

If this function is activated,  is shown in the respective main menu.

### Repeat

To repeatedly listen to a track: set this function to **On**.

#### Note

If this function is activated,  is shown in the respective main menu.

### **Folders**

To select a track from a folder: select **Folders**. A list of the folders stored on the device is displayed.

Select one of the folders and then select the desired track.

### **Note**

This menu item is not available, if an iPod is connected.

### **Search...**

To open a menu for track search and selection: select **Search...**

Select one of the categories and then select the desired track.

### **Removing the device**

To safely remove the device, select **Remove USB** or **Eject iPod** and then disconnect the device.



## Bluetooth music

General information .....	161
Operation .....	161

### General information

Bluetooth enabled audio sources (e.g. music mobile phones, MP3 players featuring Bluetooth, etc.) which support the Bluetooth music protocol A2DP can be connected wirelessly to the Infotainment system.

### Important information

- The Infotainment system only connects to Bluetooth devices that support A2DP (Advanced Audio Distribution Profile) version 1.2 or higher.
- The Bluetooth device must support AVRCP (Audio Video Remote Control Profile) version 1.0 or higher. If the device does not support AVRCP, only the volume can be controlled via the Infotainment system.
- Before connecting the Bluetooth device to the Infotainment system, become acquainted with its user guide for Bluetooth functions.

### Operation

#### Prerequisites

The following prerequisites must be met in order to use the Bluetooth music mode of the Infotainment system:

- The Bluetooth function of the Infotainment system must be activated ⇨ 164.
- The Bluetooth function of the external Bluetooth audio source must be activated (see user guide of the device).
- Depending on the external Bluetooth audio source, it may be required to set the device to "visible" (see user guide of the device).
- The external Bluetooth audio source must be paired and connected to the Infotainment system ⇨ 164.

#### Activating the Bluetooth music mode

Press **AUX** once or several times to activate the Bluetooth music mode.

Bluetooth music playback has to be started and paused/stopped via the Bluetooth device.

### **Operation via Infotainment system**

#### **Adjusting the volume**

The volume can be adjusted via the Infotainment system ↗ 139.

#### **Skipping to previous or next track**

Briefly press ◀ ⏮ or ⏭ ▶ on the control panel of the Infotainment system.

## Phone

General information .....	163
Bluetooth connection .....	164
Emergency call .....	166
Operation .....	166
Mobile phones and CB radio equipment .....	170

### General information

The Phone portal provides you with the possibility of having mobile phone conversations via a vehicle microphone and the vehicle loudspeakers as well as operating the most important mobile phone functions via the Infotainment system in the vehicle. To be able to use the Phone portal, the mobile phone must be connected to the Infotainment system via Bluetooth.

Not all Phone portal functions are supported by every mobile phone. The possible phone functions depend on the relevant mobile phone and network provider. You will find further information on this in the operating instructions for your mobile phone or you can enquire about them with your network provider.

### Important information for operation and traffic safety

#### Warning

Mobile phones have effects on your environment. For this reason, safety regulations and directions have been prepared. You should be familiar with the related directions before you use the telephone function.

#### Warning

Use of the hands-free facility while driving can be dangerous because your concentration is reduced when telephoning. Park your vehicle before you use the hands-free facility. Follow the stipulations of the country in which you find yourself at present.

Do not forget to follow the special regulations that apply in specific areas and always switch off the mobile phone if the use of mobile

phones is prohibited, if interference is caused by the mobile phone or if dangerous situations can occur.

## Bluetooth

The Phone portal is certified by the Bluetooth Special Interest Group (SIG).

You will find further information about the specification on the Internet at <http://www.bluetooth.com>

## Bluetooth connection

Bluetooth is a radio standard for the wireless connection of e.g. a telephone with other devices. Data such as a telephone book, call lists, the network operator's name, and field strength can be transferred. The functionality can be restricted depending on the telephone type.

To be able to set up a Bluetooth connection with the Phone portal, the Bluetooth function of the mobile phone must be activated and the mobile phone must be set to "visible".

Find a detailed description in the operating instructions for the mobile phone.

### Activating Bluetooth

Press **CONFIG** to open the **Settings** menu.

Select **Phone settings**.

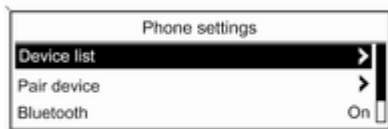

Set **Bluetooth** to **On**.

### Pairing a Bluetooth device

Press **CONFIG** to open the **Settings** menu. Select **Phone settings** and then **Pair device**.

The following display is shown.

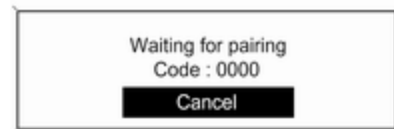

As soon as the Phone portal of the Infotainment system is detected, it appears in the device list of your Bluetooth device. Select the Phone portal.

Upon request, enter the PIN code on your Bluetooth device. The devices are paired and connected.

### Note

Your mobile phone book will be downloaded automatically. The presentation and order of the telephone book entries may be different on the Infotainment system's display and the mobile phone's display.

If the Bluetooth connection has been successfully performed: in case another Bluetooth device had been connected to the Infotainment system, this device is now disconnected from the system.

If the Bluetooth connection failed: start the procedure described above again or consult the user guide of the Bluetooth device.

#### Note

A maximum of 5 devices can be paired with the Infotainment system.

### Changing the Bluetooth code

Press **CONFIG** to open the **Settings** menu.

Select **Phone settings** and then **Change Bluetooth code**.

Enter the desired four-digit PIN code and confirm your input with **OK**.

### Connecting another paired device

Press **CONFIG** to open the **Settings** menu.

Select **Phone settings** and then **Device list**. A list of all Bluetooth devices currently paired to the Infotainment system is displayed.

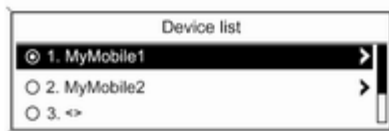

Select the desired device. A submenu is displayed.

Select **Select** to establish the connection.

### Disconnecting a device

Press **CONFIG** to open the **Settings** menu.

Select **Phone settings** and then **Device list**. A list of all Bluetooth devices currently paired to the Infotainment system is displayed.

Select the paired device. A submenu is displayed.

Select **Disconnect** to disconnect the device.

### Removing a paired device

Press **CONFIG** to open the **Settings** menu.

Select **Phone settings** and then **Device list**. A list of all Bluetooth devices currently paired to the Infotainment system is displayed.

Select the desired device. A submenu is displayed.

If the device is connected, it has to be disconnected first (see above).

Select the submenu item **Delete** to remove the device.

### Restoring the factory defaults

The phone settings, e.g. the device list, the Bluetooth code, and the ring tone, can be reset to the factory defaults.

Press **CONFIG** to open the **Settings** menu. Select **Phone settings** and then **Restore factory settings**.

The submenu prompts you with a question. To reset all values to the factory defaults, select **Yes**.

## Emergency call

### ⚠ Warning

Connection setup cannot be guaranteed in all situations. For this reason you should not rely exclusively on a mobile phone when a vitally important communication (e.g. a medical emergency) is concerned.

In some networks it may be necessary for a valid SIM card to be properly inserted in the mobile phone.

### ⚠ Warning

Bear in mind that you can make and receive calls with the mobile phone, if it is in a service area with a sufficiently strong signal. Under certain circumstances emergency calls cannot be made on all mobile phone networks; it is possible that they cannot be made when certain network services and/or telephone functions are active. You can enquire about this with the local network operators.

The emergency call number can differ depending on the region and country. Please enquire beforehand about the correct emergency call number for the relevant region.

### Making an emergency call

Dial the emergency call number (e.g. **112**).

The telephone connection to the emergency call centre is set up.

Answer when the service personnel questions you about the emergency.

### ⚠ Warning

Do not end the call until you are requested to do so by the emergency call centre.

## Operation

As soon as a Bluetooth connection has been set up between your mobile phone and the Infotainment system, you can also operate many functions of your mobile phone via the Infotainment system.

Via the Infotainment system, you can, e.g., set up a connection to the telephone numbers stored in your mobile phone or change the telephone numbers.

### Note

In the handsfree mode, mobile phone operation is still possible, e.g. taking a call or adjusting the volume.

After the setup of a connection between the mobile phone and the Infotainment system, mobile phone data is transmitted to the Infotainment system. This can take several minutes depending on the phone model. During this period, operation of the mobile phone is possible via the Infotainment system only to a limited extent.

#### Note

Not every mobile phone supports all functions of the Phone portal. Therefore deviations from the range of functions described with these specific mobile phones are possible.



### Prerequisites

The following prerequisites must be met in order to use the handsfree mode of the Infotainment system:

- The Bluetooth function of the Infotainment system must be activated ↗ 164.
- The Bluetooth function of the mobile phone must be activated (see user guide of the device).

- The mobile phone must be set to "visible" (see user guide of the device).
- The mobile phone must be paired to the Infotainment system ↗ 164.

### Activating the handsfree mode

Press  /  on the control panel of the Infotainment system. The phone main menu is displayed.

#### Note

If there is no mobile phone connected to the Infotainment system, **No phone available** is displayed. For a detailed description of how to establish a Bluetooth connection ↗ 164.

Many functions of the mobile phone can now be controlled via the phone main menu (and associated submenus) and via the phone-specific controls on the steering wheel.

## Initiating a phone call

### Entering a number manually

With the phone main menu active, press the multifunction knob to open the **Phone Menu**.

Select **Enter number**. The following screen is displayed.



Enter the desired number and select  on the display to start dialling.

#### Note

To open the **Search** screen of the phone book, select .

## Using the phone book

### Note

The phone book may only be downloaded if this function is supported by your mobile phone. For further information, please consult the user guide of your mobile phone.

The phone book contains contact names and numbers.

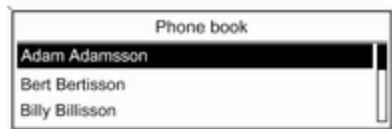

Being in the phone main menu, press the multifunction knob to open the **Phone Menu**.

Select **Phone book**. Select **Search** and then **First Name** or **Last Name**. The following screen is displayed.



As on a telephone or mobile phone, the letters are organised in alphabetical groups on the display: **abc, def, ghi, jkl, mno, pqrs, tuv, and wxyz**.

Select the desired group of letters. The phone book is displayed showing the entries starting with one of the letters in the letter group.

Scroll through the list and select the desired entry name.

Scroll through the list of phone numbers and select the desired number. The corresponding phone number is dialled.

### Deleting the phone book

To delete all entries in the phone book on the Infotainment system, press **↵** / **↵**. Select **Phone book** and then **Delete all**.

### Using the call lists

All incoming, outgoing, or missed calls are registered in corresponding call lists.

With the phone main menu active, press the multifunction knob to open the **Phone Menu**. Select **Call lists**.

The following screen is displayed.



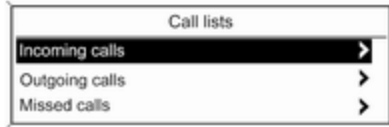

Select the desired call list, e.g. **Missed calls**. A menu with the corresponding call list is displayed.

To initiate a phone call: select the desired list entry. The corresponding phone number is dialled.

### Redialling a phone number

The last dialled phone number can be redialled.

Press **↶** on the steering wheel to open the **Redial** menu.

Press **↶** again to start dialling.

Press **↶** on the steering wheel to exit the **Redial** menu. You may optionally use the multifunction knob to select **No** on the display.

### Incoming phone call

If an audio mode, e.g. the radio or CD mode, is active at the time of an incoming call, the relating audio source will be muted and stay muted until the call ends.

To answer the call: select **Answer** on the display.

To reject the call: select **Decline** on the display.

### Second incoming phone call

If a second phone call comes in during an ongoing call, a message is displayed.

To answer the second call and end the ongoing call: select **Answer** on the display.

To reject the second call and continue the ongoing call: select **Decline** on the display.

### Changing the ring tone

Press **CONFIG** to open the **Settings** menu.

Select **Phone settings, Sound & Signals** and then **Ring tone**. A list of all ring tones available is displayed.

Select the desired ring tone.

For a detailed description of the ring tone volume ↷ 143.

### Functions during a phone call

During an ongoing phone call, the phone main menu is displayed.

Select **Menu** on the display to open the menu **Connected**.

Select **Hang up** on the display to end the call.

### Activating the private mode

In the **Connected** menu, select **Private call** to switch the call to the mobile phone.

To switch the call back to the Infotainment system, select **Menu** on the display and then **Transfer call**.

### Deactivating/activating the microphone

In the **Connected** menu, set **Mute Mic** to **On**. The caller cannot hear you any more.

To reactivate the microphone: set **Mute Mic** to **Off** again.

## Mobile phones and CB radio equipment

### Installation instructions and operating guidelines

The vehicle specific installation instructions and the operating guidelines of the mobile phone and handsfree manufacturer must be observed when installing and operating a mobile telephone. Failure to do so could invalidate the vehicle type approval (EU directive 95/54/EC).

Recommendations for fault-free operation:

- The exterior antenna needs to be professionally installed to obtain the maximum range possible.
- Maximum transmission power: 10 watts.
- The mobile phone needs to be installed in a suitable spot. Consider relevant note in the Owner's Manual, chapter **Airbag system**.

Seek advice on predetermined installation points for the external antenna or equipment holder and ways of using devices with a transmission power exceeding 10 watts.

Use of a handsfree attachment without external antenna with mobile telephone standards GSM 900/1800/1900 and UMTS is only permitted if the maximum transmission power of the mobile telephone is 2 watts for GSM 900 or 1 watt for the other types.

For reasons of safety, do not use the phone while driving. Even use of a handsfree set can be a distraction while driving.

### Warning

Operation of radio equipment and mobile telephones which fail to meet above mentioned mobile telephone standards is only permitted using an antenna located outside of the vehicle.

### Caution

Mobile telephones and radio equipment may lead to malfunctions in the vehicle electronics when operated inside the vehicle with no exterior antenna, unless the above mentioned regulations are observed.



# Index

<b>A</b>		Bluetooth music
Activating Bluetooth music.....	161	Activating.....
Activating CD player.....	155	General information.....
Activating the AUX function.....	157	Operation.....
Activating the handsfree Phone		Prerequisites.....
mode.....	166	
Activating the radio.....	145	<b>C</b>
Activating the USB function.....	159	Call
Autostore lists.....	146	Functions during a call.....
Retrieving stations.....	146	Incoming call.....
Storing stations.....	146	Initiating a phone call.....
Auto volume control.....	143	Ring tone.....
AUX input		Call lists.....
Activating.....	157	Category list.....
Adjusting the volume.....	157	CD menu.....
General information.....	157	CD player
Operation.....	157	Activating.....
		CD menu.....
<b>B</b>		General information.....
Basic operation.....	140	Inserting a CD.....
Blocking out traffic		Removing a CD.....
announcements.....	150	Starting CD playback.....
Bluetooth		Usage.....
Bluetooth connection.....	164	Control elements
Bluetooth music.....	161	Infotainment system.....
Phone.....	166	Phone.....
Bluetooth connection.....	164	Steering wheel.....
		Control elements overview.....

- D**  
 DAB..... 151  
 Date settings..... 139  
 Digital audio broadcasting..... 151  
 Dynamic audio adaption..... 151
- E**  
 Emergency call..... 166
- F**  
 Favourite lists..... 146, 147  
   Retrieving stations..... 146  
   Storing stations..... 146
- G**  
 General information.....  
   ..... 154, 157, 158, 161, 163  
 AUX input..... 157  
 Bluetooth music..... 161  
 CD player..... 154  
 Infotainment system..... 134  
 Phone..... 163  
 USB port..... 158
- I**  
 Infotainment control panel..... 136
- L**  
 Language settings..... 139
- M**  
 Maximum start-up volume..... 143  
 Menu operation..... 140  
 Mobile phones and CB radio  
   equipment ..... 170  
 Multifunction knob..... 140  
 Mute..... 139
- O**  
 Operation..... 161, 166  
   AUX input..... 157  
   Bluetooth music..... 161  
   CD player..... 155  
   Menu..... 140  
   Phone..... 166  
   Radio..... 145  
   USB port..... 159
- P**  
 Phone  
   Activating..... 166  
   Bluetooth..... 163  
   Bluetooth connection..... 164  
   Call lists..... 166  
   Control elements..... 163  
   Dialling a number..... 166  
   Emergency calls..... 166  
   Functions during a call..... 166  
   General information..... 163  
   Important information..... 163  
   Incoming call..... 166  
   Phone book..... 166  
   Prerequisites..... 166  
   Redialling a phone number..... 166  
   Selecting the ring tone..... 166  
 Phone book..... 166  
 Playing saved audio files..... 159
- R**  
 Radio  
   Activating..... 145  
   Autostore lists..... 146  
   Band selection..... 151  
   Category list..... 147  
   Configuring DAB..... 151  
   Configuring RDS..... 150  
   DAB announcements..... 147  
   Digital audio broadcasting  
   (DAB)..... 151  
   Dynamic audio adaption..... 151  
   Favourite lists..... 146, 147  
   Radio data system (RDS)..... 150  
   Radio traffic service..... 150  
   Regionalisation..... 150  
   Retrieving stations..... 146  
   Selecting the waveband..... 145  
   Station lists..... 147  
   Station search..... 145  
   Station tuning..... 145  
   Storing stations..... 146

Traffic announcements.....	150
Updating station lists.....	147
Usage.....	145
Waveband menus.....	147
Radio data system (RDS) .....	150
Radio traffic service.....	150
RDS.....	150
Redial function.....	166
Regionalisation.....	150
Retrieving stations.....	146
Ring tone	
Ring tone volume.....	143
Selecting the ring tone.....	166
<b>S</b>	
Selecting the waveband.....	145
Starting CD playback.....	155
Station lists.....	147
Station search.....	145
Steering wheel audio controls....	136
Storing stations.....	146
Switching the Infotainment system on.....	139
Switching the radio on.....	145
System settings	
Language.....	139
Restore factory settings.....	139
Time and date.....	139
Vehicle settings.....	139

**T**

TA volume.....	143
Theft-deterrent feature .....	135
Time settings.....	139
Tone settings.....	143
Traffic announcements.....	150

**U**

Updating station lists.....	147
Usage.....	139, 145, 155, 157
AUX input.....	157
Bluetooth music.....	161
CD player.....	155
Menu.....	140
Phone.....	166
Radio.....	145
USB port.....	159
USB menu.....	159
USB port	
Activation.....	159
Connecting the USB device....	158
General information.....	158
Important information.....	158
Operation.....	159
Removing the USB device.....	159
USB menu.....	159

**V**

Volume	
Auto volume control.....	143
Maximum start-up volume.....	143
Mute function.....	139
Ring tone volume.....	143
Setting the volume.....	139
Speed compensated volume. .	143
TA volume.....	143
Volume limitation at high temperatures.....	139
Volume settings.....	143

**W**

Waveband menus.....	147
---------------------	-----

[www.opel.com](http://www.opel.com)

Copyright by ADAM OPEL AG, Rüsselsheim, Germany.

The information contained in this publication is effective as of the date indicated below. Adam Opel AG reserves the right to make changes to the technical specifications, features and design of the vehicles relative to the information in this publication as well as changes to the publication itself.

Edition: March 2015, ADAM OPEL AG, Rüsselsheim.

Printed on chlorine-free bleached paper.

**KTA-2723/7-en**

**03/2015**

