

THE NEW VIVARO



THE VAN WHICH DOES MORE.

Introducing the new Vivaro, the van engineered to go above and beyond expectations. With three versatile body styles – the regular van, Crew Van and Combi – you'll find the perfect Vivaro for you, whatever the nature of your business. Are you ready to demand more of your van?









THE NEW STANDARD.

The Vivaro has been designed from the ground-up to become the most competitive commercial vehicle in its segment. Enjoy a highly flexible load space, class-leading payload, mobile office functionality and various connectivity features – all in the name of driving your business forward.

- 1** The Vivaro marries striking Opel design with German engineering precision.
- 2** The new Vivaro possesses superior, car-like driving behaviour, plus state-of-the-art technology rarely found in commercial vehicles.
- 3** Highly efficient engines and transmissions ensure class-leading cost of ownership.
- 4** Choose between three body styles to find the right Vivaro for your business needs.
- 5** Tailor your space with two different body lengths.
- 6** Create a mobile office space with an adjustable office table¹ and smartphone/tablet holders¹.
- 7** Enjoy an impressively useful maximum load volume of up to 6.6m³⁽²⁾ and a payload of up to 1,400kg.
- 8** Driver assistance systems like Automatic Cruise Control³, Traffic Sign Recognition and Automatic Emergency Braking³ provide superior driving control and safety.

¹Standard on Sportive, optional on Edition models.

²L2 model including FlexCargo® with seat folded up.

³Please refer to back page of catalogue.

DESIGN WITH PURPOSE.

Meet the clever features and practical solutions that make every working day in Vivaro easier.

Twin sliding side-access doors as standard give you easy access to the load area, as well as the option to add electric hands-free opening. A clever feature that brings innovation to the class.

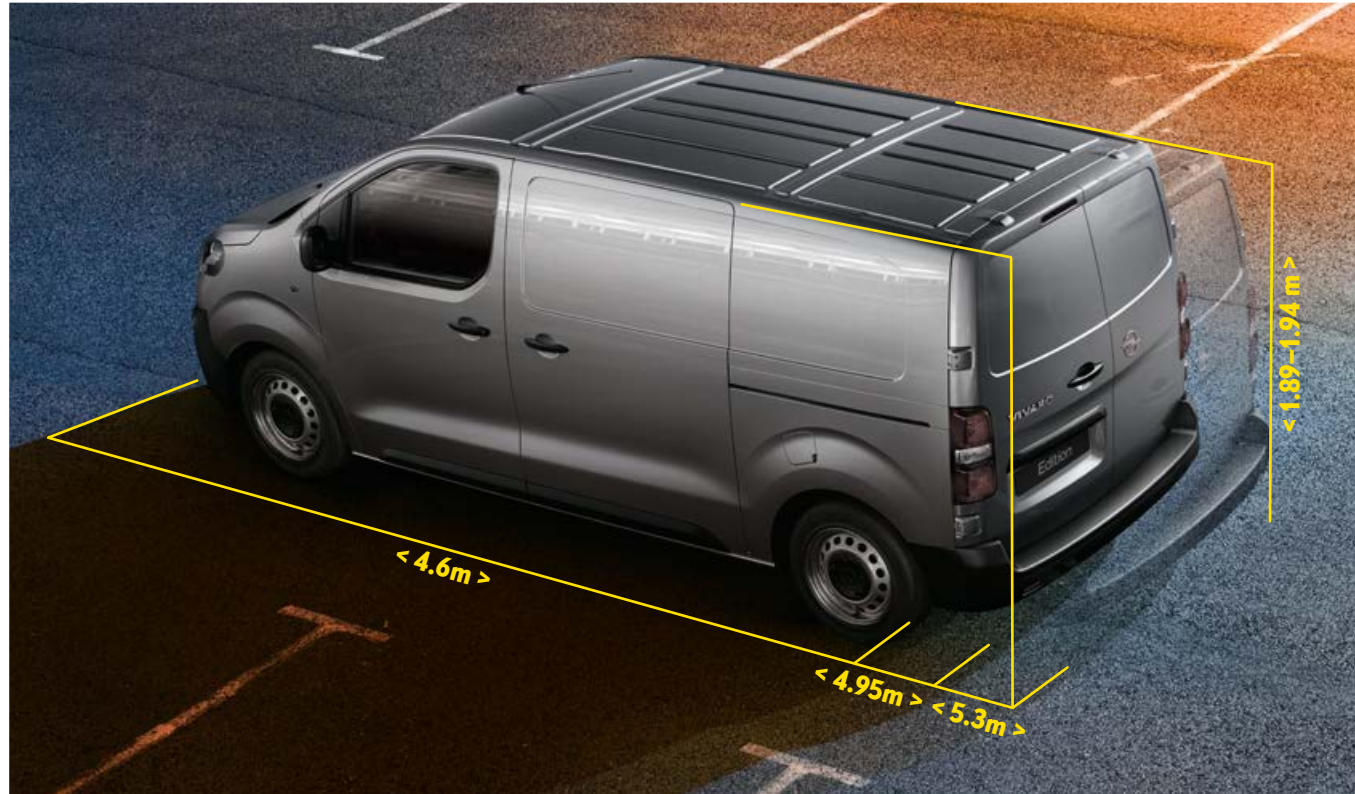





COMPACT AND AGILE.

	L1	L2
LOAD AREA DIMENSIONS (mm)		
Max. floor load length (without FlexCargo®)	2,512	2,862
Max. floor load length (with FlexCargo®)	3,674	4,024
Mid-height load length	2,185	2,535
Load floor width between wheel arches	1,258	1,258
Max. load width	1,636	1,636
Max. load height	1,397	1,397
LOADING VOLUME (m³)		
Commercial volume without FlexCargo®	5.3	6.1
Commercial volume with FlexCargo®	5.8	6.6
Number of euro-pallets	2	3
REAR OPENING DIMENSIONS (mm)		
Min. threshold height	544	600
Max. threshold height	613	633
Max. opening width	1,282	1,282
Rear doors opening height	1,220	1,220
SLIDING DOOR OPENING DIMENSIONS (mm)		
Max. opening width	935	935
Sliding side door opening height	1,241	1,241
MANOEUVRABILITY (m)		
Turning circle between kerbs	12.4	12.4
Turning circle between walls	12.9	12.9

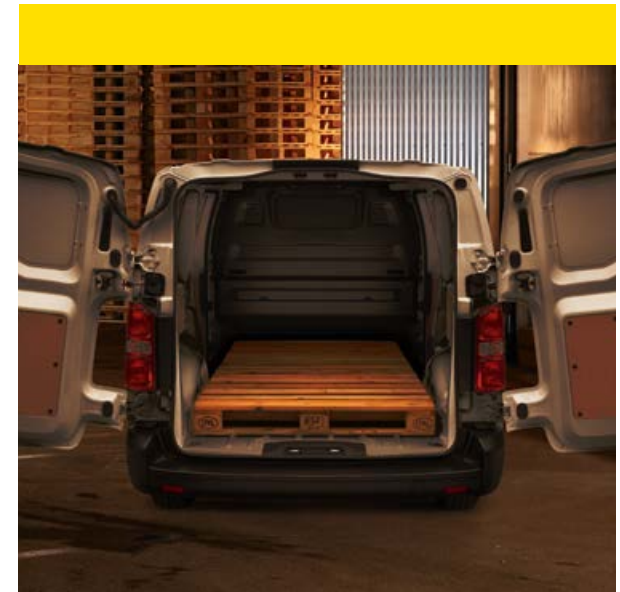

Available in two sizes of body length – L1 and L2 – the new Vivaro perfectly adapts to your business needs, each variant offering a balance between relatively compact exterior dimensions and a spacious, flexible interior. L1 models can carry two euro-pallets, while the larger L2 model can comfortably carry three.

CLEVER PACKAGING.

Despite its relatively compact exterior dimensions, the Vivaro's clever interior packaging and innovative FlexCargo® passenger bench¹ create a highly competitive load volume (up to 6.6m²) and load length (up to 4m).

Payload: cut down on journeys by carrying more each time, thanks to the Vivaro's generous maximum payload of 1,400kg.

FlexCargo® load-through function¹: seat three comfortably up front or fold up the outer front passenger seat and use the partition wall flap to maximise the Vivaro's continuous, flat loading area when carrying longer cargo.

Cabin: fold the base of the outer front passenger seat up against the seat back to load bulky cargo such as large boxes into the front of the van.¹

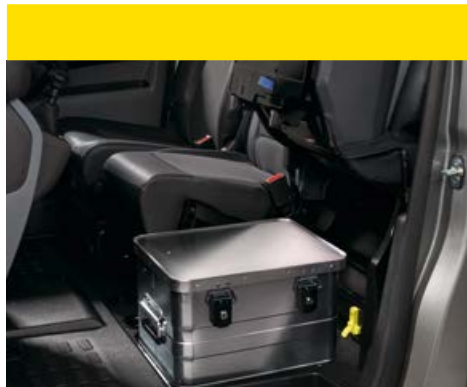
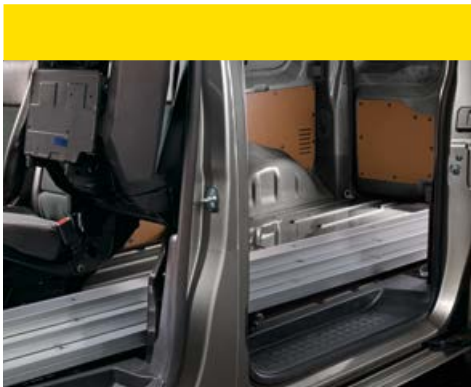

¹Standard on Sportive, optional on Edition models.

²L2 models include FlexCargo® with seat folded up.





SPACE FOR THE CREW.

Sportive models – fixed bulkhead with rear bench: enjoy a load volume of 3.2–4.0m³ behind the second row of seats.

Need your van to offer even greater seating flexibility? With space for up to six, the Vivaro Doublecab is the ultimate solution, allowing you to move both people and cargo without compromise.

Edition models – foldable rear bench with integrated steel mesh bulkhead: a generous load volume of up to 4.0m³ (rear bench upright) can be expanded to 5.5m³ (bench folded up), extending the maximum load length by an extra 60cm¹ by folding the bench and partition.

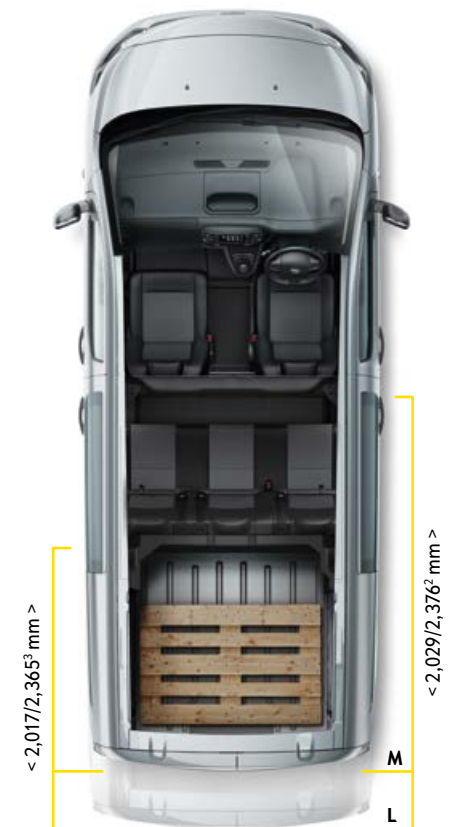

¹At mid-height.
²Foldable Doublecab with folded bench.
³Fixed Doublecab.

Load space: an impressive load length (on floor) of up to 2.36m and a maximum load height of 1.39m.

EVERYTHING YOU NEED.

Thanks to its clever interior packaging, the Vivaro Combi can comfortably seat up to nine people. Tinted rear windows, dual sliding doors and flexible seating configurations¹ make it the ideal taxi or agile people mover for your team. In the front, choose from an individual passenger seat or bench for two. In the second row, choose a 3-seater bench¹ or 2-seater bench with individual folding third seat¹. In the third row, again choose a 3-seater bench¹ or maximise flexibility with an individual third seat¹ for loading longer items alongside several passengers.

¹Optional.



5-seater with two single seats in the front and 2-seater bench and one single seat in the second row.



6-seater with one single seat and 2-seater bench in the front and in the second row.



8-seater with two single seats in the front, 2-seater bench and one single seat in the second and third row.



8-seater with two single seats in the front, 2-seater bench and one single seat in the second and third row, pulled down.

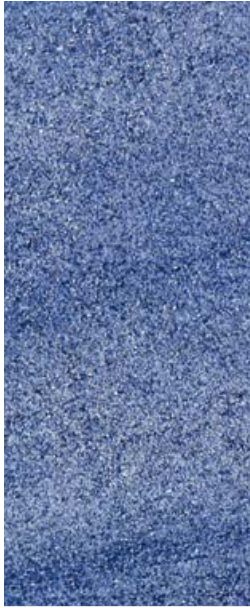





CLASS-LEADING INNOVATION.

Stay connected on the road with smart technology and security systems. Helpful features such as emergency call, breakdown call with access to Roadside Assistance will be available in the course of 2019.¹



Navigation system: the navigation system includes an impressive 7-inch touch screen² and 3-D navigation to keep you on track during everyday drives or longer hauls.



Opel Connect: stay connected on the road with smart technology systems, security systems and driver innovations including eCall with emergency crash response. More helpful features such as Roadside Assistance and vehicle status and information will be available towards the end of the year.

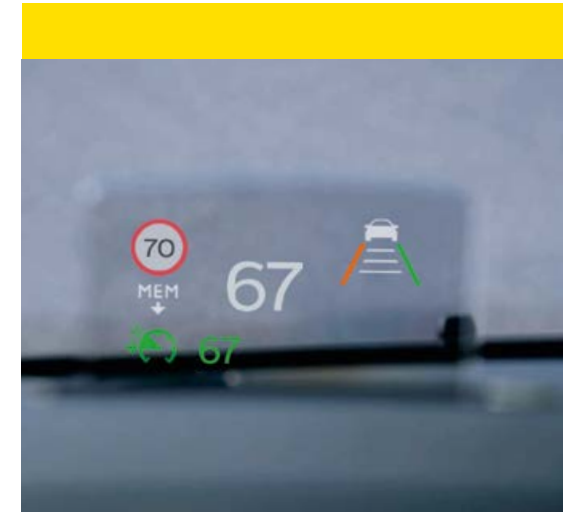

Head-up Display: unique in the segment, see vital info such as speed and cruise control data projected in the driver's line of sight on the Head-up Display².

¹Emergency and breakdown call availability as an option in vehicles, plus further Opel Connect Services, expected from Autumn 2019. Services might require a subscription/fee and are subject to mobile network coverage and availability.

²Optional.

YOUR OFFICE ON THE GO.

Whatever the nature of your business, having the ability to turn your van into a mobile office is essential. The Vivaro offers an adjustable office table¹, a smartphone/tablet holder¹ and a variety of other practical storage solutions throughout the cabin and dashboard, so that every object has its own place, keeping you organised and your business on track – day in, day out.



Passenger bench with integrated storage¹: enjoy additional storage volume underneath the passenger bench¹ cushions, so you can stow work equipment and other valuable objects up to a volume of 60 litres.



Dashboard storage: lots of smaller items to stow? With open storage boxes in the dashboard and a glove box with cooling function, the Vivaro has you covered.



Door pockets: wells in the pockets of the driver's and front passenger door are perfect for holding large items like 1.5-litre bottles.

¹Optional.





SEATS TO RELAX IN.

Enjoy a high degree of comfort in the Vivaro's spacious cabin, with seats designed for perfect ergonomic support even across the longest of journeys and available in a variety of attractive trims. Heated seats¹ in the front row are there to keep you warm when the weather gets cold.

¹Standard on Panel Van models.

²Standard on Combi models.

³Standard on Doublecab Edition models.

⁴Standard on Doublecab Sportive models.

1 Curitiba Triton, Grey fabric/Carla, Black vinyl seats¹

2 Curitiba Monotone, Light Grey fabric seats²

3 Carla, Black full-vinyl seats³

4 Curitiba Triton, Grey fabric seats⁴

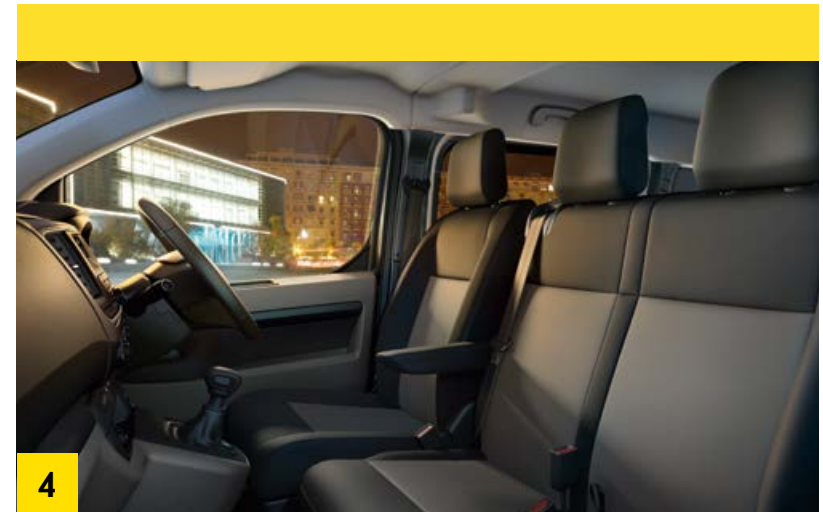
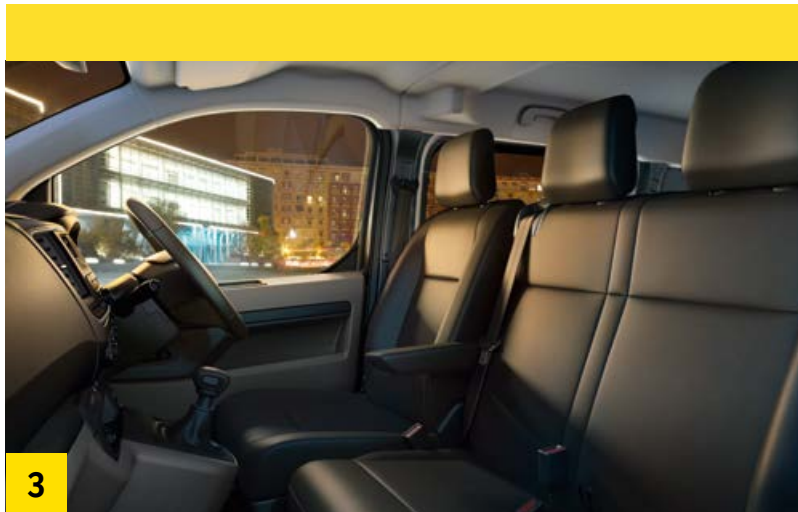

YOU'RE IN GOOD HANDS.

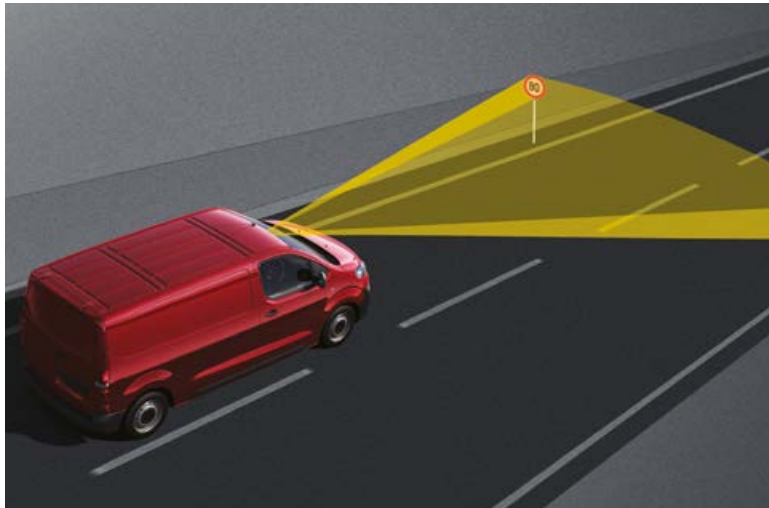

Speed Limit Adaptation¹: uses Speed Sign Recognition to analyse changes in the speed limit. With one push of the memory button, allow cruise control to adjust your speed accordingly.

Smart Beam¹: switches the headlamps between high beam and dipped beam automatically to avoid blinding other drivers.

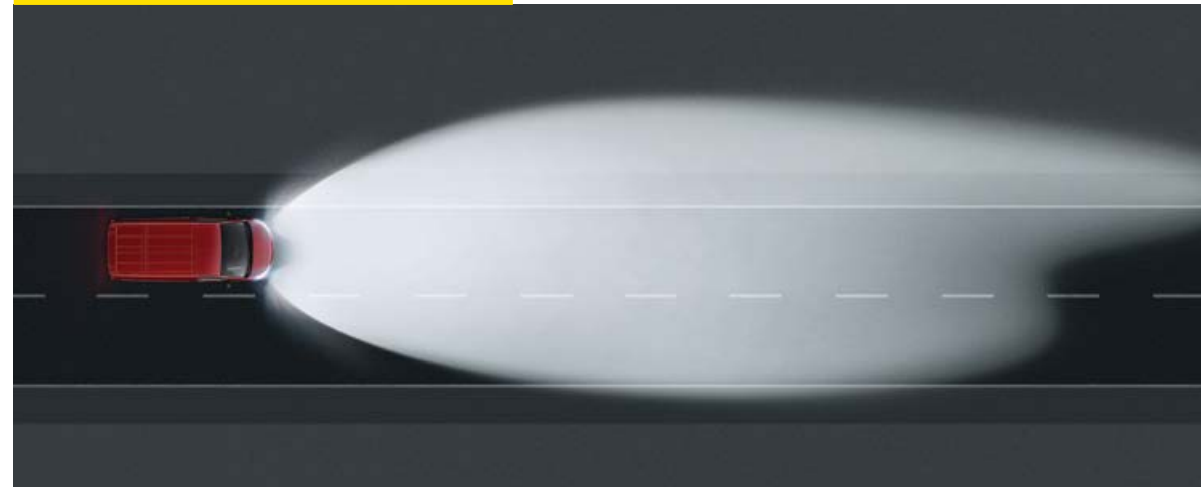

¹Optional.

Driver Drowsiness Alert!: analyses your driving patterns via the front camera and steering wheel movements to let you know when it's time to take a quick break.



Lane Departure Warning!: recognises when the Vivaro is drifting lanes and alerts the driver via audio and visual cue.

Automatic Emergency Braking^{1,2}: takes action to avoid an accident, applying the brakes automatically in case of potential collision.



Forward Collision Alert¹: scans the road ahead to alert the driver to the potential for a collision with the vehicles in front.

¹Optional.

²Please refer to back of catalogue.

ENGINEERED TO HELP YOU OUT.

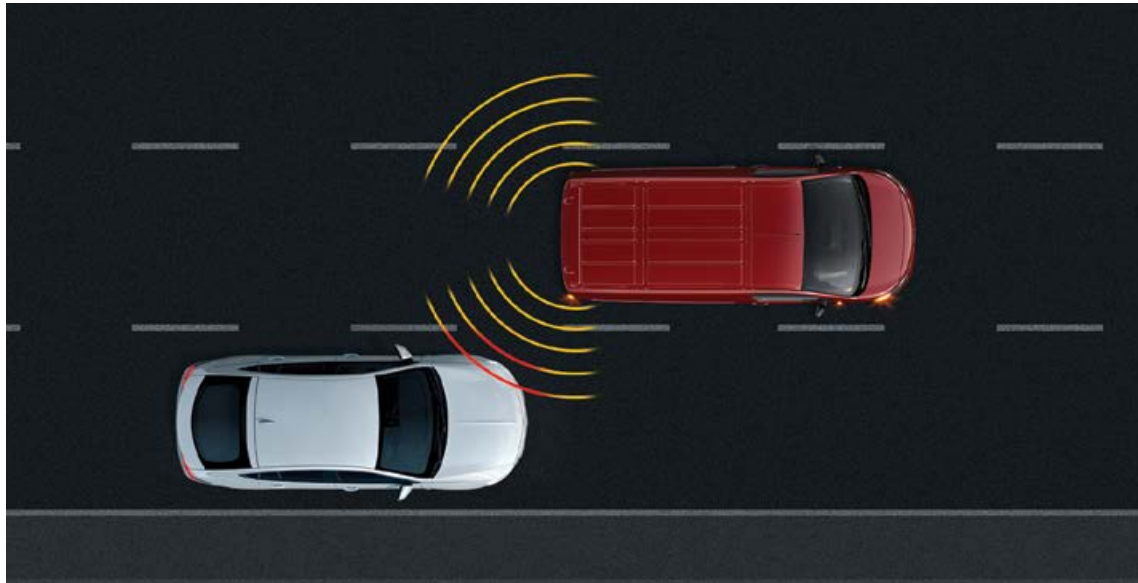

Side Blind Spot Alert: uses sensors and a visual projection on the wing mirror, alerting the driver to vehicles in the Vivaro's blind spot to prevent accidents in overtaking situations.

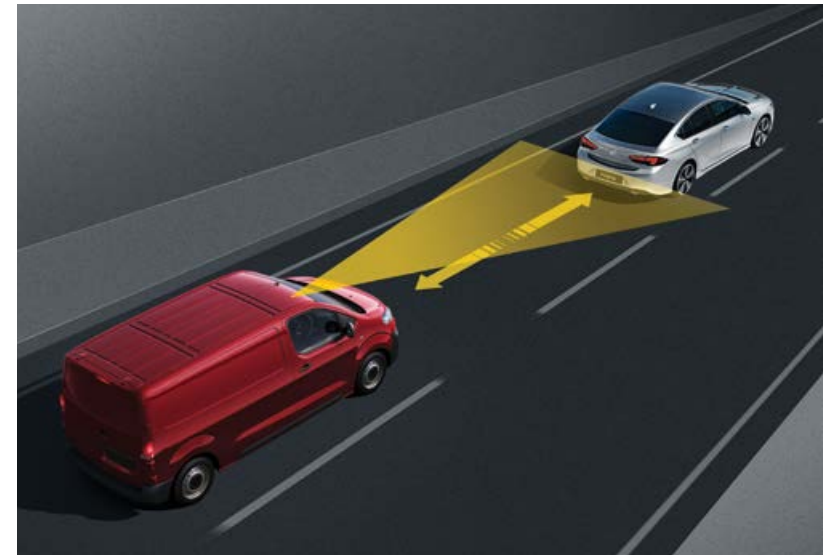

Automatic Cruise Control: lowers your speed to maintain a set distance from the car ahead in traffic scenarios, and restores your previous speed when the road clears.

CHALLENGING SURFACES WELCOME.





Eight-speed Auto¹: a smooth and ultra-efficient eight-speed auto will take you further for less



IntelliGrip¹: the Vivaro's IntelliGrip system, including special construction site tyres, provides extra levels of traction on difficult surfaces such as mud, sand or snow.

With the Vivaro's Worksite Pack, suspension is raised by 25mm for those occasions when extra ground clearance is required. Also included are an increased payload and an under-engine cover plate to prevent damage from rough surfaces. In bad weather and on challenging surfaces, IntelliGrip¹ or 4x4 conversion¹ provide even greater grip.

Fuel consumption: go further on a single tank with the Vivaro's range of powerful yet frugal engines and smooth transmissions, for low running costs, reduced emissions and maximum efficiency. For complete technical data, fuel economy and emissions, please see the New Vivaro Price and Specification Guide, available to download from opel.ie

¹Optional.

FIND THE PERFECT FINISH.

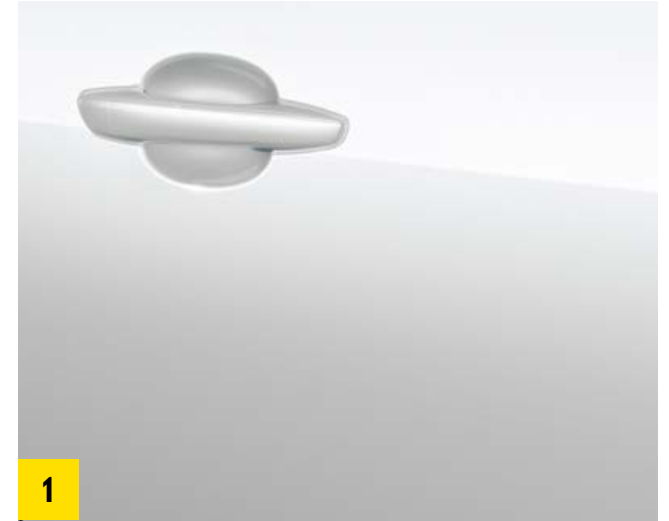



- 1** Jade White
- 2** Flaming Red¹
- 3** Diamond Black²
- 4** Quartz Grey Metallic²
- 5** Moonstone Grey Metallic²
- 6** Cool Grey Metallic²
- 7** Rich Oak Brown Metallic²
- 8** Amber Red Metallic²

¹Edition models only.

²No-cost option for Sportive models, optional at extra cost for Edition models.

SPECIAL EQUIPMENT ACCESSORIES.

Take your van's practicality to the next level with our range of genuine accessories.



- 1** Roof bars¹
- 2** Wind deflectors¹
- 3** Load compartment protection kit/floors¹
- 4** Roof racks¹
- 5** Floor mats¹
- 6** Towing hitch with ball mount¹
- 7** Towing hitch with ball and pintle mount¹

¹Optional.

When it comes to servicing and maintenance, Opel's expert repair network provides fast, convenient and great value after-sales care – getting your car or commercial vehicle back on the road quickly. Opel has the specialised equipment, tools and training to support all of your after-sales needs, using only genuine parts fitted by Opel trained technicians. Simply put, we are your 'one-stop shop' for all after-sales support under one roof.

OPEL SERVICE.



SERVICE

OPEL IS YOUR SERVICE PROFESSIONAL

- Powerful and nationwide service network
- Comprehensive service plans
- Over 30 Opel authorised repairs
- New commercial vehicle warranty of 3 years/150,000km
- 12 year anti-perforation warranty
- Roadside assistance for 12 months

MYOPEL

CUSTOMISED PROTECTION

MyOpel is a Service Club that brings all the advantages of Opel Genuine Service to the internet!

Register now on MyOpel.ie and benefit from the following features:

- Up to 25% discount on parts and labour
- Free 25-point health check for every Service Club customer
- Maximise your Opel's performance – we'll remind you when your car is due for its annual service or NCT test
- Find the dealership nearest to you with our dealer locator
- Send online requests and get your appointments quick and easy



OPEL PROFESSIONAL MAINTENANCE

OPEL COMPETENCE

Opel specialists know your car better than anyone else and provide quick, convenient and expert service at a fair price.

- NCT and pre-NCT checks
- Service inspections
- Oil check
- Summer/Winter check
- Tyre change



OPEL ORIGINAL PARTS

ALWAYS YOUR BEST OPTION

Opel original parts are fully tested for function and safety, fit perfectly and are the most reliable parts available for your car.

- Opel original batteries are maintenance-free and carry a 2 year warranty
- Opel original wiper blades minimise wind and noise and improve high-speed comfort
- Opel original brake discs are made for the best braking performance and shortest braking distances
- Opel original bumpers are crash tested and fit properly, so your vehicle retains its original look



ELECTRONIC VEHICLE HEALTH CHECK

GET YOUR PEACE OF MIND WITH OUR FREE VISUAL CHECK

We visually check 97 safety and reliability aspects of your car – in less than 15 minutes. You decide what is repaired and when. By proactively handling small repairs, you can avoid costly repairs later on.

- Free of charge
- Covers all main safety aspects
- Immediate feedback
- Report for your records



NAVIGATION MAP UPDATES

DRIVE SMARTER

Good navigation demands up-to-date maps. Opel navigation updates provide the latest maps and info with thousands of route updates – so you can reach your destination.

- Save time by driving efficiently
- Save money – on both fuel and vehicle maintenance
- Respect the environment – reduce fuel consumption and CO₂ emissions

Find out more at your local dealership!

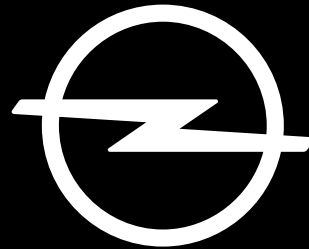

THE FUTURE IS EVERYONE'S

Some feature descriptions in this brochure may refer to, and some illustrations may show, optional equipment not included in the standard delivery. The information contained in this brochure was accurate at the time of publication. We reserve the right to make changes in design and equipment. The colours illustrated in the brochure only approximate actual colours. Illustrated optional equipment is available at extra charge. Availability, technical features and equipment provided on our vehicles can vary by model. For precise information on the equipment provided on our vehicles, please contact your local Opel dealer.

Automatic Emergency Braking with Pedestrian Detection works automatically above 5km/h and below 85km/h. From 0 to 30km/h, the deceleration metric to reduce the impact speed of the collision is 0.9g. From 30 to 85km/h, the system reduces the speed by a maximum of 22km/h. After this threshold, the driver needs to brake him-/herself to reduce the speed even further. Operational speed range of Automatic Emergency Braking with Pedestrian Detection depends on the detected obstacle (mobile obstacle: from 5 to 85km/h; fixed obstacle: from 5 to 80km/h; pedestrian: from 5 to 60km/h).

Opel driver assistance systems are intended to support the driver within the system-immanent limitations. The driver remains responsible for the driving task.