Contents

Introduction	2
In brief	6
Keys, doors and windows	19
Seats, restraints	28
Storage	43
Instruments and controls	50
Lighting	65
Infotainment system	69
Climate control	78
Driving and operating	82
Vehicle care	94
Service and maintenance	123
Technical data	130
Index	136

Introduction

Fuel	Designation	<input type="text"/>		
Engine oil	Grade	<input type="text"/>		
	Viscosity	<input type="text"/>		
Tyre pressure		Tyre size	Front	Rear
	Summer tyres	<input type="text"/>	<input type="text"/>	<input type="text"/>
	Winter tyres	<input type="text"/>	<input type="text"/>	<input type="text"/>
Weights		Gross vehicle weight rating		
		- Kerb weight, basic model		
		= Loading		

Vehicle specific data

Please enter your vehicle's data on the previous page to keep it easily accessible. This information is available under the sections "Service and maintenance" and "Technical data" as well as on the identification plate.

Introduction

Your vehicle is a designed combination of advanced technology, safety, environmental friendliness and economy.

This Owner's Manual provides you with all the necessary information to enable you to drive your vehicle safely and efficiently.

Make sure your passengers are aware of the possible risk of accident and injury which may result from improper use of the vehicle.

You must always comply with the specific laws and regulations of the country that you are in. These laws may differ from the information in this Owner's Manual.

When this Owner's Manual refers to a workshop visit, we recommend your Opel Service Partner.

All Opel Service Partners provide first-class service at reasonable prices. Experienced mechanics trained by Opel work according to specific Opel instructions.

The customer literature pack should always be kept ready to hand in the vehicle.

Using this manual

- The "In brief" section will give you an initial overview.
- The table of contents at the beginning of this manual and within each chapter shows where the information is located.
- The index will enable you to search for specific information.
- This Owner's Manual depicts left-hand drive vehicles. Operation is similar for right-hand drive vehicles.

- The Owner's Manual uses the factory engine designations. The corresponding sales designations can be found in the chapter "Technical data".
- Directional data, e.g. left or right, or front or back, always relate to the direction of travel.
- Depending on the model variant, country variant, integrated special equipment and accessories, the scope of equipment of your vehicle can differ from the descriptions in this Owner's Manual.

Danger, Warnings and Cautions

Danger

Text marked  **Danger** provides information on risk of fatal injury. Disregarding this information may endanger life.

⚠ Warning

Text marked **⚠ Warning** provides information on risk of accident or injury. Disregarding this information may lead to injury.

Caution

Text marked **Caution** provides information on possible damage to the vehicle. Disregarding this information may lead to vehicle damage.

Symbols

Page references are indicated with ↗. ↗ means "see page".

We wish you many hours of pleasurable driving.

Adam Opel GmbH

In brief

Initial drive information

Vehicle unlocking

Unlocking with key

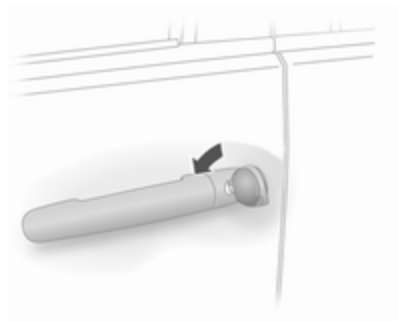

Turn the key in the driver's door lock to the front. The tailgate is unlocked when the driver's door is opened.

Unlocking with radio remote control



Press button  to unlock the doors and load compartment. Open the doors by pulling the handles, to open the tailgate, press the button under the handle.

Radio remote control ⇨ 19, Central locking system ⇨ 20, Load compartment ⇨ 22.

Seat adjustment

Seat positioning



Pull handle, slide seat, release handle.

Seat adjustment ⇨ 29, Seat position ⇨ 29.

⚠ Danger

Do not sit nearer than 25 cm (10 inches) from the steering wheel, to permit safe airbag deployment.

Seat backrests



Pull lever, adjust inclination and release lever. Allow the seat to engage audibly. Do not lean on backrest when adjusting.

Seat adjustment ⇨ 29, Seat position ⇨ 29.

Seat height



Lever pumping motion

up: = higher
down: = lower

Seats ⇨ 29, Seat position ⇨ 29.

Head restraint adjustment



Press release button, adjust height, engage.

Head restraints ⇨ 28.

Seat belt



Pull out the seat belt and engage in belt buckle. The seat belt must not be twisted and must fit close against the body. The backrest must not be tilted back too far (maximum approx. 25°).

To release belt, press red button on belt buckle.

Seat belts ⇨ 31, Airbag system ⇨ 33, Seat position ⇨ 29.

Mirror adjustment

Interior mirror



Turn the lever on the underside to reduce dazzle.

Interior mirror ⇨ 26.

Exterior mirrors



Swivel lever in required direction.
Exterior mirrors ⇨ 24.



Select the relevant exterior mirror and adjust.

Electric adjustment ⇨ 25, Convex exterior mirrors ⇨ 24, Folding exterior mirrors ⇨ 25, Heated exterior mirrors ⇨ 25.

Steering wheel adjustment

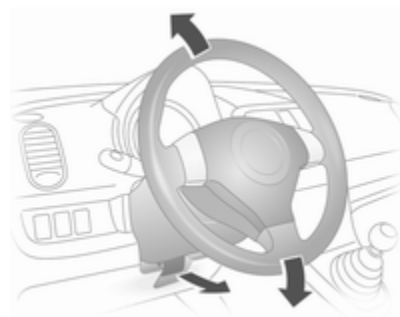

Unlock lever, adjust steering wheel, then engage lever and ensure it is fully locked. Do not adjust steering wheel unless vehicle is stationary and steering wheel lock has been released.

Airbag system ⇨ 33, Ignition positions ⇨ 83.

Instrument panel overview

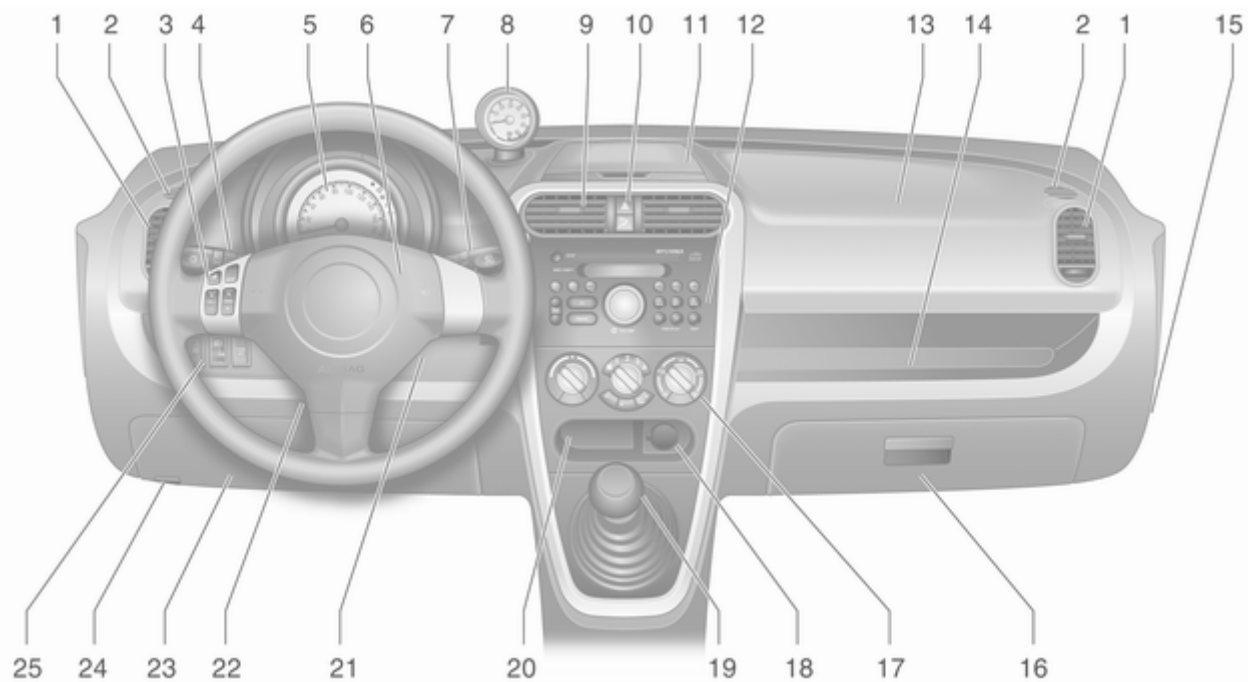

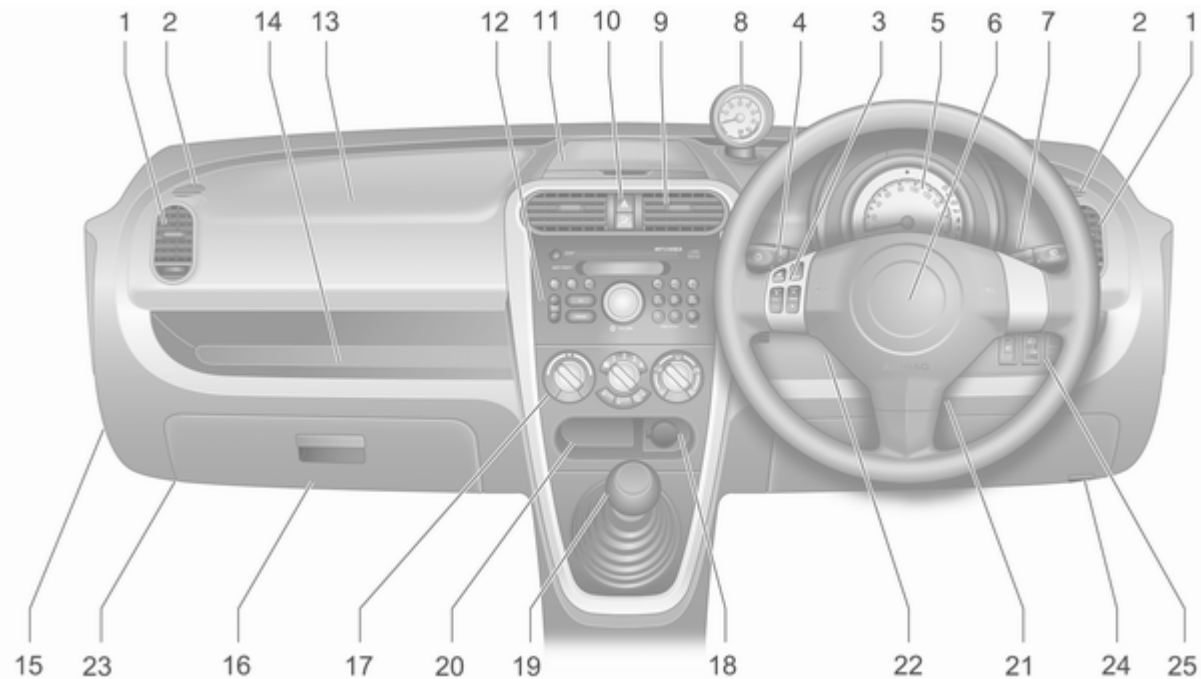

1	Side air vents	80	15	Airbag deactivation	37
2	Door window defroster vents	80	16	Glovebox	44
3	Remote control for infotainment system	50	17	Climate control system	78
4	Turn signals, headlight flash, low beam and high beam	67	18	Power outlet	53
	Rear fog light	67		Cigarette lighter	53
5	Instruments	54	19	Selector lever, manual transmission	88
6	Driver airbag	34		Automatic transmission	86
	Horn	51	20	Storage tray	43
7	Windscreen wiper, windscreen washer system	51	21	Ignition switch with steering wheel lock	83
	Rear window wiper/washer ...	52	22	Steering wheel adjustment ...	50
8	Tachometer	55	23	Fuse box	107
9	Centre air vents	80	24	Bonnet release lever	95
10	Hazard warning flashers	66	25	Headlight range adjustment	66
	Control indicator for airbag deactivation	58		Front fog lights	67
11	Upper tray	43		Traction Control system	90
12	Infotainment system	72			
13	Front passenger airbag	34			
14	Storage tray	43			



Exterior lighting



Turn

-  = sidelights
-  = headlights
- OFF = off

Turn

-  = rear fog light
- OFF = off

Lighting ⇨ 65.

Front fog lights



Operated with the  button.

Front fog lights will only operate when the headlights or sidelights are switched on.

Headlight flash, high beam and low beam

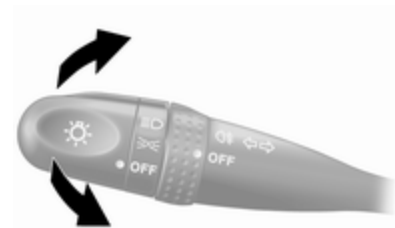

- headlight flash = pull lever
- high beam = push lever
- low beam = pull lever

High beam ⇨ 65, Headlight flash ⇨ 65.

Turn and lane-change signals

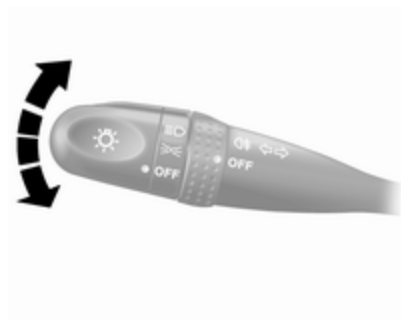

right = lever up
left = lever down

Turn and lane-change signals
↪ 67.

Hazard warning flashers



Operated with the  button.
Hazard warning flashers ↪ 66.

Horn



Press .

Washer and wiper systems

Windscreen wipers



MIST = misting function

OFF = off

INT = adjustable timed interval
wipe

LO = slow

HI = fast

For a single swipe, move lever up
from position **OFF**.

Windscreen wipers ⇨ 51, Wiper
blade replacement ⇨ 99.

Windscreen and headlight washer systems

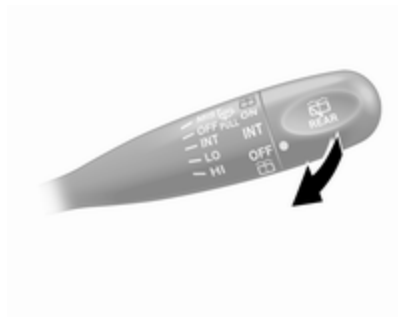

Pull lever.

Windscreen and headlight washer
system ⇨ 51, Washer fluid ⇨ 98.

Rear window wiper and washer system



Turn

 = washer fluid is sprayed onto
the rear window

OFF = off

INT = intermittent operation

ON = continuous operation

 = washer fluid is sprayed onto
the rear window

Climate control



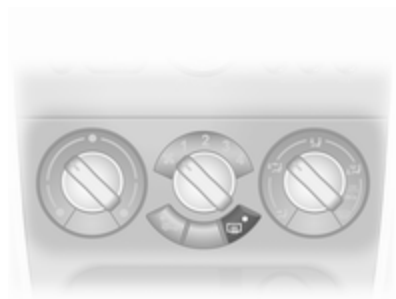

Heated rear window, heated exterior mirrors

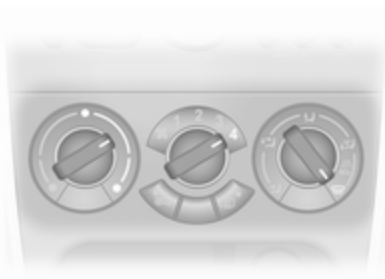

Operated with the  button.
Heated rear window ⇨ 27, Heated exterior mirrors ⇨ 25.

Demisting and defrosting the windows



Turn air recirculation mode  off.
Set temperature control to warmest level.
Cooling  on.
Set air distribution control to .
Set fan to **4**.
Heated rear window  on.
Climate control system ⇨ 78.

Transmission

Manual transmission



Reverse: with the vehicle stationary, wait 3 seconds after depressing clutch pedal and engage the gear.
If the gear does not engage, set the lever in neutral, release the clutch pedal and depress again; then repeat gear selection.
Manual transmission ⇨ 88.

Automatic transmission

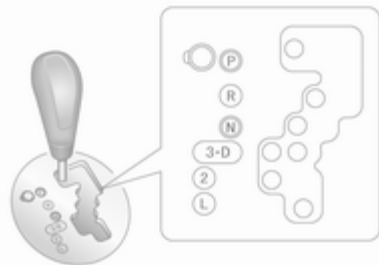

- P** = park
R = reverse
N = neutral
D = drive

The selector lever can only be moved out of **P** when the ignition is on and the brake pedal is applied.

Automatic transmission ⇨ 86.

Starting off

Check before starting off

- Tyre pressure and condition
⇨ 109, ⇨ 135.
- Engine oil level and fluid levels
⇨ 96.
- All windows, mirrors, exterior lighting and number plates are free from dirt, snow and ice and are operational.
- Proper position of mirrors, seats and seat belts ⇨ 25, ⇨ 29, ⇨ 32.
- Brake function at low speed, particularly if the brakes are wet.

Starting the engine



Turn key to position **ACC**. Move the steering wheel slightly to release the steering wheel lock. Operate clutch and brake, automatic transmission in **N** or **P**, do not accelerate; for diesel engines, turn the key to position **ON** for preheating and wait until control indicator  goes out; turn key to **START** and release key.

Starting the engine ⇨ 83.

Parking

- Always apply parking brake without pressing release button. Apply as firmly as possible on a downhill slope or uphill slope. Operate foot brake at same time to reduce operating force.
- Switch off the engine and ignition. Push key into ignition lock, turn to **LOCK** and remove. Turn the steering wheel until the steering wheel lock is felt to engage.

For vehicles with automatic transmission, the key can only be removed when the selector lever is in the **P**.

- If the vehicle is on a level surface or uphill slope, engage first gear or set the selector lever to **P** before switching off the ignition. On an uphill slope, turn the front wheels away from the kerb.

If the vehicle is on a downhill slope, engage reverse gear or set the selector lever to **P** before switching off the ignition. Turn the front wheels towards the kerb.

- Lock the vehicle with button  on the radio remote control. Activate the anti-theft locking system ⇨ 23.
- Do not park the vehicle on an easily ignitable surface. The high temperature of the exhaust system could ignite the surface.
- Close windows.
- The engine cooling fans may run after the engine has been switched off ⇨ 95.
- After running at high engine speeds or with high engine loads, operate the engine briefly at a low load or run in neutral for approx. 30 seconds, before switching off in order to protect the turbocharger.

Keys, locks ⇨ 19, Laying the vehicle up for a long period of time ⇨ 94.

Keys, doors and windows

Keys, locks	19
Doors	22
Vehicle security	23
Exterior mirrors	24
Interior mirrors	26
Windows	26

Keys, locks

Keys

Replacement keys

The key number is specified on the key or on a detachable tag.

The key number must be quoted when ordering replacement keys as it is a component of the immobiliser system.

Locks ⇨ 121.

Radio remote control



Used to operate:

- Central locking system
- Anti-theft locking system

The radio remote control has a range of approx. 5 metres (16 ft). This range can be affected by outside influences. The hazard warning flashers confirm operation.

Handle with care, protect from moisture and high temperatures and avoid unnecessary operation.

Fault

If the central locking system cannot be operated with the radio remote control, it may be due to the following:

- Range exceeded
- Battery voltage too low
- Interference from higher-power radio waves from other sources

Opening the vehicle ⇨ 20.

Radio remote control battery replacement



Replace the battery as soon as the range reduces.

Remove screw on key cover and remove the transmitter. Prise apart both halves of transmitter with a suitable screwdriver.

Batteries do not belong in household waste. They must be disposed of at an appropriate recycling collection point.

Replace the battery (battery type CR 1620), paying attention to the installation position.

Reattach both halves of transmitter and reinstall in holder, ensuring it engages correctly.

Replace cover and tighten screw.

Central locking system

Unlocks and locks doors and tailgate.

Unlocking

Central locking system with key activation

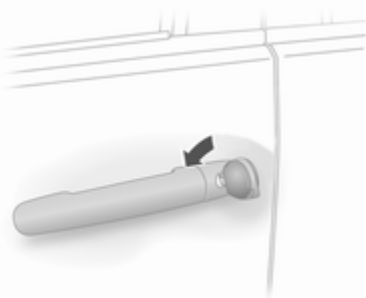



Turn the key in the driver's door lock to the front. The tailgate is unlocked when the driver's door is opened.

The entire vehicle can be unlocked by turning the key twice in the driver's door lock.

Central locking system with radio remote control



Press button .

Configured to unlock only the driver's door by pressing button  once and to unlock all doors and tailgate by pressing button  twice.

If no door is opened within approx. 30 seconds after the vehicle has been unlocked via the remote control, the vehicle is relocked automatically.

Locking

Close doors and tailgate.

Central locking system with key activation

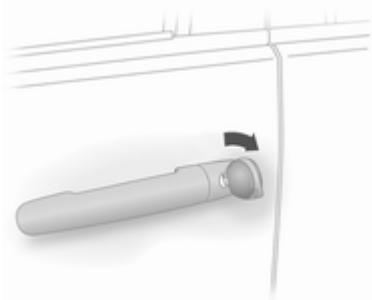

Turn the key in the driver's door lock to the rear.

Central locking system with radio remote control



Press button .

Central locking button

Locks or unlocks all doors and the tailgate.



Press button .

front = lock

rear = unlock

Interior lock

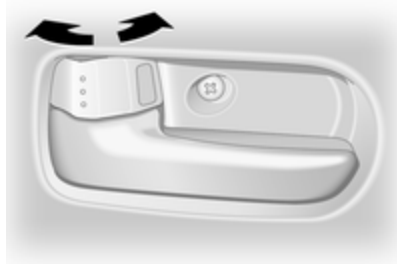

Locks or unlocks the doors from inside the vehicle.

To lock front doors from outside the vehicle, press the interior lock and keep exterior door handle raised when closing the door.

Child locks

**⚠ Warning**

Use the child locks whenever children are occupying the rear seats.

To engage lock, open door and move lock lever to lower position. Door cannot then be opened from inside.

To disengage safety lock, raise lock lever.

Doors

Load compartment
Opening

Press the button below the handle and lift the tailgate.

⚠ Warning

Do not drive with the tailgate open or ajar, e.g. when transporting bulky objects, since toxic exhaust gases could enter the vehicle.

Note

The installation of certain heavy accessories onto the tailgate may affect its ability to remain open.

If the tailgate is open when the ignition is switched on, control indicator  illuminates in the instrument cluster.

Central locking system ⇨ 20.

Closing

Use the interior handle.

Close tailgate by pushing it down so it latches securely. Ensure tailgate is fully closed before driving.

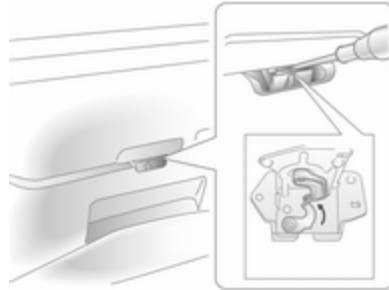
Emergency tailgate release

If the central locking system cannot be operated with the remote control, the tailgate can be opened from inside the vehicle.

Fold rear seats forward to access the tailgate ⇨ 45 and push up on emergency lever using a suitable screwdriver to open the tailgate.

Vehicle security**Anti-theft locking system****⚠ Warning**

Do not use the system if there are people in the vehicle! The doors cannot be unlocked from the inside.

The system deadlocks all the doors. All doors must be closed or the system cannot be activated.

Unlocking the vehicle disables the mechanical anti-theft locking system.

Activating**Anti-theft locking system with key**

Turn key in driver's door lock towards rear of vehicle twice within 3 seconds.

Anti-theft locking system with radio remote control

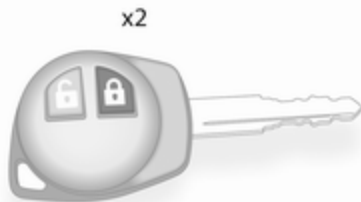



Press button  on the radio remote control twice within 3 seconds.

Immobiliser

The system is integrated into the ignition switch and checks whether the vehicle is allowed to start with the key being used. If the transponder in the key is recognised, the engine can be started.

The immobiliser is automatically activated when the key is turned to the **LOCK** position and removed from the ignition switch.





Control indicator  in the instrument cluster starts flashing after the key is turned to positions **LOCK** or **ACC**, or removed from the ignition switch.

If the control indicator  or  flashes when the ignition is on, there is a fault in the system; the engine cannot be started. Switch off the ignition and turn key to **LOCK** position and remove. Wait approx. 2 seconds and then repeat the start attempt.

If the control indicator continues flashing, attempt to start the engine using the spare key and seek the assistance of a workshop.

Note

The immobiliser does not lock the doors. Always lock the vehicle after leaving it  20.

Control indicators   62, 
 59.

Exterior mirrors

Convex shape

The convex exterior mirror reduces blind spots. The shape of the mirror makes objects appear smaller, which will affect the ability to estimate distances.

Manual adjustment



Adjust mirrors by swivelling lever in required direction.

Electric adjustment



Select the relevant exterior mirror by turning the control to left (L) or right (R). In the central position no mirror is selected.

Then swivel the control to adjust the mirror.

Return the control to the central position to prohibit further adjustment.

Folding



For pedestrian safety, the exterior mirrors will swing out of their normal mounting position if they are struck with sufficient force. Reposition the mirror by applying slight pressure to the mirror housing.

Heated

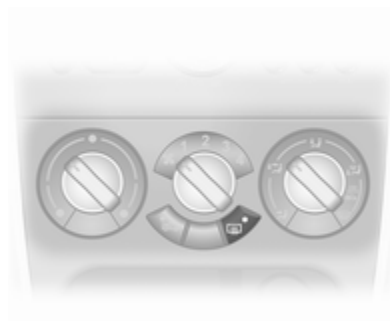

Operated by pressing the  button.

Heating works with the engine running and is switched off automatically after a short time.

Interior mirrors

Manual anti-dazzle



To reduce dazzle, adjust the lever on the underside of the mirror housing.

Windows

Manual windows

The door windows can be opened or closed with the window winders.

Power windows

⚠ Warning

Take care when operating the power windows. Risk of injury, particularly to children.

If there is a child on the front passenger seat, switch on the child safety system for the power windows.

Keep a close watch on the windows when closing them. Ensure that nothing becomes trapped in them as they move.

Power windows can be operated with key in ignition switch position **ON**.



Operate the switch for the respective window by pushing to open or pulling to close.

Pushing or pulling switch briefly: window moves up or down as long as switch is operated.

For automatic opening of the driver's door window, push the switch down fully and release it. Pull up the switch to stop the window movement.

In the event of difficulty due to frost or the like, pull the relevant window switch several times until the window is closed.

Child safety system



Press switch  to deactivate front passenger door power window operation when a child is occupying the seat.

To activate press  again.

Heated rear window

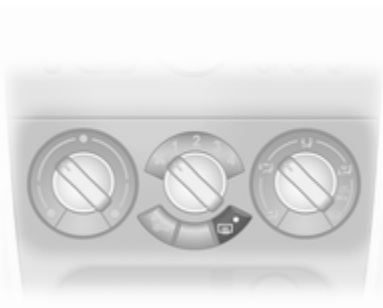

Operated by pressing the  button.

Heating works with the engine running and is switched off automatically after a short time.

Sun visors

The sun visors can be folded down or swivelled to the side to prevent dazzling.

If the sun visors have integral mirrors, the mirror covers should be closed when driving.

Seats, restraints

Head restraints	28
Front seats	29
Seat belts	31
Airbag system	33
Child restraints	38

Head restraints

Position

⚠ Warning

Only drive with the head restraint set to the proper position.

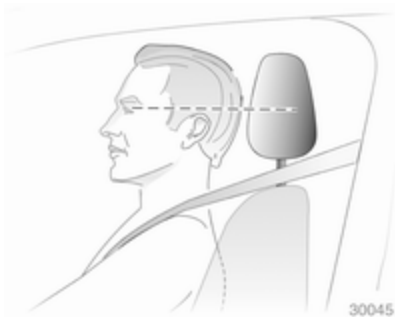

The middle of the head restraint should be at eye level. If this is not possible for extremely tall people, set to highest position, and set to lowest position for small people.

Adjustment

Head restraints on front seats



Height adjustment

Press the button, adjust height and engage.

Head restraints on rear seats

Height adjustment

Pull the head restraint upwards or push the head restraint downwards.

Front seats

Seat position

⚠ Warning

Only drive with the seat correctly adjusted.



- Sit with your buttocks as far back against the backrest as possible. Adjust the distance between the seat and the pedals so that your legs are slightly angled when

pressing the pedals. Slide the front passenger seat as far back as possible.

- Sit with your shoulders as far back against the backrest as possible. Set the backrest rake so that you can easily reach the steering wheel with your arms slightly bent. Maintain contact between your shoulders and the backrest when turning the steering wheel. Do not angle the backrest too far back. We recommend a maximum rake of approx. 25°.
- Adjust the steering wheel ↻ 50.
- Set seat height high enough to have a clear field of vision on all sides and of all display instruments. There should be at least one hand of clearance between your head and the roof frame. Your thighs should rest lightly on the seat without pressing into it.
- Adjust the head restraint ↻ 28.
- Adjust the height of the seat belt ↻ 32.

Seat adjustment

⚠ Warning

Never adjust seats while driving as they could move uncontrollably.

Seat positioning



Pull handle, slide seat, release handle.

⚠ Danger

Do not sit nearer than 25 cm (10 inches) from the steering wheel, to permit safe airbag deployment.

Seat backrests

Pull lever, adjust inclination and release lever. Allow the seat to engage audibly.

Do not lean on seat when adjusting.



Seat height

Operate lever in a pumping action

upwards = seat higher

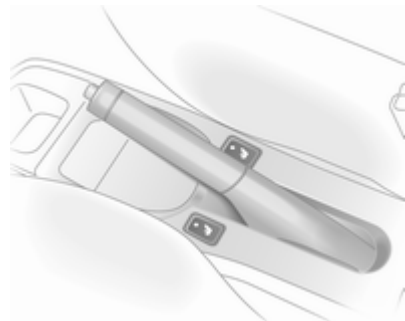
downwards = seat lower

Heating

Press the  button for the respective seat with the ignition on. The control indicator in the button illuminates. Press the  button again to switch off. The control indicator in the button extinguishes.

Seat belts



The belts are locked during heavy acceleration or deceleration of the vehicle for the safety of the occupants.

⚠ Warning

Fasten seat belt before each trip. In the event of an accident, people not wearing seat belts endanger their fellow occupants and themselves.

Seat belt reminder 58.

Seat belts are only designed for use by one person at a time. They are not suitable for people younger than 12 years of age or smaller than 150 cm (5 ft).

Periodically check all parts of the belt system for damage and proper functionality.

Have damaged components replaced. After an accident, have the belts and triggered belt tensioners replaced by a workshop.

Note

Make sure that the belts are not damaged by shoes or sharp-edged objects or trapped. Prevent dirt from getting into the belt retractors.

Belt force limiters

In the front seats, stress on the body is reduced by the gradual release of the belt during a collision.

Belt tensioners

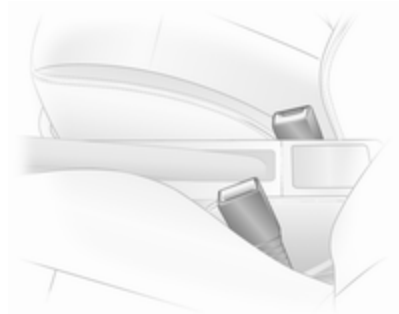

In the event of a head-on or rear-end collision of a certain severity, the front seat belts are tightened.

⚠ Warning

Incorrect handling (e.g. removal or fitting of belts) can trigger the belt tensioners.

Deployment of the belt tensioners is indicated by continuous illumination of control indicator 58.

Triggered belt tensioners must be replaced by a workshop. Belt tensioners can only be triggered once.

Note

Do not affix or install accessories or other objects that may interfere with the operation of the belt tensioners. Do not make any modifications to belt tensioner components as this will invalidate the vehicle type approval.

Three-point seat belt

Fitting



Withdraw belt from retractor, guide it untwisted across the body and insert the latch plate in the buckle. Tension the lap belt regularly whilst driving by tugging the shoulder belt.



Loose or bulky clothing prevents the belt from fitting snugly. Do not place objects such as handbags or mobile phones between the belt and your body.

Warning

The belt must not rest against hard or fragile objects in the pockets of your clothing.

Height adjustment

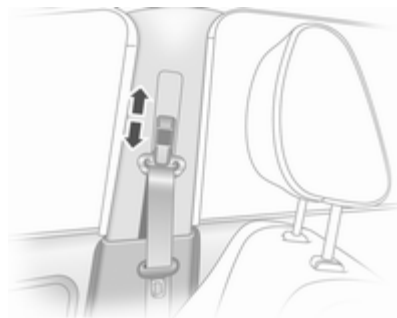

1. Pull belt out slightly.
2. Pull out lock knob.
3. Adjust height and engage.

Adjust the height so that the belt lies across the shoulder. It must not lie across the throat or upper arm.

Do not adjust while driving.

Removing



30054

To release belt, press red button on belt buckle.

Seat belts on the rear seats

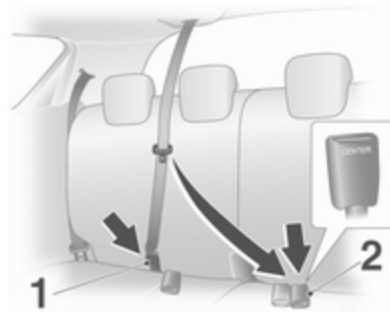

The seat belt for the middle seat has a twin buckle arrangement. Engage the smaller latch plate (1) into the correct buckle, then pull the seat belt across and audibly engage the buckle marked **CENTER** (2).

Using the seat belt while pregnant

⚠ Warning

The lap belt must be positioned as low as possible across the pelvis to prevent pressure on the abdomen.

Airbag system

The airbag system consists of a number of individual systems.

When triggered the airbags inflate within milliseconds. They also deflate so quickly that it is often unnoticeable during the collision.

⚠ Warning

If handled improperly the airbag systems can be triggered in an explosive manner.

Note

The airbag systems and belt tensioner control electronics are located in the centre console area. Do not put any magnetic objects in this area.

Do not stick anything on the airbag covers and do not cover them with other materials.

Each airbag is triggered only once. Have deployed airbags replaced by a workshop.

Do not make any modifications to the airbag system as this will invalidate the vehicle type approval.

In the event of airbag deployment have the steering wheel, the instrument panel, all panelling parts, the door seals, the handles and the seats removed by a workshop.

Control indicator  for airbag systems
 ⇨ 58.

Front airbag system

The front airbag system consists of one airbag in the steering wheel and one in the instrument panel on the

front passenger side. These can be identified by the words **SRS AIRBAG**.



30036

There is also a warning label on the side of the instrument panel, visible when the front passenger door is open.

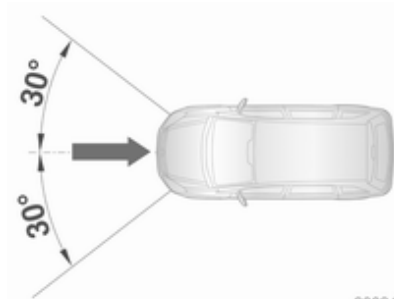

30034

The front airbag system is triggered in the event of an accident of a certain severity in the depicted area. The ignition must be on.

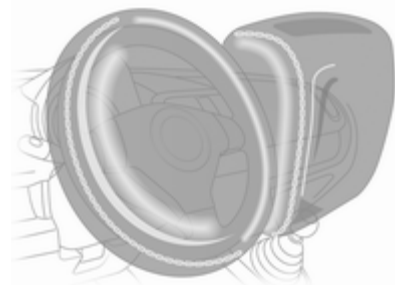

The forward movement of the front seat occupants is decelerated, thereby considerably reducing the risk of injury to the upper body and head.

⚠ Warning

Optimum protection is only provided when the seat is in the proper position ↗ 29.

Keep the area in which the airbag inflates clear of obstructions.

Fit the seat belt correctly and engage securely. Only then the airbag is able to protect.

Side airbag system



The side airbag system consists of an airbag in each front seat backrest and in the rear outboard seat backrests. This can be identified by the words **SRS AIRBAG**.

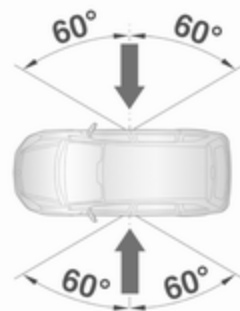

30035

The side airbag system is triggered in the event of an accident of a certain severity in the depicted area. The ignition must be on.

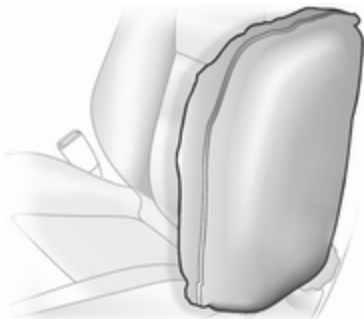

The risk of injury to the upper body and pelvis in the event of a side-on collision is considerably reduced.

⚠ Warning

Keep the area in which the airbag inflates clear of obstructions.

Note

Only use protective seat covers that have been approved for the vehicle. Be careful not to cover the airbags.

Curtain airbag system

The curtain airbag system consists of an airbag in the roof frame on each side. This can be identified by the word **SRS AIRBAG** on the roof pillars.

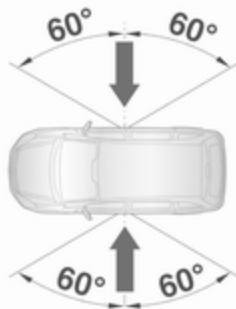

30035

The curtain airbag system is triggered in the event of an accident of a certain severity in the depicted area. The ignition must be on.

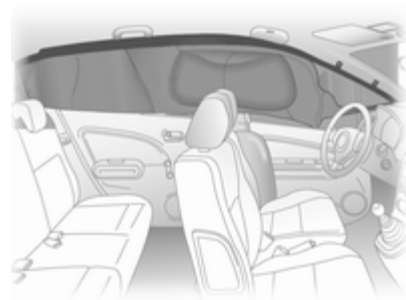

The risk of injury to the head in the event of a side impact is considerably reduced.

⚠ Warning

Keep the area in which the airbag inflates clear of obstructions.

The hooks on the handles in the roof frame are only suitable for hanging up light articles of clothing, without coat hangers. Do not keep any items in these clothes.





Airbag deactivation

Front airbag and side airbag systems for the front passenger seat have to be deactivated if a child restraint system is to be fitted on this seat. The curtain airbag system, the belt tensioners and all driver airbag systems will remain active.



Front passenger airbag system can be deactivated via a lock on the side of the instrument panel, visible when the front passenger door is open.

Use the ignition key to choose the position:

-  = front passenger airbags are deactivated and will not inflate in the event of a collision. Control indicator  illuminates continuously. A child restraint system can be installed in accordance with the chart  39.
-  = front passenger airbags are active. No child restraint systems can be installed.



As long as the control indicator  is not illuminated, the airbag systems for the front passenger seat will inflate in the event of a collision.

Change status only when the vehicle is stopped with the ignition off.

Status remains until the next change.

Control indicator for airbag deactivation  58.

Child restraints

Child restraint systems

When a child restraint system is being used, pay attention to the following usage and installation instructions and also those supplied with the child restraint system.

Always comply with local or national regulations. In some countries, the use of child restraint systems is forbidden on certain seats.

Warning

When using a child restraint system on the front passenger seat, the airbag systems for the front passenger seat must be deactivated; if not, the triggering of the airbags poses a risk of fatal injury to the child.

This is especially the case if rear-facing child restraint systems are used on the front passenger seat.

Selecting the right system

Children should travel in a rear-facing child restraint until as old as possible. It is appropriate to change the system when the child's head can no longer be properly supported at eye height. The child's cervical vertebrae are still very weak and in an accident they suffer less stress in the semi-prone rearward position than when sitting upright.

Children under 12 years or under 150 cm (5 ft) tall should only travel in an appropriate child restraint system.

Never carry a child while travelling in the vehicle. The child will become too heavy to hold in the event of a collision.

When transporting children, use the child restraint systems suitable for the child's weight.

Ensure that the child restraint system to be installed is compatible with the vehicle type.

Ensure that the mounting location of the child restraint system within the vehicle is correct.

Only allow children to enter and exit the vehicle at the side facing away from the traffic.

When the child restraint system is not in use, secure the seat with a seat belt or remove it from the vehicle.

Note

Do not stick anything on the child restraint systems and do not cover them with any other materials.

A child restraint system which has been subjected to stress in an accident must be replaced.

Child restraint installation locations

Permissible options for fitting a child restraint system

Weight and age class	On front passenger seat		On rear outboard seats	On rear centre seat
	active airbag	deactivated airbag		
Group 0: up to 10 kg or approx. 10 months	X	U ¹	U ²	X
Group 0+: up to 13 kg or approx. 2 years	X	U ¹	U ²	X
Group I: 9 to 18 kg or approx. 8 months to 4 years	X	U ¹	U ²	X
Group II: 15 to 25 kg or approx. 3 to 7 years	X	X	U	X
Group III: 22 to 36 kg or approx. 6 to 12 years	X	X	U	X

¹ = Only if front passenger seat airbag systems are deactivated. Adjust seat height to uppermost position. For Group 0 and 0+; front passenger seat must be in its rearmost position. For Group I; ensure that vehicle seat belt runs forwards from the upper anchorage point.

² = Seat available with ISOFIX and Top-Tether mounting brackets.

U = Universal suitability in conjunction with three-point seat belt.

X = No child restraint system permitted in this weight class.

Permissible options for fitting an ISOFIX child restraint system

Weight class	Size class	Fixture	On front passenger seat	On rear outboard seats	On rear centre seat
Group 0: up to 10 kg	E	ISO/R1	X	IL	X
Group 0+: up to 13 kg	E	ISO/R1	X	IL	X
	D	ISO/R2	X	IL	X
	C	ISO/R3	X	IL	X
Group I: 9 to 18 kg	D	ISO/R2	X	IL	X
	C	ISO/R3	X	IL	X
	B	ISO/F2	X	IL, IUF ¹	X
	B1	ISO/F2X	X	IL, IUF ²	X
	A	ISO/F3	X	IL, IUF ¹	X

¹ = Head restraint must be in its uppermost locking position or removed and stowed securely in the load compartment.

² = Head restraint must be removed and stowed securely in the load compartment.

IL = Suitable for particular ISOFIX restraint systems of the 'specific-vehicle', 'restricted' or 'semi-universal' categories. The ISOFIX child restraint system must be approved for the specific vehicle type.

IUF = Suitable for ISOFIX forward-facing child restraint systems of universal category approved for use in this mass group.

X = No ISOFIX child restraint system approved in this weight class.

ISOFIX size class and seat device

- A – ISO/F3 = Forward-facing child restraint system for children of maximum size in the weight class 9 to 18 kg.
- B – ISO/F2 = Forward-facing child restraint system for smaller children in the weight class 9 to 18 kg.
- B1 – ISO/F2X = Forward-facing child restraint system for smaller children in the weight class 9 to 18 kg.
- C – ISO/R3 = Rear-facing child restraint system for children of maximum size in the weight class up to 13 kg.
- D – ISO/R2 = Rear-facing child restraint system for smaller children in the weight class up to 13 kg.
- E – ISO/R1 = Rear-facing child restraint system for young children in the weight class up to 13 kg.

Isfix child restraint systems



Fasten vehicle-approved ISOFIX child restraint systems to the mounting brackets.

When using ISOFIX mounting brackets for seat mounting, universally approved child restraint systems for ISOFIX may be used.

Top-tether child restraint systems

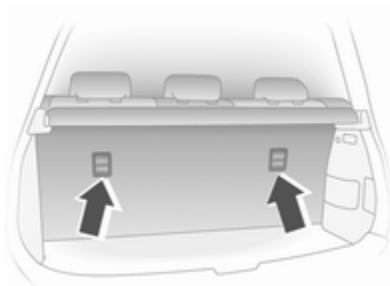

Fasten Top-Tether child restraint systems to the fastening eyes behind the rear head restraints. The strap must run between the two guide rods of the head restraint.

When using Top-Tether for seat mounting, universally approved child restraint systems for Top-Tether may be used.

Storage

Storage compartments	43
Load compartment	45
Roof rack system	48
Loading information	48

Storage compartments

Instrument panel storage

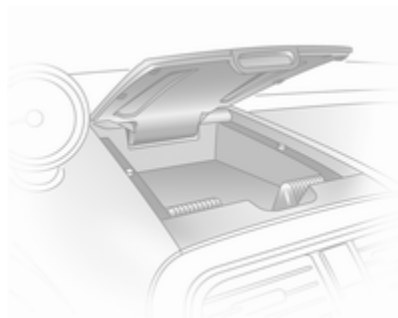

To open the instrument panel upper tray, lift front edge of lid.
To close, push lid down until it latches into position.

Caution

Do not leave glasses, CDs, CD cases or flammable items, e.g. cigarette lighter, in the tray when parked in direct sunlight or in hot weather, as the tray may become very hot.



An additional storage compartment is located above the glovebox.

Glovebox

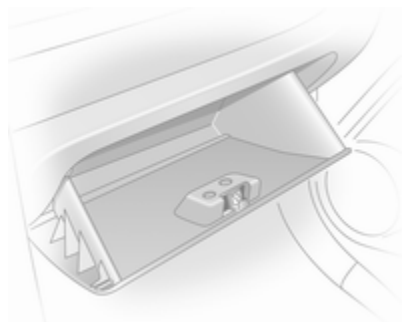

The glovebox should be closed while driving.

Cupholders

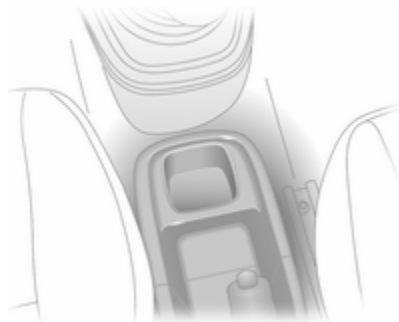

A cupholder is located in the front of the centre console.

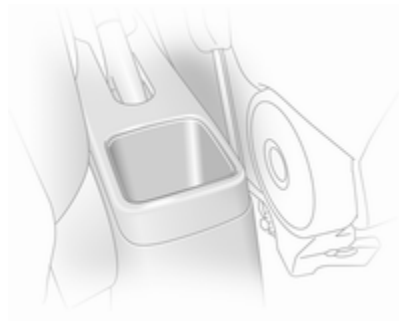

An additional cupholder is located at the back of the console.

Sunglasses storage

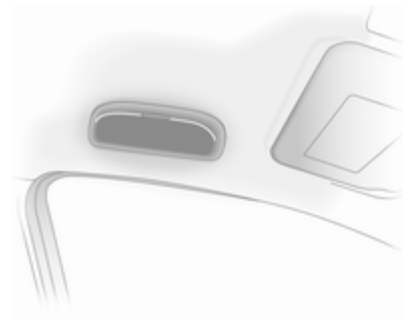

Fold down to open.

Do not use for storing heavy objects.

Load compartment

Folding down rear backrests

Remove load compartment cover as necessary.

Push head restraints down by pressing the catch.

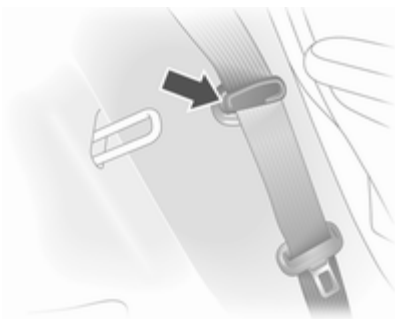

Put the seat belts of the outer seats into belt guides.

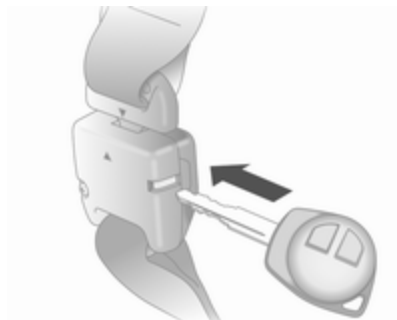

Release the centre seat belt detachable connector by inserting the ignition key into the slot. Allow the seat belt to fully retract.

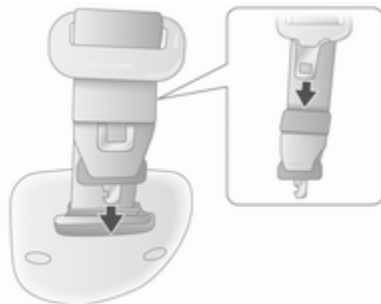

Insert the latch plate into the slit on the seat belt and insert the detached connector latch plate into the roof holder slot.



Pull release lever on one or both sides and fold down the backrests onto the seat cushion.



On the one piece backrest, pull both release levers and fold down the backrest onto the seat cushion.

To fold up, raise backrests and guide them into upright position until they engage audibly.



Pull the centre seat belt connector latch plate from the roof holder slot. Insert it into the connector, with the arrows aligned, until it audibly engages.

Load compartment cover

Do not place any objects on the cover.

Removing

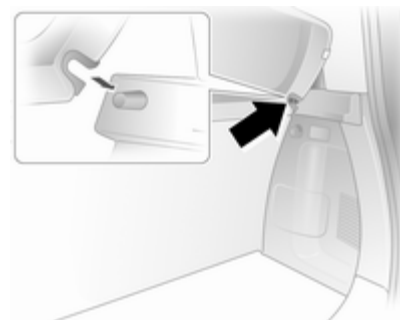

Pull cover from the side guides.

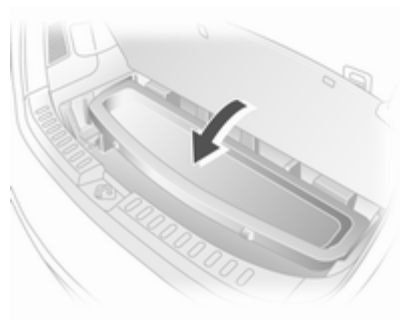

The cover can be stored in the rear floor storage compartment.

Fitting

Engage cover in side guides.

Rear floor storage cover



To access the rear floor storage compartment, lift the floor carpet using the central strap located near the tailgate latch and hang the string on the hook provided.

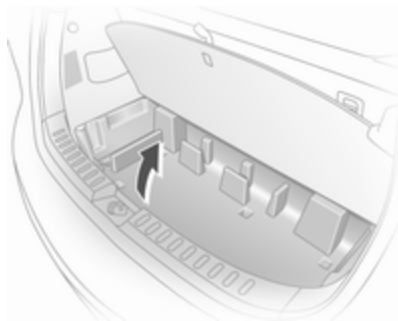

The rear floor storage compartment is removable. To remove, pull up using the handle located near the tailgate latch.

To install, fit compartment into brackets behind outboard rear seatbacks, then push down into clips on both sides of load compartment.

Warning triangle

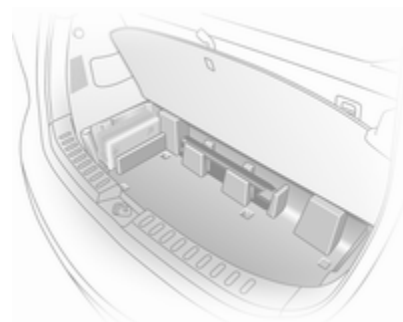

Stow the warning triangle in the rear floor storage compartment in the space behind the rear seat.

First aid kit

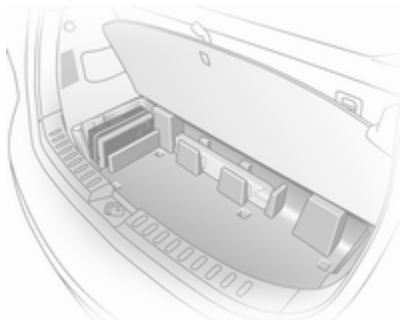

Stow the first aid kit in the space on the left hand side of the rear floor storage compartment.

Roof rack system

Roof rack

For safety reasons and to avoid damage to the roof, the vehicle approved roof rack system is recommended.

Follow the installation instructions and remove the roof rack when not in use.

Loading information



- Heavy objects in the load compartment should be placed against the seat backrests. Ensure the backrests are securely engaged. If objects can be stacked, the heavier objects should be placed at the bottom.
- Secure objects with lashing straps attached to lashing eyes.
- Secure loose objects in load compartment to prevent sliding.

- When transporting objects in the load compartment, the backrests of the rear seats must not be angled forward.
- Do not allow the load to protrude above the upper edge of the backrests.
- Do not place any objects on the load compartment cover or the instrument panel, and do not cover the sensor on top of the instrument panel.
- The load must not obstruct the operation of the pedals, parking brake and gear selector, or hinder the freedom of movement of the driver. Do not place any unsecured objects in the interior.
- Do not drive with an open load compartment.
- The payload is the difference between the permitted gross vehicle weight (see identification plate ⇨ 130) and the EC kerb weight.

To calculate the EC kerb weight, enter the data for your vehicle in the Weights table, ⇨ 3.

The EC kerb weight includes weights for the driver (68 kg), luggage (7 kg) and all fluids (tank 90% full).

Optional equipment and accessories increase the kerb weight.

- Driving with a roof load increases the sensitivity of the vehicle to cross-winds and has a detrimental effect on vehicle handling due to the vehicle's higher centre of gravity. Distribute the load evenly and secure it properly with retaining straps. Adjust the tyre pressure and vehicle speed according to the load conditions. Check and retighten the straps frequently.

The permissible roof load is 35 kg. The roof load is the combined weight of the roof rack and the load.

Instruments and controls

Controls	50
Warning lights, gauges and indicators	54
Vehicle messages	63
Trip computer	63

Controls

Steering wheel adjustment

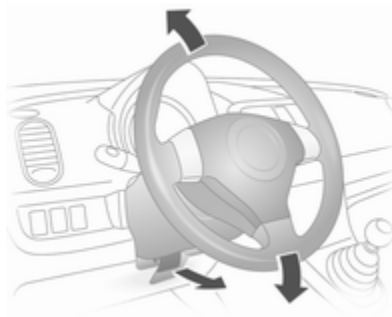

Unlock lever, adjust steering wheel, then engage lever and ensure it is fully locked.

Do not adjust steering wheel unless vehicle is stationary and steering wheel lock has been released.

Steering wheel controls



The infotainment system can be operated via the controls on the steering wheel.

Infotainment system ⇨ 70.

Horn



Press .

Windscreen wiper/washer

Windscreen wiper

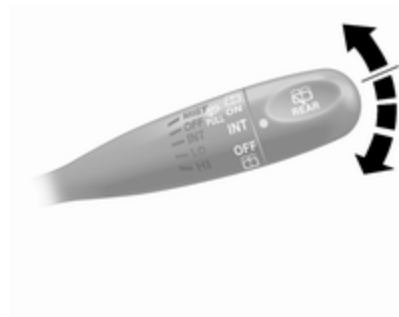

- MIST** = misting function
OFF = off
INT = adjustable timed interval wiper
LO = slow
HI = fast

For a single swipe, move lever up from position **OFF**.

Do not use if the windscreen is frozen.

Switch off in car washes.

Adjustable wiper interval

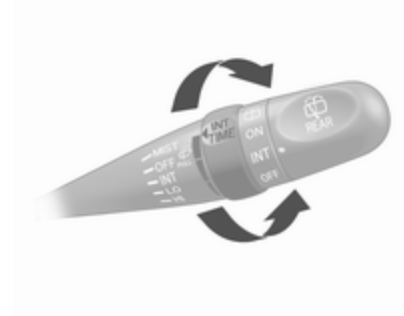

Set the lever to position **INT**.

Turn the adjuster wheel to adjust the wiping interval:

- | | |
|----------------|---------------------------------|
| short interval | = turn adjuster wheel upwards |
| long interval | = turn adjuster wheel downwards |

Windscreen washer

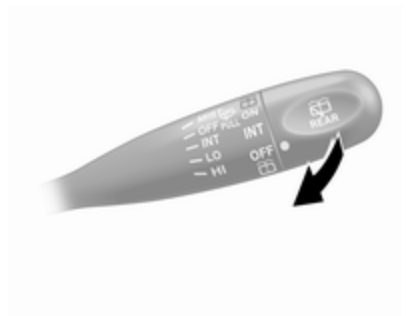



Pull lever. Washer fluid is sprayed onto the windscreen.

In vehicles with timed interval wipe position **INT**, the wipers switch on automatically at low speed if they are not already activated.

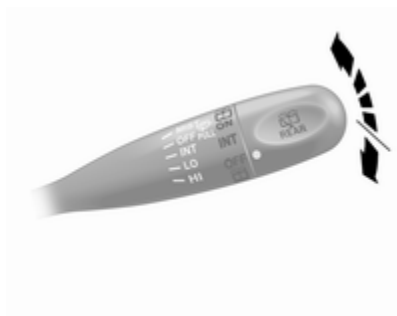
Rear window wiper/washer



Turn:

-  = washer fluid is sprayed onto the rear window
- OFF** = off
- INT** = intermittent operation
- ON** = continuous operation
-  = washer fluid is sprayed onto the rear window

Outside temperature



The outside temperature is shown in the odometer display when the ignition is switched on.

If outside temperature drops to near freezing point (0 °C), the symbol ❄ illuminates in the odometer display as a warning for icy road conditions.

Warning

The road surface may already be icy even though the display indicates a few degrees above 0 °C.

Clock

The time is shown in the odometer display when the ignition is switched on.

Setting the time

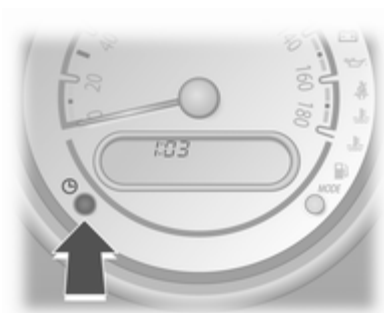

Press and hold the \oplus button for approx. 2 seconds; clock display now in setting mode.

Minute display flashes.

Press \oplus to set minutes.

Release \oplus for approx. 5 seconds to set minute display.

Hour display flashes.

Press \oplus to set hours.

Release \oplus for approx. 5 seconds to set hour display.

Power outlets



A 12 V power outlet is located in the centre console and is operational with ignition switch in positions **ACC** or **ON**.

Do not exceed the maximum power consumption of 120 watts.

Electrical accessories that are connected must comply with the electromagnetic compatibility requirements laid down in DIN VDE 40 839.

Do not connect any current-delivering accessories, e.g. electrical charging devices or batteries.

Do not damage the outlets by using unsuitable plugs.

Cigarette lighter

Operational with ignition switch in positions **ACC** or **ON**.

Press in cigarette lighter. Switches off automatically once the element is glowing. Pull out lighter.

Ashtrays

Caution
To be used only for ash and not for combustible rubbish.

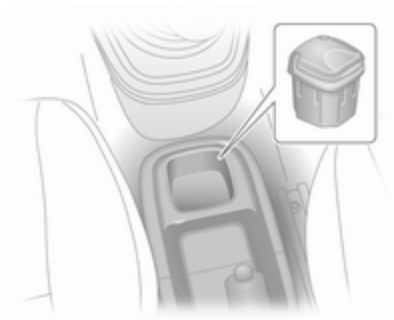

The portable ashtray can be fitted in the front or rear cup holder in the centre console.

Warning lights, gauges and indicators

Speedometer



Indicates vehicle speed.

Odometer

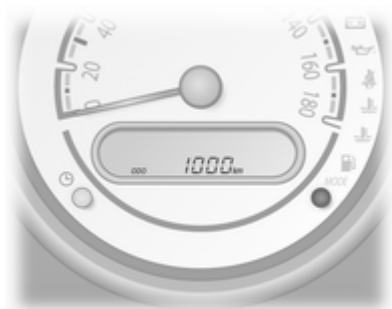

Displays the recorded distance.

Odometer display brightness



To change brightness level, switch on headlights and press the **MODE** button repeatedly until the squares that indicate the brightness level appear in the odometer display.

□□□□ = maximum brightness
 □ = minimum brightness

Press and hold the **MODE** button to cycle through brightness levels.

Trip odometer

Displays the recorded distance since the last reset.

There are two independent trip odometers which indicate how far the vehicle has been driven since the last reset.

Press the **MODE** button repeatedly until **A** or **B** appears on the left of the display.

To reset a trip odometer, press and hold the **MODE** button for approx. 2 seconds while the relevant trip odometer is displayed.

Tachometer



Displays the engine speed.

Drive in a low engine speed range for each gear as much as possible.

Caution

If the needle is in the red warning zone, the maximum permitted engine speed is exceeded. Engine at risk.

Fuel gauge

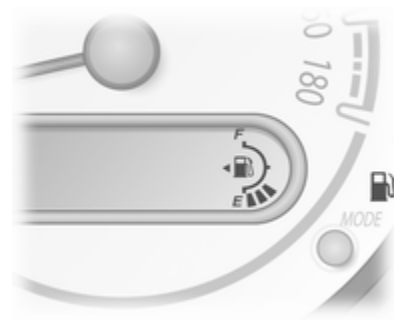

Displays the fuel level in the tank (**F** indicates full, **E** indicates empty).

Control indicator  illuminates if the level in the tank is low. Refuel immediately.

Never run the tank dry.

Because of the fuel remaining in the tank, the top-up quantity may be less than the specified tank capacity.

Service display

In the case of vehicles with fixed engine oil change and service intervals, **InSP** appears in the odometer display if the ignition is switched on when servicing is overdue: have the next service carried out within one week or 500 km (300 miles). Seek the assistance of a workshop.

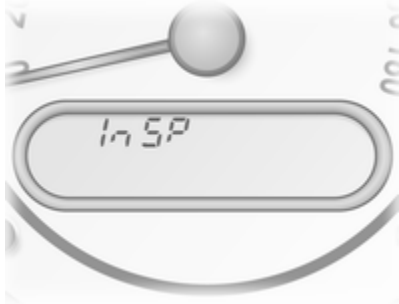

After the service is complete, have the display reset. Seek the assistance of a workshop.

Transmission display

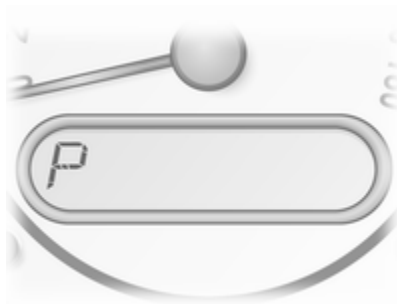

The mode or selected gear is shown in the transmission display.

- P** = Automatic transmission park position
- R** = Reverse gear
- N** = Neutral
- D** = Drive
- L, 2, 3** = Selected gear, automatic transmission

Control indicators

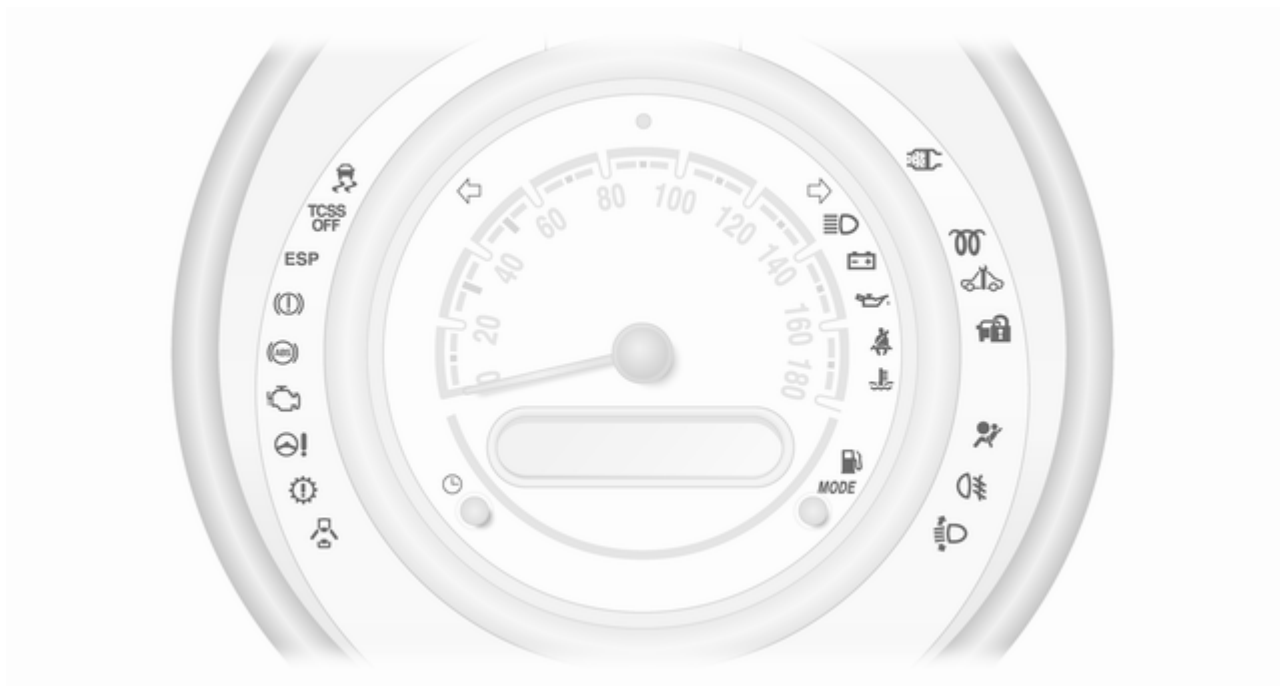

The control indicators described are not present in all vehicles. The description applies to all instrument versions. When the ignition is switched on, most control indicators will illuminate briefly as a functionality test.

The control indicator colours mean:

- red = danger, important reminder
- yellow = warning, information, fault
- green = confirmation of activation
- blue = confirmation of activation

Turn signal

↔ flashes green.

Flashes if a turn signal or the hazard warning flashers are activated.

Rapid flashing: failure of a turn signal light or associated fuse.

Bulb replacement ⇨ 100.

Fuses ⇨ 104.

Turn signals ⇨ 67.

Seat belt reminder

🚗 for driver seat illuminates or flashes red.

Illuminates

After the ignition is switched on until the seat belt is fastened.

Flashes

If vehicle speed exceeds 15 km/h (9 mph) and driver seat belt is not fastened, 🚗 will flash for approx. 90 seconds along with a warning chime.

🚗 will then illuminate until driver seat belt is fastened.

Fastening the seat belt ⇨ 32.

Airbag and belt tensioners

🚗 illuminates red.

When the ignition is switched on, 🚗 flashes several times. If it does not flash when the ignition is switched on, stays lit, illuminates or flashes while driving, there is a fault in the belt tensioner or the airbag system. The airbags and belt tensioners may fail to trigger in the event of an accident.

Deployment of the belt tensioners or airbags is indicated by continuous illumination of 🚗.

⚠ Warning

Have the cause of the fault remedied immediately by a workshop.

Belt tensioners, airbag system ⇨ 31, ⇨ 33.

Airbag deactivation

🚗₂ for front passenger airbag illuminates or flashes yellow.

Illuminates

When the front and side airbag systems for the front passenger seat have been deactivated.

Flashes

When the ignition is switched on.

Airbag system ⇨ 33, belt tensioners ⇨ 31.

Charging system

 illuminates red.

Illuminates when the ignition is switched on and goes out shortly after the engine starts.

Illuminates when the engine is running

Stop, switch off engine. Battery is not charging. Engine cooling may be interrupted. Power to the brake servo unit may be cut. Seek the assistance of a workshop.

Malfunction indicator light

 illuminates yellow.

Illuminates when the ignition is switched on and goes out shortly after the engine starts.

Illuminates when the engine is running

Fault in the emission control system. The permitted emission limits may be exceeded. Seek the assistance of a workshop immediately.

Diesel engines

The engine stops and  illuminates if the fuel level is too low. If the tank has been run dry, bleed the fuel system ⇨ 99.

Vehicles with electric throttle body system

If the battery has been disconnected, the system must be recalibrated upon reconnection of the battery. Hold ignition key in **ON** position for 5 seconds without running the engine.

If the procedure is not successful  remains illuminated after the engine is started. Seek the assistance of a workshop immediately.

Service vehicle soon

Diesel engines

 illuminates or flashes in yellow.

Illuminates when the engine is running

Fault in the engine electronics. Seek the assistance of a workshop immediately.

Illuminates in combination with  if cleaning of the diesel particle filter is not successful or possible. Seek the assistance of a workshop immediately. Diesel particle filter ⇨ 84.

Flashes

When the ignition is switched on, there may be a fault in the immobiliser system; the engine cannot be started. Immobiliser ⇨ 24.

Brake system

 illuminates red.

Illuminates when the parking brake is released if the brake fluid level is too low ⇨ 98.

Warning

Stop. Do not continue your journey. Consult a workshop.



Illuminates after the ignition is switched on if the parking brake is applied ⇨ 89.

Antilock brake system (ABS)

 illuminates yellow.

Illuminates briefly after the ignition is switched on. The system is ready for operation when the  goes out.

If  does not go out after a few seconds, or if it illuminates while driving, there is a fault in the ABS. The brake system remains operational but without ABS regulation.

If during driving  illuminates in conjunction with , there is a serious fault in the brake system. Seek the assistance of a workshop immediately.

Antilock brake system ⇨ 88.

Transmission

 illuminates or flashes yellow.

If it flashes when the engine is running there is a fault in the automatic transmission. Seek the assistance of a workshop immediately.

Automatic transmission ⇨ 86.

Power steering

 illuminates yellow.

If  does not illuminate when the ignition is switched on, stays lit or illuminates during driving, there is a fault in the power steering system. The vehicle can be steered but considerably more force is required. Contact a workshop.

Electronic Stability Program

 illuminates or flashes yellow.

Illuminates

There is a fault in the system. Continued driving is possible. Driving stability, however, may deteriorate depending on road surface conditions.

Have the cause of the fault remedied by a workshop.

Flashes

The system is actively engaged. Engine output may be reduced and the vehicle may be braked automatically to a small degree.

If the vehicle's battery has been disconnected and reconnected, the system is deactivated and  flashes once per second. Reactivate system by driving in a straight line at over 15 km/h (9 mph) briefly until flashing ceases.

Electronic Stability Program fault

ESP illuminates yellow.

If it illuminates during driving, there is a fault with ESP®. The vehicle's brake system remains operational without ESP® regulation. Seek the assistance of a workshop.

Electronic Stability Program ⇨ 90.

Traction Control system off

TCSS OFF illuminates yellow.

Illuminates continuously when the system is deactivated.

Traction control system TCSS ⇨ 90.

Engine coolant temperature

 illuminates or flashes red.

Illuminates or flashes when the engine is running if the coolant temperature is too high.

Caution

If engine coolant temperature is too high, stop vehicle, switch off engine. Danger to engine. Check coolant level.

Coolant level ⇨ 97.

If there is sufficient coolant, consult a workshop.

Preheating

 illuminates yellow.

Illuminates when preheating is activated. Only activates when outside temperature is low.

Diesel particle filter

 illuminates yellow.

If it illuminates when the engine is running diesel particle filter requires cleaning.

As soon as the road and traffic situation permits it, increase speed to more than 75 km/h (50 mph) for approx. 30 minutes.

 extinguishes as soon as cleaning is complete.

Diesel particle filter ⇨ 84.

Engine oil pressure

 illuminates red.

Illuminates when the ignition is switched on and goes out shortly after the engine starts.

Illuminates when the engine is running

Caution

Engine lubrication may be interrupted. This may result in damage to the engine and/or locking of the drive wheels.

1. Move out of the flow of traffic as quickly as possible without impeding other vehicles.
2. Depress clutch.
3. Select neutral gear, set selector lever to N.
4. Switch off ignition.

Warning

When the engine is off, considerably more force is needed to brake and steer.

Do not remove key until vehicle is stationary, otherwise the steering wheel lock could engage unexpectedly.

Check oil level before seeking assistance of a workshop ⇨ 96.

Change engine oil

Diesel engines with diesel particle filter

 flashes red.



When the system has calculated that oil life has been diminished,  flashes in the instrument cluster when the engine is running. Have engine oil and filter changed by a workshop within one week or 500 km (300 miles) (whichever occurs first).

Engine power may be decreased. For the system to work properly, it must be reset every time the engine oil and oil filter are changed: seek the assistance of a workshop.



Low fuel

 illuminates yellow.

Illuminates when level in fuel tank is too low.

Catalytic converter  85.

Diesel engines



The engine stops and  illuminates if the fuel level is too low  59.

Bleeding the diesel fuel system  99.

Immobiliser

 illuminates or flashes yellow.

Illuminates

 (or  for diesel engines) illuminates when the ignition is switched on and goes out shortly after the engine starts.

Flashes

After the ignition is switched on, there may be a fault in the immobiliser system. The engine cannot be started.

High beam

 illuminates blue.

Illuminated when high beam is on and during headlight flash  65.

Headlight levelling system

 illuminates during driving to indicate a fault that requires immediate attention. Seek the assistance of a workshop as soon as possible.

Headlight range adjustment  66.

Fog light

 illuminates green.

Illuminated when the front fog lights are on  67.

Rear fog light

 illuminates yellow.

Illuminated when the rear fog light is on  67.

Door open

 illuminates red.

Illuminates when a door or the tailgate is open.

Vehicle messages

Warning chimes

When starting the engine or while driving

- If the driver's seat belt is not fastened and vehicle speed exceeds approx. 15 km/h (9 mph).
- When operating the turn signals.

When the vehicle is parked and/or the driver's door is opened

- When the key is in the ignition switch.
- With exterior lights on (and ignition key removed).

Seat belt reminder ⇨ 58.

Trip computer

The functions can be selected by pressing the **MODE** button repeatedly in the instrument cluster.

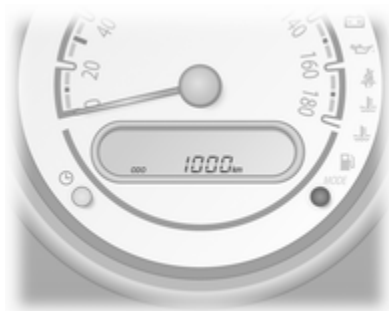

Press the **MODE** button to select one of the functions:

- Range
- Average consumption
- Instantaneous consumption

Range

Range is calculated from current fuel tank content and current consumption. The display shows average values.

After refuelling, the range is updated automatically after a brief delay.

When the fuel level in the tank is low, --.- appears in the odometer display.

Additionally the control indicator  in the instrument cluster illuminates.

Average consumption

Display of average consumption. The measurement can be reset at any time.

To reset, press the **MODE** button for a few seconds while the average consumption is showing in the display.

The display will show --.- briefly and the average consumption figure will update after a brief delay.

Instantaneous consumption

Display of the instantaneous consumption. Until the vehicle is moving, --.- appears in the display.

Setting units of measure

You can select which units of measure are to be used for fuel consumption figures.

With the vehicle stationary and with instantaneous consumption showing in the display, press and hold the **MODE** button for a few seconds to toggle between L/100km and km/L.

Interruption of power supply

If the power supply has been interrupted or if the battery voltage has dropped too low, the values stored in the trip computer will be lost.

Lighting



Exterior lighting	65
Interior lighting	68

Exterior lighting

Light switch



Turn light switch:

-  = Headlights
-  = Sidelights
- OFF = Off

High beam

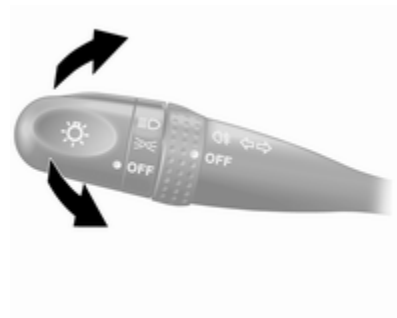

To switch from low to high beam, push lever.

To switch to low beam, push lever again or pull.

Headlight flash

To activate the headlight flash, pull lever.

Headlight range adjustment

Manual headlight range adjustment



To adapt headlight range to the vehicle load to prevent dazzling: turn knurled wheel to required position.

- 0 = front seats occupied
- 1 = all seats occupied
- 2 = all seats occupied and load compartment laden¹⁾
- 2 = driver's seat occupied and load compartment laden

Headlights when driving abroad

The asymmetrical headlight beam extends visibility at the edge of the road at the passenger side.

However, when driving in countries where traffic drives on the opposite side of the road, adjust the headlights to prevent dazzling.

Have the headlights adjusted by a workshop.

Daytime running lights

Daytime running lights increase visibility of the vehicle during daylight.

When the engine is started, this system turns on all lights. This is cancelled when the light control lever is turned to any position other than **OFF**.

The daytime running lights switch off when the ignition is switched off.

Hazard warning flashers



Operated with the  button.

¹⁾ Vehicles with automatic transmission and all diesel engines: set to position 1.

Turn and lane-change signals



lever up = right indicator
 lever down = left indicator

If the lever is moved past the resistance point, the indicator is switched on constantly. When the steering wheel moves back, the indicator is automatically deactivated. For three flashes, e.g. when changing lanes, press the lever until resistance is felt and then release.

Move the lever to the resistance point and hold for longer indication.

Switch the indicator off manually by moving the lever to its original position.

Front fog lights



Operated with the D button.

Front fog lights will only operate when the headlights or sidelights are switched on.

Rear fog lights



Turn inner switch to D .

Rear fog light will only operate when the headlights are switched on.

Reversing lights

The reversing lights come on when the ignition is on and reverse gear is selected.

Interior lighting

Interior lights

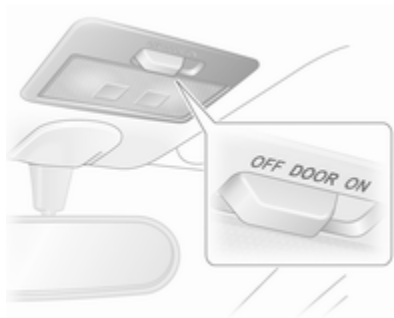

During entry and exit of the vehicle, the light automatically switches on and then off after a delay.

Operate switch:

- OFF** = always off
- DOOR** = automatic switching on and off
- ON** = always on

Caution

To prevent the battery from becoming discharged, do not leave the interior light switch in the ON position when leaving the vehicle.

Load compartment lighting

The lighting switches on when opened.

Infotainment system

Introduction	70
Radio	73
Audio players	75
Phone	76

Introduction

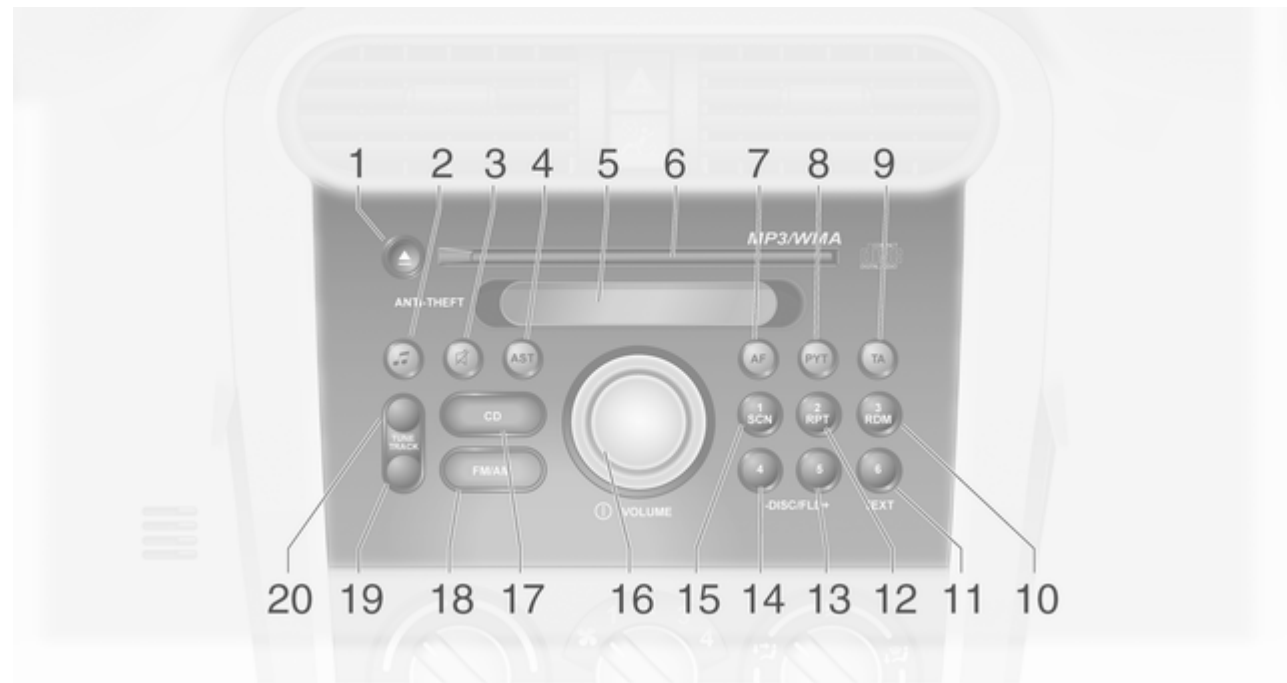

1. **▲**: CD eject
2. **⌂**: Sound settings
3. **⌘**: Mute/unmute
4. **AST**: Auto search
5. Display
6. CD slot
7. **AF**: Alternative Frequency
8. **PTY**: Program Type
9. **TA**: Traffic Announcement
10. **3, RDM**: Radio preset station 3, CD/MP3 random playback
11. **6, TEXT**: Radio preset station 6, MP3 text display
12. **2, RPT**: Radio preset station 2, CD/MP3 repeat track
13. **5, DISC/FLD+**: Radio preset station 5, MP3 skip to next folder
14. **4, -DISC/FLD**: Radio preset station 4, MP3 skip to previous folder
15. **1, SCN**: Radio preset station 1, CD scan tracks
16. **Ⓞ VOLUME**: Press for on and off, Turn for volume
17. **CD**: CD player mode
18. **FM/AM**: Switch between FM and AM wavebands
19. **∇**: Radio search downwards, CD/MP3 skip backwards
20. **∧**: Radio search upwards, CD/MP3 skip forwards

Steering wheel mounted controls

+ or -: volume

⌘: Mute/unmute

MODE: Change modes and switches system on

∇: Radio search downwards, CD/MP3 skip backwards

∧: Radio search upwards, CD/MP3 skip forwards

Theft-deterrent feature

The electronic security code makes the unit inoperable if it is removed or if the vehicle battery is disconnected unless the correct 4-digit code is entered. The default code is 0000 when delivered new.

Setting a new 4-digit security ID

1. Press the **Ⓞ VOLUME** control to switch off.
2. Press and hold the buttons numbered 3 and 4 simultaneously and press the **Ⓞ VOLUME** control. SEC appears in the display.
3. Press the **∧** button and button numbered 1 simultaneously. - - - - appears in the display.
4. Press button numbered 1 repeatedly to increase the value for the first user ID digit. Likewise, buttons numbered 2, 3 and 4 correspond to the second, third and fourth digits. Set each digit by pressing the corresponding button repeatedly until the chosen user ID is complete.

5. Press and hold the **PTY** button for approx. 2 seconds to enter the chosen user ID. SEC appears again in the display and the unit switches off automatically.

Entering the 4-digit security ID

After reinstalling the infotainment system or reconnecting the vehicle battery, the 4-digit security ID must be entered. SEC appears in the display when the system is switched on.

This does not happen if the system is switched off and on again within 20 seconds.

To enter the user ID:

1. Press the **Λ** button and button numbered 1 simultaneously. ---- appears in the display.
2. Repeatedly press buttons numbered 1, 2, 3 and 4 which correspond to the digits of the user ID, until the correct stored user ID is displayed.
3. Press and hold the **PTY** button for approx. 2 seconds. The unit switches off automatically.

Switch the unit back on to operate: the system starts in radio mode. If the wrong user ID is entered 10 times, HELP appears in the display and the system will not operate. Seek the assistance of a workshop. Also, if the user ID is lost, seek the assistance of a workshop.

Deleting 4-digit security ID

The stored user ID can be erased and a new ID set at any time.

To delete the existing user ID, repeat steps 1 to 3 in "Setting a new 4-digit security ID", then:

1. Repeatedly press buttons numbered 1, 2, 3 and 4 which correspond to the digits of the user ID, until the correct stored user ID is displayed.
2. Press and hold the **PTY** button for approx. 2 seconds. ---- appears in the display and the unit switches off automatically.

Set a new user ID as described in "Setting a new 4-digit security ID".

Operation

Switching on and off

Press the **VOLUME** control.

Setting the volume

Turn the **VOLUME** control.

Mute function

Press the **MUTE** button. In CD mode, playback is paused. Press any button to cancel the mute function.

Sound settings

Press the **SOUND** button to enter the sound settings menu. When this button is pressed repeatedly the settings appear in the following order:

- **BAS** - Bass
- **TRE** - Treble
- **BAL** - Balance
- **FAD** - Fader
- **AVC** - Auto volume control

To adjust the displayed sound setting, press button **Λ** or **V**.

Press the **SOUND** button to exit.

Auto Volume Control

The AVC function automatically adjusts volume depending on vehicle speed to compensate for road noise. In the sound settings menu, three levels can be selected or the function can be switched off.

Radio

AM-FM radio

AM (Long Wave and Medium Wave) and FM (Frequency Modulation) wavebands can be selected. Manual and automatic storing facilities are available on each wavebands to store stations that can be recalled using the preset buttons 1-6.

Radio mode

Press the **FM/AM** button. Wavebands appear in the following order when the button is pressed repeatedly: FM1, FM2, LW, MW1, MW2.

Automatic search

Press and hold the \wedge or \vee button for approx. 1 second. The next receivable radio station on the selected waveband will be found. If AF has been switched on previously, only RDS stations will be found.

Station memory

In each waveband, 6 stations can be stored under preset station memory locations 1-6.

Storing stations manually

Tune to the desired waveband and station. Press and hold the preset station button (1-6) where the selected station is to be stored, for approx. 2 seconds. Previously stored stations are overwritten.

Storing stations automatically

Tune to the desired waveband. Press and hold the **AST** button for approx. 2 seconds. 6 stations with strong signals are automatically stored under preset station memory locations 1-6. Previously stored stations are overwritten. If AF is on, only RDS stations will be found.

If less than 6 stations with strong signals can be received, the number of preset stations may be less than 6.

If no stations with strong signals can be received, previously stored stations are reset.

To exit automatic storing while storing is in progress, press the **AST** button again. Previously stored stations are not overwritten.

Selecting stored stations

Tune to the desired waveband and press the relevant preset station button.

If a station is not stored on the selected button, - - - will appear in the display.

Radio data system (RDS)

RDS is a service which helps search for the required FM station.

RDS stations transmit information which is automatically evaluated by an RDS radio. In some areas, other functions associated with RDS are available, e.g. REG - Regionalisation and TA - Traffic Announcement.

AF - Alternative Frequency

An RDS program is transmitted on several frequencies simultaneously. When AF is on, the system automatically searches for the strongest receivable frequency.

REG - Regionalisation

Some RDS stations transmit different regional programs over different frequencies at certain times. With REG on, when searching for the frequency of a radio program with the strongest reception using AF, the radio always remains tuned to the selected regional program. With REG off, when searching for the frequency of a radio program with the strongest reception using AF, the radio does not consider regional programs.

Switching AF and REG on and off

Settings appears in the following order when the **AF** button is pressed repeatedly:

- AF on/REG off
- AF on/REG on
- AF off/REG off

AF and/or REG appears in the display when active.

PTY - Program Type

Many RDS stations transmit a PTY code that indicates the type of program being broadcast, e.g. News or Sport. The PTY code enables selection of the station according to program type.

Searching for stations by program type

Press the **PTY** button to select PTY mode. Turn the **VOLUME** control to select the desired program type. Press the **^** button or **v** button to begin search. If no station within the selected PTY code is received, **NOTHING** appears in the display followed by **PTY**. Select another **PTY** as described above.

TA - Traffic Announcement

Traffic stations are RDS stations which transmit traffic information. With **TA** on, the system searches for stations emitting **TP** - Traffic Programs and tunes into these stations in preference to others.

When TA is active and a Traffic Program is currently being received, playback is interrupted for the traffic announcement and resumes when the announcement ends.

Switching TA on and off

Press the **TA** button to switch on traffic announcements. TA appears in the display. When a Traffic Program is currently being received, TP also appears in the display. Press the button again to switch off.

To search for a TP station - TP SEEK, while TA is active, press the **∧** or **∨** button.

If TP data is not received within approx. 20 seconds after TA is switched on, TP SEEK automatically takes place only once. If no TP station is received, NOTHING appears in the display.

PS - Program Service Name

Display of program name instead of station frequency.

EON - Enhanced OtherNetworks

With EON, traffic reports will be received, even if the set station does not transmit its own traffic information. When a traffic announcement is made, the unit switches to a traffic information station linked to EON. When EON is active, EON appears in the display.

Radio reception

Radio reception may be disrupted by static, noise, distortion or loss of reception due to:

- changes in distance from the transmitter,
- multi-path reception due to reflection,
- shadowing.

Audio players

CD player

The CD player can play audio CDs and, if equipped, MP3 CDs. The CD type is automatically recognised.

Caution

Do not insert DVDs, small diameter single CDs and CDs with irregular shapes into the unit. They may become jammed or damage the mechanism.

The system may not be able to play CD-Rs or play them properly. CD-RW discs cannot be played back.

CD/MP3 playback

With a CD already inserted, press the **CD** button.

To insert a CD, place the audio CD into the slot with the printed side upwards until it automatically retracts. CD playback begins and CD IN appears in the display.

Selecting next or previous track

Press the **∧** button to skip to the next track and the **∨** button to skip to the previous track.

Fast forwards/backwards search

Press and hold the **∧** button to fast forward and the **∨** button to fast rewind through the current track.

Repeat play

Press the **RPT** button to play the current track repeatedly. **RPT** appears in the display. Press button again to switch off.

Random play

Press the **RDM** button to play the tracks on the disc in random order. **RDM** appears in the display. Press button again to switch off.

Scan CD

Press the **SCN** button to play the first few seconds of each track on the disc. **SCN** appears in the display. Press button again to switch off.

Selecting next or previous MP3 folder

If the MP3 CD consists of several folders, press the **DISC/FLD+** button to skip to the next folder and the **-DISC/FLD** button to skip to the previous folder.

Displaying MP3 text

MP3 text types appear when the **TEXT** button is pressed repeatedly:

- Elapsed time
- Folder name
- File name

Press the **TEXT** button for approx. 2 seconds to enable scrolling text.

Removing CDs

Press the **▲** button. The CD ejects.

Maintenance and care

- If **ERROR 1** appears in the display, the disc cannot be read.
- If **ERROR 3** appears in the display, the player has developed an unidentified error. The inserted disc may not eject. Seek the assistance of a workshop.

Phone

Mobile phones and CB radio equipment

Installation instructions and operating guidelines

The vehicle specific installation instructions and the operating guidelines of the mobile phone and handsfree manufacturer must be observed when installing and operating a mobile telephone. Failure to do so could invalidate the vehicle type approval (EU directive 95/54/EC).

Recommendations for fault-free operation:

- Professionally installed exterior antenna to obtain the maximum range possible,
- Maximum transmission power 10 watts,
- Installation of the phone in a suitable spot, consider relevant Note ↻ 33.

Seek advice on predetermined installation points for the external antenna or equipment holder and ways of using devices with a transmission power exceeding 10 watts.

Use of a handsfree attachment without external antenna with mobile telephone standards GSM 900/1800/1900 and UMTS is only permitted if the maximum transmission power of the mobile telephone is 2 watts for GSM 900 or 1 watt for the other types.

For reasons of safety, do not use the phone while driving. Even use of a handsfree set can be a distraction while driving.

Warning

Operation of radio equipment and mobile telephones which fail to meet above mentioned mobile telephone standards is only permitted using an antenna located outside of the vehicle.

Caution

Mobile telephones and radio equipment may lead to malfunctions in the vehicle electronics when operated inside the vehicle with no exterior antenna, unless the above mentioned regulations are observed.

Climate control

Climate control systems	78
Air vents	80
Maintenance	81

Climate control systems

Heating and ventilation system



Controls for:

- Temperature
- Air distribution
- Fan speed





Heated rear window  ⇨ 27.

Temperature

red = warm
blue = cold

Heating will not be fully effective until the engine has reached normal operating temperature.

Air distribution

-  = to head area via adjustable air vents
-  = to head area via centre and side air vents and to foot well
-  = to foot well
-  = to windscreen, front door windows, side air vents and to foot well
-  = to windscreen, front door windows and side air vents

Fan speed

Adjust the air flow by switching the fan to the desired speed.

Air conditioning system



Cooling

Operated with the  button and functional only when the engine and fan are running.

The air conditioning system cools and dehumidifies (dries) when outside temperature is a little above the freezing point. Therefore condensation may form and drip from under the vehicle.

If no cooling or drying is required, switch the cooling system off to save fuel.

Air recirculation system

Operated with the  button.



Warning

The exchange of fresh air is reduced in air recirculation mode. In operation without cooling the air humidity increases, so the windows may mist up. The quality of the passenger compartment air deteriorates, which may cause the vehicle occupants to feel drowsy.

Maximum cooling





Briefly open the windows so that hot air can disperse quickly.

- Cooling  on.
- Air recirculation system  on.
- Set air distribution control to .
- Set temperature control to coldest level.
- Set fan speed to highest level.
- Open all vents.

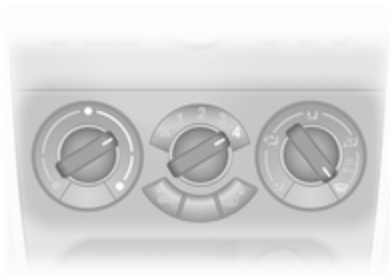
Demisting and defrosting the windows



- Set air distribution control to .
- Set temperature control to warmest level.
- Set fan speed to highest level.
- Switch on heated rear window .
- Open side air vents as required and direct them towards the door windows.

Air vents

Adjustable air vents

At least one air vent must be open while cooling is on in order to prevent the evaporator from icing up due to lack of air movement.



The air flow can be directed as desired by tilting the slats up, down and sideways using the central adjuster.

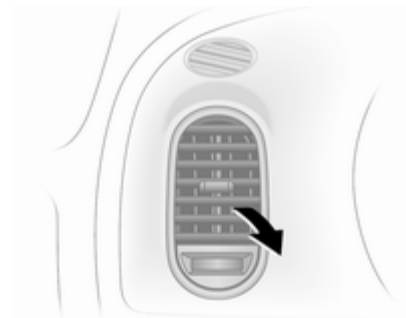

Direct the air flow by tilting the slats and turning the adjuster wheel left or right.

To open or close the vent, turn the adjuster wheel to the left or the right.

Fixed air vents

Additional air vents are located beneath the windscreen and door windows and in the foot wells.

Maintenance

Air intake

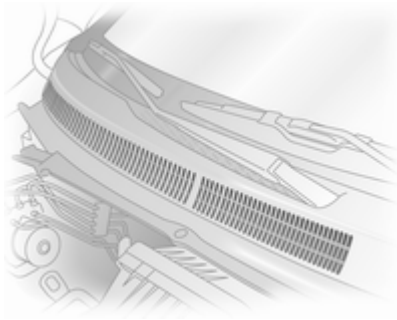

The air intake in front of the windscreen in the engine compartment must be kept clear to allow air intake. Remove any leaves, dirt or snow.

Pollen filter

The pollen filter cleans dust, soot, pollen and spores from the air entering the vehicle through the air intake.

Air conditioning regular operation

In order to ensure continuously efficient performance, cooling must be operated for a few minutes once a month, irrespective of the weather and time of year. Operation with cooling is not possible when outside temperature is too low.

Service

For optimal cooling performance, it is recommended to annually check the climate control system, starting three years after initial vehicle registration, including:

- Functionality and pressure test
- Heating functionality
- Leakage check
- Check of drive belts
- Cleaning of condenser and evaporator drainage
- Performance check

Driving and operating

Driving hints	82
Starting and operating	82
Engine exhaust	84
Automatic transmission	86
Manual transmission	88
Brakes	88
Ride control systems	90
Fuel	91

Driving hints

Control of the vehicle

Never coast with engine not running

Many systems will not function in this situation (e.g. brake servo unit, power steering). Driving in this manner is a danger to yourself and others.

Pedals

To ensure the pedal travel is uninhibited, there must be no mats in the area of the pedals.

Starting and operating

New vehicle running-in

Do not brake unnecessarily hard for the first few journeys.

During the first drive, smoke may occur because of wax and oil evaporating off the exhaust system. Park the vehicle in the open for a while after the first drive and avoid inhaling the fumes.

Fuel and engine oil consumption may be higher during the running-in period.

Ignition switch positions



- LOCK** = Ignition off
ACC = Steering wheel lock released, ignition off
ON = Ignition on, for diesel engine: preheating
START = Starting

Starting the engine



- Manual transmission: operate clutch;
 Automatic transmission: operate brake and move selector lever in **P** or **N**;
 Do not accelerate;
 Diesel engine: turn the key to position **ON** for preheating until control indicator  goes out;
 Turn key to position **START** and release.
 Start attempts should not last longer than 15 seconds. If engine does not start, wait 15 seconds before

repeating starting procedure. If necessary, depress accelerator before repeating starting procedure. Before restarting or to switch off the engine, turn key back to **LOCK**.

Overrun cut-off

The fuel supply is automatically cut off during overrun, i.e. when the vehicle is driven with a gear engaged but accelerator is released.

Parking

- Do not park the vehicle on an easily ignitable surface. The high temperature of the exhaust system could ignite the surface.
- Always apply parking brake without pressing release button. Apply as firmly as possible on downhill or uphill slopes. Depress the foot brake at the same time to reduce operating force.
- Switch off the engine and ignition. Push key into ignition switch before turning to **LOCK** position and removing (vehicles with automatic

transmission: depress foot brake and shift into P). Turn the steering wheel until the steering wheel lock engages.

- If the vehicle is on a level surface or uphill slope, engage first gear or set the selector lever to **P** before switching off the ignition. On an uphill slope, turn the front wheels away from the kerb.

If the vehicle is on a downhill slope, engage reverse gear or set the selector lever to **P** before switching off the ignition. Turn the front wheels towards the kerb.

- Lock the vehicle and activate the mechanical anti-theft locking system.

Engine exhaust

Danger

Engine exhaust gases contain poisonous carbon monoxide, which is colourless and odourless and could be fatal if inhaled.

If exhaust gases enter the interior of the vehicle, open the windows. Have the cause of the fault rectified by a workshop.

Avoid driving with an open load compartment, otherwise exhaust gases could enter the vehicle.

Diesel particle filter

The diesel particle filter system filters harmful soot particles out of the exhaust gases. The system includes a self-cleaning function that runs automatically during driving. The filter is cleaned by burning off the soot particles at high temperature. This process takes place automatically under set driving conditions and may

take up to 30 minutes. Fuel consumption may be higher during this period. The emission of smells and smoke during this process is normal.



Under certain driving conditions, e.g. short distances, the system cannot clean itself automatically.

If control indicator  illuminates, you should continue driving, and as soon as the road and traffic situation permits it, increase speed to more than 75 km/h (50 mph) and diesel particle filter cleaning will start.

Stopping the journey or switching off the engine during cleaning is not recommended.

Caution

If the cleaning process is interrupted more than once, there is a great risk of provoking severe engine damage.

Cleaning takes place quickest at high engine speeds and loads. The control indicator  extinguishes as soon as the self-cleaning operation is complete.





If regeneration of the diesel particle filter is not successful or possible, control indicator  may illuminate and the vehicle goes into limp home mode: interrupt your journey and seek the assistance of a workshop immediately.

Catalytic converter

The catalytic converter reduces the amount of harmful substances in the exhaust gas.

Caution

Fuel grades other than those listed on pages ,  91,  132 could damage the catalytic converter or electronic components.

Unburnt petrol will overheat and damage the catalytic converter. Therefore avoid excessive use of the starter, running the fuel tank dry and starting the engine by pushing or towing.

In the event of misfiring, uneven engine running, a reduction in engine performance or other unusual problems, have the cause of the fault rectified by a workshop as soon as possible. In an emergency, driving can be continued for a short period, keeping vehicle speed and engine speed low.

If the control indicator  illuminates while driving, the permitted emission limits may be exceeded. Seek the assistance of a workshop immediately.

Malfunction indicator light   59.

Automatic transmission

The automatic transmission permits automatic gearshifting.

Transmission display

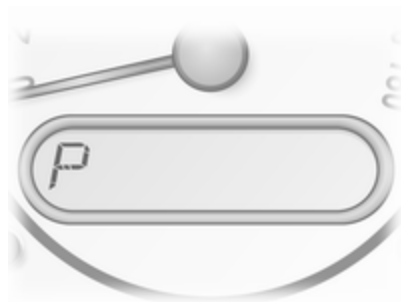

The mode or selected gear is shown in the transmission display.

Selector lever

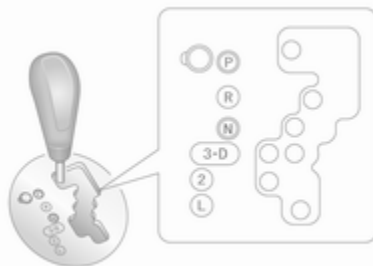

- P** = park position, wheels are locked, engage only when the vehicle is stationary and the parking brake is applied
- R** = reverse gear, engage only when vehicle is stationary
- N** = neutral
- D** = automatic mode with all gears

The selector lever is locked in **P** and can only be moved when the ignition is on and the brake pedal is applied.

To engage **P** or **R**, push the release button on selector lever.

The engine can only be started with lever in position **P** or **N**. When position **N** is selected, press brake pedal or apply parking brake before starting.

Do not accelerate while engaging a gear. Never depress the accelerator pedal and brake pedal at the same time.

When a gear is engaged, the vehicle slowly begins to creep when the brake is released.

Gears 3, 2, L

3, 2, L = Transmission does not shift above the selected gear.

Press button on selector lever to engage **3** or **L**.

Only select **3**, **2** or **L** to prevent automatic upshifting or as an aid in engine braking.

Engine braking

To utilise the engine braking effect, select a lower gear in good time when driving downhill.

Rocking the vehicle

Rocking the vehicle is only permissible if the vehicle is stuck in sand, mud or snow. Move the selector lever between **D** and **R** in a repeat pattern. Do not race the engine and avoid sudden acceleration.

Parking

Apply the parking brake and engage **P**.

The ignition key can only be removed when the selector lever is in position **P**.

Kickdown

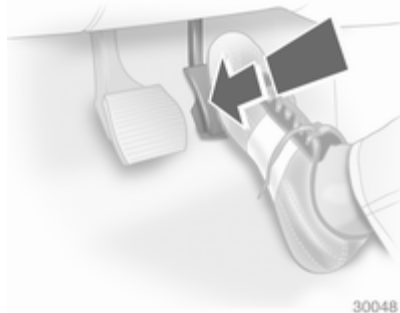

30048

If the accelerator pedal is pressed past the pressure point, the transmission shifts to a lower gear depending on engine speed.

Fault

In the event of a fault,  flashes. The transmission no longer shifts automatically.

Have the cause of the fault remedied by a workshop.

Interruption of power supply

In the event of an interruption of power supply, the selector lever cannot be moved out of the **P** position.

If the battery is discharged, start the vehicle using jump leads ⇨ 118.

If the battery is not the cause of the fault, release selector lever:

1. Apply parking brake.

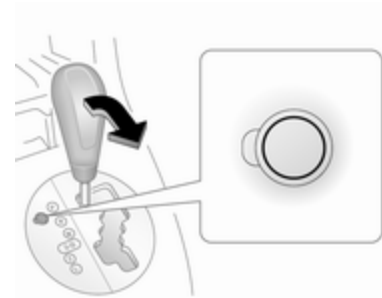

2. Remove cap concealing release button.
3. Push the button with a screwdriver and move the selector lever out of **P**. If **P** is engaged again, the selector lever will be locked in position again. On variants with **SHIFT LOCK** button, push button and move selector lever. Have the cause of the power supply interruption remedied by a workshop.
4. Refit release button cap.

Manual transmission



Reverse: with the vehicle stationary, wait 3 seconds after depressing the clutch before engaging gear.

If the gear does not engage, set the lever in neutral, release the clutch pedal and depress again; then repeat gear selection.

Do not grind the clutch unnecessarily.

When operating, depress the clutch pedal completely. Do not use the pedal as a foot rest.

Caution

It is inadvisable to drive with hand resting on the selector lever.

Brakes

The brake system comprises two independent brake circuits.

If a brake circuit fails, the vehicle can still be braked using the other brake circuit. However, braking effect is achieved only when you depress the brake pedal firmly. You need to use considerably more force for this. The braking distance is extended. Seek the assistance of a workshop before continuing your journey.

When the engine is not running, the support of the brake servo unit disappears once the brake pedal has been depressed once or twice. Braking effect is not reduced, but braking requires significantly greater force. It is especially important to bear this in mind when being towed.

Control indicator (ⓘ) ⇨ 59.

Antilock brake system

Antilock brake system (ABS) prevents the wheels from locking.

ABS starts to regulate brake pressure as soon as a wheel shows a tendency to lock. The vehicle remains steerable, even during hard braking.

ABS control is made apparent through a pulse in the brake pedal and the noise of the regulation process.

For optimum braking, keep the brake pedal fully depressed throughout the braking process, despite the fact that the pedal is pulsating. Do not reduce the pressure on the pedal.

Control indicator (ABS) ⇨ 60.

Fault

Warning

If there is a fault in the ABS, the wheels may be liable to lock due to braking that is heavier than normal. The advantages of ABS are no longer available. During hard braking, the vehicle can no longer be steered and may swerve.

Have the cause of the fault remedied by a workshop.

Parking brake

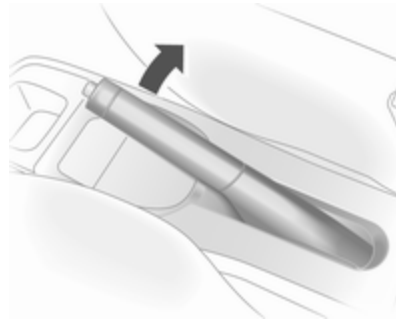

Always apply parking brake firmly without operating the release button, and apply as firmly as possible on a downhill or uphill slope.

To release the parking brake, pull the lever up slightly, press the release button and fully lower the lever.

To reduce the operating forces of the parking brake, depress the foot brake at the same time.

Control indicator (P) ⇨ 59.

Brake assist

If the brake pedal is depressed quickly and forcefully, maximum brake force is automatically applied (full braking).

Maintain steady pressure on the brake pedal for as long as full braking is required. Maximum brake force is automatically reduced when the brake pedal is released.

Ride control systems

Traction Control system

Traction Control system (TC) is a component part of the Electronic Stability Program (ESP®) which improves driving stability when necessary, regardless of the type of road surface or tyre grip, by preventing the drive wheels from spinning.

As soon as the drive wheels starts to spin, engine output is reduced and the wheel spinning the most is braked individually. This considerably improves the driving stability of the vehicle on slippery road surfaces.

TC is operational as soon as the control indicator  extinguishes.

When TC is active  flashes.

Warning

Do not let this special safety feature tempt you into taking risks when driving.

Adapt speed to the road conditions.

Control indicator  \rightarrow 60.

Deactivation



TC can be switched off when spinning of drive wheels is required: press button **TCSS OFF**.

Control indicator **TCSS OFF** illuminates.

TC is reactivated by pressing the **TCSS OFF** button again.

Control indicator **TCSS OFF** \rightarrow 60.

Electronic stability program

Electronic Stability Program (ESP®) improves driving stability when necessary, regardless of the type of road surface or tyre grip. It also prevents the drive wheels from spinning.

As soon as the vehicle starts to swerve (understeer/oversteer), engine output is reduced and the wheels are braked individually. This considerably improves the driving stability of the vehicle on slippery road surfaces.

ESP® is operational as soon as control indicators  **ESP** and **TCSS OFF** extinguish.

When ESP® comes into action  flashes.

⚠ Warning

Do not let this special safety feature tempt you into taking risks when driving.

Adapt speed to the road conditions.

Control indicator   60.

Fuel**Fuel for petrol engines**

Only use unleaded fuel that complies with DIN EN 228.

Fuels with ethanol content greater than 5% may only be used if the vehicle has been specifically developed and approved for these fuels.

Use fuel with the recommended octane rating  132. Use of fuel with too low an octane rating can reduce engine power and torque and slightly increases fuel consumption.

If the RON 95 label is attached to the tank flap, unleaded fuel with an octane rating of 95 or higher must be used.

Caution

Use of fuel with too low an octane rating could lead to uncontrolled combustion and engine damage.

Fuel for diesel engines

Only use diesel fuel that complies with DIN EN 590. The fuel must have low sulphur content (max. 50 ppm). Equivalent standardised fuels with a biodiesel (= FAME according to EN14214) content of max. 7% by volume (like DIN 51628 or equivalent standards) may be used.

Do not use marine diesel oils, heating oils or entirely or partially plant-based diesel fuels, such as rape seed oil or bio diesel, Aquazole and similar diesel-water emulsions. Diesel fuels must not be diluted with fuels for petrol engines.

The flow and filterability of diesel fuel are temperature-dependent. When temperatures are low, refuel with diesel fuel with guaranteed winter properties.

Refuelling

⚠ Danger

Before refuelling, switch off engine and any external heaters with combustion chambers (identified by sticker on fuel filler flap). Switch off any mobile phones.

Follow the operating and safety instructions of the filling station when refuelling.

⚠ Danger

Fuel is flammable and explosive. No smoking. No naked flames or sparks.

If you can smell fuel in your vehicle, have the cause of this remedied immediately by a workshop.

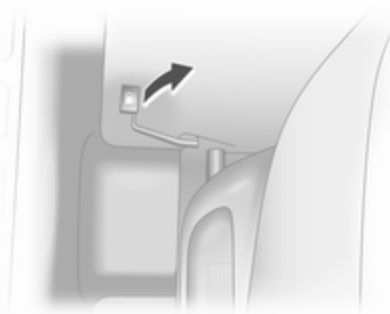

The fuel filler flap is opened by pulling up the release lever located on the outboard side of the driver's seat.



To open fuel filler cap: turn it anticlockwise.

Caution

Wipe off any overflowing fuel immediately.

Fuel filler cap

Only a genuine fuel filler cap provides full functionality. Diesel-engined vehicles have special fuel filler caps.

Fuel consumption - CO₂-Emissions

The determination of fuel consumption is regulated by European directive 80/1268/EEC (latest edition 2004/3/EC).

The directive is oriented to actual driving practices: Urban driving is rated at approx. $\frac{1}{3}$ and extra urban driving with approx. $\frac{2}{3}$. Cold starts and acceleration phases are also taken into consideration.

The specification of CO₂ emission is also a constituent of the directive.

The figures given must not be taken as a guarantee for the actual fuel consumption of a particular vehicle. Furthermore, fuel consumption is dependent on personal driving style as well as road and traffic conditions.

All values are based on the EU base model with standard equipment.

The calculation of fuel consumption takes account of the vehicle's kerb weight, ascertained in accordance with the regulations. Optional equipment may result in slightly higher fuel consumption and CO₂ emission levels and a lower maximum speed.

Fuel consumption, CO₂ emissions

⇨ 133.

Vehicle care

General Information	94
Vehicle checks	95
Bulb replacement	100
Electrical system	104
Vehicle tools	108
Wheels and tyres	109
Jump starting	118
Towing	119
Appearance care	121

General Information

Accessories and vehicle modifications

We recommend using Genuine Parts and Accessories and factory approved parts specific for your vehicle type. We cannot assess or guarantee reliability of products - even if they have a regulatory or otherwise granted approval.

Do not make any modifications to the electrical system, e.g. changes of electronic control units (chip tuning).

Vehicle storage

Storage for a long period of time

If the vehicle is to be stored for several months:

- Wash and wax the vehicle.
- Have the wax in the engine compartment and underbody checked.
- Clean and preserve rubber seals.
- Change engine oil.

- Drain washer fluid reservoir.
- Check coolant antifreeze and corrosion protection.
- Adjust tyre pressure to the value specified for full load.
- Park vehicle in a dry, well ventilated place. Engage first or reverse gear or set selector lever to **P**. Prevent the vehicle from rolling.
- Do not apply parking brake.
- Open bonnet, close all doors and lock the vehicle.
- Disconnect the clamp from the negative terminal of the vehicle battery. Beware that all systems are not functional.

Putting back into operation

When the vehicle is to be put back into operation:

- Connect the clamp to the negative terminal of the vehicle battery. Activate the electronics of the power windows.
- Check tyre pressure.
- Fill up the washer fluid reservoir.

- Check the engine oil level.
- Check the coolant level.
- Fit the number plate if necessary.

End-of-life vehicle recovery

Information on end-of-life vehicle recovery centres and the recycling of end-of-life vehicles is available on our website. Only entrust this work to an authorised recycling centre.

Vehicle checks

Performing work

Warning

Only perform engine compartment checks when the ignition is off.
The cooling fan may start operating even if the ignition is off.

Danger

The ignition system use extremely high voltage. Do not touch.

Bonnet

Opening

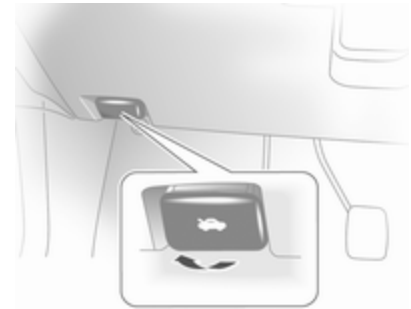

Pull the release lever and return it to its original position.

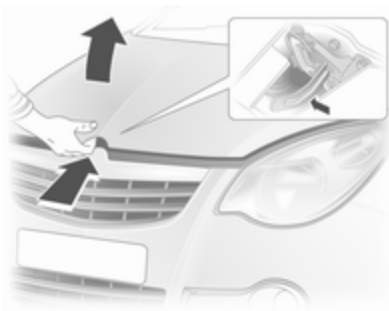

Locate the safety catch on the underside of the bonnet, push the catch to the left and lift the bonnet.
Air intake ⇨ 81.

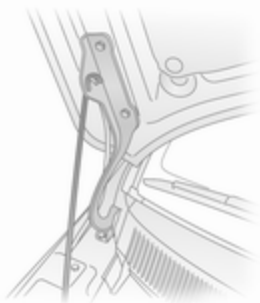

Secure the bonnet support.

Closing

Before closing the bonnet, press the support into the holder.

Lower the bonnet and allow it to drop into the catch. Check that the bonnet is engaged.

Engine oil

It is advisable to check the engine oil level manually before embarking on a long journey.

Check with the vehicle on a level surface. The engine must be at operating temperature and switched off for at least 5 minutes.

Pull out the dipstick, wipe it clean, insert it to the stop on the handle, pull out and read the engine oil level.

Caution

It is the owner's responsibility to maintain the proper level of an appropriate quality oil in the engine.

Insert dipstick to the stop on the handle.



Different dipsticks are used depending on engine variant.

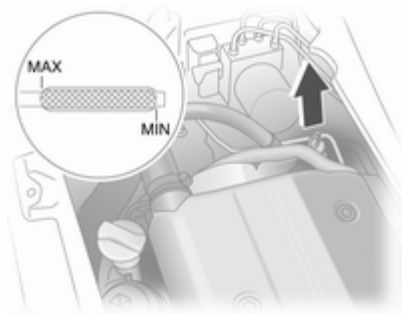

When the engine oil level has dropped to the **MIN** mark, top up engine oil.

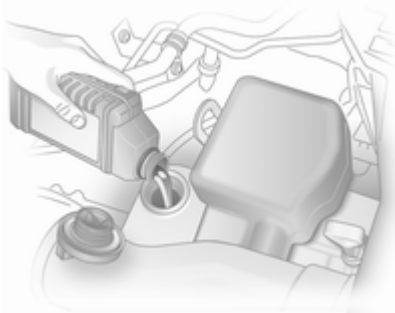

We recommend the use of the same type of engine oil that was used at the last change.

The engine oil level must not exceed the **MAX** mark on the dipstick.

Caution

Overfilled engine oil must be drained or suctioned out.

Capacities ⇨ 135, Change engine oil ⇨ 61.

Fit the cap on straight and tighten it.

Engine coolant

The coolant provides freeze protection down to approx. -28 °C.

Caution

Only use approved antifreeze.

Coolant level

The illustrations show the **LOW** and **FULL** coolant level marks in the petrol and diesel engines respectively.

Caution

Too low a coolant level can cause engine damage.



If the cooling system is cold, the coolant level should be between the **FULL/LOW** marks. Top up if the level is low.

Different reservoirs are used depending on engine variant.

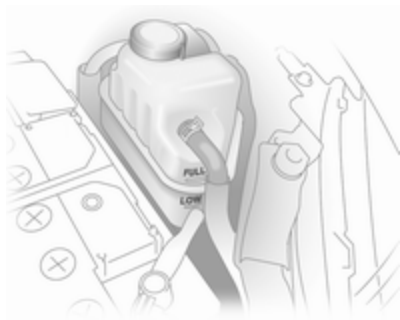

⚠ Warning

Allow the engine to cool before opening the cap. Carefully open the cap, relieving the pressure slowly.

Top up with antifreeze. If no antifreeze is available, use clean tap water or distilled water. Install the cap tightly. Have the antifreeze concentration checked and have the cause of the coolant loss remedied by a workshop.

Washer fluid

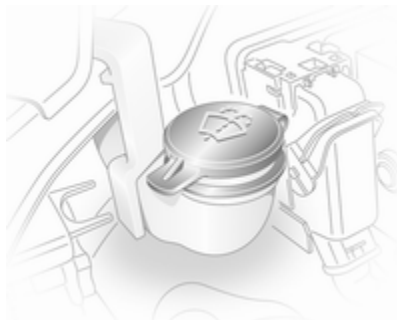

Fill with clean water mixed with a suitable quantity of windscreen washer fluid which contains antifreeze.

Brakes

A squealing noise indicates that the brake lining is at its minimum thickness. Continued driving is possible but have the brake lining replaced as soon as possible.

Once new brake linings are installed, do not brake unnecessarily hard for the first few journeys.

Brake fluid

⚠ Warning

Brake fluid is poisonous and corrosive. Avoid contact with eyes, skin, fabrics and painted surfaces.

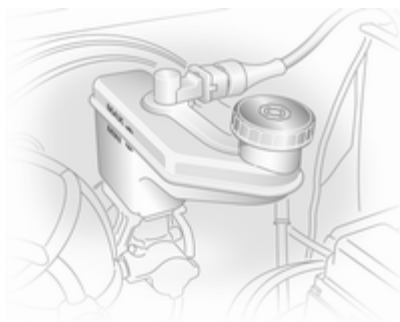

The brake fluid level must be between the **MIN** and **MAX** marks.

When topping up, ensure maximum cleanliness as contamination of the brake fluid can lead to brake system malfunctions. Have the cause of the loss of brake fluid remedied by a workshop.

Only use high-performance brake fluid approved for your vehicle.

Brake and clutch fluid ↗ 128.

Battery

The vehicle battery is maintenance-free.

Batteries do not belong in household waste. They must be disposed of at an appropriate recycling collection point.

Laying up the vehicle for more than 4 weeks can lead to battery discharge. Disconnect the clamp from the negative terminal of the vehicle battery.

Ensure the ignition is switched off before connecting or disconnecting the vehicle battery.

Control indicator  illuminates in the instrument cluster then extinguishes after the engine is started when the electric throttle body system has been correctly calibrated.

Diesel fuel system bleeding

If the tank has been run dry, the diesel fuel system must be bled. With vehicle stationary, turn key to ignition switch position **ON** for more than 5 seconds, then turn to **START**. If engine does not start, wait approx. 15 seconds before repeating starting procedure. If the engine will still not start, seek the assistance of a workshop.

Wiper blade replacement

Wiper blades on the windscreen

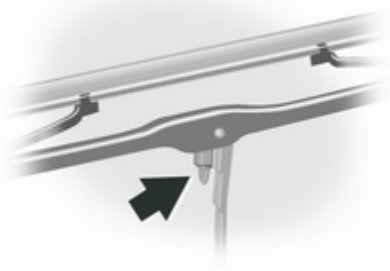

Lift wiper arm, press retaining clip towards wiper arm and detach wiper blade.

Wiper blade on the rear window

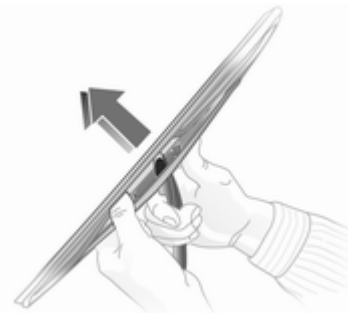

Lift wiper arm. Disengage wiper blade as shown in illustration and remove.

Bulb replacement

Switch off the ignition and turn off the relevant switch or close the doors.

Only hold a new bulb at the base! Do not touch the bulb glass with bare hands.

Use only the same bulb type for replacement.

Battery removal

Diesel engines: for headlight bulb replacement on the battery side, it is necessary to first disconnect and remove the battery then remove the coolant expansion tank and fuse box.

1. Switch off ignition and exterior lights.
2. Open bonnet and disconnect battery by detaching negative (-) terminal followed by positive (+) terminal.

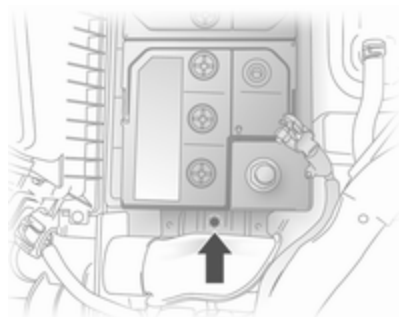

3. Unscrew the retaining bolt using a suitable tool and remove battery, coolant expansion tank and fuse box.

When reinstalling the battery, reconnect the positive (+) terminal first and then the negative (-) terminal.

Halogen headlights

Low beam and high beam

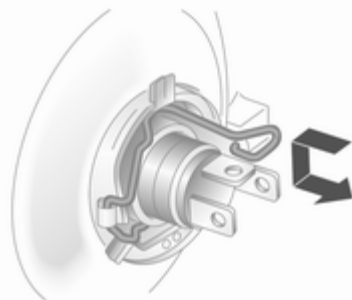

1. Remove headlight protective cover.
2. Detach plug connector from bulb.
3. Push retaining spring wire clip forward and unhook it.
4. Remove bulb from reflector housing and pull bulb straight out of socket.
5. Insert new bulb by pushing in and install in reflector housing.

- Engage spring wire clip, and reattach plug connector to bulb.
- Replace headlight protective cover.

Sidelights

- Remove headlight protective cover.

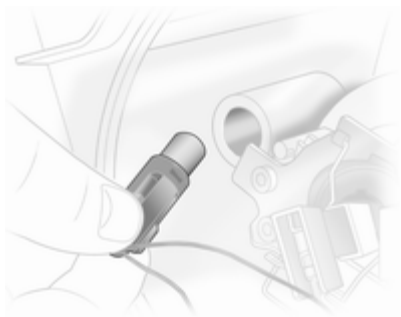

- Withdraw sidelight bulb holder from reflector.
- Remove bulb from socket and renew bulb.
- Insert new bulb by pushing in.
- Insert holder in reflector. Replace headlight protective cover.

Fog lights

Have bulbs replaced by a workshop.

Front turn signal lights

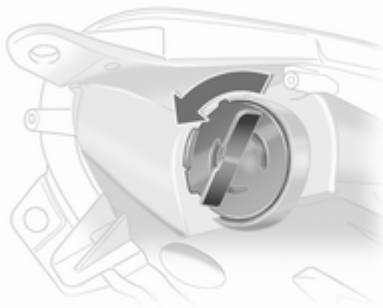

- Rotate bulb holder anti-clockwise to disengage.

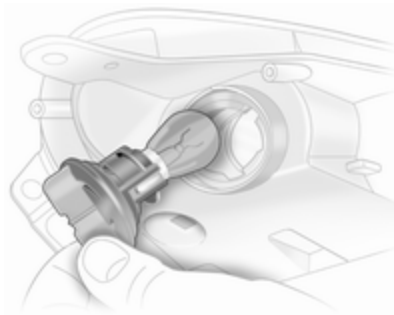

- Push bulb into socket slightly, rotate anti-clockwise, remove and renew bulb.
- Insert bulb holder in reflector, rotate clockwise to engage.

Tail lights

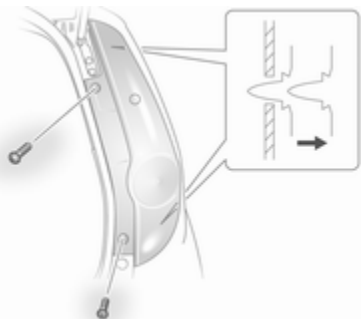

1. Open tailgate.
2. Remove both screws on rear light assembly.
3. Pull light assembly away from vehicle, towards the rear.
4. Push bulb into socket slightly, rotate anti-clockwise and remove.
5. Insert new bulb.

6. Replace light assembly in original position, ensuring the upper and lower lugs are seated correctly.
7. Replace both screws on rear combination light assembly and close tailgate.

Side turn signal lights

Have bulbs replaced by a workshop.

Centre high-mounted brake light

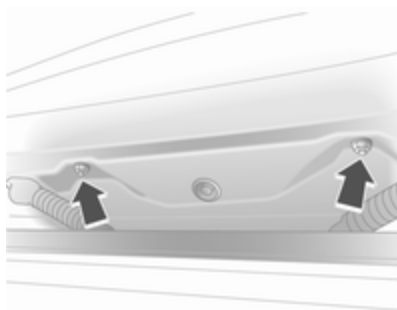

1. Open tailgate and remove both bolts on underside of tailgate.

2. Close tailgate.
3. Remove light assembly from tailgate.

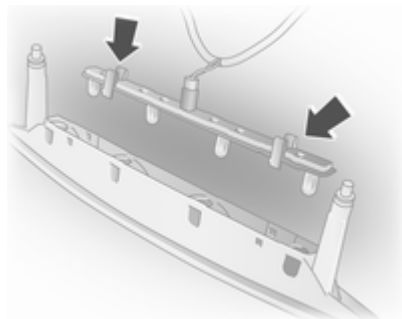

4. Pinch both prongs on bulb holder together simultaneously and remove bulb holder from light assembly.
5. Remove bulbs by pulling them straight out.
6. Insert new bulbs by pushing them in.

- Replace bulb holder in light assembly and install light assembly in tailgate.
- Open tailgate and replace bolts removed earlier.

Number plate light



- Remove bulb holder by twisting it and pulling it away from the vehicle.
- Remove bulb by pulling straight out.
- Install new bulb by pushing in.
- Replace bulb holder in original position.

Interior lights

Front courtesy light



- Using a suitable screwdriver covered by a cloth, pry lens away from headlining.
- Remove bulb by pulling straight out.
- Insert new bulb, ensuring contact springs hold the bulb securely.
- Install lens in headlining by pushing it back into original position.

Load compartment light



- Pry the light out with a screwdriver.
- Press bulb slightly towards spring clip and remove.
- Insert new bulb.
- Install light.

Instrument panel illumination

Have bulbs replaced by a workshop.

Electrical system

Fuses

Data on the replacement fuse must match the data on the defective fuse.

There are two fuse boxes in the vehicle:

- on the left-hand side of the vehicle below the instrument panel,
- in the engine compartment located next to the battery.

Before replacing a fuse, turn off the respective switch and the ignition.

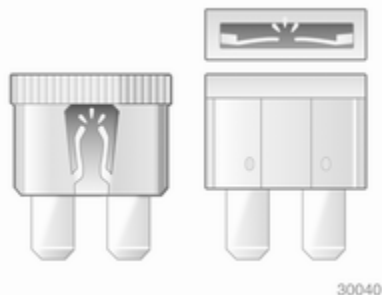

A blown fuse can be recognised by its melted wire. Do not replace the fuse until the cause of the fault has been remedied.

Spare fuses can be kept in the engine compartment fuse box.

Some functions are protected by several fuses.

Fuses may also be inserted without existence of a function.

Fuse extractor

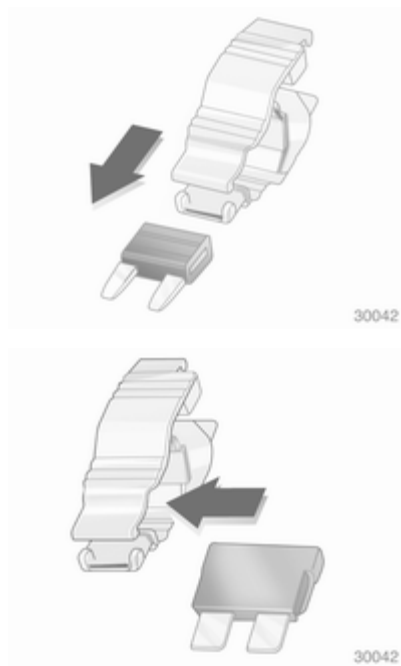



30044

To help in replacing fuses, a fuse extractor is located in the fuse box.

Place the fuse extractor on the various types of fuse from the top or side, and withdraw fuse.

Engine compartment fuse box

Petrol engines



The fuse box is located next to the battery in the engine compartment. Disengage the cover and tilt upwards to open.

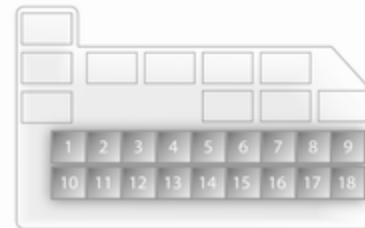

No. Circuit

- | No. | Circuit |
|-----|-------------------------------|
| 1 | Heater fan |
| 2 | Fuel injection |
| 3 | Air conditioning compressor |
| 4 | Automatic transmission |
| 5 | Brake light switch |
| 6 | ABS, ESP |
| 7 | Starter motor |
| 8 | - |
| 9 | Power steering control module |

No. Circuit

- 10 Ignition switch
- 11 Radiator fan
- 12 -
- 13 ABS, ESP
- 14 -
- 15 Engine electrics
- 16 Front fog lights
- 17 Headlight (left)
- 18 Headlight (right)

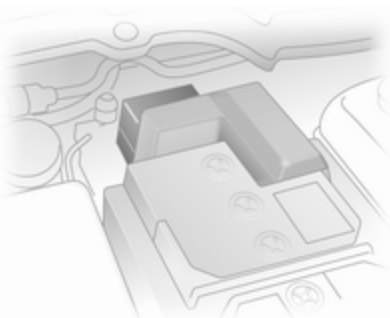
Diesel engines

The fuse box is located behind the battery in the engine compartment. Disengage the cover and lift upwards to open.

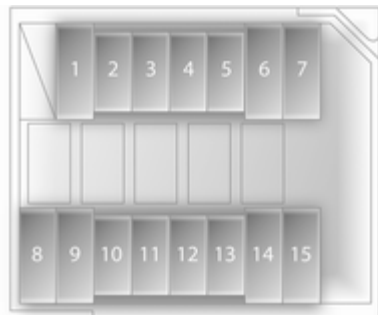
**No. Circuit**

- 1 Starter motor
- 2 Air conditioning compressor
- 3 Fuel pump
- 4 Fuel injection
- 5 Heater fan
- 6 Radiator fan
- 7 Power steering control module
- 8 ABS, ESP
- 9 ABS, ESP

No. Circuit

- 10 Brake light switch
- 11 Headlight (right)
- 12 Headlight (left)
- 13 Front fog lights
- 14 Ignition switch
- 15 Ignition switch, power windows, wipers, starter

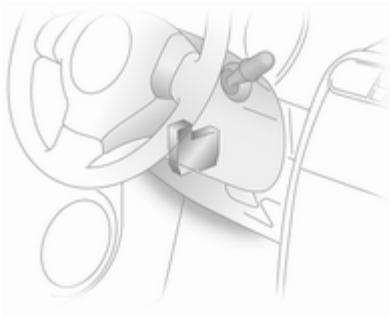
Instrument panel fuse box

Located on the left-hand side of the vehicle, below the instrument panel. To open the fuse box, push the cover at both ends and remove. Do not store any objects behind the cover.



Some circuits may be protected by several fuses.

No. Circuit

- 1 -
- 2 Ignition coils
- 3 Reversing light
- 4 Instrument cluster

No. Circuit

- 5 Power outlet, cigarette lighter, power exterior mirror
- 6 Infotainment system
- 7 Power windows
- 8 Wipers/washers
- 9 Power steering
- 10 Airbag system
- 11 ABS, ESP
- 12 Tail light
- 13 -
- 14 Door lock
- 15 Diesel engine
- 16 Starter motor
- 17 -
- 18 Heater fan
- 19 Rear fog light
- 20 Infotainment system

No. Circuit

- 21 Heated rear window
- 22 Horn, hazard warning
- 23 Manual transmission
- 24 Power windows

Vehicle tools

Tools

To access the jack, vehicle tools and tyre repair kit ↻ 111, open tailgate and pull up load compartment floor carpet using the central strap located near the tailgate latch and hang the string on the hook provided ↻ 47.

Vehicles with tyre repair kit



The tools and tyre repair kit are in a storage compartment below the floor carpet in the load compartment.

Vehicles with spare wheel

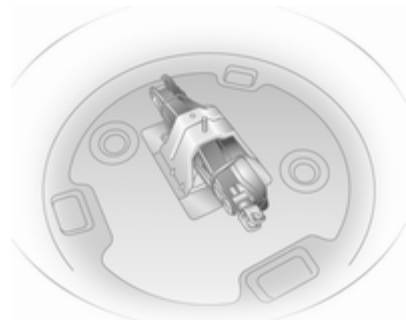

The jack and the tools are in a stowage compartment in the load compartment below the spare wheel. Spare wheel ↻ 116.

Wheels and tyres

Tyre condition, wheel condition

Drive over edges slowly and at right angles if possible. Driving over sharp edges can cause tyre and wheel damage. Do not trap tyres on the kerb when parking.

Regularly check the wheels for damage. Seek the assistance of a workshop in the event of damage or unusual wear.

Tyres

Factory-fitted tyres are matched to the chassis and offer optimum driving comfort and safety.

Winter tyres

Winter tyres improve driving safety at temperatures below 7 °C and should therefore be fitted on all wheels.

Tyres of size 165/70 R 14 and 185/60 R 15 may be used as winter tyres.

In accordance with country-specific regulations, affix the speed sticker in the driver's field of view.

Tyre designations

E.g. **185/65 R 15 88 T**

- 185** = Tyre width, mm
- 65** = Cross-section ratio (tyre height to tyre width), %
- R** = Belt type: Radial
- RF** = Type: RunFlat
- 15** = Wheel diameter, inches
- 88** = Load index e.g. 88 is equivalent to 567 kg
- T** = Speed code letter

Speed code letter:

- Q** = up to 160 km/h (100 mph)
- S** = up to 180 km/h (112 mph)
- T** = up to 190 km/h (118 mph)
- H** = up to 210 km/h (130 mph)
- V** = up to 240 km/h (150 mph)
- W** = up to 270 km/h (168 mph)

Tyre pressure

Check the pressure of cold tyres at least every 14 days and before any long journey. Do not forget the spare wheel.

Tyre pressure ⇨ 135 and the label located on the driver's door pillar.



The tyre pressure data refers to cold tyres. It applies to summer and winter tyres.

Always inflate the spare tyre to the pressure specified for full load.

The ECO tyre pressure serves to achieve the smallest amount of fuel consumption possible.

Incorrect tyre pressures will impair safety, vehicle handling, comfort and fuel economy and will increase tyre wear.

⚠ Warning

If the pressure is too low, this can result in considerable tyre warm-up and internal damage, leading to tread separation and even to tyre blow-out at high speeds.

Tread depth

Check tread depth at regular intervals.

Tyres should be replaced for safety reasons at a tread depth of 2-3 mm (4 mm for winter tyres).



The legally permissible minimum tread depth (1.6 mm) has been reached when the tread has worn down as far as one of the tread wear indicators (TWI). Their position is indicated by markings on the sidewall.

If there is more wear at the front than the rear, swap round front wheels and rear wheels. Ensure that the direction of rotation of the wheels is the same as before.

Tyres age, even if they are not used. We recommend tyre replacement every 6 years.

Changing tyre and wheel size

If tyres of a different size than those fitted at the factory are used, it may be necessary to reprogramme the speedometer and make other vehicle modifications.

⚠ Warning

Use of unsuitable tyres or wheels may lead to accidents and will invalidate the vehicle type approval.

Wheel covers

Wheel covers and tyres that are factory approved for the respective vehicle and comply with all of the relevant wheel and tyre combination requirements must be used.

If the wheel covers and tyres used are not factory approved, the tyres must not have a rim protection ridge

Wheel covers must not impair brake cooling.

⚠ Warning

Use of unsuitable tyres or wheel covers could lead to sudden pressure loss and thereby accidents.

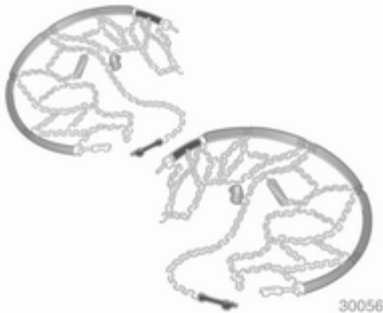
Tyre chains

Tyre chains are only permitted on the front wheels.

Always use fine mesh chains that add no more than 10 mm to the tyre tread and the inboard sides (including chain lock).

⚠ Warning

Damage may lead to tyre blowout.

The use of tyre chains is not permitted on the temporary spare wheel.

Tyre repair kit

Minor damage to the tyre tread or sidewall can be repaired with the tyre repair kit.

Do not remove foreign bodies from the tyres.

Tyre damage exceeding 4 mm or that is at tyre's sidewall near the rim cannot be repaired with the tyre repair kit.

⚠ Warning

Do not drive faster than 80 km/h (50 mph).

Do not use for a lengthy period.

Steering and handling may be affected.

If your vehicle has a flat tyre:

Apply the parking brake and engage first gear, reverse gear or **P**.



The tyre repair kit is stowed beneath the floor carpet in the load compartment



1. Shake sealant bottle, remove cap and screw filler hose on to bottle, to pierce inner cap.



2. Unscrew valve cap from defective tyre and unscrew valve insert using supplied remover.



3. Remove the plug from the end of the filler hose and insert filler hose onto tyre valve.
4. Hold the sealant bottle with bottom pointing upwards and squeeze all of the sealant into the tyre.
5. Disconnect filler hose and firmly screw insert into valve using the valve insert remover.
If necessary, use the supplied spare valve insert.

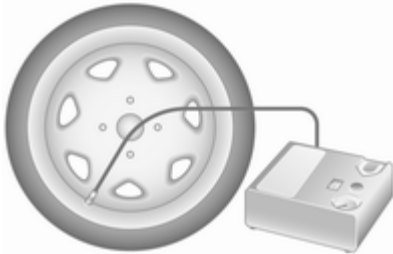

6. Place the compressor unit on level ground and unwrap the air compressor hose from the compressor unit.

Ensure the compressor on/off switch is in position **O** (off) and screw the hose on to tyre valve.

7. Unwrap electrical connection cable from the compressor unit. Insert plug into power outlet.
8. Turn ignition key to position **ACC**. To avoid discharging the battery, we recommend running the engine.



9. Switch compressor on/off switch to position **I** (on).
10. Inflate the tyre to the correct pressure \curvearrowright 135. If there is no reading, the air compressor hose to tyre valve connection may be faulty. Re-check the connection. If the prescribed tyre pressure is not obtained within 10 minutes, remove the tyre repair kit. Move the vehicle one tyre rotation. Reattach the tyre repair kit and continue the filling procedure for 10 minutes. If the prescribed tyre

pressure is still not obtained, the tyre is too badly damaged. Seek the assistance of a workshop.

If the tyre is overinflated, reduce the pressure by pressing the deflation button on the compressor.

Do not operate the compressor for more than 10 minutes, to avoid overheating.

11. When the correct tyre pressure has been reached, switch compressor on/off switch to position **O** (off).
12. Remove plug from the power outlet, detach air compressor hose from tyre valve and replace valve cap.
13. Return air compressor hose and electrical connection cable to their original locations in the compressor unit.
14. Remove any excess sealant using a cloth.

15. Take the label indicating maximum permitted speed from the kit and affix in the driver's field of view.
16. Continue driving immediately so that sealant is evenly distributed throughout the tyre. After driving approx. 5 km (3 miles) (but no more than 10 minutes), stop and check tyre pressure, using the compressor.
17. If the tyre pressure has not dropped below 130 kPa (1.3 bar / 19 psi), it may be adjusted to the prescribed value. Repeat the procedure until there is no more loss of pressure.

If the tyre pressure has dropped below 130 kPa (1.3 bar / 19 psi), the vehicle must not be driven. Seek the assistance of a workshop.
18. Stow tyre repair kit below the floor carpet in the load compartment.

Note

The driving characteristics of the repaired tyre is severely affected, therefore have this tyre replaced.

If unusual noise is heard or the compressor becomes hot, turn compressor off for at least 30 minutes.

Pay attention to storage information and best before date on sealant bottle. Its sealing capability is not guaranteed after this time.

Replace the used sealant bottle. Dispose of the bottle as prescribed by applicable laws.

Wheel changing

Some vehicles are equipped with a tyre repair kit instead of a spare wheel ⇨ 111.

Make the following preparations and observe the following information:

- Park the vehicle on a level, firm and non-slippery surface. The front wheels must be in the straight-ahead position.
- Apply the parking brake and engage first gear, reverse gear or P.
- Remove the spare wheel ⇨ 116.
- Never change more than one wheel at a time.
- Use the jack only to change wheels in case of puncture, not for seasonal winter or summer tyre change.
- If the ground on which the vehicle is standing is soft, a solid board (max. 1 cm/0.4 inches thick) should be placed under the jack.
- No people or animals may be in the vehicle when it is jacked-up.
- Never crawl under a jacked-up vehicle.
- Do not start the vehicle when it is raised on the jack.

- Before screwing in the wheel bolts, clean them and lightly coat the taper of each wheel bolt with commercially available grease.

1. Pull off the wheel cover. ⇨ 108.

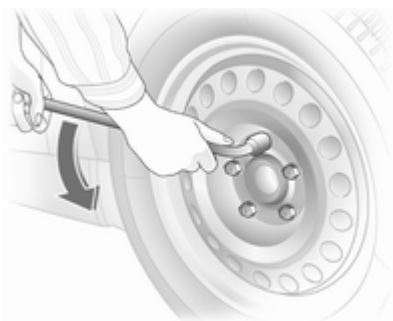

2. Install the wheel wrench ensuring that it locates securely and slacken each bolt by half a turn.

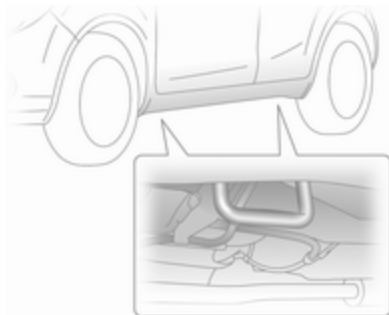

3. Ensure the jack is positioned correctly with the vehicle jacking points.

The location of front and rear jacking bars may be indicated by notches on the bottom edge of the vehicle, under the doors.



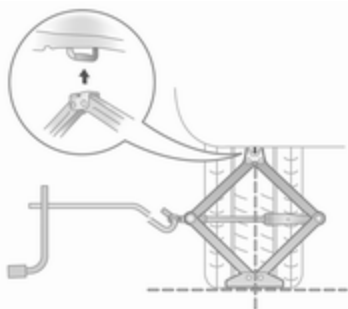

4. Attach the jack handle to the wheel bolt wrench (as shown in illustration) and insert hook end of jack handle through jack eye.

Before positioning the jack, set it to the necessary height by rotating the jack handle clockwise using the attached wheel bolt wrench.

Position jack at the front or rear jacking point located nearest to the wheel concerned so that the jack claw spans the vertical base. Make sure it is properly

positioned, ensuring the jacking bar fits securely into the jack head groove.

The jack base must be on the ground directly below the jacking point in a manner that prevents it from slipping.

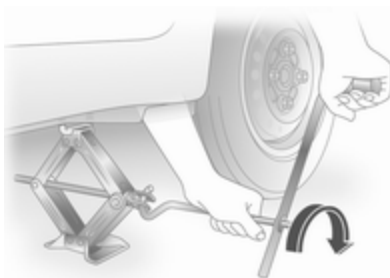

5. Rotate jack handle clockwise using the attached wheel bolt wrench to raise vehicle. Raise the vehicle until the wheel is just clear of the ground.
6. Unscrew wheel bolts completely by turning anti-clockwise and wipe clean with a cloth.

Put wheel bolts somewhere where the threads will not be soiled.

7. Change the wheel.
8. Screw in the wheel bolts.
9. Lower vehicle.
10. Install the wheel wrench ensuring that it locates securely and tighten each bolt in a crosswise sequence. Tightening torque is 85 Nm.
11. Align the valve hole in the wheel cover with the tyre valve before installing.
12. Stow the replaced wheel ↗ 116 and the vehicle tools ↗ 108.
13. Check the tyre pressure of the installed tyre and also the wheel bolt torque as soon as possible.

Have the defective tyre renewed or repaired.

Spare wheel

Some vehicles are equipped with a tyre repair kit instead of a spare wheel.

The spare wheel can be classified as a temporary spare wheel depending on the size compared to the other mounted wheels and country regulations.

The spare wheel has a steel rim.

Use of a spare wheel that is smaller than the other wheels or together with winter tyres could affect driveability. Have the defective tyre replaced as soon as possible.

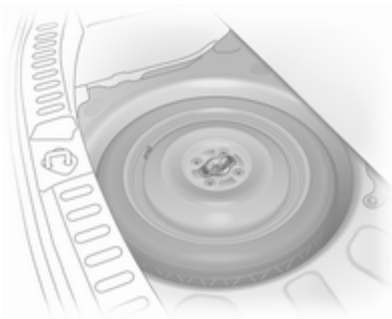

To access the spare wheel, open tailgate and pull up load compartment floor carpet using the central strap

located near the tailgate latch and hang the string on the hook provided ↗ 47.

To remove, lift spare wheel, move to a vertical position and remove from above.

Temporary spare wheel

Use of the temporary spare wheel could affect driveability. Have the defective tyre renewed or repaired as soon as possible.

Only mount one temporary spare wheel. Do not drive faster than 80 km/h (50 mph). Take curves slowly. Do not use for a long period of time.

Tyre chains ↗ 111.

Directional tyres

Fit directional tyres such that they roll in the direction of travel. The rolling direction is indicated by a symbol (e.g. an arrow) on the sidewall.

The following applies to tyres fitted opposing the rolling direction:

- Driveability may be affected. Have the defective tyre renewed or repaired as soon as possible.
- Do not drive faster than 80 km/h (50 mph).
- Drive particularly carefully on wet and snow-covered road surfaces.

Jump starting

Do not start with quick charger.

A vehicle with a discharged battery can be started using jump leads and the battery of another vehicle.

Warning

Be extremely careful when starting with jump leads. Any deviation from the following instructions can lead to injuries or damage caused by battery explosion or damage to the electrical systems of both vehicles.

- Never expose the battery to naked flames or sparks.
- A discharged battery can already freeze at a temperature of 0 °C. Defrost the frozen battery before connecting jump leads.
- Avoid contact with eyes, skin, fabrics and painted surfaces. The fluid contains sulphuric acid which can cause injuries and damage in the event of direct contact.

- Wear eye protection and protective clothing when handling a battery.
- Use a booster battery with the same voltage (12 volts). Its capacity (Ah) must not be much less than that of the discharged battery.
- Use jump leads with insulated terminals and a cross section of at least 16 mm² (25 mm² for diesel engines).
- Do not disconnect the discharged battery from the vehicle.
- Switch off all unnecessary electrical consumers.
- Do not lean over the battery during jump starting.
- Do not allow the terminals of one lead to touch those of the other lead.
- The vehicles must not come into contact with each other during the jump starting process.
- Apply the parking brake, transmission in neutral, automatic transmission in **P**.

Lead connection order:

1. Connect the red lead to the positive terminal of the booster battery.
2. Connect the other end of the red lead to the positive terminal of the discharged battery.
3. Connect the black lead to the negative terminal of the booster battery.
4. Connect the other end of the black lead to a vehicle grounding point, such as the engine block or an engine mounting bolt. Connect as far away from the discharged battery as possible.

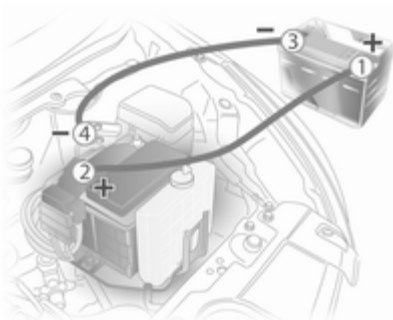

Route the leads so that they cannot catch on rotating parts in the engine compartment.

To start the engine:

1. Start the engine of the vehicle providing the jump start.
2. After 5 minutes, start the other engine. Start attempts should be made for no longer than 15 seconds at an interval of 1 minute.
3. Allow both engines to idle for approx. 3 minutes with the leads connected.

4. Switch on electrical consumers (e.g. headlights, heated rear window) of the vehicle receiving the jump start.
5. Reverse above sequence exactly when removing leads.

Towing

Towing the vehicle

Towing from the front is permissible in emergency situations only.



Disengage cap at bottom and remove downwards.

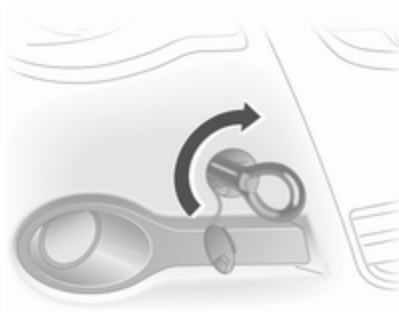

The towing eye is stowed with the vehicle tools ⇨ 108.

Screw in the towing eye as far as it will go until it stops in a horizontal position. If necessary, use jack handle to tighten.

Attach a tow rope – or better still a tow rod – to the towing eye.

The towing eye must only be used for towing and not recovering the vehicle.

Switch on ignition to release steering wheel lock and to permit operation of brake lights, horn and windscreen wipers.

Transmission in neutral.

Caution

Drive slowly. Do not drive jerkily. Excessive tractive force can damage the vehicle.

When the engine is not running, considerably more force is needed to brake and steer.

To prevent the entry of exhaust fumes from the towing vehicle, switch on the Air recirculation system and close the windows.

Vehicles with automatic transmission must be towed facing forwards, not faster than 80 km/h (50 mph) nor further than 100 km (60 miles). In all other cases and when the transmission is defective, the front axle must be raised off the ground.

Seek the assistance of a workshop.

After towing, unscrew the towing eye and refit the cover.

Towing another vehicle

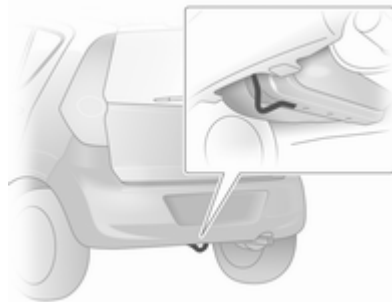

Caution

The rear lashing eye is designed for shipping purposes only. Towing another vehicle from the rear is not permitted!

Appearance care

Exterior care

Locks

The locks are lubricated at the factory using a high quality lock cylinder grease. Use de-icing agent only when absolutely necessary, as this has a degreasing effect and impairs lock function. After using de-icing agent, have the locks regreased by a workshop.

Washing

The paintwork of your vehicle is exposed to environmental influences. Wash and wax your vehicle regularly. When using automatic vehicle washes, select a programme that includes waxing.

Bird droppings, dead insects, resin, pollen and the like should be cleaned off immediately, as they contain aggressive constituents which can cause paint damage.

If using a vehicle wash, comply with the vehicle wash manufacturer's instructions. The windscreen wipers

and rear window wiper must be switched off. Remove antenna and external accessories such as roof racks etc.

If you wash your vehicle by hand, make sure that the insides of the wheel housings are also thoroughly rinsed out.

Clean edges and folds on opened doors and the bonnet as well as the areas they cover.

Do not clean the engine compartment with a steam-jet or high-pressure jet cleaner.

Thoroughly rinse and leather-off the vehicle. Rinse leather frequently. Use separate leathers for painted and glass surfaces: remnants of wax on the windows will impair vision.

Do not use hard objects to remove spots of tar. Use tar removal spray on painted surfaces.

After washing the vehicle, lubricate door hinges to prevent wear.

Exterior lights

Headlight and other light covers are made of plastic. Do not use any abrasive or caustic agents, do not use an ice scraper, and do not clean them dry.

Polishing and waxing

Wax the vehicle regularly (at the latest when water no longer beads). Otherwise, the paintwork will dry out.

Polishing is necessary only if the paint has become dull or if solid deposits have become attached to it.

Paintwork polish with silicone forms a protective film, making waxing unnecessary.

Plastic body parts must not be treated with wax or polishing agents.

Windows and windscreen wiper blades

Use a soft lint-free cloth or chamois leather together with window cleaner and insect remover.

When cleaning the rear window, make sure the heating element inside the window is not damaged.

For mechanical removal of ice, use a sharp-edged ice scraper. Press the scraper firmly against the glass so that no dirt can get under it and scratch the glass.

Clean smearing wiper blades with a soft cloth and window cleaner.

Wheels and tyres

Do not use high-pressure jet cleaners.

Clean rims with a pH-neutral wheel cleaner.

Rims are painted and can be treated with the same agents as the body.

Paintwork damage

Rectify minor paintwork damage with a touch-up pen before rust forms. Have more extensive damage or rust areas repaired by a workshop.

Underbody

Some areas of the vehicle underbody have a PVC undercoating while other critical areas have a durable protective wax coating.

After the underbody is washed, check the underbody and have it waxed if necessary.

Bitumen/rubber materials could damage the PVC coating. Have underbody work carried out by a workshop.

Before and after winter, wash the underbody and have the protective wax coating checked.

Interior care

Interior and upholstery

Only clean the vehicle interior, including the instrument panel fascia and panelling, with a dry cloth or interior cleaner.

The instrument panel should only be cleaned using a soft damp cloth.

Clean fabric upholstery with a vacuum cleaner and brush. Remove stains with an upholstery cleaner.

Clean seat belts with lukewarm water or interior cleaner.

Caution

Close Velcro fasteners as open Velcro fasteners on clothing could damage seat upholstery.

Plastic and rubber parts

Plastic and rubber parts can be cleaned with the same cleaner as used to clean the body. Use interior cleaner if necessary. Do not use any other agent. Avoid solvents and petrol in particular. Do not use high-pressure jet cleaners.

Service and maintenance

General information	123
Scheduled maintenance	124
Recommended fluids, lubricants and parts	128

General information

Service information

In order to ensure economical and safe vehicle operation and to maintain the value of your vehicle, it is of vital importance that all maintenance work is carried out at the proper intervals as specified.

Interim service

Due every 15,000 km (10,000 miles) or 1 year, whichever occurs first.

Main service

Due every 30,000 km (20,000 miles) or 2 years, whichever occurs first.

Confirmations

Confirmation of service is recorded in the Service and Warranty Booklet. The date and kilometre/mileage is completed with the stamp and signature of the servicing workshop.

Make sure that the Service and Warranty Booklet is completed correctly as continuous proof of service is essential if any warranty or

goodwill claims are to be met, and is also a benefit when selling the vehicle.

Fixed service interval

When service is due, **InSP** appears in the odometer display when the ignition is switched on. Have the next service performed by a workshop within one week or 500 km (300 miles) (whichever occurs first).

Scheduled maintenance

Service schedules

Service schedule

	by year ¹⁾	1	2	3	4	5	6
	km (x 1000) ¹⁾	15	30	45	60	75	90
Service operations	miles (x 1000) ¹⁾	10	20	30	40	50	60
Check visually control unit, lighting unit and signalling equipment as well as airbag, check steering wheel lock and ignition switch		X	X	X	X	X	X
Replace batteries for radio remote control (Do not forget the second key)					Every 2 years		
Check windscreen wipers, windscreen washer system and headlight washer system		X	X	X	X	X	X
Check coolant level, antifreeze (green), hoses ²⁾ , correct, note antifreeze concentration in the Service and Warranty Booklet		X	X	X	X	X	X
Check brake fluid level ²⁾ , correct		X		X		X	
Check battery terminals are firmly located, check battery eye		X	X	X	X	X	X
Replace pollen filter			X		X		X
● If air is badly polluted, has a high dust or sand content, or pollen, smell of the air conditioning					Agreement with customer		

1) Whichever occurs first.

2) In case of too high consumption / leakage, perform additional work with customer's agreement.

Service operations	by year ¹⁾	1	2	3	4	5	6
	km (x 1000) ¹⁾	15	30	45	60	75	90
	miles (x 1000) ¹⁾	10	20	30	40	50	60
● Visually inspect air cleaner insert - petrol engines only		X	X	X	X	X	X
Replace air cleaner insert - petrol and diesel engines				X			X
⊕ Replace spark plugs		Every 7 years / 105,000 km / 70,000 miles					
Visually inspect ribbed V-belt - petrol engines only				X			X
⊕ Replace		Every 6 years / 90,000 km / 60,000 miles					
Visually inspect ribbed V-belt and tensioner - diesel engines only			X		X		X
⊕ Replace		Every 10 years / 150,000 km / 100,000 miles					
⊕ Check valve clearance - petrol engines only			X		X		X
Change engine oil and engine oil filter		X	X	X	X	X	X
● Drain water from fuel filter, diesel		X	X	X	X	X	X
Replace and drain fuel filter, diesel			X		X		X
⊕ Check/correct, manual transmission oil level		X					
Oil change				X			X

126 Service and maintenance

Service operations	by year ¹⁾	1	2	3	4	5	6
	km (x 1000) ¹⁾	15	30	45	60	75	90
	miles (x 1000) ¹⁾	10	20	30	40	50	60
Check/adjust parking brake; visually inspect wheel mounting and suspension springs front and rear, brake lines, brake pressure hoses, fuel lines and exhaust system		X		X		X	
Check exterior of body/underbody corrosion protection and note any damage in the Service and Warranty Booklet		X	X	X	X	X	X
Visually inspect front and rear wheel brakes		X	X	X	X	X	X
●⊕ Check, correct Automatic transmission fluid level			X		X		X
Visually inspect fluid hose							X
Change fluid		Every 165,000 km / 110,000 miles					
Engine, transmission (AT, MT), inspect air-conditioning compressor for leaks ²⁾		X	X	X	X	X	X
● Remove brake drum, clean, visually check					X		
Visually inspect folding covers on steering, tie rods and axle drive				X			X
Tie rod and supporting joint checking			X		X		X
⊕ Change brake and clutch fluid		Every 2 years					
Change coolant		Every 3 years / 45,000 km / 30,000 miles					

²⁾ In case of too high consumption / leakage, perform additional work with customer's agreement.

Service operations	by year ¹⁾	1	2	3	4	5	6
	km (x 1000) ¹⁾	15	30	45	60	75	90
	miles (x 1000) ¹⁾	10	20	30	40	50	60
Undo wheel fastening and tighten to torque		X	X	X	X	X	X
Check tyre condition. Check/correct tyre pressure (including spare wheel)							
With tyre repair kit - check completeness and expiry date of kit							
Visually inspect first-aid kit, lashing eyes, warning triangle (presence in designated stowage compartment, completeness and expiry date)			X		X		X
Check/correct headlight adjustment (including auxiliary headlights)			X		X		X
Grease door hinges, door stop, lock cylinder, striker plate, bonnet lock, tailgate hinges			X		X		X
Test drive, final inspection (check steering wheel lock and ignition switch, instruments and indicator lights, entire brake system, steering, air conditioning, engine, body and running gear), reset service interval display		X	X	X	X	X	X

⊕: Additional operations.

●: Under extreme operating conditions and if required by country-specific conditions, the intervals are reduced.

Additional servicing

Additional operations ⊕

Additional operations are not required every service but can be performed in conjunction with a regular service. Time allowances for such work are not included in the scope of regular services and will be charged for additionally. It is more economic if these operations are performed as part of a scheduled service than having them performed separately.

Extreme operating conditions ●

Extreme operating conditions are given when at least one of the following occurs frequently:

- Cold starts
- Stop and go
- Trailer towing
- Gradients and/or high altitudes
- Poor road surfaces
- Sand and dust
- Extreme temperature fluctuations

Police vehicles, taxis and driving school vehicles are also classified as operating under extreme conditions.

Under extreme operating conditions, it may be necessary to have certain scheduled service work done more frequently than the scheduled intervals.

Seek technical advice on the servicing requirements dependent on the specific operating conditions.

Recommended fluids, lubricants and parts

Recommended fluids and lubricants

Only use products that have been tested and approved. Damage resulting from the use of non-approved materials will not be covered by the warranty.

Warning

Operating materials are hazardous and could be poisonous. Handle with care. Pay attention to information given on the containers.

Engine oil

Engine oil is identified by its quality and also its viscosity. Quality is more important than viscosity when selecting which engine oil to use.

Engine oil quality

GM-LL-A-025 = Petrol engines
GM-LL-B-025 = Diesel engines

GM	=	General Motors Europe
LL	=	Longlife
A or B	=	Engine oil quality specification
025	=	Validity index

Engine oil that meets classifications GM-LL-A-025 and GM-LL-B-025 is suitable for both petrol and diesel engines.

Topping up engine oil

Engine oils of different manufacturers and brands can be mixed as long as they comply with the required engine oil (quality and viscosity).

If engine oil of the required quality is not available, a maximum of 1 litre of ACEA A3/B4 or A3/B3 grade may be used (only once between each oil change). The viscosity should be of the correct rating.

Use of ACEA A1/B1 and A5/B5 engine oil is expressly forbidden, since they can cause long-term engine damage under certain operating conditions.

Engine oil additives

The use of engine oil additives could cause damage and invalidate the warranty.

Engine oil viscosity

Use only engine oil viscosities SAE 0W-30, 0W-40, 5W-30 or 5W-40.

The SAE viscosity rating defines the ability of an oil to flow. When cold, oil is more viscous than when hot.

Multigrade oil is indicated by two figures. The first figure, followed by a W, indicates low temperature viscosity and the second figure the high temperature viscosity.

Coolant and antifreeze

Use antifreeze of recommended specification.

The system is factory filled with coolant designed for frost protection down to approx. -28 °C. This concentration should be maintained all year round.

Coolant additives intended to give additional corrosion protection or seal against minor leaks can cause

function problems. Liability for consequences resulting from the use of coolant additives will be rejected.

Brake and clutch fluid

Only use DOT4 brake fluid.

Over time, brake fluid absorbs moisture which will reduce braking effectiveness. The brake fluid should therefore be replaced at the specified interval.

Brake fluid should be stored in a sealed container to avoid water absorption.

Ensure brake fluid does not become contaminated.

Transmission fluid

Use fluid meeting specification

Grade: API GL-4

Viscosity: 75W-85 or 75W-90.

Automatic transmission fluid

Use fluid meeting specification ATF3309.

Technical data

Vehicle identification 130

Vehicle data 132

Vehicle identification

Vehicle Identification Number

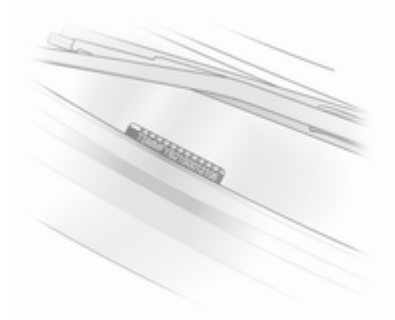

The Vehicle Identification Number is visible through the windscreen.

The VIN may also be affixed to the cowl panel in the engine compartment above the windshield washer fluid reservoir.

Identification plate

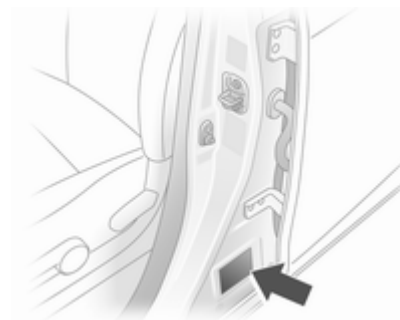

The identification plate is located on the front left door frame.



Information on identification plate:

- 1 = Manufacturer
- 2 = Vehicle Identification Number
- 3 = Permissible gross vehicle weight rating
- 4 = Permissible gross train weight
- 5 = Maximum permissible front axle load
- 6 = Maximum permissible rear axle load
- 7 = Type approval number
- 8 = Engine designation

The combined total of front and rear axle loads must not exceed the permissible gross vehicle weight. For example, if the front axle is bearing its maximum permissible load, the rear axle can only bear a load that is equal to the gross vehicle weight minus the front axle load.

The technical data is determined in accordance with European Community standards. We reserve the right to make modifications. Specifications in the vehicle documents always have priority over those given in this manual.

Vehicle data**Engine data**

Sales designation	1.0	1.2	1.3
Engine identifier code	K 10 B	K 12 B	D 13 A
Number of cylinders	3	4	4
Piston displacement [cm ³]	996	1242	1248
Engine power [kW]	48	63	55
at rpm	6000	5500	4000
Torque [Nm]	90	114	190
at rpm	4800	4400	1750
Fuel type	Petrol	Petrol	Diesel
Octane rating RON			
recommended	95	95	
possible	91	91	
Oil consumption [l/1000 km]	1.0	1.0	1.0

Performance

Engine	K 10 B	K 12 B	D 13 A
Maximum speed ¹⁾ [km/h] (mph)			
Manual transmission	160 (99)	175 (109)	165 (103)
Automatic transmission	–	170 (106)	–

Fuel consumption - CO₂-emissions

Manual transmission / automatic transmission.

Engine	K 10 B	K 12 B	D 13 A
urban [l/100 km]	5.9/–	6.9/7.8	5.5/–
extra-urban [l/100 km]	4.4/–	4.7/4.9	4.0/–
total [l/100 km]	5.0/–	5.5/5.9	4.5/–
CO ₂ [g/km]	120/–	131/142	120/–

To convert l/100 km into mpg, divide 282 by the number of litres/100km.

¹⁾ The maximum speed indicated is achievable at kerb weight (without driver) plus 200 kg payload. Optional equipment could reduce the specified maximum speed of the vehicle.

Vehicle weight

Kerb weight, basic model

Agila	Engine	Manual transmission	Automatic transmission
without/with optional equipment [kg]	K 10 B	975/1030	–
	K 12 B	990/1045	1040/1065
	D 13 A	1085/1150	–

Vehicle dimensions

Length [mm]	3740
Width without exterior mirrors [mm]	1680
Width with two exterior mirrors [mm]	1932
Height (without antenna) [mm]	1590
Length of load compartment floor [mm]	1227
Load compartment width [mm]	1004
Load compartment height [mm]	870
Wheelbase [mm]	2360
Turning circle diameter [m]	9.6

Capacities

Engine	K 10 B	K 12 B	D 13 A
Engine oil including filter [l]	3.9	3.9	3.2
between MIN and MAX [l]	1.0	1.0	1.0
Fuel tank, nominal capacity [l]	45	45	45

Tyre pressures

Engine	Tyres	Comfort with up to 3 people		ECO with up to 3 people		With full load	
		front	rear	front	rear	front	rear
		[kPa/bar] (psi)	[kPa/bar] (psi)	[kPa/bar] (psi)	[kPa/bar] (psi)	[kPa/bar] (psi)	[kPa/bar] (psi)
K 10 B, K12 B	165/70 R14	230/2.3 (33)	230/2.3 (33)	-	-	250/2.5 (36)	280/2.8 (41)
	185/60 R15	230/2.3 (33)	210/2.1 (30)	280/2.8 (41)	250/2.5 (36)	230/2.3 (33)	260/2.6 (38)
D 13 A	165/70 R14	250/2.5 (36)	230/2.3 (33)	-	-	250/2.5 (36)	280/2.8 (41)
	185/60 R15	250/2.5 (36)	210/2.1 (30)	280/2.8 (41)	250/2.5 (36)	250/2.5 (36)	260/2.6 (38)
All	T125/70 R15	420/4.2 (61)	420/4.2 (61)	-	-	420/4.2 (61)	420/4.2 (61)

Index

- A**
- Accessories and vehicle modifications 94
 - Additional servicing 128
 - Adjustable air vents 80
 - Airbag and belt tensioners 58
 - Airbag deactivation 37, 58
 - Airbag system 33
 - Air conditioning regular operation 81
 - Air conditioning system 79
 - Air intake 81
 - AM-FM radio 73
 - Antilock brake system 88
 - Antilock brake system (ABS) 60
 - Anti-theft locking system 23
 - Ashtrays 53
 - Automatic transmission 86
- B**
- Battery 99
 - Bonnet 95
 - Brake assist 89
 - Brake fluid 98
 - Brakes 88, 98
 - Brake system 59
 - Bulb replacement 100
- C**
- Capacities 135
 - Catalytic converter 85
 - CD player 75
 - Central locking system 20
 - Centre high-mounted brake light 102
 - Change engine oil 61
 - Changing tyre and wheel size ... 110
 - Charging system 59
 - Child locks 22
 - Child restraint installation locations 39
 - Child restraint systems 38
 - Cigarette lighter 53
 - Climate control 16
 - Clock..... 53
 - Control indicators..... 57
 - Control of the vehicle 82
 - Convex shape 24
 - Cupholders 44
 - Curtain airbag system 36
- D**
- Danger, Warnings and Cautions ... 3
 - Daytime running lights 66
 - Diesel fuel system bleeding 99
 - Diesel particle filter..... 61, 84
 - Door open 62
- E**
- Electric adjustment 25
 - Electronic Stability Program .. 60, 90

Electronic Stability Program fault..	60
End-of-life vehicle recovery	95
Engine compartment fuse box ...	105
Engine coolant	97
Engine coolant temperature	61
Engine data	132
Engine exhaust	84
Engine oil	96
Engine oil pressure	61
Exterior care	121
Exterior lighting	13

F

Fault	87
First aid kit	48
Fixed air vents	80
Fog light	62
Fog lights	101
Folding	25
Front airbag system	34
Front fog lights	67
Front turn signal lights	101
Fuel consumption - CO ₂ - Emissions	92, 133
Fuel for diesel engines	91
Fuel for petrol engines	91
Fuel gauge	55
Fuses	104

G

Glovebox	44
----------------	----

H

Halogen headlights	100
Hand brake.....	89
Hazard warning flashers	66
Headlight flash	65
Headlight levelling system.....	62
Headlight range adjustment	66
Headlights when driving abroad ..	66
Head restraint adjustment	8
Head restraints	28
Heated	25
Heated rear window	27
Heating	30
Heating and ventilation system ..	78
High beam	62, 65
Horn	14, 51

I

Identification plate	130
Ignition switch positions	83
Immobiliser	24, 62
Instrument panel fuse box	107
Instrument panel illumination	103
Instrument panel overview	10
Instrument panel storage.....	43
Interior care	122
Interior lights	68, 103

Interruption of power supply	87
Introduction	3, 70
Isofix child restraint systems	42

J

Jump starting	118
---------------------	-----

K

Keys	19
------------	----

L

Light switch	65
Load compartment	22, 45
Load compartment cover	46
Load compartment lighting.....	68
Loading information	48
Low fuel	62

M

Malfunction indicator light	59
Manual adjustment	24
Manual anti-dazzle	26
Manual transmission	88
Manual windows	26
Mirror adjustment	8
Mobile phones and CB radio equipment	76

N

New vehicle running-in	82
Number plate light	103

O

Odometer	54
Operation	72
Outside temperature	52
Overrun cut-off	83

P

Parking	18, 83
Performance	133
Performing work	95
Pollen filter	81
Power outlets	53
Power steering.....	60
Power windows	26
Preheating	61

R

Radio data system (RDS)	74
Radio reception	75
Radio remote control	19
Rear floor storage cover	47
Rear fog light	62
Rear fog lights	67
Rear window wiper/washer	52
Recommended fluids and lubricants	128
Refuelling	92
Reversing lights	67
Roof rack	48

S

Seat adjustment	7, 29
Seat belt	8
Seat belt reminder	58
Seat belts	31
Seat position	29
Selector lever	86
Service	81, 123
Service display	56
Service schedules.....	124
Service vehicle soon	59
Side airbag system	35
Side turn signal lights	102
Spare wheel	116
Speedometer	54
Starting off	17
Starting the engine	83
Steering wheel adjustment	9, 50
Steering wheel controls	50
Sunglasses storage	44
Sun visors	27
Symbols	4

T	
Tachometer	55
Tail lights	102
TCSS off.....	60
Theft-deterrent feature	71
Three-point seat belt	32

Tools	108
Top-tether child restraint systems	42
Towing another vehicle	120
Towing the vehicle	119
Traction Control system	90
Transmission	16, 60
Transmission display	56, 86
Tread depth	110
Trip computer	63
Trip odometer	55
Turn and lane-change signals	67
Turn signal	58
Tyre chains	111
Tyre designations	109
Tyre pressure	109
Tyre pressures	135
Tyre repair kit	111
Tyres	109

U

Using this manual	3
-------------------------	---

V

Vehicle dimensions	134
Vehicle Identification Number	130
Vehicle specific data	3
Vehicle storage.....	94
Vehicle unlocking	6
Vehicle weight	134

W

Warning chimes	63
Warning triangle	47
Washer and wiper systems	15
Washer fluid	98
Wheel changing	114
Wheel covers	110
Wheels and tyres	109
Windscreen wiper/washer	51
Winter tyres	109
Wiper blade replacement	99

