

ADAM

PRICES AND SPECIFICATIONS

2019 models. Prices effective 31 August 2018



ADAM RANGE HIGHLIGHTS / PRICES



ADAM PRICES

Trim	Engine	Transmission	CO ₂	Tax Band	Tax €	RRP €
JAM	1.4i (100PS) Start/Stop	Manual	128	A4	200	16,250

The above is for information purposes only as our products are continually updated and changes may be made to the specifications at any time. If you require any specific feature, you must consult your authorised Opel Dealer who is regularly updated with any change in specification. Specifications are subject to change without notice.

RRP does not include recommended delivery charge of €700. This price includes the recommended cost of PDI, number plates and delivery to an Opel Dealer. The recommended delivery charge does not include fuel supplied by the Dealer, Motor insurance or any other goods or services supplied by agreement between the Dealer and the customer.

Prices effective 31.8.18. Prices subject to alteration or change without notice or obligation.

JAM

Highlights

- Cruise control
- Air conditioning
- Bluetooth® audio streaming / mobile phone portal
- Three-spoke leather-covered steering wheel

Infotainment:

- CD 30 BT audio system
 - AM/FM radio
 - CD/MP3 CD player
 - Bluetooth® audio streaming
 - Bluetooth® mobile phone portal
 - USB audio connection
 - Aux-in socket
- Four speakers

Interior convenience / styling:

- Cruise control
- Air conditioning
- Leather-covered steering wheel
- Speed-sensitive power-assisted steering
- City steering mode
- Steering column adjustable for reach / rake
- Steering wheel audio / phone / cruise controls
- Driver's seat height adjuster
- Multi-function trip computer
- 50/50 split-folding rear seat back

Exterior convenience / styling:

- Electrically operated front windows
- Electrically adjustable / heated door mirrors
- Body-colour door handles
- Black B-pillars
- 16-inch Horns Silver alloy wheels

Safety / security features:

- Electronic Stability Programme (ESP)
- Anti-lock Braking System (ABS)
- Six airbags
- Hill start assist
- Seatbelt reminders for all seats
- ISOFIX child seat mounting points on rear seats
- Tyre pressure monitoring system
- Daytime running lights
- Remote control central locking
- Engine deadlock immobiliser

ADAM FEATURES / OPTIONS

SAFETY

Driver/passenger airbags

- Driver's airbag • Front passenger's airbag • Front seat side-impact airbags
- Full-size curtain airbags for front and rear seat passengers

Seating

- Height-adjustable front seat head restraints • Outer rear seat head restraints
- Anti-submarining ramps in front seats – Helps prevent occupants sliding underneath the lap belt during a collision.

Seatbelts

- Height-adjustable front seatbelts • Four inertia-reel lap and diagonal seatbelts • Front seatbelt pretensioner system – Pretensioners tighten the seatbelt in the event of an accident limiting forward movement. • Front seatbelt force limiters – Reduces potential upper body injuries during a frontal impact. • Front and rear 'seatbelt unfastened' warning light

Child safety

- Deactivation switch for front passenger's front and side-impact airbags – Permits the safe use of a child seat in the front passenger seat. • ISOFIX child seat mountings incorporating top tether anchor points located on rear seats (does not include child seat) – Allows ISOFIX child safety seats to be securely fixed into the car. The ISOFIX mounting system reduces forward movement in an accident and makes the child seat easier to install.

Driver/passenger safety

- Energy-absorbing steering column • Pedal release system – Reduces potential injury to the driver's legs and feet during a severe frontal impact. • Laminated windscreen • Side-impact protection beams • Reinforced passenger safety cell • Deformation zones front and rear

Pedestrian safety

- Bonnet/headlight/wiper structure – Designed to reduce pedestrian head and upper body injuries.
- Upper and lower bumper design – Reduces upper and lower leg injuries.

Stability

Electronic Stability Programme (ESP):

– Works in conjunction with the vehicle's electronic braking and engine systems to keep the car stable in many different situations. ESP monitors many different inputs to determine when the car starts to lose traction, it can then immediately respond by varying the brake pressure between up to three wheels and adjust the engine output to help correct the loss of traction and improve stability.

Additional ESP features:

- Traction control • Cornering brake control • Straight line stability control

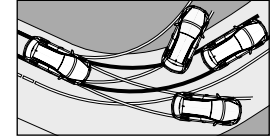

Braking

Anti-lock Braking System (ABS):

– Prevents the vehicle's wheels from locking up under heavy braking by momentarily reducing brake pressure at the appropriate wheel, ensuring that you can maintain control of the steering.

Additional braking features:

– The same electronic systems used in the ABS and ESP also deliver exceptional braking performance.

- Emergency brake assist – When emergency braking is detected the vehicle automatically applies the maximum possible braking assistance.
- Electronic brakeforce distribution – Automatically apportions the optimum braking force to each wheel. • Adaptive brake lights – Automatically warns other road users of heavy braking. • Hill start assist – Briefly maintains rear brake pressure to stop the vehicle rolling back on an incline. • Hazard warning lights

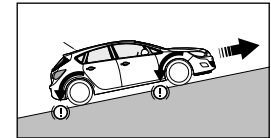

Tyre pressure

- Tyre pressure monitoring system

SECURITY

Standard security features

- 'Key left in ignition' audible warning • Electronically protected audio equipment • Engine deadlock immobiliser
- Visible Vehicle Identification Number (VIN) • Locking wheel bolts for alloy wheels



Central locking

- Remote control • Operates on doors, tailgate and fuel filler flap • Deadlocking • Central locking activation switch on fascia
- One folding key/one static key each with integral remote control function (folding key is colour-keyed to body colour)

Prices effective as of 31.8.18. Prices are subject to alteration without notice or obligation. ● = Standard equipment. ○ = Optional at extra cost.

	JAM	Prices including taxes (€)
Standard security features	●	
Central locking	●	

ADAM FEATURES / OPTIONS

DRIVER ASSISTANCE	JAM	Prices including taxes (€)
Cruise control with speed limiter <ul style="list-style-type: none"> Cruise control feature – enables you to maintain a constant speed – making it ideal for economical motorway driving. Speed limiter function – can be set to ensure that you do not exceed the speed limit and can be easily overridden if required. Steering wheel mounted controls 	●	
Parking sensors <ul style="list-style-type: none"> Rear parking distance sensors – audible warning. 	 Easier parking	350
Technical Pack <ul style="list-style-type: none"> Rear parking distance sensors R4.0 IntelliLink touchscreen infotainment system – See infotainment section for details. 	 Parking / audio upgrade	750
Steering <ul style="list-style-type: none"> Speed-sensitive electric power-assisted steering City mode button – Provides lighter steering at parking speeds. 	●	
DRIVER INFORMATION		
Instrumentation <ul style="list-style-type: none"> Black instruments with chrome edging Speedometer Rev counter Fuel gauge with low fuel level warning light Water temperature gauge Instrument panel light dimmer Shift-up indication light (Start/Stop models) – Indicates when to change gear for optimum fuel economy. 	●	
Driver information display (centrally located in instrument cluster) <ul style="list-style-type: none"> Displays trip computer data Total mileage Service-due indicator Tyre pressure monitoring system Handbrake-on / low brake fluid level warning lights 	●	
Central fascia display <ul style="list-style-type: none"> Audio information Digital clock with automatic RDS time adjustment Outside air temperature with ice warning function Additional features dependent on infotainment unit – See infotainment section for details. 	●	
Multi-function trip computer (displayed on driver information display) <ul style="list-style-type: none"> Trip mileage Vehicle range based on remaining fuel Average fuel economy Instantaneous fuel economy 	●	
HEATING AND VENTILATION		
Air conditioning <ul style="list-style-type: none"> Air recirculation facility Cabin particulate filter – Removes dust, airborne particles and pollen. Four-speed fan Illuminated controls 	●	
Winter Pack <ul style="list-style-type: none"> Heated leather-covered steering wheel Heated front seats 	 Warm welcome	350
Additional features <ul style="list-style-type: none"> Four adjustable fascia vents Windscreen demist vents Side window demist vents Heated rear screen with timed cut-off 	●	

Prices effective as of 31.8.18. Prices are subject to alteration without notice or obligation. ● = Standard equipment. ○ = Optional at extra cost.

ADAM FEATURES / OPTIONS

INFOTAINMENT	JAM	Prices including taxes (€)
<p>CD 30 BT Radio/CD player with Bluetooth® Onboard features: • CD/MP3 CD player • AM/FM stereo radio with 36 station presets • RDS with Traffic Programme Media connections: • USB connection with iPod control • Bluetooth® A2DP audio streaming (Advanced Audio Distribution Profile) • Aux-in socket Mobile phone portal: • Bluetooth® connectivity • Handsfree calls • Vehicle microphone • Phone book access – <i>Features dependent on mobile phone.</i></p>	●	
<p>R4.0 IntelliLink touchscreen infotainment system Onboard features: 7-inch colour touchscreen • AM/FM stereo radio with 36 station presets • RDS with Traffic Programme Media connections: • USB connection with iPod control • Bluetooth® A2DP audio streaming (Advanced Audio Distribution Profile) Mobile phone portal: • Bluetooth® connectivity • Handsfree calls via steering wheel controls • Vehicle microphone • Phone book access – <i>Contacts/last calls/missed calls etc. are mirrored on IntelliLink's display and are easily navigated using the touchscreen (features dependent on mobile phone).</i> Smartphone projection: • Apple CarPlay™ • Android Auto™ – <i>Smartphone projection allows operation via voice command / touchscreen / buttons to control apps / music playback.</i> Gallery (Only available when the vehicle is stationary): • Photo gallery with slide show feature • Video playback with soundtrack played through car speakers Please note: Only available as part of optional Technical Pack.</p>	☐	See Technical Pack
<p>Navi 4.0 IntelliLink touchscreen navigation and infotainment system Onboard features: • 7-inch colour touchscreen • AM/FM stereo radio with 36 station presets • RDS with Traffic Programme Navigation features: • Satellite navigation system 2D street level mapping • European coverage • Points-of-interest search • Eco routing • Map updates via USB Media connections: • USB connection with iPod control • Bluetooth® A2DP audio streaming (Advanced Audio Distribution Profile) Mobile phone portal: • Bluetooth® connectivity • Handsfree calls via steering wheel controls • Vehicle microphone • Phone book access – <i>Contacts/last calls/missed calls etc. are mirrored on IntelliLink's display and are easily navigated using the touchscreen (features dependent on mobile phone).</i> Smartphone projection: • Apple CarPlay™ • Android Auto™ – <i>Smartphone projection allows operations via voice command / touchscreen / buttons to control apps / music playback.</i> Gallery (Only available when the vehicle is stationary): • Photo gallery with slide show feature • Video playback with soundtrack played through car speakers</p>	○	850
<p>Standard features • Four audio speakers (upgraded to six with optional parking sensors) • Steering wheel mounted audio controls</p>	●	
<p>OnStar • Emergency and crash response • Wi-Fi hotspot • Smartphone vehicle diagnostics app • Roadside Assistance call out Please note: Includes 12 months of OnStar services (excluding Wi-Fi data charges) from date of first registration. Destination download feature only operates on models fitted with Navi 4.0 satellite navigation system. Roadside Assistance call out is subject to your vehicle being within its Opel Roadside Assistance cover period. If your car is out of Opel Roadside Assistance coverage or Policy Terms, the AA may charge for their time.</p>	○	500

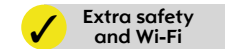





Prices effective as of 31.8.18. Prices are subject to alteration without notice or obligation. ● = Standard equipment. ○ = Optional at extra cost. ☐ = Available as part of an extra-cost option pack. All OnStar services and Wi-Fi services will cease to be available on 31 December 2020. No trial or paid subscriptions or services, including emergency response services, will be available after that date.

ADAM FEATURES / OPTIONS

SEATING AND COMFORT	JAM	Prices including taxes (€)
Steering wheel <ul style="list-style-type: none"> • Three-spoke design • Leather-covered • Satin chrome-effect bezel • Reach and rake adjustable • Audio / phone / cruise controls 	●	
Front seats Driver's seat (eight-way adjustable): • Height (up/down) • Reach (fore/aft) • Backrest (upright/recline) • Head restraint (up/down) Front passenger's seat (six-way adjustable): • Reach (fore/aft) • Backrest (upright/recline) • Head restraint (up/down) • Easy-tilt front seats with memory function	●	
Rear seats <ul style="list-style-type: none"> • Two-person layout • 50/50 split-folding rear seat back • Removable head restraints • ISOFIX child seat mountings incorporating top tether anchor points located on rear seats (does not include child seat) – <i>Allows ISOFIX child safety seats to be securely fixed into the car. The ISOFIX mounting system reduces forward movement in an accident and makes the child seat easier to install.</i> 	●	
INTERIOR STYLING		
JAM interior décor Steering wheel: • Three-spoke design • Leather-covered • Satin chrome-effect bezel Facia and door panels: <ul style="list-style-type: none"> • Exterior body colour facia/door inserts: Red 'n' Roll • Pearl White facia/door inserts: Saturday White Fever / Shades of Grey / Heavy Metal • Japan Black facia/door inserts: Black Jack / Orange Alert / Pump up the Blue / The Green Gatsby • Black door panels with black Atlantis cloth inserts • Chrome-effect interior door handles Seat trim: • Imix black fabric seat trim inserts • Plain black fabric side bolsters and surrounds	●	
INTERIOR CONVENIENCE		
Convenience features <ul style="list-style-type: none"> • Front 12-volt electrical accessory socket • Driver's and front passengers sunvisors • Driver's vanity mirror with cover • Dipping rear-view mirror • Driver's and front passenger's tiltable assist handles • Central front courtesy light • Fade up/fade down • Front map reading lights 	●	
Interior storage <ul style="list-style-type: none"> • Storage box on driver's side lower facia • Glovebox with lid • Front door pockets • Two drinks holders in rear of centre console • Rear stowage compartments in side panel 	●	
Luggage area <ul style="list-style-type: none"> • Luggage compartment cover • Illuminated • Carpeted • Interior tailgate handle • Load restraint lashing eyes • Twin gas-assisted tailgate struts 	●	









Prices effective as of 31.8.18. Prices are subject to alteration without notice or obligation. ● = Standard equipment. ○ = Optional at extra cost.

ADAM FEATURES / OPTIONS

EXTERIOR LIGHTING	JAM	Prices including taxes (€)
Standard lighting features <ul style="list-style-type: none"> Daytime running lights Halogen headlights Welcome lighting Lights-on audible warning Electric headlight beam levelling High-level LED centre rear brake light Rear fog light 	●	
Exterior Light Pack <ul style="list-style-type: none"> LED daytime running lights LED tail lights 	 LED lights	○ 300
Sight and Light Pack One <ul style="list-style-type: none"> Rain-sensitive windscreen wipers Automatic lighting control with tunnel detection Automatically dimming anti-dazzle rear-view mirror 	 Extra convenience	○ 250
EXTERIOR CONVENIENCE		
Windscreen wipers <ul style="list-style-type: none"> Two-speed windscreen wipers with variable intermittent wipe Intermittent rear window wash/wipe 	●	
Windows <ul style="list-style-type: none"> Electrically operated front windows with safety autoreverse and one-touch facility Tinted windows Heated rear window with automatic timed cut-off 	●	
Door mirrors <ul style="list-style-type: none"> Electrically adjustable/heated door mirrors (wide-angle on driver's side), manually foldable 	●	
EXTERIOR STYLING		
Body styling <ul style="list-style-type: none"> Chrome-effect front grille bar Body-colour roof and door mirrors Body-colour door handles Black B-pillars 	●	
Style Pack – Black Roof <ul style="list-style-type: none"> Black Jack roof colour and door mirrors Dark-tinted rear windows 17-inch Swiss Blade Silver alloy wheels Sports suspension 	 Black Roof Style Pack	○ 700
Style Pack – White Roof <ul style="list-style-type: none"> White my Fire roof colour and door mirrors Dark-tinted rear windows 17-inch Swiss Blade Silver alloy wheels Sports suspension 	 White Roof Style Pack	○ 700
Urban Pack <ul style="list-style-type: none"> Chrome-effect upper side window mouldings Chrome-effect door sill covers Chrome-effect inserts on exterior door handles LED daytime running lights and tail lights Multi-colour illumination (eight colours) of centre console, door trim and footwells Twin sunvisors incorporating illuminated driver's and front passenger's vanity mirrors with covers 	 Urban Pack	○ 500
Windows <ul style="list-style-type: none"> Tinted windows 	●	

Prices effective as of 31.8.18. Prices are subject to alteration without notice or obligation. ● = Standard equipment. ○ = Optional at extra cost.

ADAM FEATURES / OPTIONS



EXTERIOR COLOURS		JAM	Prices including taxes (€)
	Orange Alert <ul style="list-style-type: none"> • Solid paint • Facia/door panel inserts: Japan Black 	●	
	Red 'n' Roll <ul style="list-style-type: none"> • Brilliant paint • Facia/door panel inserts: Red 'n' Roll 	○	155
	Saturday White Fever <ul style="list-style-type: none"> • Brilliant paint • Facia/door panel inserts: Pearl White 	○	
	Black Jack <ul style="list-style-type: none"> • Two-coat metallic paint • Facia/door panel inserts: Japan Black 	○	
	Shades of Grey <ul style="list-style-type: none"> • Two-coat metallic paint • Facia/door panel inserts: Pearl White 	○	600
	Heavy Metal <ul style="list-style-type: none"> • Two-coat metallic paint • Facia/door panel inserts: Pearl White 	○	
	The Great Gatsby <ul style="list-style-type: none"> • Two-coat metallic paint • Facia/door panel inserts: Japan Black 	○	
	Pump up the Blue <ul style="list-style-type: none"> • Two-coat premium paint • Facia/door panel inserts: Japan Black 	○	750

Prices effective as of 31.8.18. Prices are subject to alteration without notice or obligation. ● = Standard equipment. ○ = Optional at extra cost.

The colours reproduced may vary slightly from the actual paint colour. As a result they should be used as a guide only. Your Opel Dealer has a comprehensive display of our paint samples.

ADAM FEATURES / OPTIONS

WHEELS AND TYRES



		JAM	Prices including taxes (€)
Reduced-size 16-inch steel spare wheel • 115/70 R 16 tyre (speed-limited to 80km/h) • Fitted in lieu of emergency tyre inflation kit Please note: Extra caution is required when driving on a reduced-size spare wheel. The original wheel and repaired / new tyre should be refitted at the earliest opportunity.		○	150
	16-inch Horns Silver alloy wheels • 195/55 R 16 tyres • Emergency tyre inflation kit (in lieu of spare wheel)	●	
	17-inch Swiss Blade Silver alloy wheels • 215/45 R 17 tyres • Emergency tyre inflation kit (in lieu of spare wheel) Please note: Only available as part of optional Style Packs.	□	See Style Packs

MECHANICAL

Standard features • Front-wheel drive • Five-speed transmission • Gas-pressure dampers • Front anti-roll bar • Speed-sensitive electric power-assisted steering	●
---	---

Prices effective as of 31.8.18. Prices are subject to alteration without notice or obligation. ● = Standard equipment. ○ = Optional at extra cost. □ = Available as part of an extra-cost option pack.

TYRE RATING

Tyre size	Fuel efficiency group	Wet grip performance	External noise	
			Measured (dB)	Group
195/55 R 16	B-C	B	71	
215/45 R 17	C	B	71	

Tyre rating according to EU Regulation 1222/2009

TRANSMISSION

- Five-speed manual gearbox

STEERING

- Speed-sensitive power-assisted steering

SUSPENSION

Front: Independent. MacPherson struts with gas-pressure dampers and coil springs. Anti-roll bar.
Rear: Compound crank with coil springs and gas-pressure dampers.

BRAKING AND STABILITY

- Electronic Stability Programme
 - Cornering brake control
 - Straight line stability control
 - Anti-lock Braking System (ABS)
 - Electronic brakeforce distribution
 - Emergency brake assist
 - Dual circuit, diagonally split braking system
- Front ventilated discs: 257mm diameter
 Rear drums: 228mm diameter

FUEL TANK CAPACITY

- 38 litres (8.4 gallons)

ADAM SPECIFICATIONS

PETROL ENGINES

1.4i (100PS)	
Capacity	1398cc
Maximum power	100PS (74kW) @ 6000rpm
Maximum torque	130Nm (96 lb.ft.) @ 4000rpm
Configuration	4 cylinders, 4 valves per cylinder, double overhead camshafts
Fuel/induction system	Naturally aspirated. Variable Valve Timing. Multi-point sequential fuel injection
Emission compliance	Euro 6d-TEMP (6.2)
Service interval	30,000km or 1 year (whichever occurs sooner)

PERFORMANCE, FUEL ECONOMY AND EMISSIONS

	Wheel size (inches)	Performance (manufacturer's figures)		Urban driving	Fuel economy litres/100km [#]		CO ₂ emissions g/km [#]
		Maximum speed (km/h)	Acceleration 0-100km/h (sec)		Extra-urban driving	Combined figure	
Manual							
1.4i (100PS) Start/Stop	16	185	11.5	6.9	4.7	5.5	128
1.4i (100PS) Start/Stop	17	185	11.5	7.5	4.9	5.8	134

= Fuel consumption data and CO₂ emission data are determined using the Worldwide harmonized Light vehicles Test Procedure (WLTP), and the relevant values are translated back to allow the comparability into NEDC, according to regulations R (EC) No. 715/2007, R (EU) No. 2017/1153 and R (EU) No. 2017/1151. The values do not take into account in particular use and driving conditions, equipment or options and may vary depending on the format of tyres. For more information on WLTP please see <https://www.opel.ie/WLTP>

EXTERIOR DIMENSIONS millimetres (inches)

ADAM

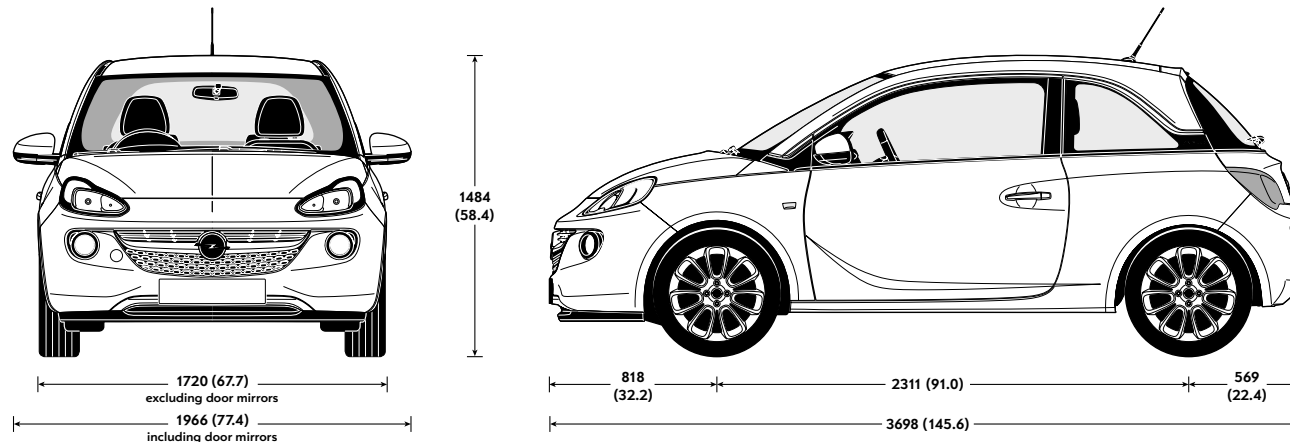

LOADSPACE DIMENSIONS mm (inches)

Maximum length (behind rear seats)	462 (18.2)
Maximum length (rear seats folded)	1041 (41.0)
Maximum width	963 (37.9)
Width between wheel arches	954 (37.6)
Maximum height	874 (34.4)

LOADSPACE CAPACITIES litres (cu. ft)

Rear seats up (under luggage compartment cover)	170 (6.0)
Rear seats folded (to upper edge of front seat back)	484 (17.1)
Rear seats folded (to roof)	663 (23.4)

* = Measured using the ECIE method.

GROSS VEHICLE WEIGHT kg

1.4i (100PS)	1480
--------------	------

Gross vehicle weight is the total permissible weight of the vehicle including passengers and luggage. The maximum roof rack loading should not exceed 50kg.