

ASTRA

PRICES AND SPECIFICATIONS

2019 models. Prices effective 21 November 2018



ASTRA RANGE HIGHLIGHTS



ASTRA SC

Highlights

- IntelliLink smartphone connectivity
- Bluetooth® audio / mobile phone
- DAB digital radio
- Air conditioning
- Cruise control with speed limiter
- Multi-function trip computer

Infotainment:

- Radio 4.0 IntelliLink
 - 7-inch colour touchscreen with DAB/FM/AM Radio
 - Smartphone connectivity for your phone, messaging, music, maps and apps
 - Apple CarPlay™ and Google Android Auto™ app projection
 - Steering wheel controls for phone, music and cruise control
 - Bluetooth® phone, messaging and music streaming
 - USB connection
 - Four speakers

Interior convenience / styling:

- Steering column adjustable for reach / rake
- Steering wheel audio / cruise controls
- Electrically operated front and rear windows

Exterior convenience / styling:

- Electrically adjustable/heated door mirrors
- Remote control central locking
- 16-inch structure wheels

Safety / security:

- Electronic Stability Programme (ESP)
- Anti-lock Braking System (ABS)
- Hill start assist
- Six airbags
- ISOFIX child seat mounting points for outer rear seats
- Tyre pressure monitoring system with individual read-out



ASTRA 120 YEARS EDITION

Highlights

- IntelliLink smartphone connectivity
- Bluetooth® audio / mobile phone
- DAB digital radio
- Air conditioning
- Cruise control with speed limiter
- Multi-function trip computer

Infotainment:

- Radio 4.0 IntelliLink
 - 7-inch colour touchscreen with DAB/FM/AM Radio
 - Smartphone connectivity for your phone, messaging, music, maps and apps
 - Apple CarPlay™ and Google Android Auto™ app projection
 - Steering wheel controls for phone, music and cruise control
 - Bluetooth® phone, messaging and music streaming
 - USB connection
 - Four speakers

Interior convenience / styling:

- As Astra SC, plus:
 - ‘Opel’ door sill covers
 - 120 year front floor mats
 - Allure black cloth seat trim

Exterior convenience / styling:

- As Astra SC, plus:
 - 16-inch alloy wheels

Safety / security:

As Astra SC.



ASTRA SRI

Highlights

- Satellite navigation
- Smartphone projection
- Forward collision alert
- Traffic sign recognition
- Lane departure warning / lane assist

Infotainment:

- Navi 900 IntelliLink
 - DAB/FM/AM Radio
 - 8-inch colour touchscreen
 - Satellite navigation
 - Smartphone connectivity for your phone, messaging, music, maps and apps
 - Apple CarPlay™ and Google Android Auto™ app projection
 - Siri / Google Now voice command for phone, messaging, music, maps and calendar
 - Steering wheel controls for phone, music and cruise control
 - Bluetooth® phone, messaging and music streaming
 - USB connection
 - Six speakers

Interior convenience / styling:

- As Astra SC, plus:
 - Leather-covered steering wheel
 - Sports-style front seats
 - Driver’s ergonomic active seat
 - Adjustable front armrest

Exterior convenience / styling:

- As Astra SC, plus:
 - Automatic lighting / wipers
 - Automatic anti-dazzle rear-view mirror
 - Front fog lights
 - 17-inch 5 twin-spoke alloy wheels

Safety / security:

- As Astra SC, plus:
 - Driver Assistance Pack One
 - Forward collision alert
 - Traffic sign recognition
 - Follow distance indicator
 - Lane departure warning / lane assist

Images for illustrative purposes. Actual specification listed above.

ASTRA RANGE HIGHLIGHTS



ASTRA ELITE

Highlights

- Satellite navigation
- Leather seat trim
- Electronic dual-zone climate control

Infotainment:

- Navi 900 IntelliLink
 - DAB/FM/AM Radio
 - 8-inch colour touchscreen
 - Satellite navigation
 - Smartphone connectivity for your phone, messaging, music, maps and apps
 - Apple CarPlay™ and Google Android Auto™ app projection
 - Steering wheel controls for phone, music and cruise control
 - Bluetooth® phone, messaging and music streaming
 - USB connection
 - Six speakers

Interior convenience / styling:

As Astra SC, plus:

- Leather seat trim
- Heated front and outer rear seats
- Heated leather-covered steering wheel
- Sports-style front seats
- Four-way electrical lumbar adjustment
- Adjustable front armrest
- Electric parking brake
- Two rear USB charging points

Exterior convenience / styling:

As Astra SC, plus:

- Automatic lighting / wipers
- Front fog lights
- 17-inch multispoke alloy wheels



ASTRA ULTIMATE (Hatchback models only)

Highlights

- Satellite navigation
- LED matrix headlights
- Leather seat trim
- Advanced Park Assist with rear view camera
- Forward collision alert

Infotainment:

As Astra Elite.

Interior convenience / styling:

As Astra Elite, plus:

- Perforated leather seat trim
- Ergonomic active front seats
- Sports-style front seats

Exterior convenience / styling:

- Parking Assist Pack
 - Advance park assist
 - Side blind spot alert
 - Rear-view camera
 - Front and rear parking distance sensors
- IntelliLux LED Matrix headlights
- LED tail lights
- Dark-tinted rear windows
- 18-inch bi-colour alloy wheels

Safety / security:

As Astra Elite, plus:

- Driver Assistance Pack One
 - Forward collision alert
 - Traffic sign recognition
 - Follow distance indicator
 - Lane departure warning / lane assist

ASTRA 5-DOOR HATCHBACK PRICES

Trim	Engine	Transmission	CO ₂	Tax Band	Tax €	RRP €
DIESEL ENGINES						
SC	1.6CDTi (110PS) Start/Stop ecoTEC	Manual	107	A3	190	24,945
SC	1.6CDTi (136PS) Start/Stop	Manual	116	A4	200	25,695
SC	1.6CDTi (136PS)	Automatic	122	B1	270	28,695
120 Years Edition	1.6CDTi (110PS) Start/Stop ecoTEC	Manual	107	A3	190	25,645
120 Years Edition	1.6CDTi (136PS) Start/Stop	Manual	116	A4	200	26,395
120 Years Edition	1.6CDTi (136PS)	Automatic	122	B1	270	29,395
SRi	1.6CDTi (110PS) Start/Stop ecoTEC	Manual	110	A3	190	27,445
SRi	1.6CDTi (136PS) Start/Stop	Manual	118	A4	200	28,195
SRi	1.6CDTi (136PS)	Automatic	126	B1	270	31,195
Elite	1.6CDTi (110PS) Start/Stop ecoTEC	Manual	110	A3	190	28,445
Elite	1.6CDTi (136PS) Start/Stop	Manual	118	A4	200	29,195
Elite	1.6CDTi (136PS)	Automatic	126	B1	270	32,195
PETROL ENGINES						
SC	1.0i Turbo (105PS) Start/Stop ecoTEC	Manual	107	A3	190	23,195
120 Years Edition	1.0i Turbo (105PS) Start/Stop ecoTEC	Manual	107	A3	190	23,895
SRi	1.0i Turbo (105PS) Start/Stop ecoTEC	Manual	110	A3	190	25,495
SRi	1.4i Turbo (150PS)	Manual	136	B2	280	26,645
Elite	1.0i Turbo (105PS) Start/Stop ecoTEC	Manual	110	A3	190	26,495
Elite	1.4i Turbo (150PS)	Manual	136	B2	280	27,645
Ultimate	1.4i Turbo (150PS)	Manual	138	B2	280	30,945

The above is for information purposes only as our products are continually updated and changes may be made to the specifications at any time. If you require any specific feature, you must consult your authorised Opel dealer who is regularly updated with any change in specification. Specifications are subject to change without notice.

RRP does not include recommended delivery charge of €700. This price includes the recommended cost of PDI, number plates and delivery to an Opel Dealer. The recommended delivery charge does not include fuel supplied by the dealer, Motor insurance or any other goods or services supplied by agreement between the Dealer and the customer.

Prices effective 21.11.18. Prices subject to alteration or change without notice or obligation.

ASTRA SPORTS TOURER PRICES

Trim	Engine	Transmission	CO ₂	Tax Band	Tax €	RRP €
DIESEL ENGINES						
SC	1.6CDTi (110PS) Start/Stop ecoTEC	Manual	112	A4	200	26,145
SC	1.6CDTi (136PS) Start/Stop	Manual	118	A4	200	26,895
120 Years Edition	1.6CDTi (110PS) Start/Stop ecoTEC	Manual	107	A3	190	26,845
120 Years Edition	1.6CDTi (136PS) Start/Stop	Manual	116	A4	200	27,595
SRi	1.6CDTi (136PS) Start/Stop	Manual	121	B1	270	29,395
SRi	1.6CDTi (136PS)	Automatic	130	B1	270	32,395
Elite	1.6CDTi (110PS) Start/Stop ecoTEC	Manual	116	A4	200	29,645
Elite	1.6CDTi (136PS) Start/Stop	Manual	121	B1	270	30,395
Elite	1.6CDTi (136PS)	Automatic	130	B1	270	33,395
PETROL ENGINES						
SRi	1.4i Turbo (150PS)	Manual	139	B2	280	27,845
Elite	1.4i Turbo (150PS)	Manual	139	B2	280	28,845

The above is for information purposes only as our products are continually updated and changes may be made to the specifications at any time. If you require any specific feature, you must consult your authorised Opel dealer who is regularly updated with any change in specification. Specifications are subject to change without notice.

RRP does not include recommended delivery charge of €700. This price includes the recommended cost of PDI, number plates and delivery to an Opel Dealer. The recommended delivery charge does not include fuel supplied by the dealer, Motor insurance or any other goods or services supplied by agreement between the Dealer and the customer.

Prices effective 21.11.18. Prices subject to alteration or change without notice or obligation.

ASTRA FEATURES / OPTIONS

SAFETY

Driver / passenger airbags

- Driver's airbag • Front passenger's airbag • Two front seat side-impact airbags
- Full-size curtain airbags for driver and front and outer rear seat passengers

Seating

- Height-adjustable front seat head restraints • Three height adjustable rear seat head restraints
- Anti-submarining ramps in all seats – Prevents occupants sliding underneath the lap belt during a collision

Seatbelts

- Height adjustable front inertia-reel lap and diagonal seatbelts • Three inertia-reel lap and diagonal rear seatbelts • Front seatbelts with crash locking tongues • Outer rear seatbelt pretensioner system – Pretensioners tighten the seatbelt in the event of an accident limiting forward movement • **Front and outer rear seatbelt force limiters** – Reduces potential upper body injuries during a frontal impact • Front and rear 'seatbelt unfastened' audible warning and warning light

Child safety

- **Deactivation switch for front passenger's airbag** – Permits the safe use of a child seat in the front passenger seat • ISOFIX child seat mountings incorporating top tether anchor points located on outer rear seats (does not include child seat) – Allows ISOFIX child safety seats to be securely fixed into the car. The ISOFIX mounting system reduces forward movement in an accident and makes the child seat easier to install • Child-proof locks on rear doors

Driver / passenger safety

- Energy-absorbing steering column • Pedal release system – Reduces potential injury to the driver's legs and feet during a severe frontal impact • Laminated windscreen • Side-impact protection beams • Reinforced passenger safety cell • Deformation zones front and rear
- Burst-proof door locks and anti-jam door design

Pedestrian safety

- Bonnet / headlight / wiper structure – Designed to reduce pedestrian head and upper body injuries
- Upper and lower bumper design – Reduces upper and lower leg injuries

Stability

Electronic Stability Programme (ESP):

– Works in conjunction with the vehicle's electronic braking and engine systems to keep the car stable in many different situations. ESP monitors many different inputs to determine when the car starts to lose traction, it can then immediately respond by varying the brake pressure between up to three wheels and adjust the engine output to help correct the loss of traction and improve stability.

Additional ESP features:

- Traction control • Cornering brake control • Straight line stability control • Rollover mitigation • Drag torque control – Maintain stability on slippery roads when lifting off the accelerator or changing gear

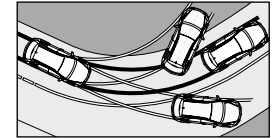

Braking

Anti-lock Braking System (ABS):

– Prevents the vehicle's wheels from locking up under heavy braking by momentarily reducing brake pressure at the appropriate wheel, ensuring that you can maintain control of the steering

Additional braking features:



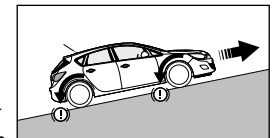



- The same electronic systems used in the ABS and ESP also deliver exceptional braking performance.
- Emergency brake assist – When emergency braking is detected the vehicle automatically applies the maximum possible braking assistance • Hazard warning lights
- Fading brake support – Compensates for the effects of brake fade
- Electronic brakeforce distribution – Automatically apportions the optimum braking force to each wheel • Adaptive brake lights – Automatically warns other road users of heavy braking • Hill start assist – Briefly maintains rear brake pressure to stop the vehicle rolling back on an incline

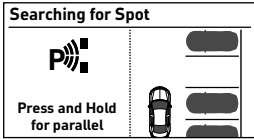

Tyre pressure

- Tyre pressure monitoring system

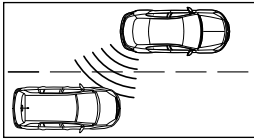
ASTRA FEATURES / OPTIONS

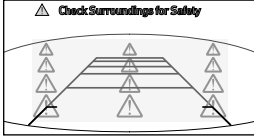
DRIVER ASSISTANCE						SC	120 Years	SRI	Elite	Ultimate	Prices including taxes (€)
Cruise control with speed limiter <i>Cruise control enables you to maintain a constant speed – making it ideal for economical motorway driving. The speed limiter function can be set to ensure that you do not exceed the speed limit and can be easily overridden if required.</i> <ul style="list-style-type: none"> Steering wheel mounted controls 						●	●	●	●	●	
Front and rear parking distance sensors <ul style="list-style-type: none"> Front and rear parking distance sensors Audible warning Distance warning graphic shown in driver information display 						○	□	○	○		250
 Easier parking											
Parking Assist Pack Advanced park assist: <i>Advanced park assist not only detects suitable parking spaces but also expertly steers into them for you. All you have to do is to drive forward or reverse. The system works with both parallel and bay parking.</i> <ul style="list-style-type: none"> Ultrasonic side sensors with four-metre range Ultrasonic front and rear parking sensors with a two-metre range Fully automated steering Detailed forward/reverse instructions are shown in the instrument cluster 											
 Finds suitable parking spaces											
 Auto steers into the parking space for you											
											
Side blind spot alert: <i>Side blind spot alert helps prevent potential collisions with other vehicles 'hidden' in the vehicle's side blind spots. If a vehicle enters one of the blind spots a warning light illuminates in the relevant door mirror.</i> <ul style="list-style-type: none"> Ultrasonic side sensors with three-metre range LED warning light in door mirrors Audible warning is sounded if the indicators are used and the system has detected another vehicle Electrically folding door mirrors (fitted as standard on Elite/Ultimate models) 								○	○	●	1000
 Warns of vehicles in your blind spot											
											
Rear-view camera: <i>The rear-view camera gives a clear view of the area behind your car and helps place the car perfectly, without needing to strain your neck.</i> <ul style="list-style-type: none"> Activated when reverse gear selected Camera view appears in infotainment screen Rear bumper and one-metre grid lines shown as reference points 											
 See what's behind you on the central screen											
											
Technology Pack A <ul style="list-style-type: none"> Front and rear parking distance sensors Rear-view camera 							○				600
Sport switch <i>Enables the driver to change the steering feel and throttle response for a sportier driving style.</i> <ul style="list-style-type: none"> Facia mounted sport switch 								●			

Prices effective as of 21.11.18. Prices are subject to alteration without notice or obligation ● = Standard equipment. ○ = Optional at extra cost. □ = Available as part of an extra-cost option pack.

ASTRA FEATURES / OPTIONS

	SC	120 Years	SRI	Elite	Ultimate	Prices including taxes (€)
DRIVER ASSISTANCE Electric parking brake <ul style="list-style-type: none"> Centre console switch in lieu of handbrake lever Premium centre console featuring adjustable armrest 			○	●	●	300
Driving Assistance Pack One Forward collision alert with automatic city emergency braking: <i>In certain circumstances and at speeds above 8km/h the collision alert warns when approaching another vehicle too quickly. At speeds above 8km/h and up to 85km/h the system provides additional braking support to help the driver brake more quickly and effectively in an emergency situation. At speeds above 8km/h and up to 60km/h if no avoiding action is taken by the driver, the system automatically slows the vehicle with emergency braking.</i> <ul style="list-style-type: none"> Visual warnings – shown in the instrument cluster Audible warning Additional braking support Low speed collision mitigation braking <div style="background-color: #e0e0e0; padding: 2px; display: inline-block;"> ✔ Warns you of potential accidents </div>						800
Traffic sign recognition: <i>Detects and then displays speed limits, reducing uncertainty and the risk of speeding.</i> <ul style="list-style-type: none"> Recognises different road signs, including temporary speed restrictions Displays reminder in the driver information centre <div style="background-color: #e0e0e0; padding: 2px; display: inline-block;"> ✔ Always know the speed limit </div>						
Following distance indicator: <i>Indicates how many seconds you are behind the vehicle in front – helping you maintain a safe distance.</i> <ul style="list-style-type: none"> Timings are shown in the driver information centre <div style="background-color: #e0e0e0; padding: 2px; display: inline-block;"> ✔ Keeps a safe distance </div>	○	□	●	○	●	
Lane departure warning with lane assist: <i>If the driver has not actively steered or signalled, the lane departure warning system warns when the car moves outside of lane markings at speeds above 56km/h. The lane keep assist function additionally provides gentle steering correction to help drivers keep in their lane if no active inputs are made.</i> <ul style="list-style-type: none"> Warning light in the instrument cluster Audible warning Steering wheel 'nudge' warning Facia on / off switch Both systems switch to standby when in road works or when road markings are confused <i>Please note: SC models are upgraded to include:</i> <ul style="list-style-type: none"> Twin front reading lights with illuminated switches Twin rear reading lights with illuminated switches Ambient LED facia/centre console downlighter Driver's and front passenger's illuminated vanity mirrors with flip-up covers Automatic lighting control with tunnel detection Automatically dimming anti-dazzle rear-view mirror Rain-sensitive windscreen wipers <div style="background-color: #e0e0e0; padding: 2px; display: inline-block;"> ✔ Keeps you in lane </div>						
Technology Pack C <ul style="list-style-type: none"> Driving Assistance Pack One IntelliLux LED Matrix headlights 		○				2000
Steering <ul style="list-style-type: none"> Speed sensitive electrically assisted power steering 	●	●	●	●	●	

Prices effective as of 21.11.18. Prices are subject to alteration without notice or obligation. ● = Standard equipment. ○ = Optional at extra cost. □ = Available as part of an extra-cost option pack.

ASTRA FEATURES / OPTIONS

	SC	120 Years	SRI	Elite	Ultimate	Prices including taxes (€)
SECURITY						
Standard security features <ul style="list-style-type: none"> • 'Key left in ignition' audible warning • Electronically protected audio equipment • Engine deadlock immobiliser • Visible Vehicle Identification Number (VIN) • Freewheeling door locks 	●	●	●	●	●	
Remote central locking <ul style="list-style-type: none"> • Operates on doors, tailgate and fuel filler flap • Deadlocking • Central locking activation switch on facia • One folding key / one static key each with integral remote control function 	●	●	●	●	●	
Keyless entry and start <ul style="list-style-type: none"> • Two transmitter fobs with back-up key • Engine start/stop button • Electrical steering column lock 			○	○	○	550
Remote control ultrasonic security alarm system <ul style="list-style-type: none"> • Remote control (operates in conjunction with central locking) • Ultrasonic interior sensors • Tilt sensor • Thatcham approved <i>Please note: Astra SC models are upgraded to include</i> <ul style="list-style-type: none"> • Twin front reading lights with illuminated switches • Twin rear reading lights with illuminated switches • Ambient LED facia / centre console downlighter • Driver's and front passenger's illuminated vanity mirrors with flip-up covers 	○	○	○	○	○	400

DRIVER INFORMATION

Instrumentation <ul style="list-style-type: none"> • Speedometer • Rev counter • Digital fuel gauge with low fuel level warning light • Digital water temperature gauge with warning light • Shift-up/down indication light – <i>Indicates when to change gear for optimum fuel economy.</i> 	●	●	●	●	●
Driver information display <ul style="list-style-type: none"> • Monochrome display (upgraded to colour on models with Navi 900) • Displays trip computer data • Total mileage • Service-due indicator • Oil life • Tyre pressure monitoring system • Centrally located in instrument cluster 	●	●	●	●	●
Multi-function trip computer <ul style="list-style-type: none"> • Trip mileage • Vehicle range based on remaining fuel • Average speed • Average fuel economy • Instantaneous fuel economy • Driving time • Displayed on driver information display • Individual tyre pressure read-out 	●	●	●	●	●
Central facia display <ul style="list-style-type: none"> • Digital clock with automatic RDS time adjustment • Outside air temperature with ice warning function • Audio information • Format and features dependent on infotainment unit 	●	●	●	●	●

Prices effective as of 21.11.18. Prices are subject to alteration without notice or obligation. ● = Standard equipment. ○ = Optional at extra cost.

ASTRA FEATURES / OPTIONS

INTERIOR STYLING	SC	120 Years	SRi	Elite	Ultimate	Prices including taxes (€)
Astra SC interior décor Steering wheel: • Three-spoke design Facia and door trim: • Black facia with Antelao Sand / Polar Silver insert • Black door panels with black Atlantis cloth inserts • Polar Silver trim inserts on front doors • Chrome-effect interior door handles Seat trim: • Talino fabric seat trim inserts • Plain black fabric side bolsters and surrounds Headlining: • Titanium roof lining	●					
Astra 120 Years Edition interior décor Steering wheel: • Three-spoke design • Leather-covered • Satin chrome-effect bezel Facia and door trim: • Jet black facia • Black door panels with black Atlantis cloth inserts • Chrome-effect interior door handles Seat trim: • Black Allure fabric seat trim inserts		●				
Astra SRi interior décor Steering wheel: • Three-spoke design • Leather-covered with accent stitching • Satin chrome-effect bezel Facia and door trim: • Black facia with Piano Black inserts • Silver air vent surrounds • Black door panels with black Atlantis cloth inserts • Piano black trim inserts on front doors • Chrome-effect interior door handles Seat trim: • Formula fabric seat trim inserts • Plain black fabric side bolsters and surrounds Headlining: • Titanium roof lining			●			
Astra Elite / Ultimate interior décor with Siena leather seat trim Steering wheel: • Three-spoke design • Leather-covered with accent stitching • Satin chrome-effect bezel Facia and door trim: • Black facia with Piano Black / Satin Chrome insert • Silver air vent surrounds • Black door panels with black Leather-effect inserts • Piano black trim inserts on front doors • Chrome-effect interior door handles Seat trim: • Black Siena leather seat trim inserts • Black leather-effect side bolsters and surrounds Headlining: • Titanium roof lining Front door sill covers: • Alloy-effect				●	●	
Astra Elite interior décor with two-tone Athena cloth seat trim (featuring comfort front seats in lieu of sports front seats) Steering wheel: • Three-spoke design • Leather-covered with accent stitching • Satin chrome-effect bezel Facia and door trim: • Black facia with Coronado Brown / Satin Chrome inserts • Silver air vent surrounds • Black door panels with light neutral cloth inserts • Coronado brown trim inserts on front doors • Chrome-effect interior door handles Seat trim: • Athena cloth seat trim inserts • Leather-effect side bolsters Headlining: • Titanium roof lining Front door sill covers: • Alloy-effect				N/C		No-cost

Prices effective as of 21.11.18. Prices are subject to alteration without notice or obligation. ● = Standard equipment. N/C = No-cost option.

ASTRA FEATURES / OPTIONS

	SC	120 Years	SRI	Elite	Ultimate	Prices including taxes (€)
SEATING AND COMFORT						
Reach and rake adjustable steering	●	●	●	●	●	
Comfort front seats Driver's seat (eight way adjustable): • Height (up/down) • Reach (fore/aft) • Backrest recline (upright/incline) • Head restraint (up/down) Front passenger's seat (six way adjustable): • Reach (fore/aft) • Backrest (upright/recline) • Head restraint (up/down)	●	●				
Sports-style front seats featuring Siena Leather Driver's and front passenger's seat (12-way adjustable): • Height (up/down) • Reach (fore/aft) • Backrest (upright/recline) • Lumbar adjustment (four-way electrical) • Head restraint (up/down) • Heated front and outer rear seats • Centre rear armrest • Heated front and outer rear seats • Centre rear armrest				●		
Driver's ergonomic active seat – AGR certified* with sports-style front passenger seat featuring Formula cloth Driver's seat (16-way adjustable): • Height (up/down) • Reach (fore/aft) • Tilt (fore/aft) • Backrest (upright/recline) • Seat cushion extension (fore/aft) • Lumbar adjustment (four-way electrical) • Head restraint (up/down) Front passenger's seat (six way adjustable): • Reach (fore/aft) • Backrest (upright/recline) • Head restraint (up/down) * = The Campaign for Healthier Backs, run by the AGR – an independent centre of excellence for ergonomics, based in Germany.	○	□	●			500
Driver's and front passenger's ergonomic active seats – AGR certified* – Changes seat trim to perforated leather on Elite models Driver's and front passenger's seat (16-way adjustable): • Height (up/down) • Reach (fore/aft) • Tilt (fore/aft) • Backrest (upright/recline) • Seat cushion extension (fore/aft) • Lumbar adjustment (four-way electrical) • Head restraint (up/down) * = The Campaign for Healthier Backs, run by the AGR – an independent centre of excellence for ergonomics, based in Germany.				○	●	500
Driver's Ergonomic Active Seat with Wellness Functions – AGR certified* (only available with optional driver's & front passenger's ergonomic active seats – AGR certified) Driver's seat additional features: • Massage function via three air cushions • Active ventilation backrest/seat cushion • Electrically operated adjustment with seat memory function • Pneumatically adjustable backrest side bolsters Front passenger's seat additional feature: • Active ventilation backrest/seat cushion				○	○	1000
Rear seating • Three person layout • Three height-adjustable and removable head restraints • ISOFIX child seat mountings incorporating top tether anchor points located on outer rear seats (does not include child seat) – Allows ISOFIX child safety seats to be securely fixed into the car. The ISOFIX mounting system reduces forward movement in an accident and makes the child seat easier to install. • Child-proof locks on rear doors • 60/40 split-folding rear seat back • 40/20/40 split-folding rear seat back (leather trim only) • Sports Tourer models additionally feature FlexFold remote electrical rear seat release	●	●	●	●	●	
Comfort Pack • Driver's ergonomic active seat • Dual-zone electronic climate control • Adjustable front armrest		○				800

Prices effective as of 21.11.18. Prices are subject to alteration without notice or obligation. ● = Standard equipment. ○ = Optional at extra cost. □ = Available as part of an extra-cost option pack.

ASTRA FEATURES / OPTIONS

INFOTAINMENT	SC	120 Years	SRI	Elite	Ultimate	Prices including taxes (€)
R4.0 IntelliLink touchscreen infotainment system Onboard features: • 7-inch colour touchscreen • AM/FM stereo radio with 36 station presets • RDS with Traffic Programme Media connections: • USB connection with iPod control • Bluetooth® A2DP audio streaming (Advanced Audio Distribution Profile) Mobile phone portal: • Bluetooth® connectivity • Handsfree calls via steering wheel controls • Vehicle microphone • Phone book access – Contacts/last calls/missed calls etc. are mirrored on IntelliLink's display and are easily navigated using the touchscreen (features dependent on mobile phone). Smartphone projection: • Apple CarPlay™ • Android Auto™ – Smartphone projection that allows operations via voice command, touchscreen and buttons to control apps and music playback.	●	●				
Navi 900 IntelliLink touchscreen navigation and infotainment system Onboard features: • 8-inch colour touchscreen • AM/FM stereo radio with 36 station presets • RDS with Traffic Programme • 60 configurable favourites including contacts, addresses, playlists, radio stations and voice recognition • Six premium speakers Navigation features: • Satellite navigation system • 3D street level mapping • European coverage Media connections: • USB connection with iPod control • Bluetooth® A2DP audio streaming (Advanced Audio Distribution Profile) Mobile phone portal: • Bluetooth® connectivity • Handsfree calls via steering wheel controls • Vehicle microphone • Phone book access – Contacts/last calls/missed calls etc. are mirrored on IntelliLink's display and are easily navigated using the touchscreen (features dependent on mobile phone). Smartphone projection: • Apple CarPlay™ • Android Auto™ – Smartphone projection that allows operations via voice command, touchscreen and buttons to control apps and music playback.	○		●	●	●	1250
DAB digital radio	●	●	●	●	●	150
CD drive (only available with Navi 900 IntelliLink)	○		○	○	○	165
Four speakers (front)						
Six speakers (four front, two rear)	●	●	●	●	●	
Steering wheel mounted audio controls for phone, music and cruise control	●	●	●	●	●	
Technology Pack B Navi R4.0 IntelliLink touchscreen infotainment system <i>For use with MP3 players, USB memory sticks, mobile phones and smartphone apps</i> Onboard features: • 7-inch colour touchscreen • DAB digital radio/AM/FM stereo radio with 36 station presets • RDS with Traffic Programme Navigation features: • Satellite navigation system Media connections: • USB connection with iPod control • Bluetooth® A2DP audio streaming (Advanced Audio Distribution Profile) Mobile phone portal: • Bluetooth® connectivity • Handsfree calls via steering wheel controls • Vehicle microphone • Phone book access – Contacts/last calls/missed calls etc. are mirrored on IntelliLink's display and are easily navigated using the touchscreen (features dependent on mobile phone). Smartphone projection: • Apple CarPlay™ • Android Auto™ – Smartphone projection that allows operations via voice command, touchscreen and buttons to control apps and music playback.		○				700

Prices effective as of 21.11.18. Prices are subject to alteration without notice or obligation. ● = Standard equipment. ○ = Optional at extra cost.

ASTRA FEATURES / OPTIONS

HEATING AND VENTILATION	SC	120 Years	SRi	Elite	Ultimate	Prices including taxes (€)
Air conditioning • Air recirculation facility • Cabin particulate filter – <i>Removes dust, airborne particles and pollen.</i> • Multi-speed fan • Illuminated controls	●	●	●	●	●	
Electronic climate control • Dual-zone control – <i>Allowing different temperature settings for driver and front passenger.</i> • Advanced predictive logic control system using sun and humidity sensors • Partial air recirculation – <i>Faster warm up/cool down.</i> • Automatic air direction and fan speed with manual override • Individual LCD temperature displays • Illuminated controls ✓ Set and forget temperature control ✓ Set different temperature for driver and front passenger		□	○	●	●	400
Additional features • Four adjustable facia vents • Windscreen demist vents • Side window demist vents • Heated rear screen with timed cut-off	●	●	●	●	●	
Winter Pack • Heated leather-covered steering wheel • Heated front seats – <i>Three temperature settings.</i> ✓ Warm welcome	○		○	●	●	500

Prices effective as of 21.11.18. Prices are subject to alteration without notice or obligation. ● = Standard equipment. ○ = Optional at extra cost. □ = Available as part of an extra-cost option pack.

ASTRA FEATURES / OPTIONS

INTERIOR CONVENIENCE / LIGHTING	<i>SC</i>	<i>120 Years</i>	<i>SRI</i>	<i>Elite</i>	<i>Ultimate</i>	Prices including taxes (€)
Convenience features <ul style="list-style-type: none"> • Front 12-volt electrical accessory socket • Driver's and front passengers sunvisors • Front passenger vanity mirror • Dipping rear-view mirror 	●	●	●	●	●	
Automatically dimming anti-dazzle rear-view mirror			●	●	●	
Twin USB power sockets for rear seat passengers – each socket provides 2.1 amps at 5 volts				●	●	
Standard lighting <ul style="list-style-type: none"> • Central front courtesy light • Central rear courtesy light • Fade up/fade down 	●	●	●	●	●	
Premium lighting <ul style="list-style-type: none"> • Twin front reading lights with illuminated switches • Twin rear reading lights with illuminated switches • Ambient LED facia/centre console downlighter • Driver's and front passenger's illuminated vanity mirrors with flip-up covers • Ambient LED lighting in front doors 			●	●	●	
Interior storage <ul style="list-style-type: none"> • Fold out storage box on driver's side lower facia • Glovebox with lid • Front door pockets • Two drinks holders in centre console • Rear door pockets • Front centre armrest with storage 	●	●	●	●	●	
Luggage area <ul style="list-style-type: none"> • Luggage compartment cover (Hatchback only) • Luggage compartment retractable cover (Sports Tourer only) • Illuminated load area • Fully carpeted load area • Interior tailgate handle • Four load restraint lashing eyes • Twin gas-assisted tailgate struts 	●	●	●	●	●	

Prices effective as of 21.11.18. Prices are subject to alteration without notice or obligation. ● = Standard equipment.

ASTRA FEATURES / OPTIONS

	SC	120 Years	SRI	Elite	Ultimate	Prices including taxes (€)
EXTERIOR LIGHTING						
Standard lighting features						
<ul style="list-style-type: none"> LED daytime running lights Automatic lighting control: <i>Headlights are automatically switched on or off depending on external lighting conditions.</i> Halogen projector headlights LED side repeat indicators Lights-on audible warning Manual headlight beam levelling High-level LED centre rear brake light Rear fog light Reversing light Hazard warning lights Door-to-door illumination: <i>Headlights remain illuminated for a limited time after leaving the vehicle.</i> 	●	●	●	●	●	
<ul style="list-style-type: none"> Automatic lighting control with tunnel detection 	●	●	●	●	●	
IntelliLux LED Matrix headlights <i>IntelliLux LED Matrix headlights provide outstanding lighting performance and enhanced safety. Each headlight features a matrix of eight individual LED lights.</i> <i>Each LED illuminates a separate part of the road ahead meaning that by automatically switching lights on and off, illumination is varied to suit traffic and road conditions.</i> <i>The IntelliLux system calculates which LED lights are activated and deactivated using additional data such as ambient light conditions, vehicle speed, steering angle and when the indicators are used. For example, when the front camera system detects an oncoming vehicle, the individual LED lights that would dazzle the oncoming driver are automatically switched off and then switched back on once the vehicle has passed. All other areas remain fully illuminated. Studies shown that the enhanced roadside illumination of IntelliLux LED Matrix headlights gives the driver an extra 1.5 seconds of reaction time at 80km/h.</i>						
<ul style="list-style-type: none"> Dipped beam, main beam and dynamic lighting: <i>16 electronically controlled LED lights (eight per headlight)</i> Driving Assistance Pack One incorporating front camera system Intelligent main beam control Automatic headlight levelling LED tail lights 						
<ul style="list-style-type: none"> ✔ Smart headlights automatically adjust the shape of high beam ✔ No need to switch between high and low beam ✔ Avoids dazzling other drivers 		□	○	○	●	1350
Every type of driving environment has been considered: Urban light: <i>With street lighting and speeds up to 54km/h, the system automatically enhances the dipped beam function.</i> Highway light: <i>The system recognises when the car is on a dual carriageway or motorway. At higher speeds the light distribution on the right is reduced to minimise glare from the crash barriers.</i> Country light: <i>As speeds increase, so does the lighting's range.</i> Static Cornering light: <i>At lower speeds corners and bends are illuminated to match steering inputs.</i> Parking light: <i>When reversing, additional side-facing lights are activated in the headlights.</i> Energy saving mode: <i>On Start/Stop models, the IntelliLux LED Matrix system goes into Energy saving mode when the engine is automatically stopped.</i>						
LED tail lights: (standard with IntelliLux LED Matrix headlights)		○	○	○	●	300
Front fog lights	●	●	●	●	●	175













Prices effective as of 21.11.18. Prices are subject to alteration without notice or obligation. ● = Standard equipment. ○ = Optional at extra cost. □ = Available as part of an extra-cost option pack.

ASTRA FEATURES / OPTIONS

	SC	120 Years	SRI	Elite	Ultimate	Prices including taxes (€)
EXTERIOR CONVENIENCE / STYLING						
Keyless entry and start • Two transmitter fobs • Engine start/stop button • Emergency key hidden inside transmitter fobs			○	○	○	550
Power tailgate (Sport Tourer only) • Handsfree electrically-operated tailgate • Opened / closed by under bumper 'foot sweep' / keyless fob / tailgate-mounted switches / driver's interior switch Restrictions: Only available with keyless entry and start option			○	○		500
Windscreen wipers • Two-speed windscreen wipers with variable intermittent wipe • Intermittent rear window wash/wipe	●	●	●	●	●	
• Rain-sensitive windscreen wipers	●	●	●	●	●	
Door mirrors • Twin electrically adjustable/heated door mirrors • Manually folding door mirrors	●	●				
• Twin electrically adjustable/heated door mirrors • Electrically folding door mirrors			●	●	●	
Windows • Electrically operated front windows with safety autoreverse and one-touch up/down facility	●	●	●	●	●	
• Electrically operated rear windows with safety autoreverse and one-touch up/down facility • Driver's deactivation switch	●	●	●	●	●	
• Solar heat-absorbing windscreen • Tinted windows • Heated rear window	●	●	●	●	●	
• Dark-tinted rear windows	●	●	○	○	●	200
Power tilt and slide sunroof • Manually operated sunblind • Sunroof can be closed remotely from outside of the vehicle <i>Please note: SC models are upgraded to include:</i> • Twin front reading lights with illuminated switches • Driver's and front passenger's illuminated vanity mirrors with flip-up covers • Twin rear reading lights with illuminated switches	○		○	○	○	650
Roof rails (Sport Tourer only) • Black	●					
• Silver-effect		●	●	●		
Towing Pack • Detachable tow bar • Trailer stability programme integrated into ESP system Restrictions: Not available with optional OPC Styling Pack	○		○	○	○	800
Body styling • Chrome-effect front grille bar • Chrome-effect headlight detail • Body-colour door handles • Body-colour door mirrors • Body-colour rear roof spoiler	●	●	●	●	●	
• Matt black B-pillars	●	●				
• Chrome-effect upper window trim • Gloss black B-pillars			●	●	●	
OPC Styling Pack • Sports-style front bumper <i>Please note: Deletes front fog lights</i> • Sports-style rear bumper • Side sills Restrictions: Not available on Sports Tourer models. Not available with 1.0i Turbo (105PS). Not available with optional Towing Pack or Aegean Blue and Flip Chip Silver exterior colours				○	○	1150
Design Pack • 17-inch gloss black five twin-spoke alloy wheels • Two-tone roof		○				600





Prices effective as of 21.11.18. Prices are subject to alteration without notice or obligation. ● = Standard equipment. ○ = Optional at extra cost.

ASTRA FEATURES / OPTIONS

EXTERIOR COLOURS		SC	120 Years	SRI	Elite	Ultimate	Prices including taxes (€)
	Aegean Blue* <ul style="list-style-type: none"> • Solid paint • Folding key with Grey insert 	●	●	●	●	●	
	Summit White <ul style="list-style-type: none"> • Brilliant paint • Folding key with White insert 	○	○	○	○	○	155
	Lava Red <ul style="list-style-type: none"> • Brilliant paint • Folding key with Red insert 	○	○	○	○	○	
	Sovereign Silver <ul style="list-style-type: none"> • Two-coat metallic paint • Folding key with Grey insert 	○	○	○	○	○	600
	Mineral Black* <ul style="list-style-type: none"> • Two-coat metallic paint • Folding key with Black insert 	○	○	○	○	○	
	Flip Chip Silver* <ul style="list-style-type: none"> • Two-coat metallic paint • Folding key with White insert • Not available with OPC exterior styling option 	○	○	○	○	○	600
	Cosmic Grey <ul style="list-style-type: none"> • Two-coat metallic paint • Folding key with Grey insert 	○	○	○	○	○	
	Darkmoon Blue* <ul style="list-style-type: none"> • Two-coat premium paint • Folding key with Black insert 	○	○	○	○	○	750
	Emerald Green* <ul style="list-style-type: none"> • Two-coat premium paint • Folding key with Black insert 	○	○	○	○	○	
	Dark Caramel <ul style="list-style-type: none"> • Two-coat premium paint • Folding key with Black insert • Not available with OPC exterior styling option 	○	○	○	○	○	750

Prices effective as of 21.11.18. Prices are subject to alteration without notice or obligation. ● = Standard equipment. ○ = Optional at extra cost. * = Not available with Design Pack on 120 Years Edition models. The colours reproduced may vary slightly from the actual paint colour. As a result they should be used as a guide only. Your Opel Dealer has a comprehensive display of our paint samples.





ASTRA FEATURES / OPTIONS

WHEELS AND TYRES		SC	120 Years	SRI	Elite	Ultimate	Prices including taxes (€)
Reduced-size 16-inch steel spare wheel <ul style="list-style-type: none"> • 115/70 R 16 tyre (speed-limited to 80km/h) • Fitted in lieu of emergency tyre inflation kit • On hatchback models this option raises the load floor to accommodate the spare wheel and tools which reduces the load capacity <i>Please note: Extra caution is required when driving on a reduced-size spare wheel. The original wheel and repaired/new tyre should be refitted at the earliest opportunity.</i>		○		○	○	○	150
Full-size 16-inch steel spare wheel (Sports Tourer models only) <ul style="list-style-type: none"> • 205/55 R 16 tyre • Fitted in lieu of emergency tyre inflation kit • Only available on models featuring 16-inch wheels 		○					150
	16-inch structure wheels <ul style="list-style-type: none"> • 205/55 R 16 tyres • Emergency tyre inflation kit (in lieu of spare wheel) 	●					200
	16-inch alloy wheels <ul style="list-style-type: none"> • 205/55 R 16 tyres • Emergency tyre inflation kit (in lieu of spare wheel) 		●				
	17-inch 10-spoke alloy wheels <ul style="list-style-type: none"> • 225/45 R 17 tyres • Emergency tyre inflation kit (in lieu of spare wheel) 	○					400
	17-inch five twin-spoke alloy wheels <ul style="list-style-type: none"> • 225/45 R 17 tyres • Emergency tyre inflation kit (in lieu of spare wheel) 			●			

Prices effective as of 21.11.18. Prices are subject to alteration without notice or obligation. ● = Standard equipment. ○ = Optional at extra cost.



ASTRA FEATURES / OPTIONS

WHEELS AND TYRES

	SC	120 Years	SRi	Elite	Ultimate	Prices including taxes (€)
 <p>17-inch multispoke alloy wheels</p> <ul style="list-style-type: none"> • 225/45 R 17 tyres • Emergency tyre inflation kit (in lieu of spare wheel) 		☐		●		tba
 <p>17-inch gloss black five twin-spoke alloy wheels</p> <ul style="list-style-type: none"> • 225/45 R 17 tyres • Emergency tyre inflation kit (in lieu of spare wheel) 		☐	○	○		150
 <p>18-inch five twin-spoke alloy wheels</p> <ul style="list-style-type: none"> • 225/40 R 18 tyres • Emergency tyre inflation kit (in lieu of spare wheel) • Not available with 1.0i Turbo (105PS) or 1.6CDTi (110PS) engines 			○			550
 <p>18-inch bi-colour alloy wheels</p> <ul style="list-style-type: none"> • 225/40 R 18 tyres • Emergency tyre inflation kit (in lieu of spare wheel) • Not available with 1.0i Turbo (105PS) or 1.6CDTi (110PS) engines 				○	●	550
<p>Fun-to-Drive Pack</p> <ul style="list-style-type: none"> • 17-inch multi-spoke alloy wheels • Dynamic chassis 		○				tba

Prices effective as of 21.11.18. Prices are subject to alteration without notice or obligation. ● = Standard equipment. ○ = Optional at extra cost. ☐ = Available as part of an extra-cost option pack.

TYRE RATING

Tyre size	Fuel efficiency group	Wet grip performance	External noise	
			Measured (dB)	Group
205/55 R 16	B-C	A-C	70-71	
225/45 R 17	C	A-B	71	
225/40 R 18	E	B	70	

Tyre rating according to EU Regulation 1222/2009

ASTRA SPECIFICATIONS

PETROL ENGINES

	1.0i Turbo (105PS) with Start/Stop	1.4i Turbo (150PS) with and without Start/Stop
Capacity	999cc	1399cc
Maximum power	105PS (77kW) @ 5500rpm	150PS (110kW) @ 5000-5600rpm
Maximum torque	170Nm (125 lb.ft.) @ 1800-4250rpm	245Nm (180 lb.ft.) @ 2000-4000rpm
Configuration	3 cylinders, 4 valves per cylinder, double overhead camshafts	4 cylinders, 4 valves per cylinder, double overhead camshafts
Fuel/induction system	Water-cooled turbocharger with intercooler. Variable Valve Timing (VVT). Central direct fuel injection	Water-cooled turbocharger with intercooler. Variable Valve Timing (VVT). Central direct fuel injection
Emission compliance	Euro 6d-TEMP (6.2) with Gasoline Particulate Filter	Euro 6d-TEMP (6.2) with Gasoline Particulate Filter
Service interval	30,000km or 1 year (whichever occurs sooner)	30,000km or 1 year (whichever occurs sooner)

DIESEL ENGINES

	1.6CDTi (110PS) Turbo diesel with Start/Stop	1.6CDTi (136PS) Turbo diesel with and without Start/Stop
Capacity	1598cc	1598cc
Maximum power	110PS (81kW) @ 3500rpm	136PS (100kW) @ 3500-4000rpm
Maximum torque	300Nm (221 lb.ft.) @ 1750-2000rpm	320Nm (236 lb.ft.) @ 2000-2250rpm
Configuration	4 cylinders, 4 valves per cylinder, double overhead camshafts	4 cylinders, 4 valves per cylinder, double overhead camshafts
Fuel/induction system	Turbocharger with intercooler. Common rail fuel injection	Variable geometry turbocharger with intercooler. Common rail fuel injection
Emission compliance	Euro 6d-TEMP (6.2) with Diesel Particulate Filter	Euro 6d-TEMP (6.2) with Diesel Particulate Filter
Service interval	30,000km or 1 year (whichever occurs sooner)	30,000km or 1 year (whichever occurs sooner)

ASTRA SPECIFICATIONS

HATCHBACK PERFORMANCE, FUEL ECONOMY AND EMISSIONS

	Wheel size (inches)	Performance (manufacturer's figures)		Urban driving	Fuel economy litres/100km [#]		CO ₂ emissions g/km [#]
		Maximum speed (km/h)	Acceleration 0-100km/h (sec)		Extra-urban driving	Combined figure	
Manual							
1.0i Turbo (105PS) Start/Stop ecoTEC	16	195	10.9	5.5	4.1	4.7	107
	17	195	10.9	5.7	4.3	4.8	110
1.4i Turbo (150PS)	17	216	7.8	7.8	4.8	5.9	136
	18	216	7.8	7.9	4.9	6.0	138
1.6CDTi (110PS) Start/Stop ecoTEC	16	200	10.4	5.1	3.5	4.1	107
	17	200	10.4	5.3	3.6	4.2	110
1.6CDTi (136PS) Start/Stop	16	212	8.8	5.3	3.9	4.4	116
	17	212	8.8	5.4	4.0	4.5	118
	18	212	8.8	5.5	4.1	4.6	121
Automatic							
1.6CDTi (136PS)	16	208	9.4	5.9	3.9	4.6	122
	17	208	9.4	6.0	4.1	4.8	126
	18	208	9.4	6.1	4.2	4.9	130

SPORTS TOURER PERFORMANCE, FUEL ECONOMY AND EMISSIONS

	Wheel size (inches)	Performance (manufacturer's figures)		Urban driving	Fuel economy litres/100km [#]		CO ₂ emissions g/km [#]
		Maximum speed (km/h)	Acceleration 0-100km/h (sec)		Extra-urban driving	Combined figure	
Manual							
1.0i Turbo (105PS) Start/Stop ecoTEC	16	195	11.1	5.5	4.1	4.6	107
1.4i Turbo (150PS)	17	214	tba	8.0	4.9	6.1	139
	18	214	tba	8.1	5.0	6.2	141
1.6CDTi (110PS) Start/Stop ecoTEC	16	200	10.7	5.4	3.6	4.3	112
	17	200	10.7	5.5	3.8	4.4	116
1.6CDTi (136PS) Start/Stop	16	212	9.0	5.4	4.0	4.5	118
	17	212	9.0	5.5	4.1	4.6	121
	18	212	9.0	5.7	4.2	4.7	125
Automatic							
1.6CDTi (136PS)	17	208	9.6	6.2	4.2	4.9	130
	18	208	9.6	6.3	4.4	5.1	134

= Fuel consumption data and CO₂ emission data are determined using the Worldwide harmonized Light vehicles Test Procedure (WLTP), and the relevant values are translated back to allow the comparability into NEDC, according to regulations R (EC) No. 715/2007, R (EU) No. 2017/1153 and R (EU) No. 2017/1151. The values do not take into account in particular use and driving conditions, equipment or options and may vary depending on the format of tyres. For more information on WLTP please see <https://www.opel.ie/wltp>

ASTRA SPECIFICATIONS

TRANSMISSION

Five-speed manual gearbox

Standard on: 1.0i Turbo (105PS)

Six-speed manual gearbox

Petrol engines: 1.4i Turbo (150PS) models

Diesel engines: 1.6CDTi (110/136PS) models

Six-speed automatic transmission with ActiveSelect® function

A six-speed automatic transmission is available on 1.6CDTi (136PS) models. On the road, a wide selection of shift patterns is adapted to the style and habits of the driver, anticipating when maximum acceleration or maximum efficiency is required. The electronic control will also adapt to the prevailing road conditions, reducing gear shifting when climbing or descending and using engine braking assistance during down changes. The ActiveSelect® manual mode allows the gear lever to be used like a sequential manual gearbox – you simply push the lever forward or back to change up or down the gears. The driver also benefits from a ‘neutral’ gear disengagement at idle, which reduces vibration and contributes to improved fuel consumption.

BRAKING AND STABILITY

- Electronic Stability Programme (ESP)
- Cornering brake control
- Straight line stability control
- Rollover mitigation
- Drag torque control
- Hill start assist
- Anti-lock Braking System (ABS)
- Emergency brake assist
- Fading brake support
- Electronic brakeforce distribution
- Adaptive brake lights

1.0i Turbo (105PS) ecoTEC

Front ventilated discs: 276mm diameter

Rear discs: 264mm diameter

1.4i Turbo (150PS)

Front ventilated discs: 276mm diameter

Rear discs: 264mm diameter

1.6CDTi (110PS)

Front ventilated discs: 276mm diameter

Rear discs: 264mm diameter

1.6CDTi (136PS)

Front ventilated discs: 300mm diameter

Rear discs: 264mm diameter

STEERING

- Power-assisted steering
- Turning circle (wall-to-wall):
– 11.05m (36.2ft.)

WEIGHTS AND TOWING DATA kg

	Gross vehicle weight		Maximum towing weights Trailer with brakes (without brakes)	
	Hatchback	Sports Tourer	Hatchback	Sports Tourer
1.0i Turbo (105PS) Start/Stop ecoTEC	1780	1850	1220 (610)	1150 (620)
1.4i Turbo (150PS)	1820	1890	1550 (620)	1500 (640)
1.6CDTi (110PS) ecoTEC	1865	1940	1500 (650)	1500 (680)
1.6CDTi (136PS) Start/Stop	1875	1950	1650 (650)	1500 (680)
1.6CDTi (136PS) automatic	1900	1975	1700 (650)	1500 (680)

Gross vehicle weight is the total permissible weight of the vehicle including passengers and their luggage. The **maximum roof rack loading** should not exceed 75kg on all models. The **maximum towing weights** are based on the ability of the car, with two occupants of 75kg each, to restart on a 12% gradient, which is approximately 1 in 8.3, at sea level. The permitted trailer load applies up to the specified incline and up to an altitude of 1000 metres above sea level. The permissible gross train weight decreases by 10% for every 1000 metres of additional altitude. Any extra weight, such as luggage or additional passengers, should be deducted from the maximum towing weight. With a trailer fully loaded, **maximum noseweight** should not exceed 75kg. Always fit Opel towing attachments and accessories available from your Opel Dealer. They are designed specifically for Opel models and carry a 12-month guarantee. During trailer towing do not exceed a maximum speed of 96km/h. This speed limit is also applicable in countries with higher permitted speeds for trailer-vehicle combinations. Pay attention to the local speed limits. For trailers with low driving stability and caravans the use of an oscillation damper is strongly recommended.

SUSPENSION

Front: Independent. Lightweight MacPherson struts with gas-pressure dampers and coil springs. Anti-roll bar.

Rear: Lightweight compound crank rear axle with one-piece, hollow cast trailing arms. Built-in anti-roll bar. Progressive-rate double conical mini-block springs and gas-pressure dampers.

BODY

Aerodynamic drag co-efficient:
Hatchback – Cd 0.285
Sports Tourer – Cd 0.278

FUEL TANK CAPACITY

48 litres (10.5 gallons)

ASTRA SPECIFICATIONS

EXTERIOR DIMENSIONS millimetres (inches)

Hatchback

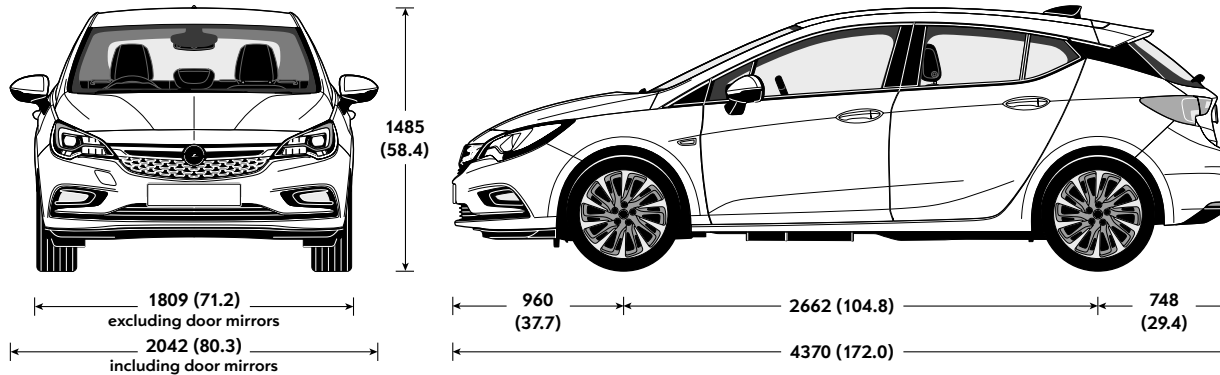

Sports Tourer

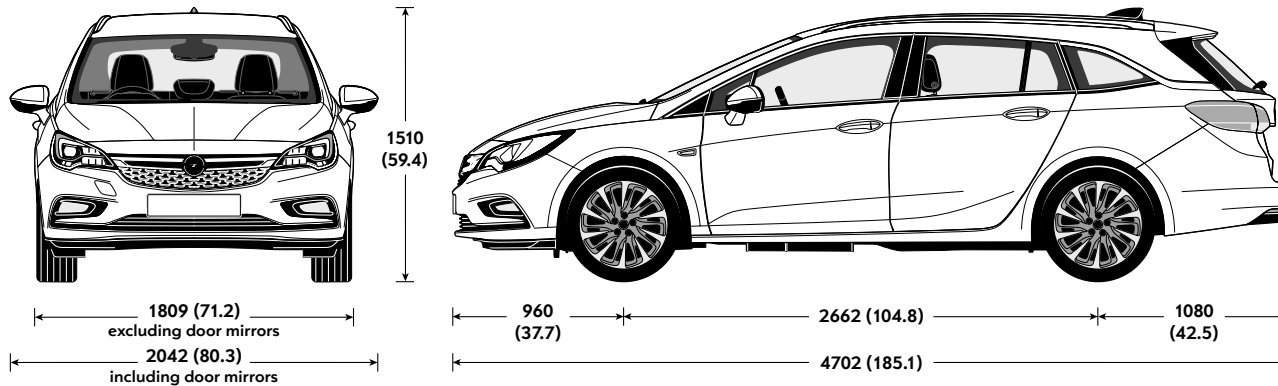

LOADSPACE DIMENSIONS mm (inches)

	Hatchback	Sports Tourer
Load floor length (rear seats folded)	1575 (62.0)	1705 (67.1)
Load floor length (behind rear seats)	828 (32.5)	1065 (41.9)
Load area width	1001 (39.4)	1050 (41.3)
Load area height	841 (33.1)	822 (32.3)
Tailgate aperture width (maximum)	1015 (39.9)	1032 (40.6)
Tailgate aperture height	600 (23.6)	747 (29.4)

LOADSPACE CAPACITIES* litres (cu.ft.)

	Hatchback	Sports Tourer
Rear seat up (under luggage compartment cover)	370 (13.0)	540 (19.0)
Rear seat down (measured to roof)	1210 (42.7)	1630 (57.5)

* = Measured using the ECIE method. When an optional spare wheel is specified loadspace capacity is reduced due to a raised luggage compartment floor.