

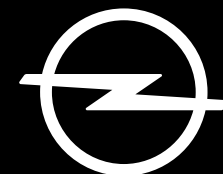

THE NEW COMBO CARGO

Price and Specification Guide
22 March 2019 | Model Year 2019.5





CONTENTS

RANGE HIGHLIGHTS

Explore the Combo Cargo range and find your perfect model.

PRICES

Find the recommended retail prices, payloads and fuel economy.

FEATURES/OPTIONS

Tailor your chosen model to suit your business needs with everything from a satellite navigation to rear-view camera and parking sensors.

EXTERIOR COLOURS

Add some sparkle to your van with a metallic paint.

WHEELS AND TYRES

Why not upgrade to a set of distinctive alloy wheels to give your van more presence.

DIMENSIONS

Ensure your van is the right size for your operational needs.

SPECIFICATIONS

Plated and towing weights, engine details and other useful details you may need to know.



COMBO CARGO RANGE HIGHLIGHTS



EDITION	OTR from €16,500*
Standard features include:	
Exterior convenience / styling:	
<ul style="list-style-type: none"> Electrically adjustable / heated door mirrors Electrically operated front windows Nearside sliding side-access door – L1 models Nearside and offside sliding side-access doors – L2 models Twin solid rear doors Emergency tyre inflation kit Side-protection mouldings 	
Interior convenience / styling:	
<ul style="list-style-type: none"> Steering column adjustable for reach and rake 	
Infotainment:	
<ul style="list-style-type: none"> AM/FM/DAB digital radio, Bluetooth® audio streaming, Bluetooth® mobile phone portal, USB audio connection with 3.5-inch display 	
Safety / security:	
<ul style="list-style-type: none"> Driver's airbag Anti-lock braking system Hill start assist Full-height steel bulkhead Daytime running lights Automatic lighting control Remote control central deadlocking Keyless entry and start – standard on automatic models Engine deadlock immobiliser Electronically protected audio equipment 	

SPORTIVE	OTR from €18,300*
Features over Edition:	
Exterior convenience / styling:	
<ul style="list-style-type: none"> Rear parking distance sensors Body-colour front and rear bumpers Metallic paint 16-inch steel wheels with 185/65 R16 tyres with full-diameter wheel trims 	
Interior convenience / styling:	
<ul style="list-style-type: none"> Steering wheel mounted audio controls Air conditioning Driver's top-lidded glovebox Height-adjustable driver's seat Four-way adjustable passenger's seat Driver's seat with manual lumbar adjustment Electronic cruise control 	
Security:	
<ul style="list-style-type: none"> Remote control security alarm system 	

LE NAV	OTR from €20,350*
Features over Sportive:	
Exterior convenience / styling:	
<ul style="list-style-type: none"> Body-colour side-protection mouldings Body-colour door handles Body-colour sliding side-access door rail cover Front fog lights Protective front skid plate 16-inch alloy wheels with 205/60 R16 tyres 	
Infotainment:	
<ul style="list-style-type: none"> Navi Intellilink <ul style="list-style-type: none"> – 8-inch colour touchscreen – Satellite navigation system 	

KEY OPTIONS	Prices including taxes.
Safety:	
Safety Pack	€800
Driver and front passenger's airbag	€350
Driver and front passenger's side-impact and curtain airbags	€425
Driving assistance:	
IntelliGrip Pack	€200
Satellite navigation system	€995
Easier parking:	
Parking Pack	€995
Practicality:	
FlexCargo Packs	From €250
Nearside and offside sliding side-access doors – L1 Panel Van	€450
Load floor covering	From €75
Winter warming:	
Winter Pack	€250

*OTR prices including VAT & VRT.



COMBO CARGO PRICES

	Minimum Mass (kg)*	Maximum Payload (kg)*	Fuel economy litres/100km#		Combined figure	CO ₂ (g/km)*	RRP inc. VAT & VRT €
			Urban driving	Extra-urban driving			
L1 EDITION PANEL VAN – EURO 6B (6.1)							
2000 1.6 (75PS) Turbo D	1378	667	4.9	4.1	4.4	114	16,500
2000 1.6 (100PS) Turbo D Start/Stop	1382	668	4.7	4.0	4.3	111	17,350
2300 1.6 (75PS) Turbo D	1394	1021	4.9	4.1	4.4	114	16,800
2300 1.6 (100PS) Turbo D Start/Stop	1395	1020	4.6	4.0	4.2	109	17,650
L1 EDITION PANEL VAN – EURO 6D TEMP (6.2)							
2000 1.5 (130PS) Turbo D Start/Stop	1437	658	4.9	4.1	4.4	117	19,050
2000 1.5 (130PS) Turbo D Start/Stop automatic	1451	654	4.6	4.2	4.3	114	21,350
2300 1.5 (130PS) Turbo D Start/Stop	1458	987	4.9	4.1	4.4	117	19,350
2300 1.5 (130PS) Turbo D Start/Stop automatic	1470	985	4.6	4.2	4.3	114	21,650
L2 EDITION PANEL VAN – EURO 6B (6.1)							
2300 1.6 (100PS) Turbo D Start/Stop	1470	955	4.6	4.1	4.3	112	18,550
L1 SPORTIVE PANEL VAN – EURO 6B (6.1)							
2000 1.6 (75PS) Turbo D	1378	667	4.9	4.1	4.4	114	18,300
2000 1.6 (100PS) Turbo D Start/Stop	1382	668	4.7	4.0	4.3	111	19,150
2300 1.6 (75PS) Turbo D	tba	tba	4.9	4.1	4.4	114	18,600
2300 1.6 (100PS) Turbo D Start/Stop	1395	1020	4.6	4.0	4.2	109	19,450
L1 SPORTIVE PANEL VAN – EURO 6D TEMP (6.2)							
2000 1.5 (130PS) Turbo D Start/Stop	1437	658	4.9	4.1	4.4	117	20,850
2000 1.5 (130PS) Turbo D Start/Stop automatic	1451	654	4.6	4.2	4.3	114	23,150
L2 SPORTIVE PANEL VAN – EURO 6B (6.1)							
2300 1.6 (100PS) Turbo D Start/Stop	1470	955	4.6	4.1	4.3	112	20,350

The above is for information purposes only as our products are continually updated and changes may be made to the specifications at any time. If you require any specific feature, you must consult your authorised Opel Dealer who is regularly updated with any change in specification. Specifications are subject to change without notice.

RRP does not include recommended delivery charge of €700. This price includes the recommended cost of PDI, number plates and delivery to an Opel Dealer. The recommended delivery charge does not include fuel supplied by the dealer, Motor insurance or any other goods or services supplied by agreement between the Dealer and the customer. Prices effective 22.3.19. Prices subject to alteration or change without notice or obligation.

* = **Minimum Mass** ('Mass in running order' on Certificate of Conformity and 'Mass in Service' on V5C form) is defined according to European Type Approval and include all fluids, tools, 90% fuel load and driver (75kg). It is minimum mass for this variant and does not consider local specification or. Weights are also subject to manufacturing tolerances (EU Legislation allows 5% tolerance). Payload figures do not allow for the weight of the driver, or any passenger's, which should therefore be deducted from the figures shown.

= Fuel consumption data and CO₂ emission data are determined using the Worldwide harmonized Light vehicles Test Procedure (WLTP), and the relevant values are translated back to allow the comparability into NEDC, according to regulations R (EC) No. 715/2007, R (EU) No. 2017/1153 and R (EU) No. 2017/1151. The values do not take into account in particular use and driving conditions, equipment or options and may vary depending on the format of tyres. For more information on official fuel consumption and CO₂ emission values, please see <https://www.opel.ie/tools/wltp-drivingcycle-fuelconsumption.html>

Vehicles with BlueInjection technology will need regular AdBlue® top-ups also between servicing requirements. An indicator integrated into the on-board computer will warn you when you need to top up. More information may be found at: www.opel.ie. In accordance with regulations R (EC) No. 715/2007 and R (EC) No. 692/2008 (in the versions respectively applicable).



COMBO CARGO PRICES

	Minimum Mass (kg)*	Maximum Payload (kg)*	Fuel economy litres/100km#		Combined figure	CO ₂ (g/km) [#]	RRP inc. VAT & VRT €
			Urban driving	Extra-urban driving			
L1 LIMITED EDITION NAV PANEL VAN – EURO 6B (6.1)							
2000 1.6 (100PS) Turbo D Start/Stop	1382	668	4.7	4.0	4.3	111	20,350
2300 1.6 (100PS) Turbo D Start/Stop	1395	1020	4.6	4.0	4.2	109	20,650
L1 LIMITED EDITION NAV PANEL VAN – EURO 6D TEMP (6.2)							
2000 1.5 (130PS) Turbo D Start/Stop	1437	658	4.9	4.1	4.4	117	22,050
L2 LIMITED EDITION NAV PANEL VAN – EURO 6B (6.1)							
2300 1.6 (100PS) Turbo D Start/Stop	1470	955	4.6	4.1	4.3	112	21,550

The above is for information purposes only as our products are continually updated and changes may be made to the specifications at any time. If you require any specific feature, you must consult your authorised Opel Dealer who is regularly updated with any change in specification. Specifications are subject to change without notice.

RRP does not include recommended delivery charge of €700. This price includes the recommended cost of PDI, number plates and delivery to an Opel Dealer. The recommended delivery charge does not include fuel supplied by the dealer, Motor insurance or any other goods or services supplied by agreement between the Dealer and the customer. Prices effective 22.3.19. Prices subject to alteration or change without notice or obligation.

* = **Minimum Mass** ('Mass in running order' on Certificate of Conformity and 'Mass in Service' on V5C form) is defined according to European Type Approval and include all fluids, tools, 90% fuel load and driver (75kg). It is minimum mass for this variant and does not consider local specification or. Weights are also subject to manufacturing tolerances (EU Legislation allows 5% tolerance). Payload figures do not allow for the weight of the driver, or any passenger's, which should therefore be deducted from the figures shown.

= Fuel consumption data and CO₂ emission data are determined using the Worldwide harmonized Light vehicles Test Procedure (WLTP), and the relevant values are translated back to allow the comparability into NEDC, according to regulations R (EC) No. 715/2007, R (EU) No. 2017/1153 and R (EU) No. 2017/1151. The values do not take into account in particular use and driving conditions, equipment or options and may vary depending on the format of tyres. For more information on official fuel consumption and CO₂ emission values, please see <https://www.opel.ie/tools/wltp-drivingcycle-fuelconsumption.html>

Vehicles with BlueInjection technology will need regular AdBlue® top-ups also between servicing requirements. An indicator integrated into the on-board computer will warn you when you need to top up. More information may be found at: www.opel.ie. In accordance with regulations R (EC) No. 715/2007 and R (EC) No. 692/2008 (in the versions respectively applicable).



FEATURES/OPTIONS

DRIVER ASSISTANCE

Mechanical parking brake

- Floor-mounted handbrake lever

Cruise control with speed limiter and intelligent speed adaptation

The cruise control feature enables you to maintain a constant speed – making it ideal for economical motorway driving. The speed limiter function can be set to ensure that you do not exceed the speed limit and can be easily overridden if required. Working in conjunction with speed sign recognition (included in optional Safety Pack), when a new speed limit is detected a message appears in the driver information display. You can then set the cruise control to the new speed limit with a simple press on a steering wheel button.
– Standard on automatic models.

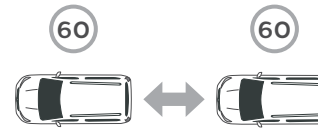

Parking sensors

- Rear parking distance sensors • Audible warning

Parking Pack

Intelligent ultrasonic sensors form part of the solution for today's crowded roads and car parks. Delivering exceptional assistance both when parking and protecting you on the open road. Only available in conjunction with Navi infotainment system.

- Front and rear parking distance sensors • Panoramic Rear-view camera
- Flank guard – Ultrasonic side sensors • Electrically adjustable / heated / power-folding door mirrors
- Front fog lights with cornering light function (standard on LE Nav)

Sight and Light Pack

- High beam assist • Rain-sensitive windscreen wipers
- 3.5-inch colour information display – Includes driver drowsiness indicator.
- Automatic anti-dazzle rear-view mirror – Only available when glazed rear door option is specified.
– Standard on automatic models.

	Option Code	Edition	Sportive	LE Nav	Prices including taxes (€)
Mechanical parking brake		●	●	●	
Cruise control with speed limiter and intelligent speed adaptation	K33	○	●	●	225
Parking sensors	UD7	○	●	●	350
Parking Pack	XIEE	○	○	○	995
Sight and Light Pack	CWX	○	○	○	300



FEATURES/OPTIONS

DRIVER ASSISTANCE CONTINUED

	Option Code	Edition	Sportive	LE Nav	Prices including taxes (€)
<p>Head-up display</p> <ul style="list-style-type: none"> • Navigation directions • Speedometer • Rev counter • Set speed of cruise control and speed limiter • Forward collision alert <p>Only available in conjunction with optional audio units. Projects key information onto the windscreen so that the driver's eyes remain on the road at all times. The display is adjustable for height and brightness</p>	UV6		O	O	375
<p>IntelliGrip Pack</p> <p>For those drivers who regularly take their vehicle off road, this pack helps the driver cope with whatever conditions they encounter. IntelliGrip traction control is designed to increase grip in difficult conditions without the additional weight of a conventional four-wheel drive system. It's an innovative grip control system that provides improved traction on certain terrain and conditions through a combination of optimised torque distribution and limited wheel spin, managed through the electronic stability programme.</p> <ul style="list-style-type: none"> • IntelliGrip: A choice of five selectable modes to suit the driving conditions: ESP on, ESP off, snow, mud, sand – Only available in conjunction with Construction Pack. 	PS4	O			200
<p>Construction Pack</p> <p>Improved protection and grip with engine sump guard/shield and Michelin Latitude Tour Mud and Snow tyres.</p> <ul style="list-style-type: none"> • Underride protection • 215/65 R16 tyres • Increased chassis height (+30mm) – Only available in conjunction with IntelliGrip Pack. 	HMG	O			800



FEATURES/OPTIONS

SAFETY

	Option Code	Edition	Sportive	LE Nav	Prices including taxes (€)
Driver / passenger airbags		●	●	●	
• Driver's airbag					
• Driver and front passenger's airbag – Standard on automatic models and when keyless entry and start is specified on LE Nav models.	AK5	○	○	○	200
• Driver and front passenger's side-impact airbags	AJ7	○	○	○	350
• Driver and front passenger's side-impact and curtain airbags	AKB	○	○	○	425
Seatbelts					
• Height-adjustable lap and diagonal inertia-reel front seatbelts					
• Front body-lock diagonal seatbelt pretensioner system – Tightens the seatbelt during the early stages of a frontal impact.					
• Drivers and front passenger's lap belt pretensioner system		●	●	●	
• Front seatbelt force limiters – Reduces potential upper body injuries during a frontal impact.					
• Anti-submarining ramps in front seats – Help prevent occupants sliding underneath the lap belt during a collision.					
Child safety					
• Deactivation switch for front passenger's front and side-impact airbags (when specified) – Permits the safe use of a child seat in the front passenger seat.		●	●	●	
Driver / passenger safety					
• Energy-absorbing steering column • Side-impact protection beams		●	●	●	
• Reinforced passenger safety cell • Deformation zones front and rear					
Braking and stability					
• Electronic stability programme • Anti-lock braking system • Corner stability control					
• Traction control • Hill start assist		●	●	●	
• Engine drag torque control – Improves directional stability by preventing the driven wheels from locking on slippery surfaces under the influence of engine braking.					
• Emergency brake assist • Electronic brakeforce distribution					



FEATURES/OPTIONS

SAFETY CONTINUED

	Option Code	Edition	Sportive	LE Nav	Prices including taxes (€)
<p>Safety Pack – Standard on automatic models.</p> <hr/> <p>Front camera system A range of class-leading driver assistance and safety features are controlled by the front camera system.</p> <hr/> <p>Lane keep assist with lane departure warning If the driver has not actively steered or signalled, the lane departure warning system provides gentle steering correction and warns when the car moves outside of lane markings at speeds above 65km/h.</p> <ul style="list-style-type: none"> • Warning light in instrument cluster • Audible warning • Facia on/off switch <hr/> <p>Speed sign recognition Detects and then displays speed limits, reducing uncertainty and the risk of speeding.</p> <hr/> <p>Driver drowsiness system The system monitors driving time and driving behaviour to help prevent accidents caused by tiredness.</p> <hr/> <p>Forward collision alert The system operates automatically from 3mph and gives an audible warning as well as a visual warning when approaching another vehicle too quickly.</p> <hr/> <p>Automatic emergency braking with pedestrian detection The system works automatically in conjunction with forward collision alert, at speeds between 5 and 140km/h, and detects both vehicles and pedestrians. If no avoiding action is taken by the driver, at speeds below 30km/h the system automatically slows the vehicle to a full stop with emergency braking of 0.9g. At speeds above 30km/h it brakes automatically to reduce speed by a maximum of 50km/h – to reduce speed even further the driver must brake him/herself. The operational speed range of the system depends on the detected obstacle (mobile target: from 5 to 140km/h; fixed target: from 5 to 80km/h; pedestrian: from 5 to 60km/h). Opel driver assistance systems are intended to support the driver within the system-imminent limitations. The driver remains responsible for the driving task.</p>	B26	○	○	○	800
<p>Tyre pressure</p> <ul style="list-style-type: none"> • Deflation detection system 	UJO	○	○	○	250
<p>Bulkhead</p> <ul style="list-style-type: none"> • Full-height steel bulkhead 		●	●	●	
<ul style="list-style-type: none"> • Full-height steel bulkhead with window 	AX9	○	○	○	250
<p>Overload indicator Prevents risk of overloading. Avoids risk of a fine for exceeding the load limit. Available 2019.</p>	J89	○	○	○	TBA





FEATURES/OPTIONS

SECURITY

	Option Code	Edition	Sportive	LE Nav	Prices including taxes (€)
Standard security features <ul style="list-style-type: none"> • Electronically protected audio equipment • Engine deadlock immobiliser • Visible Vehicle Identification Number (VIN) • Locking wheel bolts for alloy wheels (where fitted) 		●	●	●	
Remote control central locking <ul style="list-style-type: none"> • Operates on all doors and fuel filler flap • Deadlocking • Driver's internal central locking activation switch • Two folding keys, each with integral remote control function 		●	●	●	
Remote control security alarm system <ul style="list-style-type: none"> • Remote control – Operates in conjunction with central locking. • Bonnet protection – Prevents access to the engine bay. • Visible security LED on fascia • Load area protection – Monitors the load compartment preventing access. • Door protection – Monitors the position of all doors. • Ultrasonic intrusion sensor • Power alarm sounder • Vehicle theft attempt and diagnostic indication – Shows in the display any attempt to enter or steal the vehicle during driver absence. 	PS6	○	●	●	250
Keyless entry and start <p>Standard on automatic models. Only available on LE Nav models when one of the FlexCargo options is specified.</p>	ATH			○	TBA



FEATURES/OPTIONS

DRIVER INFORMATION

	Option Code	Edition	Sportive	LE Nav	Prices including taxes (€)
Instrumentation <ul style="list-style-type: none"> • Speedometer • Rev counter • Fuel gauge with low fuel level warning light • Water temperature gauge with warning light • Shift-up indication light (manual models only) – Indicates when to change gear for optimum fuel economy. 		●	●	●	
Driver information display Centrally located in instrument cluster. <ul style="list-style-type: none"> • Displays trip computer data • Total mileage • Service-due indicator 		●	●	●	
Multi-function trip computer Displayed on driver information display. <ul style="list-style-type: none"> • Trip mileage • Vehicle range based on remaining fuel • Average speed • Average fuel economy • Instantaneous fuel economy 		●	●	●	
Central facia display Format dependent on infotainment unit. <ul style="list-style-type: none"> • Audio information • Digital clock with automatic RDS time adjustment • Outside air temperature with ice warning function • Additional features dependent on infotainment unit – See infotainment for details. 		●	●	●	



FEATURES/OPTIONS

SEATING AND COMFORT

	Option Code	Edition	Sportive	LE Nav	Prices including taxes (€)
Adjustable steering column • Reach and rake-adjustable steering column		●	●	●	
Driver's seat 4-way adjustable. • Reach • Backrest recline		●			
Driver's seat 6-way adjustable. • Height • Reach • Manual lumbar adjustment • Armrest • Underseat storage	XFCF	○	●	●	350
Front passenger's seat 4-way adjustable. • Reach • Backrest recline • Manual lumbar adjustment					
Front passenger's seat • Fixed • Underseat storage		●			
Seat trim • Mistral Grey with Curitiba fabric seat trim inserts		●	●	●	
Cab flooring • Carpeted		●	●	●	



FEATURES/OPTIONS

SEATING AND COMFORT CONTINUED

	Option Code	Edition	Sportive	LE Nav	Prices including taxes (€)
FlexCargo Pack <ul style="list-style-type: none"> • Dual front passengers' fixed bench seat • Fold-flat centre seat backrest with table • Two-way foldable outer seat • Load-through bulkhead • Electric parking brake • 'Seatbelt unfastened' audible warning and warning light – Manual models only. Includes 6-way adjustable driver's seat on Edition models. 	AYW	○	○	○	250
FlexCargo Glazed Pack <ul style="list-style-type: none"> • Dual front passengers' fixed bench seat • Fold-flat centre seat backrest with table • Two-way foldable outer seat • Load-through glazed bulkhead • Electric parking brake • 'Seatbelt unfastened' audible warning and warning light – Manual models only. Available only when glazed rear door option is specified. Includes 6-way adjustable driver's seat on Edition models. 	AYV	○	○	○	315



FEATURES/OPTIONS

HEATING AND VENTILATION

	Option Code	Edition	Sportive	LE Nav	Prices including taxes (€)
Cab heating <ul style="list-style-type: none"> • Six-speed fan • Illuminated controls • Four adjustable facia vents • Windscreen demist vents • Side window demist vents 		●	●	●	
Air conditioning <ul style="list-style-type: none"> • Air recirculation facility • Cabin particulate filter – Removes dust, airborne particles and pollen. 	C60	○	●	●	1050
Electronic climate control including air conditioning <ul style="list-style-type: none"> • Dual-zone control – allowing different temperature settings for driver and front passenger. • Advanced predictive logic control system using sun sensors • Partial air recirculation – faster warm up/cool down. • Cabin particulate filter – removes dust, airborne particles and pollen. • Automatic air direction and fan speed with manual override • LCD temperature display • Illuminated controls – Only available when the Sight and Light Pack is specified.	CJ2		○	○	211
Winter Pack <ul style="list-style-type: none"> • Heated outer front seats • Heated leather-covered steering wheel – Only available when cruise control and Safety Pack are specified. Edition models require optional seating. Not available on automatic models.	XIBV	○	○	○	250



FEATURES/OPTIONS

INTERIOR CONVENIENCE AND STORAGE

	Option Code	Edition	Sportive	LE Nav	Prices including taxes (€)
Mirrors <ul style="list-style-type: none"> • Dipping rear-view mirror – When glazed bulkhead and rear doors are specified. • Driver's and front passenger's sunvisors • Vanity mirror on rear of driver's sunvisor 		●	●	●	
Front compartments <ul style="list-style-type: none"> • Two facia-mounted drinks holders • Two drinks holders in centre console • Large open storage pocket behind infotainment screen • Small open storage compartment behind gear lever • Two large and two small open door pockets • Open storage compartment below glovebox • Full-width overhead storage shelf with ambient lighting 		●	●	●	
<ul style="list-style-type: none"> • Underseat drawer (driver's side) 			●	●	



FEATURES/OPTIONS

LOAD AREA

	Option Code	Edition	Sportive	LE Nav	Prices including taxes (€)
Load floor covering					
• Plywood load floor covering	CRJ	○	○	○	200
• Vinyl load floor covering	CRK	○	○	○	75
• Load restraining straps	5C6	○	○	○	25
Illuminated load area		●	●	●	
Fixed floor-mounted load restraint lashing eyes – Six.		●	●	●	
LED illuminated load area	8G8	○	○	○	TBA
Rear roof flap – L1 models only.	AD3	○			325
Side access – Unglazed		●	●	●	
• Nearside sliding side-access door – L1 models.					
• Nearside and offside sliding side-access doors – Standard on L2 models.	CVM	○	○	○	450
Side access – Glazed					
• Fixed window in nearside sliding side-access door					
• Fixed window in opposite panel – L1 models.	BSB	○	○	○	1000
Side access – Glazed.					
• Offside sliding side-access door					
• Fixed window in nearside sliding side-access door					
• Fixed window in offside sliding side-access door – L1 models.	BSA	○	○	○	1450
Side access – Glazed.					
• Fixed window in nearside sliding side-access door		○	○	○	
• Fixed window in offside sliding side-access door – L2 Models.					1000
Rear access – Unglazed.		●	●	●	
• Twin solid rear doors					
Rear access – Glazed.					
• Twin glazed rear doors – Only available with glazed bulkhead options.	J1X	○	○	○	250



FEATURES/OPTIONS

INFOTAINMENT

	Option Code	Edition	Sportive	LE Nav	Prices including taxes (€)
<p>Radio</p> <p>Onboard features:</p> <ul style="list-style-type: none"> • AM/FM stereo radio • DAB Digital radio • RDS with Traffic Programme • 20 watts per channel output • Four speakers <p>Media connections:</p> <ul style="list-style-type: none"> • USB connection with iPod control • Bluetooth® A2DP audio streaming (Advanced Audio Distribution Profile) <p>Mobile phone portal:</p> <ul style="list-style-type: none"> • Bluetooth® connectivity • Handsfree calls via steering wheel controls • Vehicle microphone 		●	●		
<p>Multimedia</p> <p>Onboard features:</p> <ul style="list-style-type: none"> • 8-inch colour touchscreen • AM/FM stereo radio with 25 station presets • DAB Digital radio • RDS with Traffic Programme • 20 watts per channel output • Four speakers <p>Media connections:</p> <ul style="list-style-type: none"> • USB connection with iPod control • Bluetooth® A2DP audio streaming (Advanced Audio Distribution Profile) <p>Mobile phone portal:</p> <ul style="list-style-type: none"> • Bluetooth® connectivity • Handsfree calls via steering wheel controls • Vehicle microphone • Phone book access – Contacts/last calls/missed calls etc. are mirrored on the display and are easily navigated using the touchscreen (features dependent on mobile phone). <p>Smartphone interface:</p> <ul style="list-style-type: none"> • Apple CarPlay™ • Android Auto™ – Smartphone projection that allows operations via voice command, touchscreen and buttons to control apps and music playback. 	105	○	○		750



FEATURES/OPTIONS

INFOTAINMENT CONTINUED

	Option Code	Edition	Sportive	LE Nav	Prices including taxes (€)
<p>Multimedia Navi Pro</p> <p>Onboard features:</p> <ul style="list-style-type: none"> • 8-inch colour touchscreen • AM/FM stereo radio with 25 station presets • DAB Digital radio • RDS with Traffic Programme • 20 watts per channel output • Four speakers <p>Navigation features:</p> <ul style="list-style-type: none"> • Satellite navigation system • 3D street level mapping • European coverage • Structured or one-box destination entry • Points-of-interest search • Eco routing • Map updates via USB <p>Media connections:</p> <ul style="list-style-type: none"> • USB connection with iPod control • Bluetooth® A2DP audio streaming (Advanced Audio Distribution Profile) <p>Mobile phone portal:</p> <ul style="list-style-type: none"> • Bluetooth® connectivity • Handsfree calls via steering wheel controls • Vehicle microphone • Phone book access – Contacts/last calls/missed calls etc. are mirrored on the display and are easily navigated using the touchscreen (features dependent on mobile phone). <p>Smartphone interface:</p> <ul style="list-style-type: none"> • Apple CarPlay™ • Android Auto™ – Smartphone projection that allows operations via voice command, touchscreen and buttons to control apps and music playback. 	IO6	○	○	●	995
<p>Steering wheel mounted audio controls</p> <p>– Standard on automatic Edition models.</p>			●	●	
<ul style="list-style-type: none"> • 12-volt electrical accessory socket – Centre console. • 12-volt electrical accessory socket – Passenger side. • USB charging point in glovebox • USB charging / infotainment points – Infotainment unit and rear of centre console. 		●	●	●	
<p>230-volt electrical accessory socket – In lieu of passenger side 12-volt electrical accessory socket.</p>	KI5	○	○	○	150
<p>Wireless charger for mobile devices – Inductive wireless charging facility in lower fascia</p>	K4C	○	○	○	150





FEATURES/OPTIONS

EXTERIOR STYLING AND CONVENIENCE

	Option Code	Edition	Sportive	LE Nav	Prices including taxes (€)
Body styling		●	●	●	
• Nearside sliding side-access door • Twin solid rear doors • Side-protection mouldings					
• Body-colour front and rear bumper			●	●	
• Body-colour door mirrors • Body-colour side-protection mouldings • Body-colour door handles				●	
• Protective front skid plate • Body-colour sliding side-access door rail cover					
Windscreen / windows		●	●	●	
• Solar heat-absorbing windscreen • Two-speed windscreen wipers with variable intermittent wipe					
• Electrically operated front windows with safety autoreverse and one-touch facility • Tinted windows					
Door mirrors		●	●	●	
• Twin electrically adjustable / heated door mirrors • Manually folding door mirrors					
Front fog lights				●	
Tow bar pre-installation kit	JNK	○	○	○	500
Tow bar – Requires Tow bar pre-installation kit.	VTO	○	○	○	350
Roof rails	E2R	○	○	○	225



EXTERIOR COLOURS

			Option Code	Edition	Sportive	LE Nav	Prices including taxes (€)
Solid		Onyx Black	G7R	●	●	●	
		White Jade	G2O	●	●	●	
Brilliant		Ruby Red	GEO	○	N/C	N/C	155

The colours reproduced may vary slightly from the actual paint colour. As a result they should be used as a guide only. Your Opel dealer has a comprehensive display of our paint samples.

● = Standard equipment. ○ = Optional at extra cost. N/C = No-cost option.



EXTERIOR COLOURS

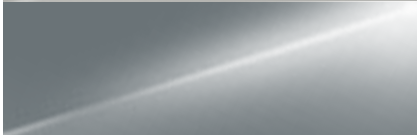
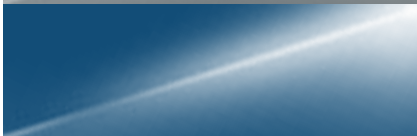
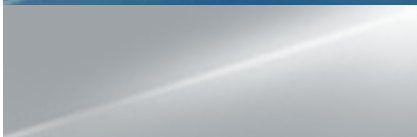
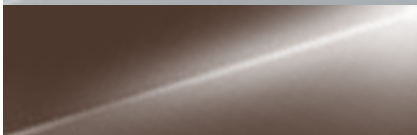

		Option Code	Edition	Sportive	LE Nav	Prices including taxes (€)	
Two-coat		Cool Grey metallic	GAC			600	
		Moonstone Grey metallic	G4O				
		Night Blue metallic	GBT	O	N/C		N/C
		Quartz Grey metallic	G4I				
		Cosmic Brown pearlescent	GLV				

The colours reproduced may vary slightly from the actual paint colour. As a result they should be used as a guide only. Your Opel dealer has a comprehensive display of our paint samples.

O = Optional at extra cost. N/C = No-cost option.



WHEELS AND TYRES

	Option Code	Edition	Sportive	LE Nav	Prices including taxes (€)
 <p>15-inch steel wheels with centre caps (2000 models)</p> <ul style="list-style-type: none"> • 185/65 R15 tyres • Emergency tyre inflation kit (in lieu of spare wheel) <p>16-inch steel wheels with centre caps (2300 models)</p> <ul style="list-style-type: none"> • 205/60 R16 tyres • Emergency tyre inflation kit (in lieu of spare wheel) 		●			
 <p>16-inch steel wheels with full-diameter wheel trims (2300 models)</p> <ul style="list-style-type: none"> • 205/60 R16 tyres • Emergency tyre inflation kit (in lieu of spare wheel) 			●		
 <p>16-inch alloy wheels</p> <ul style="list-style-type: none"> • 205/60 R16 tyres • Emergency tyre inflation kit (in lieu of spare wheel) 	RRZ		○	●	500
15-inch steel spare wheel • 185/65 R15 tyres • In lieu of emergency tyre inflation kit (2000 models)		○			150
16-inch steel spare wheel • 205/60 R16 tyres • In lieu of emergency tyre inflation kit (2300 / Sportive / LE Nav models)		○	○	○	150



DIMENSIONS

COMBO	Panel Van	
	L1	L2
Loadspace Dimensions millimetres (inches)		
Load length	1527 (60.1) – 1817 (71.5)	1877 (73.9) – 2167 (85.3)
Load length – With 'load through'	3090 (121.7)	3440 (135.4)
Maximum load height	1236 (48.7)	1243 (48.9)
Load width – With nearside side-access door	1630 (64.2)	–
Load width – With nearside and offside side-access doors	1527 (60.1)	1527 (60.1)
Maximum width between wheel arches	1229 (48.4)	1229 (48.4)
Loading height	548 (21.6) – 610 (24.0)	548 (21.6) – 610 (24.0)
Maximum rear door aperture width	1241 (48.9)	1241 (48.9)
Maximum rear door aperture height	1196 (47.1)	1196 (47.1)
Maximum side-access aperture width	675 (26.6)	675 (26.6)
Maximum side-access aperture height	1072 (42.2)	1072 (42.2)
Loadspace Volumes cu.m (cu.ft.)		
Panel Van	3.3 (116.5)	3.9 (137.7)
Panel Van – With 'load through'	3.8 (134.2)	4.4 (155.4)

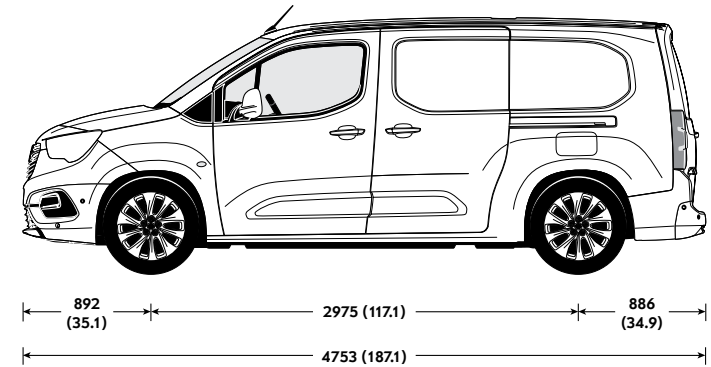
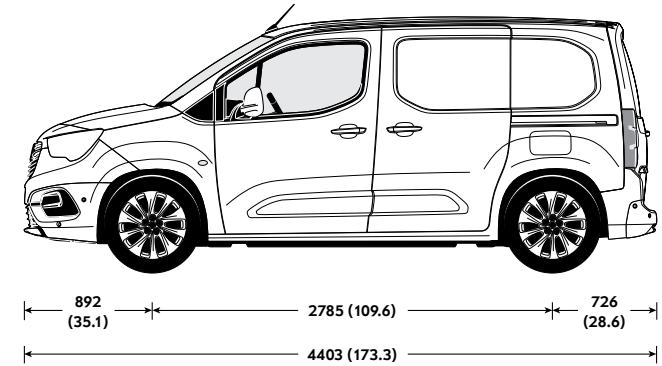
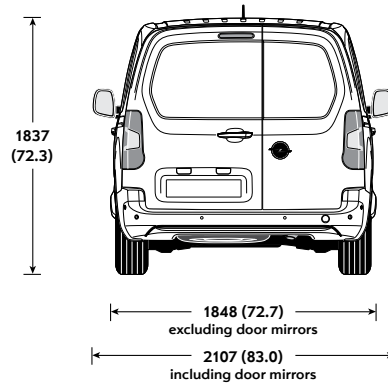
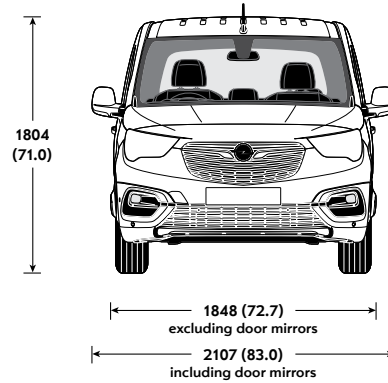



SPECIFICATIONS

Transmission

- Front-wheel drive
- Five-speed manual gearbox
 - 1.6 (75/100PS) Turbo D models
- Six-speed manual gearbox – 1.5 (130PS) Turbo D/1.2 (110PS) Turbo* models
- Eight-speed automatic transmission – available on 1.5 (130PS) Turbo D/1.2 (130PS) Turbo* models

Replacing the traditional lever, the automatic transmission selection-mode dial/drive wheel is an innovative solution that is both elegant and intuitive. By simply twisting the dial, the following modes can be selected:

- Park, for when the vehicle is stationary and the wheels are locked
- Drive, for automatic forward motion
- Neutral, for when the vehicle is stationary, wheels are free
- Reverse, for automatic backward motion

For an extra experience of dynamism, the shift paddles for automatic transmissions are located behind the steering wheel, offering drivers an extra level of control that is highly ergonomic and intuitive. The shift paddles function in the following way:

- To go up a gear, the driver must pull the right lever towards themselves
- To go down a gear, the driver must pull the left lever towards themselves**

Steering

- Speed-sensitive electric power-assisted system
- Turning circle (kerb-to-kerb) –
 - 11.0m (36 ft) L1 models, 11.8m (38.7 ft) L2 models

Suspension

Front: Independent. MacPherson struts with gas-pressure dampers and linear-rate coil springs. Anti-roll bar

Rear: Torsion beam with gas-pressure dampers and constant-rate coil springs (variable-rate on 2300 models)

Roof Loads

- Combo roof load should not exceed 100kg including the weight of the roof rack/carrier

Fuel Tank Capacity

- 61 litres (13.0 gallons) – Petrol models*
- 50 litres (10.9 gallons) – Diesel models

AdBlue Tank Capacity

- 17 Litres (3.7 gallons)



PLATED WEIGHTS AND TOWING DATA – KG

	Plated weights*			Towing weights		Plated Gross Combination Weights (GCW)
	Gross Vehicle Weights (GVW)	Front axle	Rear axle	Braked	Unbraked	
L1 EDITION PANEL VAN						
2000 1.6 (75PS) Turbo D	1970	1110	1075	1000	730	2970
2000 1.6 (100PS) Turbo D Start/Stop	1975	1110	1075	1200	600	3175
2000 1.5 (130PS) Turbo D Start/Stop	2020	1110	1075	1500	730	3520
2000 1.5 (130PS) Turbo D Start/Stop automatic	2030	1200	1075	1350	600	3380
2300 1.6 (75PS) Turbo D	2340	1200	1400	750	730	3090
2300 1.6 (100PS) Turbo D Start/Stop	2340	1200	1400	850	600	3190
2300 1.5 (130PS) Turbo D Start/Stop	2370	1200	1400	1200	730	3570
2300 1.5 (130PS) Turbo D Start/Stop automatic	2380	1200	1400	1000	600	3380
L2 EDITION PANEL VAN						
2300 1.6 (100PS) Turbo D Start/Stop	2350	1200	1400	850	600	3200
L1 SPORTIVE PANEL VAN						
2000 1.6 (100PS) Turbo D Start/Stop	1975	1110	1075	1200	600	3175
2000 1.5 (130PS) Turbo D Start/Stop	2020	1110	1075	1500	730	3520
2000 1.5 (130PS) Turbo D Start/Stop automatic	2030	1110	1075	1350	730	3380
2300 1.6 (100PS) Turbo D Start/Stop	2340	1200	1400	850	600	3190
L2 SPORTIVE PANEL VAN						
2300 1.6 (100PS) Turbo D Start/Stop	2350	1200	1400	850	600	3200

*Provisional data.

Gross plated weights (including axle weights) quoted on the vehicle plate are to UK plated weight specification and must never be exceeded.



PLATED WEIGHTS AND TOWING DATA – KG

	Plated weights*			Towing weights		Plated Gross Combination Weights (GCW)
	Gross Vehicle Weights (GVW)	Front axle	Rear axle	Braked	Unbraked	
L1 LIMITED EDITION NAV PANEL VAN						
2000 1.6 (100PS) Turbo D Start/Stop	1975	1110	1075	1200	600	3175
2000 1.5 (130PS) Turbo D Start/Stop	2020	1110	1075	1500	600	3520
2300 1.6 (100PS) Turbo D Start/Stop	2340	1200	1400	850	730	3190
L2 LIMITED EDITION NAV PANEL VAN						
2300 1.6 (100PS) Turbo D Start/Stop	2350	1200	1400	850	730	3200

*Provisional data.

Gross plated weights (including axle weights) quoted on the vehicle plate are to UK plated weight specification and must never be exceeded.



PETROL ENGINES*

Engine	1.2 (110PS) Turbo Start/Stop	1.2 (130PS) Turbo Start/Stop
Capacity	1199cc	1199cc
Maximum power	110PS (81kW) @ 5500rpm	130PS (96kW) @ 5500rpm
Maximum torque	205Nm (151 lb.ft.) @ 1750rpm	230Nm (170 lb.ft.) @ 1750rpm
Configuration	3 cylinders, 4 valves per cylinder, double overhead camshafts	3 cylinders, 4 valves per cylinder, double overhead camshafts
Fuel/induction system	Turbocharger. Variable Valve Timing. Direct fuel injection	Turbocharger. Variable Valve Timing. Direct fuel injection
Emission compliance	Euro 6d-TEMP (6.2)	Euro 6d-TEMP (6.2)
Service interval	20,000 kilometres or 1 year (whichever occurs sooner)	20,000 kilometres or 1 year (whichever occurs sooner)



DIESEL ENGINES

Engine	1.6 (75PS) Turbo D BlueInjection	1.6 (100PS) Turbo D Start/Stop BlueInjection	1.5 (130PS) Turbo D Start/Stop BlueInjection
Capacity	1560cc	1560cc	1499cc
Maximum power	75PS (55kW) @ 3500rpm	100PS (75kW) @ 3750rpm	130PS (96kW) @ 3750rpm
Maximum torque	210Nm (155 lb.ft.) @ 1750rpm	250Nm (184 lb.ft.) @ 1750rpm	300Nm (221 lb.ft.) @ 1750rpm
Configuration	4 cylinders, 4 valves per cylinder, double overhead camshafts	4 cylinders, 4 valves per cylinder, double overhead camshafts	4 cylinders, 4 valves per cylinder, double overhead camshafts
Fuel/induction system	Turbocharger with intercooler. Common rail fuel injection	Turbocharger with intercooler. Common rail fuel injection	Variable-nozzle turbocharger with electric switching. Common rail direct injection
Emission compliance	Euro 6b (6.1)	Euro 6b (6.1)	Euro 6d-TEMP (6.2)
Service interval	25,000 kilometres or 1 year (whichever occurs sooner)	25,000 kilometres or 1 year (whichever occurs sooner)	40,000 kilometres or 2 years (whichever occurs sooner)

Vehicles with BlueInjection technology will need regular AdBlue® top-ups also between servicing requirements. An indicator integrated into the on-board computer will warn you when you need to top up. More information under www.opel.ie in accordance with regulations R (EC) No. 715/2007 and R (EC) No. 692/2008 (in the versions respectively applicable).