

MOKKA X

PRICES AND SPECIFICATIONS

2019 models. Prices effective 31 August 2018



MOKKA X RANGE HIGHLIGHTS



MOKKA X SC

Highlights

- Radio 4.0 IntelliLink
- Front and rear parking distance sensors
- Dual-zone electronic climate control
- Front fog lights
- 17-inch alloy wheels

Infotainment:

- Radio 4.0 IntelliLink
- 7-inch colour touchscreen with DAB/FM/AM Radio
- Smartphone connectivity for your phone, messaging, music, maps and apps
- Apple CarPlay™ and Google Android Auto™ app projection†
- Siri / Google Now voice command for phone, messaging, music and calendar
- Steering wheel controls for phone, music and cruise control
- Bluetooth® phone, messaging and music streaming
- USB and Aux-in connection

Interior/styling features:

- Dual-zone electronic climate control
- Front centre armrest
- Leather-covered steering wheel
- Steering column adjustable for reach and rake
- 60/40 split, flip and fold rear seat

Exterior/styling features:

- Automatic lighting control
- Electrically adjustable/heated door mirrors
- Electrically operated front and rear windows
- Rain-sensitive windscreen wipers
- Front and rear parking distance sensors
- Electrically foldable door mirrors
- High beam assist
- Front fog lights
- Sterling silver-effect 17-inch alloy wheels

Safety features:

- Switchable Electronic Stability Programme (ESP)
- Anti-lock Braking System (ABS)
- LED daytime running lights
- Hill start assist
- Emergency brake assist
- Adaptive brake lights
- Straight line stability control
- Cornering brake control
- Rollover mitigation
- Traction control
- Electronic brakeforce distribution
- Six airbags
- Two rear seat ISOFIX restraints
- Tyre pressure monitoring system

4X4 models also feature:

- Intelligent four-wheel drive
- Descent control system



MOKKA X ELITE

Highlights

- Navi 900 IntelliLink
- Front and rear parking distance sensors
- Leather seat trim
- Ergonomic sports front seats
- 18-inch alloy wheels

Infotainment:

- As SC, plus:
- Navi 900 IntelliLink
- 8-inch colour touchscreen
- Voice command for audio and integrated navigation
- Satellite navigation

Interior/styling features:

- As SC, plus:
- Leather-covered ergonomic sports front seats with extendable cushions
- Four-way electric lumbar adjustment
- Heated steering wheel and front seats
- Rear seat centre armrest with drinks holders

Exterior/styling features:

- As SC, plus:
- Dark-tinted rear windows
- 18-inch multi-spoke alloy wheels
- Alloy-effect door sill covers

Safety features:

- As SC
- 4X4 models also feature:
- Intelligent four-wheel drive
- Descent control system

MOKKA X 5-DOOR SUV PRICES

Trim	Engine	Transmission	CO ₂	Tax Band	Tax €	RRP €
DIESEL ENGINES						
SC	1.6CDTi (136PS) Start/Stop ecoTEC	Manual	127	B1	270	27,335
SC	1.6CDTi (136PS)	Automatic	143	C	390	30,880
Elite	1.6CDTi (136PS) Start/Stop	Manual	131	B2	280	29,785
Elite	1.6CDTi (136PS) Start/Stop 4X4	Manual	146	C	390	31,930
Elite	1.6CDTi (136PS)	Automatic	149	C	390	33,330
PETROL ENGINES						
SC	1.4i Turbo (140PS) Start/Stop ecoTEC	Manual	147	C	390	25,245
SC	1.4i Turbo (140PS)	Automatic	157	D	570	27,745
Elite	1.4i Turbo (140PS) Start/Stop ecoTEC	Manual	150	C	390	28,945
Elite	1.4i Turbo (140PS) Start/Stop 4X4	Manual	167	D	570	30,545
Elite	1.4i Turbo (140PS)	Automatic	162	D	570	31,445

The above is for information purposes only as our products are continually updated and changes may be made to the specifications at any time. If you require any specific feature, you must consult your authorised Opel Dealer who is regularly updated with any change in specification. Specifications are subject to change without notice.

RRP does not include recommended delivery charge of €700. This price includes the recommended cost of PDI, number plates and delivery to an Opel Dealer. The recommended delivery charge does not include fuel supplied by the dealer, Motor insurance or any other goods or services supplied by agreement between the Dealer and the customer.

Prices effective 31.8.18. Prices subject to alteration or change without notice or obligation.

MOKKA X FEATURES / OPTIONS

SAFETY

Driver / passenger airbags

- Driver's airbag • Front passenger's airbag • Front seat side-impact airbags
- Full-size curtain airbags for driver, front seat passenger and outer rear seat passengers

Seating

- Height-adjustable front seat head restraints • Height-adjustable outer rear seat head restraints

Seatbelts

- Height adjustable front inertia-reel lap and diagonal seatbelts • Three inertia-reel lap and diagonal rear seatbelts • Front body-lock diagonal seatbelt pretensioner system – *Tightens the seatbelt during the early stages of a frontal impact, limiting forward movement.* • Driver's and front passenger's lap belt pretensioner system • Front seatbelt force limiters – *Reduces potential upper body injuries during a frontal impact.* • Front and rear 'seatbelt unfastened' warning light

Child safety

- Deactivation switch for front passenger's front and side-impact airbags – *Permits the safe use of a child seat in the front passenger seat.* • ISOFIX child seat mountings incorporating top tether anchor points located on outer rear seats (does not include child seat) – *Allows ISOFIX child safety seats to be securely fixed into the car. The ISOFIX mounting system reduces forward movement in an accident and makes the child seat easier to install.*

Driver / passenger safety

- Energy-absorbing steering column • Pedal release system – *Reduces potential injury to the driver's legs and feet during a severe frontal impact.* • Laminated windscreen • Side-impact protection beams • Reinforced passenger safety cell • Deformation zones front and rear
- Burst-proof door locks and anti-jam door design

Pedestrian safety

- Collapsible windscreen wiper system – *Designed to reduce pedestrian head injuries.*
- Upper and lower bumper design – *Reduces upper and lower leg injuries.*

Stability

Switchable Electronic Stability Programme (ESP):

– Works in conjunction with the vehicle's electronic braking and engine systems to keep the car stable in many different situations. ESP monitors many different inputs to determine when the car starts to lose traction, it can then immediately respond by varying the brake pressure between up to three wheels and adjust the engine output to help correct the loss of traction and improve stability.

Additional ESP features:

- Cornering brake control • Straight line stability control
- Descent control system (4X4 models only) • Rollover mitigation
- Traction control

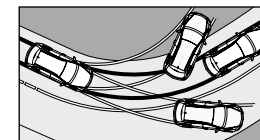

Braking

Anti-lock Braking System (ABS):

– Prevents the vehicle's wheels from locking up under heavy braking by momentarily reducing brake pressure at the appropriate wheel, ensuring that you can maintain control of the steering.

Additional braking features:

– The same electronic systems used in the ABS and ESP also deliver exceptional braking performance.

- Emergency brake assist – *When emergency braking is detected the vehicle automatically applies the maximum possible braking assistance.*
- Electronic brakeforce distribution – *Automatically apportions the optimum braking force to each wheel.*
- Adaptive brake lights – *Automatically warns other road users of heavy braking.*
- Hill start assist – *Briefly maintains rear brake pressure to stop the vehicle rolling back on an incline.*
- Hazard warning lights

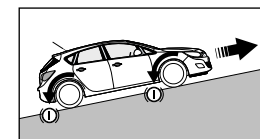

Tyre pressure

- Tyre pressure monitoring system

MOKKA X FEATURES / OPTIONS

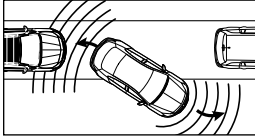
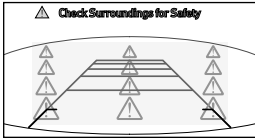
DRIVER ASSISTANCE		SC	Elite	Prices including taxes (€)
Steering <ul style="list-style-type: none"> • Speed-sensitive power-assisted steering 	●	●		
Cruise control with speed limiter <p><i>The cruise control feature enables you to maintain a constant speed – making it ideal for economical motorway driving.</i></p> <p><i>The speed limiter function can be set to ensure that you do not exceed the speed limit and can be easily overridden if required.</i></p> <ul style="list-style-type: none"> • Steering wheel mounted controls 	●	●		
Parking sensors <ul style="list-style-type: none"> • Front and rear parking distance sensors • Audible warning <p>✓ Easier parking</p>		●	●	
Rear-view camera <p><i>The rear-view camera gives a clear view of the area behind your car and helps place the car perfectly, without needing to strain your neck.</i></p> <ul style="list-style-type: none"> • Activated when reverse gear selected • Camera view appears in infotainment screen • Rear bumper and one-metre grid lines shown as reference points. <p>✓ See what's behind you on the central screen</p>		○	○	400

Prices effective as of 31.8.18. Prices are subject to alteration without notice or obligation. ● = Standard equipment. ○ = Optional at extra cost.

MOKKA X FEATURES / OPTIONS

	SC	Elite	Prices including taxes (€)
SECURITY			
Standard security features			
<ul style="list-style-type: none"> • Electronically protected audio equipment • Engine deadlock immobiliser • Visible Vehicle Identification Number (VIN) • Locking wheel nuts • Foldable luggage area cover 	●	●	
Remote control central locking			
<ul style="list-style-type: none"> • Operates on doors, tailgate and fuel filler flap • Deadlocking • Driver's internal central locking activation switch • One folding key/one static key each with integral remote control function 	●	●	
Remote control security alarm system			
<ul style="list-style-type: none"> • Remote control (operates in conjunction with central locking) 	●	●	
DRIVER INFORMATION			
Instrumentation			
<ul style="list-style-type: none"> • Speedometer • Rev counter • Fuel gauge with low fuel level warning light • Water temperature gauge with warning light • Shift-up indication light (manual models only) – <i>Indicates when to change gear for optimum fuel economy.</i> 	●	●	
Driver information display (centrally located in instrument cluster)			
<ul style="list-style-type: none"> • Monochrome display • Displays trip computer data • Total mileage • Service-due indicator • Oil life • Tyre pressure monitoring system 	●	●	
Driver information display with ecoTEC Drive Assist (Start/Stop models only):			
<i>Includes information on which electrical items are using the most energy, fuel consumption statistics for the last 30 miles and when to change gear to help maximise economy.</i>			
Multi-function trip computer (displayed on driver information display)			
<ul style="list-style-type: none"> • Trip mileage • Vehicle range based on remaining fuel • Average speed • Average fuel economy • Instantaneous fuel economy 	●	●	
Central facia display (format dependent on infotainment unit)			
<ul style="list-style-type: none"> • Audio information • Digital clock with automatic RDS time adjustment • Outside air temperature with ice warning function • Additional features dependent on infotainment unit (see infotainment for details) 	●	●	

Prices effective as of 31.8.18. Prices are subject to alteration without notice or obligation. ● = Standard equipment. ○ = Optional at extra cost.

MOKKA X FEATURES / OPTIONS

INTERIOR STYLING	<i>SC</i>	<i>Elite</i>	Prices including taxes (€)
SC interior décor Steering wheel: • Three-spoke design • Leather-covered • Satin chrome-effect bezel Facia and door trim: • Black facia • Black door panels with black Atlantis cloth inserts • Chrome-effect interior door handles Seat trim: • Milano fabric seat trim inserts • Plain black fabric side bolsters and surrounds	●		
Elite interior décor with Black Jasmin leather seat trim Steering wheel: • Three-spoke design • Leather-covered • Satin chrome-effect bezel Facia and door trim: • Black facia • Black door panels with black leather-effect inserts • Chrome-effect interior door handles Seat trim: • Black Jasmin leather seat trim inserts • Black leather-effect side bolsters and surrounds Front door sill covers: • Alloy-effect		●	
Elite interior décor with Morello Red Jasmin leather seat trim (not available with Aegean Blue, Lava Red, Darkmoon Blue, Satin steel Grey and Amber Orange exterior colours) Steering wheel: • Three-spoke design • Leather-covered • Satin chrome-effect bezel Facia and door trim: • Black facia • Black door panels with black leather-effect inserts • Chrome-effect interior door handles Seat trim: • Morello Red Jasmin leather seat trim inserts • Morello Red leather-effect side bolsters and surrounds Front door sill covers: • Alloy-effect		N/C	

Prices effective as of 31.8.18. Prices are subject to alteration without notice or obligation. ● = Standard equipment. N/C = No-cost option.

MOKKA X FEATURES / OPTIONS



INFOTAINMENT	SC	Elite	Prices including taxes (€)
R4.0 IntelliLink touchscreen infotainment system <i>For use with MP3 players, USB memory sticks, mobile phones and smartphone apps</i> Onboard features: • 7-inch colour touchscreen • Digital radio/AM/FM stereo radio with 36 station presets • RDS with Traffic Programme Media connections: • USB connection with iPod control • Aux-in socket • Bluetooth® A2DP audio streaming (Advanced Audio Distribution Profile) Mobile phone portal: • Bluetooth® connectivity • Handsfree calls via steering wheel controls • Vehicle microphone • Phone book access – <i>Contacts/last calls/missed calls etc. are mirrored on IntelliLink's display and are easily navigated using the touchscreen (features dependent on mobile phone).</i> Smartphone interface: • Apple CarPlay™ • Android Auto™	●		
Navi 900 IntelliLink touchscreen navigation and infotainment system <i>For use with MP3 players, USB memory sticks, mobile phones and smartphone apps</i> Onboard features: • 8-inch colour touchscreen • Digital radio/AM/FM stereo radio with 36 station presets • RDS with Traffic Programme • 60 configurable favourites including contacts, addresses, playlists, radio stations and voice recognition Navigation features: • Satellite navigation system • 3D street level mapping • European coverage Media connections: • USB connection with iPod control • Aux-in socket • Bluetooth® A2DP audio streaming (Advanced Audio Distribution Profile) Mobile phone portal: • Bluetooth® connectivity • Handsfree calls via steering wheel controls • Vehicle microphone • Phone book access – <i>Contacts/last calls/missed calls etc. are mirrored on IntelliLink's display and are easily navigated using the touchscreen (features dependent on mobile phone).</i> Smartphone interface: • Apple CarPlay™ • Android Auto™	○	●	1250
Bose® Premium Sound System (only available with Navi 900 IntelliLink and optional spare wheel) • Six channel amplifier with digital signal processing • Two A-pillar mounted 2.5cm tweeters • Two front door mounted 16.5cm woofers • Two rear door mounted 13cm wide-range speakers • One 13cm Richbass woofer in custom 8-litre bass box in luggage compartment	○	○	700
Six speakers (four front, two rear)	●	●	
Steering wheel mounted audio controls	●	●	
OnStar personal assistant* • Emergency and crash response • Wi-Fi hotspot • Stolen vehicle alert • Smartphone vehicle diagnostics app • Destination download • Roadside Assistance call out	○	○	500

Prices effective as of 31.8.18. Prices are subject to alteration without notice or obligation. ● = Standard equipment. ○ = Optional at extra cost.

All OnStar services and Wi-Fi services will cease to be available on 31 December 2020. No trial or paid subscriptions or services, including emergency response services, will be available after that date.

* = Includes 12 months of OnStar services (excluding Wi-Fi data charges) from date of first registration. Destination download is available on models with an embedded Opel navigation system. Roadside Assistance call out is subject to your vehicle being within its Opel Roadside Assistance cover period. If your car is out of Opel Roadside Assistance coverage or Policy Terms, the AA may charge for their time.

MOKKA X FEATURES / OPTIONS

	SC	Elite	Prices including taxes (€)
SEATING AND COMFORT			
Reach and rake adjustable steering	●	●	
Comfort front seats Driver's seat (eight-way adjustable): • Height (up/down) • Reach (fore/aft) • Backrest recline (upright/incline) • Head restraint (up/down) Front passenger's seat (six-way adjustable): • Reach (fore/aft) • Backrest (upright/recline) • Head restraint (up/down)	●		
Ergonomic active front seats (AGR-approved†) featuring Jasmin Leather Driver's and front passenger's seat (18-way adjustable): • Height (up/down) • Reach (fore/aft) • Tilt (electrical fore/aft) • Backrest (upright/recline) • Seat cushion extension (fore/aft) • Lumbar adjustment (four-way electrical) • Head restraint (up/down/fore/aft) • Heated front seats		●	
Ergonomic active front driver's seat (AGR-approved†)	○		400
Rear seating • Three-person layout • 60/40 split flip and fold rear seat • Height-adjustable and removable outer seat head restraints • ISOFIX child seat mountings incorporating top tether anchor points located on outer rear seats (does not include child seat) – Allows ISOFIX child safety seats to be securely fixed into the car. The ISOFIX mounting system reduces forward movement in an accident and makes the child seat easier to install. • Child-proof locks on rear doors	●	●	
Centre rear seat head restraint		●	
HEATING AND VENTILATION			
Electronic climate control including air conditioning • Dual-zone control – Allowing different temperature settings for driver and front passenger. • Advanced predictive logic control system using humidity sensors • Partial air recirculation – Faster warm up/cool down • Cabin particulate filter – Removes dust, airborne particles and pollen. • Automatic air direction and fan speed with manual override • Illuminated controls	●	●	
Additional features • Four adjustable facia vents • Windscreen demist vents • Side window demist vents • Heated rear screen with timed cut-off	●	●	
Winter Pack • Heated leather-covered steering wheel • Heated front seats    Warm welcome	○	●	404

Prices effective as of 31.8.18. Prices are subject to alteration without notice or obligation. ● = Standard equipment. ○ = Optional at extra cost. † = AGR (The Campaign for Healthier Backs) is an independent centre of excellence for ergonomics, based in Germany.

MOKKA X FEATURES / OPTIONS

	SC	Elite	Prices including taxes (€)
INTERIOR CONVENIENCE			
Convenience features • Front 12-volt electrical accessory socket • Front and rear passenger assist handles	●	●	
12-volt power outlet behind front seats	●	●	
Driver's and front passenger's illuminated vanity mirrors with flip-up cover	●	●	
Automatically dimming anti-dazzle rear-view mirror	●	●	
Front driver's armrest	●	●	
Rear seat centre armrest with drinks holders		●	
INTERIOR LIGHTING			
Standard lighting • Courtesy lighting operated by door switches	●	●	
INTERIOR STORAGE			
Interior storage • Illuminated glovebox with lid • Front door pockets • Storage pocket on front passenger's seat back • Two drinks holders in centre console	●	●	
• Storage pocket on driver's seat back	●	●	
• Front passenger's underseat storage tray	●		
Luggage area • Luggage compartment foldable cover • Illuminated luggage area • Fully carpeted luggage area	●	●	

Prices effective as of 31.8.18. Prices are subject to alteration without notice or obligation. ● = Standard equipment.

MOKKA X FEATURES / OPTIONS

	SC	Elite	Prices including taxes (€)
MECHANICAL			
Front-wheel drive	●	●	
Intelligent four-wheel drive (4X4 models only)	▲	▲	
Six-speed manual gearbox	●	●	
Six-speed automatic transmission (1.4i (140PS) and 1.6CDTi (136PS) models only)	▲	▲	
EXTERIOR LIGHTING			
Standard lighting features <ul style="list-style-type: none"> • LED daytime running lights • Automatic lighting control • Halogen headlights • Lights-on audible warning • Manual headlight beam levelling • High beam assist • High-level LED centre rear brake light • Rear fog light • Reversing light • Hazard warning lights • Door-to-door illumination 	●	●	
Front fog lights	●	●	
LED tail lights (standard with optional Premium LED Adaptive Forward Lighting)	○	○	200
Premium LED Adaptive Forward Lighting (AFL) Six LED elements light the road 30% brighter than halogen, allowing you to see hazards sooner and giving you more time to react. The AFL system uses data such as vehicle speed, steering angle and when the indicators are used to determine the most suitable lighting. <ul style="list-style-type: none"> • Enhanced colour driver information display • Intelligent main beam control • Automatic headlight levelling • LED tail lights Every type of driving environment has been considered: Urban light: With street lighting and speeds below 56km/h, the system automatically enhances the dipped beam function. Country light: As speeds increase, so does the lighting's performance. Dynamic curve light: At speeds between 40km/h and 72km/h, and above a set steering angle, extra light is projected onto the relevant side of the road to give you a better view. Static cornering light: At lower speeds, when you indicate and turn the steering above a certain angle, corners and bends are illuminated to match steering inputs. Parking light: When reversing, additional side-facing lights are activated in the headlights. Energy saving mode: On Start/Stop models, the system deactivates the static cornering light function when Start/Stop mode is active. Tourist mode: If you're driving on the continent, switch to Tourist mode and your lights will dip automatically for oncoming traffic. High beam: Powerful down-the-road illumination on top of the LED low beam. Full-on lighting for maximum visibility.	○	○	1350











Prices effective as of 31.8.18. Prices are subject to alteration without notice or obligation. ● = Standard equipment. ○ = Optional at extra cost. ▲ = See price page for details.

MOKKA X FEATURES / OPTIONS

	SC	Elite	Prices including taxes (€)
EXTERIOR CONVENIENCE			
Windscreen wipers • Two-speed windscreen wipers with variable intermittent wipe • Intermittent rear window wash/wipe • Rain-sensitive windscreen wipers	●	●	
Door mirrors • Twin electrically adjustable/heated door mirrors (wide-angle on driver's side) with automatic timed cut-off • Electrically foldable door mirrors	●	●	
Windows • Electrically operated front windows with safety autoreverse and one-touch facility • Heated rear window • Electrically operated rear windows	●	●	
Power tilt and slide glass sunroof with manually operated sunblind	○	○	657
Roof rails, silver-effect	●	●	
EXTERIOR STYLING			
Body styling • Alloy-effect protective front skid plate • Side-protection mouldings • Chrome-effect front grille bar • Body-colour door handles • Body-colour door mirrors • Stainless steel exhaust tailpipe • Stainless steel exhaust tailpipe • Chrome-effect side window trim • Alloy-effect door sill covers • Black B-pillars	●	●	
Windows • Solar heat-absorbing windscreen • Tinted windows • Dark-tinted rear windows	●	●	
	○	●	350

Prices effective as of 31.8.18. Prices are subject to alteration without notice or obligation. ● = Standard equipment. ○ = Optional at extra cost.

MOKKA X FEATURES / OPTIONS



EXTERIOR COLOURS		SC	Elite	Prices including taxes (€)
	Aegean Blue <ul style="list-style-type: none"> • Solid paint • Not available with Morello Red trim 	●	●	
	Summit White <ul style="list-style-type: none"> • Brilliant paint 	○	○	155
	Lava Red <ul style="list-style-type: none"> • Brilliant paint • Not available with Morello Red trim 	○	○	
	Sovereign Silver <ul style="list-style-type: none"> • Two-coat metallic paint 	○	○	600
	Mineral Black <ul style="list-style-type: none"> • Two-coat metallic paint 	○	○	
	Satin Steel Grey <ul style="list-style-type: none"> • Two-coat metallic paint 	○	○	
	Amber Orange <ul style="list-style-type: none"> • Two-coat Premium paint • Not available with Morello Red trim 	○	○	750
	Velvet Red <ul style="list-style-type: none"> • Two-coat Premium paint 	○	○	
	Darkmoon Blue <ul style="list-style-type: none"> • Two-coat Premium paint 	○	○	
	Abalone White <ul style="list-style-type: none"> • Tri-coat premium paint 	○	○	995

Prices effective as of 31.8.18. Prices are subject to alteration without notice or obligation. ● = Standard equipment. ○ = Optional at extra cost.

The colours reproduced may vary slightly from the actual paint colour. As a result they should be used as a guide only. Your Opel Dealer has a comprehensive display of our paint samples.

MOKKA X FEATURES / OPTIONS

WHEELS AND TYRES

	SC	Elite	Prices including taxes (€)
Steel emergency spare wheel (in lieu of emergency tyre inflation kit)	○	○	153.00
 17-inch silver-effect alloy wheels <ul style="list-style-type: none"> • 215/60 R 17 tyres • Emergency tyre inflation kit (in lieu of spare wheel) 	●		
 18-inch multi-spoke alloy wheels <ul style="list-style-type: none"> • 215/55 R 18 tyres • Emergency tyre inflation kit (in lieu of spare wheel) 		●	
 18-inch diamond-cut bi-colour 10-spoke alloy wheels <ul style="list-style-type: none"> • 215/55 R 18 tyres • Emergency tyre inflation kit (in lieu of spare wheel) 		○	250
 18-inch black 10-spoke alloy wheels <ul style="list-style-type: none"> • 215/55 R 18 tyres • Emergency tyre inflation kit (in lieu of spare wheel) 	○	○	250
 19-inch 5-twin spoke alloy wheels <ul style="list-style-type: none"> • 225/45 R 19 tyres • Emergency tyre inflation kit (in lieu of spare wheel) 	○	○	1005



Prices effective as of 31.8.18. Prices are subject to alteration without notice or obligation. ● = Standard equipment. ○ = Optional at extra cost.

MOKKA X SPECIFICATIONS

PETROL ENGINE

1.4i Turbo (140PS)	
Capacity	1364cc
Maximum power	140PS (103kW) @ 4900-6000rpm
Maximum torque	200Nm (147 lb.ft.) @ 1850-4900rpm
Configuration	4 cylinders, 4 valves per cylinder, double overhead camshafts
Fuel/induction system	Turbocharger with intercooler. Variable Valve Timing. Multi-point sequential fuel injection
Emission compliance	Euro 6d-TEMP (6.2)
Service interval	30,000km or 1 year (whichever occurs sooner)

TYRES RATING

Tyre size	Fuel efficiency group	Wet grip performance	External noise	
			Measured (dB)	Group
215/60 R 17	B-C	B	71	
215/55 R 18	E	B	71	
225/45 R 19	E	A	71	

Tyre rating according to EU Regulation 1222/2009

DIESEL ENGINE

1.6CDTi (136PS)	
Capacity	1598cc
Maximum power	136PS (100kW) @ 3500-4000rpm
Maximum torque	320Nm (236 lb.ft.) @ 2000-2250rpm
Configuration	4 cylinders, 4 valves per cylinder, double overhead camshafts
Fuel/induction system	Variable geometry turbocharger with intercooler. Common rail fuel injection
Emission compliance	Euro 6d-TEMP (6.2) with Diesel Particulate Filter
Service interval	30,000km or 1 year (whichever occurs sooner)

MOKKA X SPECIFICATIONS

PERFORMANCE, FUEL ECONOMY AND EMISSIONS

	Wheel size (inches)	Performance (manufacturer's figures)		Urban driving	Fuel economy litres/100km [#]		CO ₂ emissions g/km [#]
		Maximum speed (km/h)	Acceleration 0-100km/h (sec)		Extra-urban driving	Combined figure	
Petrol models							
1.4i Turbo (140PS) S/S ecoTEC FWD	17	196	9.9	8.0	5.4	6.4	147
1.4i Turbo (140PS) S/S ecoTEC FWD	18/19	196	9.9	8.2	5.6	6.5	150
1.4i Turbo (140PS) S/S FWD auto	17	191	10.7	8.8	5.8	6.9	157
1.4i Turbo (140PS) S/S FWD auto	18/19	191	10.7	8.8	6.0	7.0	162
1.4i Turbo (140PS) S/S 4X4	18/19	187	9.9	9.2	6.1	7.2	167
Diesel models							
1.6CDTi (136PS) S/S ecoTEC FWD	17	190	9.3	5.4	4.5	4.8	127
1.6CDTi (136PS) S/S FWD	18/19	190	9.3	5.5	4.6	5.0	131
1.6CDTi (136PS) FWD auto	17	188	10.3	6.8	4.7	5.5	143
1.6CDTi (136PS) FWD auto	18/19	188	10.3	6.9	4.9	5.7	149
1.6CDTi (136PS) S/S 4X4	18/19	187	9.7	6.2	5.1	5.5	146

* = Correct at time of publication. FWD = Front-wheel drive.

= Fuel consumption data and CO₂ emission data are determined using the Worldwide harmonized Light vehicles Test Procedure (WLTP), and the relevant values are translated back to allow the comparability into NEDC, according to regulations R (EC) No. 715/2007, R (EU) No. 2017/1153 and R (EU) No. 2017/1151. The values do not take into account in particular use and driving conditions, equipment or options and may vary depending on the format of tyres. For more information on WLTP please see <https://www.opel.ie/wltp>

START/STOP TECHNOLOGY

Mokka's Start/Stop system, fitted as standard to all models with a manual gearbox, offers real benefits by improving fuel economy and reducing CO₂ emissions, particularly in town. It does this by automatically stopping the engine when you come to a standstill, and then restarting as you prepare to move off.

Before automatically stopping the engine a number of system checks are carried out to ensure that it is both safe and practical to do so. To ensure safety, the driver must depress the clutch pedal, shift in to neutral, and then release the clutch pedal.

System checks carried out before Auto Stop activates include:

- Start/Stop system is not manually deactivated via the facia button
- Sufficient brake vacuum is available to prevent the car rolling down an incline
- Battery is in good condition and charged

- Outside air temperature and engine temperature are above specified minima
- Electronic climate control (where fitted) is not in maximum heating or maximum cooling mode
- Self-cleaning function of the diesel particulate filter is not active

If all of these conditions are satisfied then the vehicle will Auto Stop.

When you are ready to pull away from standstill, Auto Restart is activated by depressing the clutch pedal.

Whilst at a standstill the vehicle is continually monitored. If necessary, the engine will automatically be restarted. Conditions that would initiate an Auto Restart include:

- Low battery level
- Brake vacuum below specified minimum
- Start/Stop system is manually deactivated
- Stationary for 5.5 minutes

TRANSMISSIONS

Six-speed manual gearbox:

Petrol engines: All models

Diesel engines: All models

Six-speed automatic transmission with Active Select function:

Available at extra cost on 1.4i (140PS) and

1.6CDTi (136PS) front-wheel drive models.

Electronically controlled with adaptive driving function and fuel-saving eco mode. Fluid drive with torque converter, lock-up clutch and Active Select.

Intelligent 4X4

Electronically controlled four-wheel drive with variable torque split between front and rear axles.

- Torque transfer device: When pulling away from standstill, or under acceleration, more power is diverted to the rear wheels for maximum grip
- Electronic limited-slip differential: Fitted to the rear axle, it can transfer up to 50% of the rear axle torque between the rear wheels

STEERING

- Speed-sensitive power-assisted steering
- Turning circle (wall-to-wall): 11.50m (37.7ft)

SUSPENSION

Front: Independent. Lightweight MacPherson struts with gas-pressure dampers and coil springs. Anti-roll bar.

Rear: Torsion beam with coil springs and gas-pressure dampers.

BRAKING AND STABILITY

- Switchable Electronic Stability Programme (ESP)
- Cornering brake control
- Straight line stability control
- Rollover mitigation
- Traction control
- Hill start assist
- Anti-lock Braking System (ABS)
- Emergency brake assist
- Electronic brakeforce distribution
- Adaptive brake lights
- Hazard warning lights

All models

Front ventilated discs: 300mm diameter

Rear discs: 268mm diameter

BODY

- Aerodynamic drag co-efficient: Cd 0.35

FUEL TANK CAPACITY

- 53 litres (11.7 gallons)

MOKKA X SPECIFICATIONS

EXTERIOR DIMENSIONS millimetres (inches)

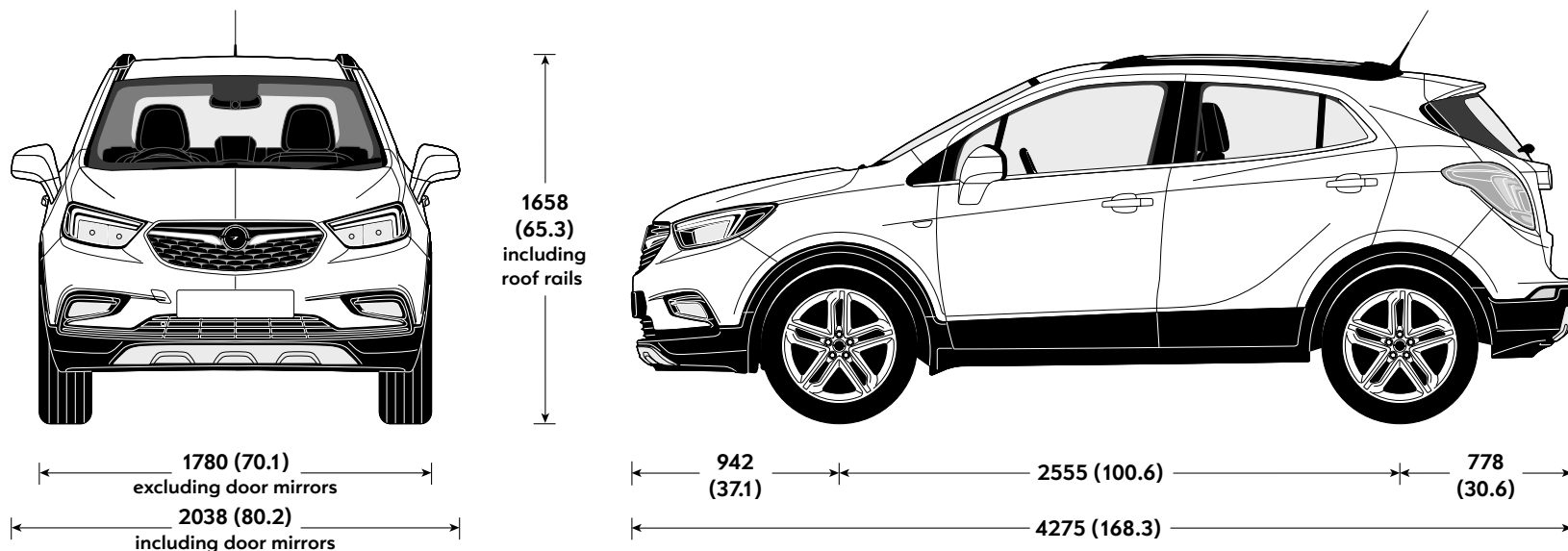

WEIGHTS AND TOWING DATA kg

	Gross vehicle weight	Max. towing weights Trailer with brakes (without brakes)
1.4i Turbo (140PS) ecoTEC FWD	1828	1200 (500)
1.4i Turbo (140PS) FWD automatic	1843	1200 (500)
1.4i Turbo (140PS) 4X4	1879	1200 (500)
1.6CDTi (136PS) FWD manual	1883	1500 (500)
1.6CDTi (136PS) FWD automatic	1896	1500 (500)
1.6CDTi (136PS) 4X4	1938	1500 (500)

FWD = Front-wheel drive.

Gross vehicle weight is the total permissible weight of the vehicle including passengers and their luggage. The **maximum roof rack loading** should not exceed 75kg. The **maximum towing weights** are based on the ability of the car, with two occupants of 75kg each, to restart on a 12% gradient, which is approximately 1 in 8.3, at sea level. At altitudes above 1500 metres, the engine output may drop with a corresponding reduction in towing capability. Any extra weight, such as luggage or additional passengers, should be deducted from the maximum towing weight. With a trailer fully loaded **maximum noseweight** should not exceed 75kg. Always fit Opel towing attachments and accessories available from your Opel Dealer. They are designed specifically for Opel models and carry a 12-month guarantee.

LOADSPACE DIMENSIONS millimetres (inches)

Maximum length (behind rear seats)	731 (28.8)
Maximum length (rear seats folded)	1428 (56.2)
Maximum width	1006 (39.6)
Width between wheel arches	915 (36.0)
Maximum height	808 (31.8)

LOADSPACE CAPACITIES* litres (cu.ft.)

Rear seats up (under luggage compartment cover)	356 (12.6)
Rear seats folded (to upper edge of front seat back)	785 (27.7)
Rear seats folded (to roof)	1305 (46.1)

* = Measured using the ECIE method.