

VIVARO

PRICES AND SPECIFICATIONS

2019 models. Prices effective 31 August 2018



VIVARO PRICES

Trim	Engine	Fuel economy (litres/100km)#					CO ₂ emissions (g/km)#	RRP inc. VAT & VRT €
		Minimum Mass (kg)*	Payload (kg)*	Urban driving	Extra-urban driving	Combined figure		
PANEL VAN								
2700 L1 H1	1.6CDTi (95PS)	1800	1060	7.8	5.8	6.5	170	23,395
2700 L1 H1	1.6CDTi (120PS)	1800	1060	7.8	5.8	6.5	170	24,395
2900 L1 H1	1.6CDTi (95PS)	1800	1220	7.8	5.8	6.5	170	23,895
2900 L1 H1	1.6CDTi (120PS)	1800	1220	7.8	5.8	6.5	170	24,895
2900 L1 H2	1.6CDTi BiTurbo (125PS) S/S ecoTEC	1897	1143	7.3	6.5	6.8	175	26,895
2900 L2 H1	1.6CDTi (95PS)	1825	1265	8.0	6.0	6.7	174	24,395
2900 L2 H1	1.6CDTi (120PS)	1825	1265	8.0	6.0	6.7	174	25,395
2900 L2 H2	1.6CDTi BiTurbo (125PS) S/S ecoTEC	1945	1185	7.4	6.6	6.9	178	27,395
SPORTIVE PANEL VAN								
2900 L1 H1	1.6CDTi (120PS)	1800	1030	7.8	5.8	6.5	170	26,395
2900 L1 H1	1.6CDTi BiTurbo (145PS) S/S	1818	1032	7.1	5.6	6.1	160	27,895
2900 L2 H1	1.6CDTi (120PS)	1825	1235	8.0	6.0	6.7	174	26,895
2900 L2 H1	1.6CDTi BiTurbo (145PS) S/S	1835	1235	7.2	5.8	6.3	164	28,395
LIMITED EDITION NAV PANEL VAN								
2700 L1 H1	1.6CDTi BiTurbo (145PS) S/S	1818	1017	7.1	5.6	6.1	160	28,495
2900 L2 H1	1.6CDTi BiTurbo (145PS) S/S	1835	1220	7.2	5.8	6.3	164	29,495
DOUBLECAB								
2900 L1 H1	1.6CDTi (95PS)	1920	974	8.0	6.0	6.7	174	36,595
2900 L1 H1	1.6CDTi (120PS)	1920	974	8.0	6.0	6.7	174	37,595
2900 L2 H1	1.6CDTi (95PS)	1975	1025	8.0	6.0	6.7	174	37,095
2900 L2 H1	1.6CDTi (120PS)	1975	1025	8.0	6.0	6.7	174	38,095
SPORTIVE DOUBLECAB								
2900 L1 H1	1.6CDTi (120PS)	1920	934	8.0	6.0	6.7	174	39,095
2900 L2 H1	1.6CDTi (120PS)	1975	985	8.0	6.0	6.7	174	39,595
LIMITED EDITION NAV DOUBLECAB								
2900 L1 H1	1.6CDTi BiTurbo (145PS) S/S	1930	919	7.2	5.8	6.3	164	41,495
2900 L2 H1	1.6CDTi BiTurbo (145PS) S/S	1985	970	7.2	5.8	6.3	164	41,995

The above is for information purposes only as our products are continually updated and changes may be made to the specifications at any time. If you require any specific feature, you must consult your authorised Opel Dealer who is regularly updated with any change in specification.

Specifications are subject to change without notice.

RRP does not include recommended delivery charge of €700. This price includes the recommended cost of PDI, number plates and delivery to an Opel Dealer. The recommended delivery charge does not include fuel supplied by the dealer, Motor insurance or any other goods or services supplied by agreement between the Dealer and the customer.

Prices effective 31.08.18. Prices subject to alteration or change without notice or obligation.

* = **Minimum Mass** ('Mass in running order' on Certificate of Conformity and 'Mass in Service' on V5C form) is defined according to European Type Approval and include all fluids, tools, 90% fuel load and driver (75kg). It is minimum mass for this variant and does not consider local specification/trim or deletable options. Weights are also subject to manufacturing tolerances (EU Legislation allows 5% tolerance). Payload figures do not allow for the weight of the driver, or any passenger's, which should therefore be deducted from the figures shown.

= Fuel consumption data and CO₂ emission data are determined using the Worldwide harmonized Light vehicles Test Procedure (WLTP), and the relevant values are translated back to allow the comparability into NEDC, according to regulations R (EC) No. 715/2007, R (EU) No. 2017/1153 and R (EU) No. 2017/1151. The values do not take into account in particular use and driving conditions, equipment or options and may vary depending on the format of tyres. For more information on WLTP please see <https://www.opel.ie/wltp>

VIVARO PRICES

Trim	Engine	Minimum Mass (kg)*	Payload (kg)*	Fuel economy (litres/100km)#			CO ₂ emissions (g/km)#	RRP inc. VAT & VRT €
				Urban driving	Extra-urban driving	Combined figure		
9-SEAT COMBI								
2900 L1 H1	1.6CDTi (120PS) S/S Euro 6c (6.2)	1986	879	7.5	5.3	6.1	161	37,795
2900 L2 H1	1.6CDTi (120PS) S/S Euro 6c (6.2)	2051	874	7.5	5.5	6.2	164	38,295

The above is for information purposes only as our products are continually updated and changes may be made to the specifications at any time. If you require any specific feature, you must consult your authorised Opel Dealer who is regularly updated with any change in specification. Specifications are subject to change without notice.

RRP does not include recommended delivery charge of €700. This price includes the recommended cost of PDI, number plates and delivery to an Opel Dealer. The recommended delivery charge does not include fuel supplied by the dealer, Motor insurance or any other goods or services supplied by agreement between the Dealer and the customer.

Prices effective 31.8.18. Prices subject to alteration or change without notice or obligation.

* = **Minimum Mass** ('Mass in running order' on Certificate of Conformity and 'Mass in Service' on V5C form) is defined according to European Type Approval and include all fluids, tools, 90% fuel load and driver (75kg). It is minimum mass for this variant and does not consider local specification/trim or deletable options. Weights are also subject to manufacturing tolerances (EU Legislation allows 5% tolerance). Payload figures do not allow for the weight of the driver, or any passenger's, which should therefore be deducted from the figures shown.

= Fuel consumption data and CO₂ emission data are determined using the Worldwide harmonized Light vehicles Test Procedure (WLTP), and the relevant values are translated back to allow the comparability into NEDC, according to regulations R (EC) No. 715/2007, R (EU) No. 2017/1153 and R (EU) No. 2017/1151. The values do not take into account in particular use and driving conditions, equipment or options and may vary depending on the format of tyres. For more information on WLTP please see <https://www.opel.ie/wltp>

VIVARO EQUIPMENT / OPTIONS

SAFETY	Vivaro	Sportive	Limited Edition	Combi	RRP inc. Taxes VRT @			
					0%	13.3%	27%	
Airbags:								
Driver's airbag	●	●						
Driver and front passengers' airbag:								
• Front passengers' airbag with deactivation switch Option code: AK5	○	○	○	●	€256	€290	-	
• Driver and front passengers' curtain airbags and driver's side-impact airbag Option code: AWH	○	○	○	○	€300	€340	€395	
• Driver and single front passenger's curtain and side-impact airbags, front passenger's airbag with deactivation switch – Mandates single passenger seat. Option code: AYO	○	○	○	○	€450	€511	€594	
Stability:								
Electronic Stability Programme-plus (ESP-plus) with traction control: – Works in conjunction with the vehicle's electronic braking and engine systems to keep the vehicle stable in many different situations. ESP monitors a variety of inputs to determine when the vehicle starts to lose traction, it can then immediately respond by varying the brake pressure between up to three wheels and adjust the engine output to help correct the loss of traction and improve stability.	●	●	●	●				
Tyre pressure:								
• Tyre pressure monitoring system Option code: UJO	○	○	○	●	€215	€244	-	
Braking:								
Four-channel Anti-lock Braking System (ABS) – Prevents the vehicle's wheels from locking up under heavy braking by momentarily reducing brake pressure at the appropriate wheel, ensuring that you can maintain control of the steering. Emergency brake assist – When emergency braking is detected the vehicle automatically applies the maximum possible braking assistance. Electronic brakeforce distribution – Automatically apportions the optimum braking force to each wheel. Hill start assist – Briefly maintains rear brake pressure to stop the vehicle rolling back on an incline.	●	●	●	●				
Bulkhead:								
• Full-height steel bulkhead without window	●							
• Full-height ABS plastic bulkhead with window – Doublecab only.	●	●	●					
• Full-height steel bulkhead with window Option code: AX9	○				€100	-	-	
FlexCargo load-through bulkhead – Panel Van models only:								
• Dual front passengers' seat with storage, rotating clipboard and fold-flat centre • Load-through bulkhead Option code: AYW	○	●	●		€350	-	-	
• Dual front passengers' seat with storage, rotating clipboard and fold-flat centre • Load-through bulkhead with window Option code: AYW	○				€450	-	-	
• Dual front passengers' seat with storage, rotating clipboard and fold-flat centre • Load-through bulkhead with window Option code: AYW		○	○		€100	-	-	

Prices effective as of 31.8.18. Prices are subject to alteration without notice or obligation. ● = Standard equipment. ○ = Optional at extra cost.

VIVARO EQUIPMENT / OPTIONS

SECURITY	Vivaro	Sportive	Limited Edition	Combi	RRP inc. Taxes VRT @		
					0%	13.3%	27%
Features:	●	●	●	●			
• Electronic engine deadlock immobiliser • Steering column lock • Secure fuel filler flap	●	●	●	●			
• Internal lockable rear and sliding side-access doors • Anti-theft spare wheel cradle	●	●	●	●			
Remote control door locking (features depending on body type):	●	●	●	●			
• Remote control door locking • Two keys with integral remote • Door deadlocks	●	●	●	●			
• Selective door locking • Two three-button keys with integral remote – <i>Only available with one-touch facility for electrically operated windows.</i>	○	●	●	○	€275	€312	€420
Option code: AUX							
• Third key with integral remote	○	○	○	○	€175	€198	€230
Option code: K69							
Keyless entry and start:							
• Keyless entry and start – <i>H1 models only.</i>							
– <i>Start/Stop models. Only available with electronic climate control (all models excluding Combi).</i>							
<i>Adds one-touch facility for electrically operated front-windows.</i>	○	○	○	○	€300	€340	€395
Option code: AVT							
Security alarm system:							
• Engine compartment protection • Ultrasonic detectors in load area • Siren	○	○	○	○	€550	€624	€726
• Thatcham Category 1 approved (TUL3–180/0116) – <i>H1 models only.</i>	○	○	○	○	€550	€624	€726
Option code: XBGY							

Prices effective as of 31.8.18. Prices are subject to alteration without notice or obligation. ● = Standard equipment. ○ = Optional at extra cost.

VIVARO EQUIPMENT / OPTIONS

	Vivaro	Sportive	Limited Edition	Combi	RRP inc. Taxes VRT @		
					0%	13.3%	27%
COMFORT							
Comfort:							
<ul style="list-style-type: none"> • Height-adjustable steering wheel • Leather-covered steering wheel (Sportive / Limited Edition models) • Facia-mounted gear lever • Floor-mounted handbrake lever • Vinyl floor covering • Inertia-reel lap and diagonal seatbelts • Height-adjustable outer front seatbelts 	●	●	●	●			
SEATING							
Driver's seat:							
<ul style="list-style-type: none"> • Height • Reach • Backrest recline • Driver's active safety head restraint • Height-adjustable padded head restraint • Driver's seat armrest 	●	●	●	●			
Dual front passengers' bench seat:							
<ul style="list-style-type: none"> • Fixed position bench seat and backrest • Height-adjustable outer front padded head restraint • Fixed centre seat padded head restraint 	●			●			
Dual front passengers' seat with underseat storage:							
<ul style="list-style-type: none"> • Fixed position bench seat and backrest • Height-adjustable outer front padded head restraint • Fixed centre seat padded head restraint – <i>Doublecab / Combi models.</i> <p style="text-align: right;">Option code: AGE</p>	○	●	●	○	€210	€238	€277
Single front passenger's seat:							
<ul style="list-style-type: none"> • Lumbar adjustment • Height • Reach • Backrest recline • Height-adjustable padded head restraint • Armrest – <i>Sportive / Limited Edition Panel Van models will be supplied with full-height steel bulkhead when this option is specified.</i> <p style="text-align: right;">Option code: AGD</p>	○	○	○	○	€210	€238	€277
Heated front seats:							
<ul style="list-style-type: none"> • Electrically heated driver and single front passenger seats – <i>Only available with either single front passenger seat and curtain airbags / side-impact airbag options.</i> <p style="text-align: right;">Option code: KA1</p>	○	○	○	○	€250	€283	€330
Seat trim:							
<ul style="list-style-type: none"> • Blue Tricess cloth seat trim • Black Connect embossed cloth seat trim 	●			●			
<ul style="list-style-type: none"> • Eco-Leather seat trim – 1.25mm thick Microfibre featuring improved anti-tear / scratch, acid / alkali and light resistance, making it a better choice for the environment of a commercial vehicle. • Driver and single front passenger seat (2 seats) – <i>Panel Van.</i> – <i>Only available when single front passenger seat is specified.</i> <p style="text-align: right;">Option code: XiEQ</p>		○	○		€750	–	–
<ul style="list-style-type: none"> • Eco-Leather seat trim – 1.25mm thick Microfibre featuring improved anti-tear / scratch, acid / alkali and light resistance, making it a better choice for the environment of a commercial vehicle. • Driver and dual front passenger bench seat (3 seats) – <i>Panel Van.</i> <p style="text-align: right;">Option code: XiER</p>		○	○		€995	–	–
<ul style="list-style-type: none"> • Eco-Leather seat trim – 1.25mm thick Microfibre featuring improved anti-tear / scratch, acid / alkali and light resistance, making it a better choice for the environment of a commercial vehicle. • Driver, single front passenger and rear bench seat (5 seats) – <i>Doublecab.</i> – <i>Only available when single front passenger seat is specified.</i> <p style="text-align: right;">Option code: XiES</p>		○	○		–	€1500	–
<ul style="list-style-type: none"> • Eco-Leather seat trim – 1.25mm thick Microfibre featuring improved anti-tear / scratch, acid / alkali and light resistance, making it a better choice for the environment of a commercial vehicle. • Driver, dual front passenger and rear bench seat (6 seats) – <i>Doublecab.</i> <p style="text-align: right;">Option code: XiET</p>		○	○		–	€1800	–

Prices effective as of 31.8.18. Prices are subject to alteration without notice or obligation. ● = Standard equipment. ○ = Optional at extra cost.

VIVARO EQUIPMENT / OPTIONS

	Vivaro	Sportive	Limited Edition	Combi	RRP inc. Taxes VRT @		
					0%	13.3%	27%
REAR SEATING							
Doublecab second-row seating:							
• Three-individually contoured rear seats • Inertia-reel lap and diagonal seatbelts	●	●	●				
• Padded head restraints							
• Underseat storage • 12-volt accessory socket		●	●				
Combi second-row seating:							
• Three-passenger removable bench seat				●			
• 60/40 split-folding seat back for easier access to third-row bench seat							
• Height-adjustable padded head restraints • Inertia-reel lap and diagonal seatbelts							
Combi third-row seating:							
• Three-passenger bench seat • Height-adjustable padded head restraints				●			
• Fold and tumble feature for creating extra load area without removing seats							
• Removable rear seats • Inertia-reel lap and diagonal seatbelts • Armrests							
CABIN STORAGE							
Accessory sockets:							
• Facia-mounted 12-volt accessory socket	●	●	●	●			
Facia storage:							
• Nine facia storage spaces offering more than 24 litres of storage	●	●	●	●			
• Storage compartment with lid above glovebox							
• Illuminated glovebox • Three drinks holders • Coin holder							
Front door pockets:							
• Large door pockets with drinks holder	●	●	●	●			

Prices effective as of 31.8.18. Prices are subject to alteration without notice or obligation. ● = Standard equipment.

VIVARO EQUIPMENT / OPTIONS

DRIVER ASSISTANCE	Vivaro	Sportive	Limited Edition	Combi	RRP inc. Taxes VRT @		
					0%	13.3%	27%
Windscreen wipers: • Two-speed windscreen wipers • Variable intermittent wipe • Electric screenwash	●	●	●	●			
Multi-function trip computer: • Trip odometer • Vehicle range based on remaining fuel • Average speed • Average fuel economy • Instantaneous fuel economy • Driving time	●	●	●	●			
Parking assistance: • Rear parking distance sensors Option code: UD7	○	●	●	○	€431	€489	€569
• Rear-view camera – H1 models only. – Requires Sight and Light Pack (Sportive models). Option code: UDS		○	○		€350	€397	–
• Rear-view camera • Rear parking distance sensors – H1 models only. – Requires Lighting Pack / Sight and Light Pack. Option code: UDS	○			○	€584	€663	€771
• Nearside blind-spot / junction mirror located in front passenger sunvisor	●	●	●	●			
Cruise control, speed limiter Option code: K34	○	●	●	○	€178	€201	€234
Speed limiter – These are factory-fitted speed limiters that cannot be adjusted by driver: • Choice of three speeds: 90km/h / 100km/h / 110km/h Option code: KYJ (90km/h) Option code: KYK (100km/h) Option code: KYL (110km/h)	○	○	○	○	€119	€135	€156

Prices effective as of 31.8.18. Prices are subject to alteration without notice or obligation. ● = Standard equipment. ○ = Optional at extra cost.

VIVARO EQUIPMENT / OPTIONS

	Vivaro	Sportive	Limited Edition	Combi	RRP inc. Taxes VRT @		
					0%	13.3%	27%
DRIVER INFORMATION							
Instrumentation: • Speedometer • Rev counter • Fuel gauge with low fuel warning light • Fuel economy gauge • Coolant temperature warning light	●	●	●	●			
ECO features: • Shift-up indicator – Indicates when to change gear for optimum fuel economy.	●	●	●	●			
Driver information display: • Monochrome display located in instrument cluster • Odometer • Service-due indicator • Displays trip computer data	●	●	●	●			
Central fascia display: • Audio information • Digital clock with automatic RDS time adjustment • Outside air temperature with ice warning function • Additional features and location dependent on infotainment unit (see Audio, Communication and Navigation for details)	●	●	●	●			
Warning indicators: • Low oil level, low brake fluid, brake pad wear, battery, fuel filter, low AdBlue® level, seatbelt warning and doors open	●	●	●	●			
Digital tachograph: • Digital tachograph only available with R 16 audio unit – <i>Important: The digital tachograph must be specified at time of ordering as it cannot be fitted retrospectively. Option price does not include calibration which must be carried out at an approved tachograph centre within 14 days of the vehicle's registration. Please note: The legislation regarding the use of tachographs is complex and operators should seek independent advice or speak to the Commercial Vehicle specialist at your Opel Dealer to ensure compliance. Alternatively your local transport office will also be able to provide clarification of the relevant legislation.</i> Option code: TGP	○			○	€615	€698	€811
PACKS							
Navigation Pack: • Satellite navigation – NAVI 50 IntelliLink. • Rear parking distance sensors • Rear-view camera • One-touch electrically operated front windows • Three-button key • Selective door locking – H1 models only. Not available on Platform Cab models. Requires Lighting Pack / Sight and Light Pack. Option code: OEC	○			○	€1565	€1777	€2020
Navigation Pack: • Satellite navigation – NAVI 50 IntelliLink. • Rear-view camera – Requires Sight and Light Pack. Option code: OEC		○			€1365	€1550	–

Prices effective as of 31.8.18. Prices are subject to alteration without notice or obligation. ● = Standard equipment. ○ = Optional at extra cost.

VIVARO EQUIPMENT / OPTIONS

INFOTAINMENT	Vivaro	Sportive	Limited Edition	Combi	RRP inc. Taxes VRT @		
					0%	13.3%	27%
R 16 BT USB: Onboard features: • DAB digital radio • AM/FM stereo radio with 6-station presets • RDS with Traffic Programme • Two speakers – <i>Four on Combi models.</i> • 20 watts per channel output Media connections: • USB connection with iPod control • Aux-in socket • Bluetooth® audio streaming (A2DP Profile) Mobile phone portal: • Bluetooth® connectivity • Handsfree calls via steering wheel controls • Vehicle microphone • Phone book access – <i>Contacts / last calls / missed calls etc.</i> <i>(features dependent on mobile phone).</i>	●	N/C	N/C	●			
CD 18 BT USB: Onboard features: • DAB digital radio • AM/FM stereo radio with 6-station presets • CD/MP3 CD player • RDS with Traffic Programme • Two Speakers – <i>Four on Combi models</i> • 20 watts per channel output Media connections: • USB connection with iPod control • Aux-in socket • Bluetooth® audio streaming (A2DP Profile) Mobile phone portal: • Bluetooth® connectivity • Handsfree calls via steering wheel controls • Vehicle microphone • Phone book access – <i>Contacts / last calls / missed calls etc.</i> <i>(features dependent on mobile phone).</i>		●					
NAVI 50 IntelliLink – Not available when tachograph is specified: Onboard features: • DAB digital radio • AM/FM stereo radio with 18-station presets • 7-inch facia-mounted colour touchscreen • RDS with Traffic Programme • Two speakers – <i>Four on Combi models.</i> • 20 watts per channel output Navigation features: • Satellite navigation system • 3D street level mapping • Major route mapping for Western Europe Media connections: • USB connection with iPod control • Aux-in socket • Bluetooth® audio streaming (A2DP Profile) • Siri voice control Mobile phone portal: • Bluetooth® connectivity • Handsfree calls via steering wheel controls • Vehicle microphone • Phone book access – <i>Contacts / last calls / missed calls etc. are mirrored on the display and are easily navigated using the touchscreen (features dependent on mobile phone).</i>	○	○	●	○	€780	€885	€1030
NAVI 80 IntelliLink – Only available in conjunction with cruise control. Not available when tachograph is specified: Onboard features: • DAB digital radio • AM/FM stereo radio with 18-station presets • 7-inch facia-mounted colour touchscreen • RDS with Traffic Programme • Two speakers – <i>Four on Combi models.</i> • 20 watts per channel output Navigation features: • Satellite navigation system • TomTom LIVE services (inclusive subscription for TomTom LIVE ends 31 December 2020, and cannot be renewed) • 3D street level mapping • Major route mapping for Europe • Traffic Information Media connections: • USB connection with iPod control • Aux-in socket • Bluetooth® audio streaming (A2DP Profile) • Integrated voice control Mobile phone portal: • Bluetooth® connectivity • Handsfree calls via steering wheel controls • Vehicle microphone • Phone book access – <i>Contacts / last calls / missed calls etc. are mirrored on the display and are easily navigated using the touchscreen (features dependent on mobile phone).</i>	○	○	○	○	€1440	€1635	€1901

Prices effective as of 31.8.18. Prices are subject to alteration without notice or obligation. ● = Standard equipment. ○ = Optional at extra cost.

VIVARO EQUIPMENT / OPTIONS

	Vivaro	Sportive	Limited Edition	Combi	RRP inc. Taxes VRT @		
					0%	13.3%	27%
INFOTAINMENT							
Flexdock for smartphone / tablet:							
• Universal smartphone docking station (up to 4.7-inch) Option code: UV8	○	○	●	○	€35	€39	€45
• Tablet docking station (up to 4.8 – 10.6 inch) – Only available with R 16 audio unit. Option code: B8L	○			○	€200	€226	€263
Additional features:							
• Steering column mounted audio controls • Flexible roof-mounted aerial	●	●	●	●			
HEATING AND VENTILATION							
Cab heating:							
• Four-speed fan • Illuminated controls • Four adjustable facia vents • Windscreen demist vents • Side window demist vents	●	●	●	●			
Climate and Cruise Pack:							
• Air conditioning with air recirculation facility (cab only) • CD 18 BT USB audio unit • Cruise control Option code: XAEB	○			○	€925	€1050	€1221
Air conditioning – Cab only:							
• Air recirculation facility • Pollen filter • Illuminated controls • Chilled glovebox facility Option code: C60	○	●	●	○	€1224	€1390	€1616
Electronic climate control:							
• Incorporating air conditioning • LCD temperature display • Automatic air direction and fan speed with manual override • Illuminated controls • Pollen filter • Chilled glovebox facility – Requires Lighting Pack. Option code: C68	○				€1574	€1787	–
Electronic climate control:							
• LCD temperature display • Automatic air direction and fan speed with manual override • Illuminated controls • Pollen filter • Chilled glovebox facility – Requires Sight and Light Pack. Option code: C68		○	○		€350	€397	–
Air conditioning – Cab and saloon:							
• Air recirculation facility • Pollen filter • Illuminated controls • Chilled glovebox facility • Auxiliary heating ducts Option code: CJ5				○	–	–	€2436

Prices effective as of 31.8.18. Prices are subject to alteration without notice or obligation. ● = Standard equipment. ○ = Optional at extra cost.

Please note: The air conditioning in vehicles with N1 type approval relies upon fluorinated greenhouse gases (R134a) for its functioning. The front system contains a quantity of overall 580g of R 134a, which corresponds to a CO₂ equivalent of 0.83 tons. The front and rear system contains a quantity of overall 890g of R 134a, which corresponds to a CO₂ equivalent of 1.27 tons. The global warming potential amounts to 1430. Information acc. to R (EU) No. 517/2014.

VIVARO EQUIPMENT / OPTIONS

					RRP inc. Taxes VRT @		
	Vivaro	Sportive	Limited Edition	Combi	0%	13.3%	27%
LOAD ACCESS							
Illuminated load / saloon area	●	●	●	●			
Nearside access – Panel Van only:							
Nearside side-access door:	●	●	●				
• Nearside sliding side-access door • Unglazed							
Offside access – Panel Van only:							
Offside side-access door:	○	○	○		€395	-	-
• Offside sliding side-access door • Unglazed							
Option code: BSJ							
Nearside and offside access:							
Side-access doors with fixed windows – <i>Standard on Doublecab:</i>							
• Fixed window to standard nearside side-access door	○	○	○	●	€550	-	-
• Offside side-access door • Fixed window to offside side-access door							
Option code: BSB							
Side-access doors with sliding windows – <i>Panel Van models. Only available with glazed rear doors / tailgate:</i>							
• Sliding window to standard nearside side-access door	○	○	○		€625	-	-
• Offside side-access door • Sliding window to offside side-access door							
Option code: BSC							
Side-access doors with sliding windows							
• Sliding window to standard glazed nearside side-access door	○	○	○	○	-	€709	€825
• Sliding window to standard glazed offside side-access door							
Option code: BSC							
Rear access:							
Rear solid doors:	●	●	●				
• Twin rear doors • 90°/180° opening							
• Twin rear doors • 270° opening – <i>Not available on L1 models.</i>	○	○	○		€350	€397	-
Option code: 7U4							
Rear glazed doors:							
• Glazed rear doors • 90°/180° opening – <i>Only available with glazed bulkhead options.</i>	○	○	○	○	€100	€113	€131
Option code: J1X							
• Glazed tailgate – <i>Not available on H2 models. Only with glazed bulkhead and heated rear windows with wash/wipe facility options.</i>	○	○	○	●	€173	€196	-
Option code: J1U							
• Heated rear windows with wash/wipe facility – <i>Only with glazed rear door and tailgate options.</i>	○	○	○	●	€195	€221	-
Option code: C25							
LOAD RESTRAINT							
Load anchorage:	●	●	●				
• Fixed floor-mounted load restraint lashing eyes							
Load lining:							
• Full-height coated wooden load lining panels – <i>H1 only.</i>	○	○	○		€425	€482	-
Option code: ERK							
• Full-height lightweight plastic honeycomb load lining panels – <i>H1 only.</i>	○	○	○		€425	€482	-
Option code: B6H							
• Resin-coated laminate plywood load floor covering – <i>H1 only.</i>	○	○	○		€425	€482	-
Option code: B68							
• Resin-coated laminate plywood wheel arch protection – <i>H1 only.</i>	○	○	○		€300	€340	-
Option code: B65							





Prices effective as of 31.8.18. Prices are subject to alteration without notice or obligation. ● = Standard equipment. ○ = Optional at extra cost.

VIVARO EQUIPMENT / OPTIONS

	Vivaro	Sportive	Limited Edition	Combi	RRP inc. Taxes VRT @		
					0%	13.3%	27%
EXTERIOR CONVENIENCE / STYLING							
Exterior features: • Unique styled graphics – Black or silver dependent on exterior colour. Please see Exterior Colours page.			●				
Appearance Pack One: • Body-colour front bumper • Body-colour rear quarter bumpers – H2 models are only available when Glacier White or Platinum Silver colours are specified. Option code: 5LK	○	●		○	€400	€454	€527
Appearance Pack - Sportive: • Body-colour front bumper • Chrome-effect front grille • Body-colour rear and rear quarter bumpers • Body-colour side-protection mouldings • Body-colour mirror housings and sliding door rail cover • Body-colour D pillar and light surrounds Option code: 5LS		○	●		€1000	€1135	–
Windows: • Electrically operated front windows	●	●	●	●			
• One-touch facility for electrically operated windows Option code: AXG	○	●	●	○	€60	€68	€79
• Dark-tinted rear glazing – H1 models only. Only available with glazed rear doors / tailgate with heated windows and wash / wipe facility. Option code: AJS	○	○	○	○	€298	€338	€393
Door mirrors: • Foldable electrically adjustable/heated door mirrors • Wide-angle mirror on driver's side	●	●	●	●			
Paint finish: • Special paint – Restrictions apply, please consult your Dealer for details.	○			○	At extra cost		
EXTERIOR LIGHTING							
Standard lighting: • Lights-on audible warning • Electric headlight beam levelling • Twin reversing lights • Hazard warning lights • Rear fog lights • High-level brake light • High-level tail lights • Side-repeat indicators • Daytime running lights – LED on Sportive / Limited Edition models. • Front fog lights – Chrome surround on Limited Edition models. Option code: T3U	●	●	●	●	○	●	○
	○	●	●	○	€200	€227	€263
Lighting Pack: • Static cornering lights • Front fog lights • Automatic lighting control • Rain-sensitive windscreen wipers • Door-to-door illumination Option code: XAEG	○			○	€395	€448	€521
Sight and Light Pack: • Automatic lighting control • Rain-sensitive windscreen wipers Option code: 5BT		○	●		€350	€397	€461

Prices effective as of 31.8.18. Prices are subject to alteration without notice or obligation. ● = Standard equipment. ○ = Optional at extra cost.







VIVARO EQUIPMENT / OPTIONS

EXTERIOR COLOURS					RRP inc. Taxes VRT @					
					Vivaro	Sportive	Limited Edition	Combi	0%	13.3%
	Glacier White (10U) <ul style="list-style-type: none"> • Solid paint • Black alloy wheels / graphics on Limited Edition models 									
	Flame Red (79U / 79Z) <ul style="list-style-type: none"> • Brilliant paint • Black or silver alloy wheels / graphics on Limited Edition models 		Iron Grey (10D) <ul style="list-style-type: none"> • Brilliant paint • Silver alloy wheels / graphics on Limited Edition models 							
	Spring Green (10G / 10Z) <ul style="list-style-type: none"> • Brilliant paint • Black alloy wheels / graphics on Limited Edition models 									
				○	N/C	N/C	○	€155	€175	€204

Prices effective as of 31.8.18. Prices are subject to alteration without notice or obligation. ● = Standard equipment. ○ = Optional at extra cost. N/C = No-cost option.

The colours reproduced may vary slightly from the actual paint colour. As a result they should be used as a guide only. Your Opel Dealer has a comprehensive display of our paint samples.





VIVARO EQUIPMENT / OPTIONS

EXTERIOR COLOURS							RRP inc. Taxes VRT @			
				Vivaro	Sportive	Limited Edition	Combi	0%	13.3%	27%
	Panorama Blue (4UU) • Two-coat metallic paint • Silver alloy wheels / graphics on Limited Edition models		Midnight Black (92U) • Two-coat metallic paint • Silver alloy wheels / graphics on Limited Edition models							
	Cassiopeia Silver (10J) • Two-coat metallic paint • Silver alloy wheels / graphics on Limited Edition models		Copper Brown (10K) • Two-coat metallic paint • Silver alloy wheels / graphics on Limited Edition models	○	N/C	N/C	○	€685	€777	€904
	Jasper Brown (10E) • Two-coat metallic paint • Silver alloy wheels / graphics on Limited Edition models		Platinum Silver (10H) • Two-coat metallic paint • Black alloy wheels / graphics on Limited Edition models							

Prices effective as of 31.8.18. Prices are subject to alteration without notice or obligation. ○ = Optional at extra cost. N/C = No-cost option.

The colours reproduced may vary slightly from the actual paint colour. As a result they should be used as a guide only. Your Opel Dealer has a comprehensive display of our paint samples.

VIVARO EQUIPMENT / OPTIONS

					RRP inc. Taxes VRT @			
WHEELS AND TYRES		Vivaro	Sportive	Limited Edition	Combi	0%	13.3%	27%
	16-inch steel wheels with centre cap: <ul style="list-style-type: none"> • 205/65 R 16 tyres (1.6CDTi 95/120/125PS engines) • 215/65 R 16 tyres (1.6CDTi 145PS engines) • Full-size spare wheel 	●						
	16-inch steel wheels with wheel trims: <ul style="list-style-type: none"> • 205/65 R 16 tyres (1.6CDTi 95/120/125PS engines) • 215/65 R 16 tyres (1.6CDTi 145PS engines) • Full-size spare wheel 		●		●			
	17-inch black alloy wheels: <ul style="list-style-type: none"> • 215/60 R 17 tyres • 16-inch steel spare wheel – On Limited Edition models, wheel finish dependent on body colour. Please see Exterior Colours page. 			●				
	17-inch silver alloy wheels: <ul style="list-style-type: none"> • 215/60 R 17 tyres • 16-inch steel spare wheel – Not available on H2 models. – On Limited Edition models, wheel finish dependent on body colour. Please see Exterior Colours page. 	○	○	●		€1845	€2095	€2436
	Option code: RS6							
All-season tyres:		○	○			€155	€175	€204
• 205/65 R 16 (All engines)	Option code: NRK							
Tyre inflation kit in lieu of spare wheel – Not available on L2 Combi models.	Option code: WTC	N/C	N/C	N/C	N/C	No-cost option		

Prices effective as of 31.8.18. Prices are subject to alteration without notice or obligation. ● = Standard equipment. ○ = Optional at extra cost. N/C = No-cost option.

VIVARO EQUIPMENT / OPTIONS

MECHANICAL	Vivaro	Sportive	Limited Edition	Combi	RRP inc. Taxes VRT @		
					0%	13.3%	27%
Transmission: Six-speed manual gearbox: • Front-wheel drive • Transverse engine/gearbox	●	●	●	●			
Steering: • Hydraulic power-assisted rack and pinion system • Energy absorbing steering column Turning circles Kerb-to-kerb FWD L1 11.8m (38.7ft.) FWD L2 13.2m (43.3ft.)	●	●	●	●			
Brakes: Front ventilated disc brakes: • 296mm x 28mm Rear disc brakes: • 280mm x 12mm	●	●	●	●			
Power take-off • Engine driven power take-off • Six-pin / two-pin connector for conversions Option code: V66 Option code: KPD	○	○	○		€206	€233	–
Fuel tank: • 80 litres (17.6 gallons) capacity	●	●	●	●			
AdBlue® tank: • 22 litres (4.8 gallons) capacity	●	●	●	●			
Towing: • Tow bar with 13-pin electrics • Trailer stability programme – Does not suit trailers with LED lights. For trailers with LED lights use genuine Opel Accessory tow bars which also include trailer stability programme. Unless specific exemptions apply, vehicles operated with a trailer, where the combined weight of the vehicle, trailer and payload exceeds 3500kg, require a digital tachograph. Option code: VR2	○	○	○	○	€512	€581	€675
Electrical: • 80Ah maintenance-free battery (70Ah on air conditioned models) • 185A alternator (150A on air conditioned models)	●	●	●	●			
CANbus interface: Allows the vehicle's electrical systems to integrate with additional equipment. Option code: KC6	○	○	○	○	€180	€204	€237
Six-pin / two pin electrical connector for conversions Option code: KPD	○	○	○	○	€85	€96	€111
Front suspension: • MacPherson type • Independent double wishbones • Coil springs • Gas-pressure dampers	●	●	●	●			
Rear suspension: • Independent four-link, progressive-rate mini-block springs • Gas-pressure dampers	●	●	●	●			

Prices effective as of 31.8.18. Prices are subject to alteration without notice or obligation. ● = Standard equipment. ○ = Optional at extra cost.

VIVARO SPECIFICATIONS



DIESEL ENGINES

	1.6CDTi (95PS) BlueInjection with or without Start/Stop	1.6CDTi (120PS) BlueInjection
Capacity	1598cc	1598cc
Maximum power	95PS (70kW) @ 3500rpm	120PS (89kW) @ 3500rpm
Maximum torque	260Nm (192 lb.ft.) @ 1500rpm	300Nm (221 lb.ft.) @ 1750rpm
Configuration	4 cylinders, 4 valves per cylinder, double overhead camshafts	
Fuel/induction system	Variable geometry turbocharger with intercooler. Common rail fuel injection	
Emission compliance	Euro 6b (6.1)	Euro 6c (6.2)
Service interval	40,000km or two-years (whichever occurs sooner)	

	1.6CDTi BiTurbo (125PS) ecoTEC BlueInjection Start/Stop	1.6CDTi BiTurbo (145PS) BlueInjection Start/Stop
Capacity	1598cc	1598cc
Maximum power	125PS (92kW) @ 3500rpm	145PS (107kW) @ 3500rpm
Maximum torque	320Nm (236 lb.ft.) @ 1500rpm	340Nm (251 lb.ft.) @ 1750rpm
Configuration	4 cylinders, 4 valves per cylinder, double overhead camshafts	
Fuel/induction system	Twin variable geometry turbochargers with intercoolers. Common rail fuel injection	
Emission compliance	Euro 6b (6.1)	Euro 6b (6.1)
Service interval	40,000km or two-years (whichever occurs sooner)	

* = Please note: Vehicles with BlueInjection technology will need regular AdBlue® top-ups also between servicing requirements. An indicator integrated into the onboard computer will warn you when you need to top up. More information under www.opel.ie. In accordance with regulations R (EC) No. 715/2007 and R (EC) No. 692/2008 (in the versions respectively applicable).

TYRE RATINGS

Tyre size	Fuel efficiency group	Wet grip performance	External noise	
			Measured (dB)	Group
205/65 R 16	C-E	B-E	71-72	
215/65 R 16	C	B	70	
215/60 R 17	C	B	70	

Tyre rating according to EU Regulation 1222/2009

VIVARO PANEL VAN SPECIFICATIONS

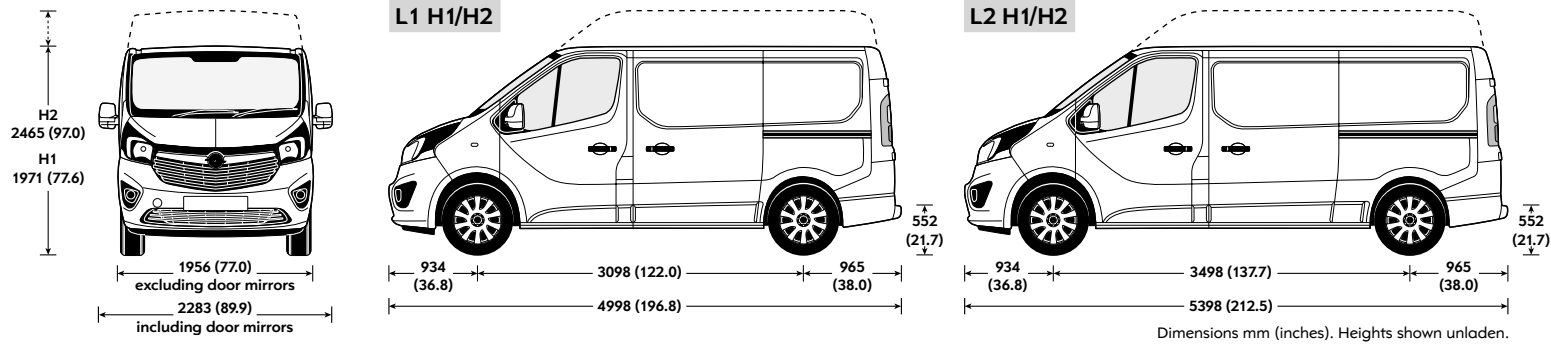

LOADSPACE DIMENSIONS MM (INCHES) – PANEL VAN

	L1	L2
Maximum length at load floor	2537 (99.9)	2937 (115.6)
Maximum length with load-through facility maximum length to seat – <i>Approximate</i> .	2967 (116.8)	3367 (132.5)
Maximum length with load-through facility maximum length to front footwell – <i>Approximate</i> .	3750 (147.6)	4150 (163.4)
Maximum width	1662 (65.5)	1662 (65.5)
Width between wheel arches	1268 (49.9)	1268 (49.9)
Maximum height - H1	1387 (54.6)	1387 (54.6)
Maximum height - H2	1898 (74.7)	1898 (74.7)

LOADSPACE ACCESS MM (INCHES) – PANEL VAN

	L1	L2
Side door aperture height	1284 (50.5)	1284 (50.5)
Side door aperture width	1030 (40.5)	1030 (40.5)
Rear door aperture height – H1	1320 (52.0)	1320 (52.0)
Rear door aperture height – H2	1820 (71.6)	1820 (71.6)
Rear door aperture width	1391 (54.8)	1391 (54.8)
Loading height (unladen)	552 (21.7)	552 (21.7)

PLATED WEIGHTS AND TOWING DATA KG – PANEL VAN

Model	Gross Vehicle Weights (GVW)	Plated weights		Towing weights		Plated Gross Combination Weights (GCW)	
		Front axle	Rear axle	Braked	Unbraked		
L1 H1/H2 Panel Van	2700	2800	1585	1650	2000	750	4800
	2700 BiTurbo	2820	1585	1650	2000	750	4820
	2900	2960	1585	1650	2000	750	4960
	2900 BiTurbo	2980	1585	1650	2000	750	4980
L2 H1 Panel Van	2900	3030	1585	1650	2000	750	5030
	2900 BiTurbo	3040	1585	1650	2000	750	5040
L2 H2 Panel Van	2900 BiTurbo	3070	1585	1650	2000	750	5070

Gross plated weights (including axle weights) quoted on the vehicle plate are to UK plated weight specification and must never be exceeded. For further information please see Glossary of Terms.

LOADSPACE VOLUMES CU.M (CU.FT.) – PANEL VAN

	L1	L2
H1 Panel Van	5.2 (183.6)	6.0 (211.9)
H2 Panel Van	7.2 (254.3)	8.6 (303.7)

VIVARO DOUBLECAB SPECIFICATIONS

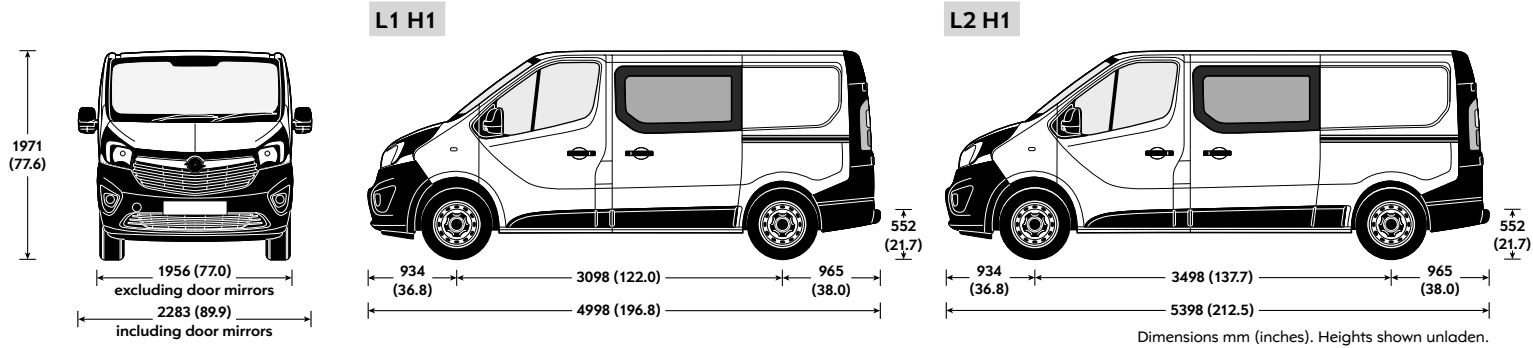

LOADSPACE DIMENSIONS MM (INCHES) – DOUBLECAB

	L1	L2
Maximum length at load floor	2023 (79.6)	2423 (95.4)
Maximum length behind rear seats	1340 (42.7)	1740 (68.5)
Maximum width	1662 (65.5)	1662 (65.5)
Width between wheel arches	1268 (49.9)	1268 (49.9)
Maximum height	1387 (54.6)	1387 (54.6)

LOADSPACE ACCESS MM (INCHES) – DOUBLECAB

	L1	L2
Side door aperture height	1284 (50.5)	1284 (50.5)
Side door aperture width	1030 (40.5)	1030 (40.5)
Rear door aperture height	1320 (52.0)	1320 (52.0)
Rear door aperture width	1391 (54.8)	1391 (54.8)
Loading height (unladen)	552 (21.7)	552 (21.7)

LOADSPACE VOLUMES CU.M (CU.FT.) – DOUBLECAB

	L1	L2
Doublecab	3.2 (113.0)	4.0 (141.3)

L1

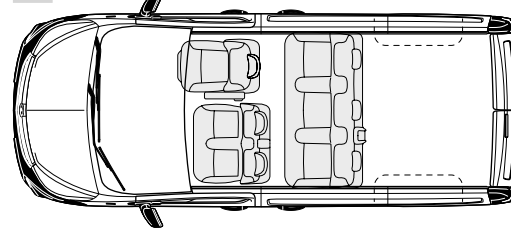

L2

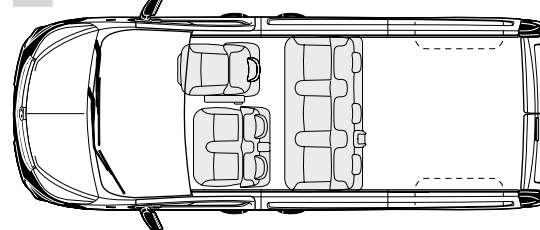

PLATED WEIGHTS AND TOWING DATA KG – DOUBLECAB

Model		Gross Vehicle Weights (GVW)	Plated weights		Towing weights		Plated Gross Combination Weights (GCW)
			Front axle	Rear axle	Braked	Unbraked	
L1 H1 Doublecab	2900	2834	1585	1650	2000	750	4834
	2900 BiTurbo	2844	1585	1650	2000	750	4844
L2 H1 Doublecab	2900	2940	1585	1650	2000	750	4940
	2900 BiTurbo	2950	1585	1650	2000	750	4950

Gross plated weights (including axle weights) quoted on the vehicle plate are to UK plated weight specification and must never be exceeded. For further information please see Glossary of Terms.

VIVARO COMBI SPECIFICATIONS

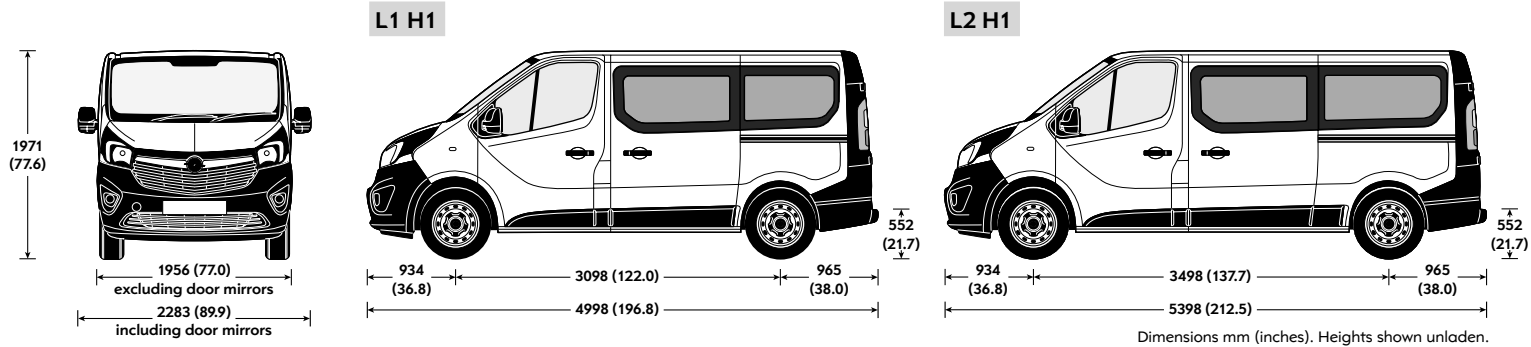

LOADSPACE DIMENSIONS MM (INCHES) – COMBI

	L1	L2
Maximum length behind rear seats	736 (30.0)	1136 (44.7)
Maximum width	1662 (65.5)	1662 (65.5)
Width between wheel arches	1268 (49.9)	1268 (49.9)
Maximum height	1369 (53.9)	1369 (53.9)

LOADSPACE ACCESS MM (INCHES) – COMBI

	L1	L2
Side door aperture height	1284 (50.5)	1284 (50.5)
Side door aperture width	1030 (40.5)	1030 (40.5)
Rear door aperture height	1320 (52.0)	1320 (52.0)
Rear door aperture width (at floor)	1391 (54.8)	1391 (54.8)
Loading height (unladen)	552 (21.7)	552 (21.7)

LOADSPACE VOLUMES CU.M (CU.FT.) – COMBI

	L1	L2
Combi	1.0 (35.3)	1.8 (63.6)
Combi – third-row seats down	2.1 (74.2)	2.9 (102.4)
Combi – third-row seats removed	3.2 (113.0)	4.0 (141.3)

L1

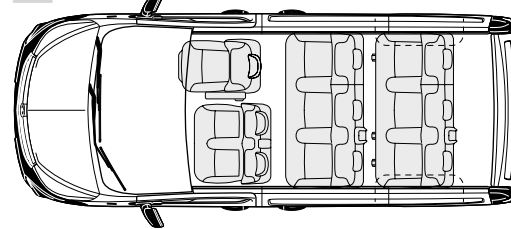

L2

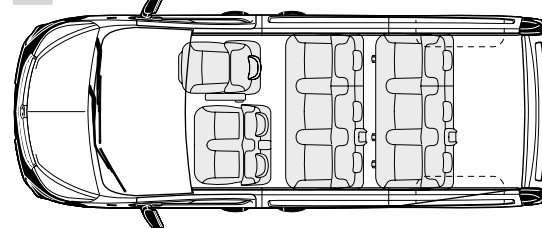

PLATED WEIGHTS AND TOWING DATA KG – COMBI

Model	Gross Vehicle Weights (GVW)	Plated weights		Towing weights		Plated Gross Combination Weights (GCW)	
		Front axle	Rear axle	Braked	Unbraked		
L1 H1 Combi	2900	2925	1585	1650	2000	750	4925
L2 H1 Combi	2900	3010	1585	1650	2000	750	5010

Gross plated weights (including axle weights) quoted on the vehicle plate are to UK plated weight specification and must never be exceeded. For further information please see Glossary of Terms.

VIVARO GLOSSARY OF TERMS

PLATED WEIGHT

The maximum weight to which a vehicle or an axle may be loaded, determined either by the design of the components or by legislation. All commercial vehicles must carry a manufacturer's 'plate' showing the vehicle and axle gross 'plated weights'. It is an offence to drive a vehicle in a condition where any of these weights are exceeded.

MINIMUM MASS

Minimum Mass ('Mass in running order' on Certificate of Conformity and 'Mass in Service' on V5C form) is defined according to European Type Approval and include all fluids, tools, 90% fuel load and driver (75kg). It is minimum mass for this variant and does not consider local specification/trim or deletable options (specific to Movano). Weights are also subject to manufacturing tolerances (EU Legislation allows 5% tolerance).

GROSS VEHICLE WEIGHT (GVW)

The total permissible weight of a vehicle including payload and passengers, as shown on the manufacturer's plate.

GROSS COMBINATION WEIGHT (GCW)

The maximum permissible weight of a vehicle, including payload and passengers, combined with the total weight of any trailer it is towing. The maximum GCW weight limit is quoted on the vehicle plate and must not be exceeded.

PAYLOADS

The total permissible weight that can be carried without exceeding the vehicle's plated weight. Payloads do not include driver but do take into consideration specification/trim level.

Movano included are UK/Ireland specification (10kg) and deletable options such as Bulkhead (25kg); Sliding Doors (30kg each) and Spare Wheel (25kg) Weights are also subject to manufacturing tolerances (EU Legislation allows 5% tolerance). Payload does not consider any additional options that a customer may order.

ROOF LOADS

Movano roof load should not exceed 200kg including the weight of the roof rack/carrier. H3 are not permitted to carry roof loads

MAXIMUM TOWING WEIGHT

The maximum weight of any trailer and its load which may be towed within the limit of the vehicle's plated Gross Combination Weight (GCW). It is based on the ability of the vehicle – at full GCW – to restart on a 12% gradient, which is approximately 1 in 8.3, at sea level. At altitudes above 1500 metres, the engine output may drop with a corresponding reduction in towing capability. It is the operator's responsibility to ensure that the trailer noseweight does not cause the rear axle plated weight of the towing vehicle to be exceeded.

Always fit Opel towing attachments and accessories available from your Opel Commercial Vehicle Dealer. They are designed specifically for Opel models and carry a 12-month warranty.

LIGHT DUTY AND HEAVY DUTY CYCLES

For a Light Duty cycle (EC regulation 715/2007 with designation 'Euro 6') the emissions of the whole vehicle are evaluated whereas for Heavy Duty cycle (EC regulation 595/2009 with designation 'Euro VI') only the engine is bench tested. The requirement of which cycle is necessary is determined by the reference mass of the vehicle. In the case of Movano, reference mass calculations dictate that:

- N1 FWD and M1 FWD are approved as Light Duty
- N1 RWD, N2 RWD and M2 FWD are approved as Heavy Duty

When Euro 5 was previously introduced, there was an agreement between Member States and the Commission (Reference TEC 740/2011) that, assuming there was no alteration to the emissions system itself, a multi-stage build vehicle should be covered by the base vehicle emissions approval, irrespective of whether the reference mass had changed. The Department for Transport has confirmed that this interpretation will remain in place for Euro 6/VI.

To illustrate this better – a F3500 L3 H1 (130PS) Movano Chassis Cab is type approved as Light Duty (Euro 6). Regardless of any conversion to this vehicle and even if its reference mass transgresses above the 2840kg threshold, then it is still be covered by the original Light Duty cycle emissions. One situation where this may not apply is when a vehicle changes category from N1 (Commercial) to M1 (Passenger) during the process of conversion.

COMMERCIAL VEHICLE CATEGORIES

Differences between M1/N1 and M2/N2 (Vehicles with GVW above 3500kg)

Category M: Passenger carriers

Category M1: Vehicles designed and constructed for the carriage of passengers and comprising no more than eight seats in addition to the driver's seat.

Category M2: Vehicles designed and constructed for the carriage of passengers, comprising more than eight seats in addition to the driver's seat, and having a maximum mass not exceeding 5 tonnes.

Category N: Goods vehicles

Category N1: Vehicles designed and constructed for the carriage of goods and having a maximum mass not exceeding 3.5 tonnes.

Category N2: Vehicles designed and constructed for the carriage of goods and having a maximum mass exceeding 3.5 tonnes but not exceeding 12 tonnes.

Specific differences, all M2/N2 require the following:

Speed limiter: All M2/N2 vehicles are legally required to be speed limited. M2 to 100km/h (62mph) and N2 to 90km/h (56mph).

Driver licence: Commercial vehicles with GVW greater than 3.5 tonnes have different license requirements. For any new drivers C1 category

is necessary. Under some circumstances (social purposes for a non-commercial body) it is possible to drive a minibus without a D1 entitlement (Minibus) however eligibility for this exemption should be confirmed with Road Safety Authority (RSA).

Driver CPC: Driver Certificate of Professional Competence mandates 35 hours of periodic training every 5 years to maintain licence (from September 2014).

Tachograph: It is a legal requirement to administer the activities of drivers subject to the EU or AETR drivers' hours rules, and also record the vehicle's speed, distance and time. A Smart Card is required for digital tachograph and these are available from the RSA. The tachograph of a new vehicle must be calibrated within two weeks of first registration.

Operator's Licence: This may also be required to ensure that vehicles are kept safe and in good condition at all times. Specifically for M2, PSV (public service vehicle) operator's licence is required. Exemptions in some circumstances may be permitted but this should always be confirmed with RSA.

MOT Testing: M2/N2 must be tested each year, and vehicle presented with a completed Certificate of Conformity (CoC).